

# **8600 Ring Scanner**

---

## **User's Guide**

---

## ***Disclaimer***

Honeywell International Inc. ("HII") reserves the right to make changes in specifications and other information contained in this document without prior notice, and the reader should in all cases consult HII to determine whether any such changes have been made. The information in this publication does not represent a commitment on the part of HII.

HII shall not be liable for technical or editorial errors or omissions contained herein; nor for incidental or consequential damages resulting from the furnishing, performance, or use of this material.

This document contains proprietary information that is protected by copyright. All rights are reserved. No part of this document may be photocopied, reproduced, or translated into another language without the prior written consent of HII.

© 2008-2015 Honeywell International Inc. All rights reserved.

Web Address: [www.honeywellaidc.com](http://www.honeywellaidc.com)

## ***Trademarks***

RFTerm is a trademark or registered trademark of EMS Technologies, Inc. in the United States and/or other countries.

The Bluetooth® word mark and logos are owned by the Bluetooth SIG, Inc.

Symbol® is a registered trademark of Symbol Technologies. MOTOROLA, MOTO, MOTOROLA SOLUTIONS and the Stylized M Logo are trademarks or registered trademarks of Motorola Trademark Holdings, LLC and are used under license.

Other product names or marks mentioned in this document may be trademarks or registered trademarks of other companies and are the property of their respective owners.

## ***Patents***

For patent information, please refer to [www.hsmpats.com](http://www.hsmpats.com).

---



# Table of Contents

## Chapter 1 - Ring Scanner Agency Compliance

Label Locations .....	1-1
Laser Label .....	1-1
Laser Safety Statement .....	1-1
Beam Divergence .....	1-2
FCC Part 15 Statement.....	1-2
Canadian Compliance.....	1-3
CE Mark .....	1-3
Honeywell Scanning & Mobility Product Environmental Information.....	1-3
Dealer License - Republic of Singapore .....	1-3

## Chapter 2 - Getting Started

Overview .....	2-1
About this Guide .....	2-1
Out of the Box .....	2-1
Initial Setup .....	2-2
Hardware Setup .....	2-2
Components.....	2-2
Ring Imager / Ring Scanner.....	2-2
Ring Imager / Ring Scanner for Dolphin 70e Black in Wearable Sled.....	2-2
Ring Imager / Ring Scanner for HX2 and HX3.....	2-2
Assembly .....	2-3
Determine Left or Right Orientation .....	2-3
Adjusting the Ring Device Strap .....	2-3
Connect to Terminal.....	2-4
Dolphin 70e in Wearable Sled.....	2-4
Connect.....	2-4
Disconnect .....	2-4
HX2 / HX3 .....	2-4
Removing / Replacing the Trigger Module.....	2-5
Remove Finger Strap Assembly .....	2-5
Replace Trigger Module.....	2-5
How To Scan a Bar Code .....	2-6
Scan a Linear Bar Code.....	2-6
Good Read / Bad Read Indicators .....	2-6
Factors That May Impact Scanner Performance .....	2-7
Bar Code Scanning Help .....	2-7
Miscellaneous Programmable Bar Codes.....	2-8
Beep After Good Decode .....	2-8
Beeper Frequency Adjustment.....	2-8
Event Reporting .....	2-8
LED Mode .....	2-8
Return to Factory Default Settings.....	2-9

## Chapter 3 - 1D Laser Scanner Programming Bar Codes

---

Introduction.....	3-1
Aiming Modes.....	3-2
SE955 Ring Scanner.....	3-2
Prefix / Suffix.....	3-2
Set Default Parameter.....	3-6
Scanner Parameters – General.....	3-7
Aim Duration.....	3-7
Bi-Directional Redundancy.....	3-7
Disable All Symbologies.....	3-8
Data Options.....	3-8
Prefix and Suffix.....	3-8
Prefix.....	3-8
Suffix 1.....	3-8
Suffix 2.....	3-9
Scan Data Transmission Format.....	3-9
Transmit Code ID Character.....	3-11
Transmit No Code ID Character.....	3-11
Transmit Symbol Code ID Character.....	3-11
Transmit AIM Code ID Character.....	3-12
Laser On Time.....	3-14
Linear Code Type Security Level (Redundancy Level).....	3-15
Parameter Pass Through.....	3-16
Parameter Scanning.....	3-16
Power Mode.....	3-17
Scan Angle (SE955 only).....	3-17
Simple Serial Interface (SSI) Options.....	3-18
SSI Defaults.....	3-18
Beep on BEL.....	3-18
Baud Rate.....	3-18
Decode Data Packet Format.....	3-19
Host Character Time-out.....	3-19
Intercharacter Delay.....	3-20
Software Handshaking.....	3-22
Stop Bit Select.....	3-23
Time-out Between Decodes, Same Symbol.....	3-23
Transmit “No Read / Decode” Message.....	3-24
Trigger Mode.....	3-25
Scanner Parameters – Bar Code Type Specific.....	3-26
Chinese 2 of 5.....	3-26
Codabar.....	3-27
CLSI Editing.....	3-27
NOTIS Editing.....	3-28
Set Lengths for Codabar.....	3-28
One Discrete Length (Parameter L1).....	3-28
Two Discrete Lengths (Parameter L2).....	3-29
Length Within Range.....	3-29
Any Length.....	3-29
Code 11.....	3-30

---

Set Lengths for Code 11 .....	3-30
One Discrete Length (Parameter L1) .....	3-30
Two Discrete Lengths (Parameter L2) .....	3-30
Length Within Range .....	3-31
Any Length .....	3-31
Code 11 Check Digit Verification .....	3-32
Transmit Code 11 Check Digits .....	3-32
Code 128 .....	3-33
GS1-128 (formerly UCC/EAN-128) .....	3-33
ISBT-128 .....	3-34
Lengths for Code 128 .....	3-34
Code 39 .....	3-35
Code 39 Check Digit Verification .....	3-35
Code 32 Prefix .....	3-36
Convert Code 39 to Code 32 .....	3-36
Code 39 Full ASCII Conversion .....	3-37
Set Lengths for Code 39 .....	3-37
Code 39 One Discrete Length (Parameter L1) .....	3-37
Code 39 Two Discrete Lengths (Parameter L2) .....	3-38
Code 39 Length Within Range .....	3-38
Code 39 Any Length .....	3-38
Transmit Code 39 Check Digit .....	3-39
Trioptic Code 39 .....	3-39
Code 93 .....	3-40
Set Lengths for Code 93 .....	3-40
One Discrete Length (Parameter L1) .....	3-40
Two Discrete Lengths (Parameter L2) .....	3-41
Length Within Range .....	3-41
Any Length .....	3-41
Discrete 2 of 5 .....	3-42
Set Lengths for Discrete 2 of 5 .....	3-42
One Discrete Length (Parameter L1) .....	3-42
Two Discrete Lengths (Parameter L2) .....	3-43
Length Within Range .....	3-43
Any Length .....	3-43
Interleaved 2 of 5 .....	3-44
I 2 of 5 Check Digit Verification .....	3-44
Convert I 2 of 5 to EAN-13 .....	3-45
Set Lengths for I 2 of 5 .....	3-45
One Discrete Length (Parameter L1) .....	3-45
Two Discrete Lengths (Parameter L2) .....	3-46
Length Within Range .....	3-46
Any Length .....	3-46
Transmit I 2 of 5 Check Digit .....	3-47
MSI Plessey .....	3-48
MSI Plessey Check Digit Algorithm .....	3-48
MSI Plessey Check Digits .....	3-49
Set Lengths for MSI Plessey .....	3-49

One Discrete Length (Parameter L1) .....	3-49
Two Discrete Lengths (Parameter L2) .....	3-50
Length Within Range .....	3-50
Any Length .....	3-50
Transmit MSI Plessey Check Digit .....	3-51
UPC/EAN.....	3-52
UPC-A.....	3-52
UPC-E.....	3-52
UPC-E1.....	3-53
EAN-8 .....	3-53
EAN-13 .....	3-54
Bookland EAN .....	3-54
Bookland ISBN Format .....	3-55
Check Digits.....	3-55
Transmit UPC-A Check Digit .....	3-55
Transmit UPC-E Check Digit .....	3-56
Transmit UPC-E1 Check Digit .....	3-56
Conversions.....	3-57
Convert UPC-E to UPC-A .....	3-57
Convert UPC-E1 to UPC-A .....	3-57
Convert EAN-8 to EAN-13 Type .....	3-58
Preambles.....	3-59
UPC-A Preamble .....	3-59
UPC-E Preamble .....	3-60
UPC-E1 Preamble .....	3-61
Supplementals .....	3-62
Decode UPC/EAN Supplementals .....	3-62
User-Programmable Supplementals .....	3-64
Decode UPC/EAN Supplemental Redundancy .....	3-64
EAN-8 Zero Extend.....	3-65
UCC Coupon Extended Code.....	3-65
UPC/EAN Security Level .....	3-66
GS1 DataBar (RSS) Codes .....	3-67
GS1 DataBar Omnidirectional (RSS-14) .....	3-67
GS1 DataBar Limited (RSS-Limited) .....	3-67
GS1 DataBar Expanded (RSS-Expanded) .....	3-68
Convert GS1 DataBar (RSS) to UPC/EAN .....	3-68
Appendix.....	3-69
Laser On Time (superseded).....	3-69
Scan Angle (SE955 only) superseded.....	3-69
Set Lengths for 1 2 of 5 (superseded) .....	3-70
One Discrete Length (Parameter L1).....	3-70
Two Discrete Lengths (Parameter L2).....	3-70
Length Within Range .....	3-71
Any Length.....	3-71
Keypad Number Symbols.....	3-72

## **Chapter 4 - 2D Laser Imager Programming Bar Codes**

---

Introduction.....	4-1
Set All Defaults/Cancel Bar Codes.....	4-5
Enable / Disable Parameter Scanning.....	4-6
Imager Parameters – General.....	4-6
Decode Session Timeout.....	4-6
Decode Aiming Pattern.....	4-7
Decoding Autoexposure.....	4-7
Decoding Illumination.....	4-8
Focus Mode.....	4-9
LED Illumination.....	4-10
Operational Mode.....	4-11
Power Mode.....	4-12
Presentation Mode Session Timeout.....	4-12
Time Delay to Low Power Mode.....	4-13
Time-out between Decodes, Same Symbol.....	4-14
Trigger Modes.....	4-15
Report Version.....	4-16
Transmit Code ID Character.....	4-16
Transmit No Code ID Character.....	4-16
Transmit Symbol Code ID Character.....	4-17
Transmit AIM Code ID Character.....	4-18
Prefix / Suffix Values.....	4-22
Suffix 1.....	4-22
Suffix 2.....	4-22
Scan Data Transmission Format.....	4-23
Transmit “No Read” Message.....	4-25
UPC/EAN.....	4-26
UPC-A.....	4-26
UPC-E.....	4-26
UPC-E1.....	4-27
EAN-8/JAN-8.....	4-27
EAN-13/JAN-13.....	4-28
Bookland EAN.....	4-28
Bookland Format.....	4-29
Decode UPC/EAN/JAN Supplementals (2 and 5 digits).....	4-29
UPC/EAN/JAN Supplemental Redundancy.....	4-31
Transmit UPC-A Check Digit.....	4-31
Transmit UPC-E Check Digit.....	4-32
Transmit UPC-E1 Check Digit.....	4-32
UPC-A Preamble.....	4-33
UPC-E Preamble.....	4-34
UPC-E1 Preamble.....	4-35
Convert UPC-E to UPC-A.....	4-36
Convert UPC-E1 to UPC-A.....	4-36
EAN-8/JAN-8 Extend.....	4-37
UCC Coupon Extended Code.....	4-37
Code 128.....	4-38
UCC/EAN-128.....	4-38

---

---

ISBT-128.....	4-39
Code 39 .....	4-39
Trioptic Code 39 .....	4-40
Convert Code 39 to Code 32 .....	4-40
Code 32 Prefix .....	4-41
Set Length(s) for Code 39 .....	4-42
One Discrete Length (Parameter L1).....	4-42
Two Discrete Lengths (Parameter L2).....	4-42
Length Within Range .....	4-42
Any Length.....	4-43
Code 39 Check Digit Verification .....	4-43
Transmit Code 39 Check Digit.....	4-44
Code 39 Full ASCII Conversion.....	4-44
Code 93 .....	4-45
Set Lengths for Code 93.....	4-45
One Discrete Length (Parameter L1).....	4-45
Two Discrete Lengths (Parameter L2).....	4-46
Length Within Range .....	4-46
Any Length.....	4-46
Code 11 .....	4-47
Set Lengths for Code 11.....	4-47
One Discrete Length (Parameter L1).....	4-47
Two Discrete Lengths (Parameter L2).....	4-48
Length Within Range .....	4-48
Any Length.....	4-48
Code 11 Check Digit Verification .....	4-49
Transmit Code 11 Check Digits .....	4-49
Interleaved 2 of 5 (ITF) .....	4-50
Set Lengths for I 2 of 5 .....	4-50
One Discrete Length (Parameter L1).....	4-50
Two Discrete Lengths (Parameter L2).....	4-51
Length Within Range .....	4-51
Any Length.....	4-51
I 2 of 5 Check Digit Verification.....	4-52
Transmit I 2 of 5 Check Digit .....	4-52
Convert I 2 of 5 to EAN 13.....	4-53
Discrete 2 of 5 (DTF) .....	4-53
Set Lengths for Discrete 2 of 5 .....	4-54
Two Discrete Lengths (Parameter L2).....	4-54
Length Within Range .....	4-55
Any Length.....	4-55
Codabar .....	4-56
CLSI Editing.....	4-56
NOTIS Editing.....	4-57
Set Lengths for Codabar.....	4-57
One Discrete Length (Parameter L1).....	4-57
Two Discrete Lengths (Parameter L2).....	4-58
Length Within Range .....	4-58



Any Length.....	4-58
MSI .....	4-59
Set Length(s) for MSI.....	4-59
Two Discrete Lengths (Parameter L2).....	4-60
Length Within Range .....	4-60
Any Length.....	4-60
MSI Check Digits .....	4-61
Transmit MSI Check Digit .....	4-61
MSI Check Digit Algorithm.....	4-62
Postal Codes .....	4-62
US Postnet.....	4-62
US Planet.....	4-63
UK Postal.....	4-63
Transmit UK Postal Check Digit .....	4-64
Japan Postal.....	4-64
Australian Postal.....	4-65
Dutch Postal .....	4-65
Transmit US Postal Check Digit .....	4-66
4 State Postal .....	4-66
GS1 DataBar (RSS).....	4-67
GS1 DataBar Omnidirectional (RSS-14) .....	4-67
GS1 DataBar Limited (RSS Limited) .....	4-67
GS1 DataBar Expanded (RSS Expanded) .....	4-68
Convert GS1 DataBar (RSS) to UPC/EAN .....	4-68
Composite .....	4-69
Composite CC-C.....	4-69
Composite CC-A/B .....	4-69
Composite TLC-39.....	4-70
UPC Composite Mode.....	4-70
2D Symbolologies .....	4-71
Aztec.....	4-71
Aztec Inverse .....	4-72
PDF417.....	4-72
MicroPDF417.....	4-73
Code 128 Emulation .....	4-73
Data Matrix .....	4-74
Data Matrix Inverse.....	4-74
Maxicode .....	4-75
MicroQR.....	4-75
QR Code.....	4-76
QR Inverse.....	4-76
Redundancy Level.....	4-77
Security Level .....	4-79
Intercharacter Gap Size.....	4-80
Imager Keypad Number Symbols.....	4-81

## **Chapter 5 - Decode Zones**

Introduction.....	5-1
-------------------	-----

---

Ring Laser .....	5-1
Ring Imager .....	5-2
PL4407 Near Focus Decode Distances.....	5-2
PL4407 Far Focus Decode Distances .....	5-2
PL4407 Toggled Focus Decode Distances .....	5-3
PL4407 Decode Distances in Darkness .....	5-3

**Chapter 6 - Technical Specifications**

Ring Scanner / Imager.....	6-1
Technical Specifications .....	6-1
Environmental Specifications.....	6-1
ASCII Character Equivalents.....	6-1

**Chapter 7 - Customer Support**

Technical Assistance.....	7-1
Product Service and Repair.....	7-1
Limited Warranty .....	7-1

# Ring Scanner Agency Compliance

Ring bar code decoders meet or exceed the requirements of all applicable standards organizations for safe operation. However, as with any electrical equipment, the best way to ensure safe operation is to operate them according to the agency guidelines that follow. Read these guidelines carefully before using your Ring Scanner.

This documentation is relevant for the following models: 8600 series (861x, 862x) Ring Scanners.

## Label Locations

### Left Side of Scanner head

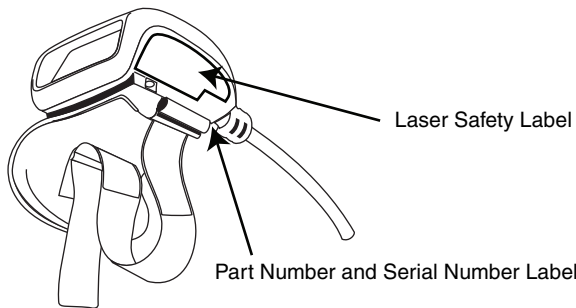

### Right Side of Scanner Head

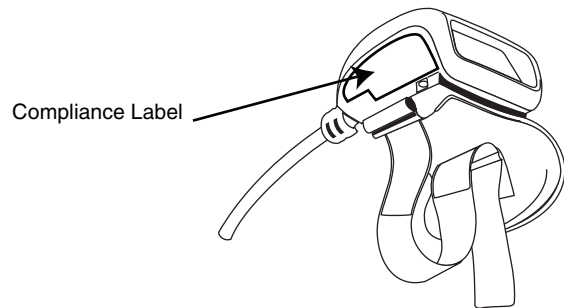

## Laser Label

If the following label is attached to your ring bar code decoder, it indicates the ring bar code decoder contains an engine with a laser aimer:

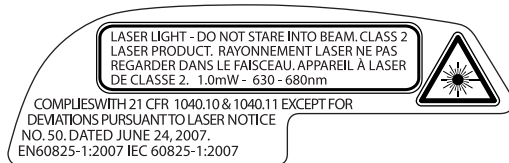

## Laser Safety Statement

This device has been tested in accordance with and complies with IEC60825-1:2007 and EN60825-1:2007). Complies with 21 CFR 1040.10 and 1040.11, except for deviations pursuant to Laser Notice No. 50, dated June 24, 2007.

**LASER LIGHT, DO NOT STARE INTO BEAM, CLASS 2 LASER PRODUCT, 1.0 mW MAX OUTPUT: 630-680nm.**

### Laser Warnings

- Do not look into the laser's lens.
- Do not stare directly into the laser beam.
- Do not remove the laser caution labels from the Ring Scanner ring bar code decoders.
- Do not connect the laser bar code aperture to any other device. The laser bar code aperture is certified for use with either the HX2/HX3 or the Dolphin 70e Black in the Honeywell Wearable Solution only.

<p>Caution:</p> 	<p>Laser radiation when open. Read the caution labels. Use of controls, adjustments or performance of procedures other than those specified herein may result in hazardous radiation exposure.</p>
---	--

## Beam Divergence

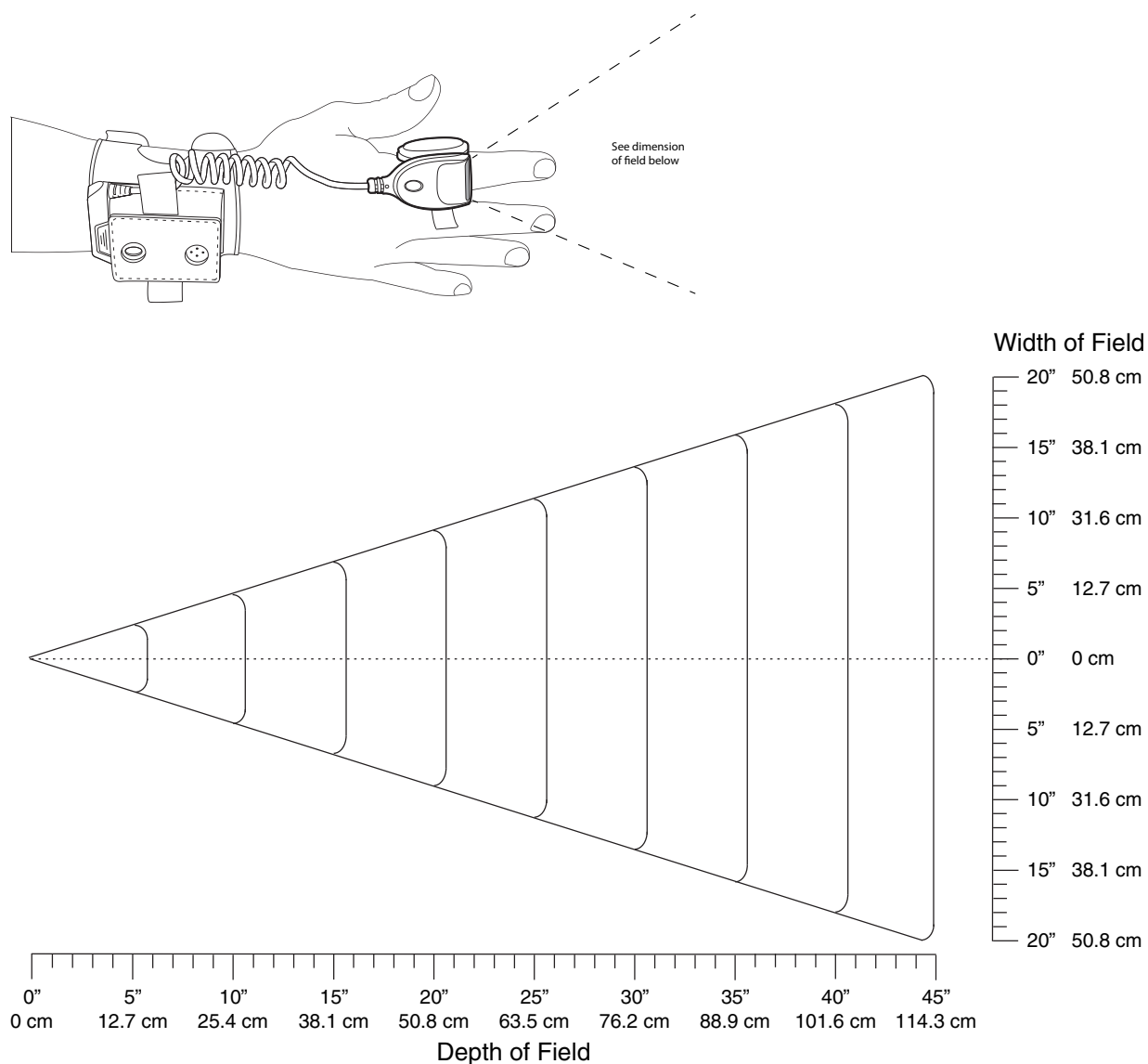

## FCC Part 15 Statement

This device has been tested and found to comply with the limits for a Class B digital device, pursuant to Part 15 of the FCC Rules.

These limits are designed to provide reasonable protection against harmful interference in a residential installation.

This equipment generates, uses and can radiate radio frequency energy and, if not installed and used in accordance with the instructions, may cause harmful interference to radio communications.

## Canadian Compliance

This ISM device complies with Canadian RSS-210.

Operation is subject to the following conditions:

1. This device may not cause harmful interference.
2. This device must accept any interference received, including interference that may cause undesired operation.

This Class B digital apparatus complies with Canadian ICES-003.

### IMPORTANT NOTE:

Radiation Exposure Statement:

This equipment complies with IC radiation exposure limits set forth for an uncontrolled environment. End users must follow the specific operating instructions for satisfying RF exposure compliance. To maintain compliance with IC RF exposure compliance requirements, please follow operation instruction as documented in this manual.

## CE Mark

The CE marking indicates compliance with the following directives:

- 1995/5/EC R&TTE
- 2011/65/EU RoHS (Recast)

In addition, complies to 2006/95/EC Low Voltage Directive, when shipped with recommended power supply. European contact::



Hand Held Products Europe BV  
Nijverheidsweg 9-13  
5627 BT Eindhoven  
The Netherlands

Honeywell shall not be liable for use of our product with equipment (i.e., power supplies, personal computers, etc.) that is not CE marked and does not comply with the Low Voltage Directive.

## Honeywell Scanning & Mobility Product Environmental Information

Refer to [www.honeywellaidc.com/environmental](http://www.honeywellaidc.com/environmental) for the RoHS / REACH / WEEE information.

## China RoHS

 有毒有害物质名称及含量的标识 (Names and Content of Hazardous Substances or Elements)						
部件名称 (Parts Name)	有毒有害物质或元素 (Toxic and Hazardous Substances or Elements)					
	铅 (Pb)	汞 (Hg)	镉 (Cd)	六价铬 (Cr6+)	多溴联苯 (PBB)	多溴二苯醚 (PBDE)
扫描模块 (Scanner Module)	x	o	o	o	o	o
印刷电路部件 (PCA)	x	o	o	o	o	o
外壳 (Housing)	x	o	o	o	o	o
连接线 (Cable)	x	o	o	o	o	o

o: 表示该有毒有害物质在该部件所有均质材料中的含量均在 SJ/T11363-2006 标准规定的限量要求以下 (Indicates that this toxic or hazardous substance contained in all of the homogeneous materials for this part is below the limit requirement in China's SJ/T11363-2006)  
x: 表示该有毒有害物质至少在该部件的某一均质材料中的含量超出 SJ/T11363-2006 标准规定的限量要求 (Indicates that this toxic or hazardous substance contained in at least one of the homogeneous materials for this part is above the limit requirement in China's SJ/T11363-2006)

## Dealer License - Republic of Singapore

Complies with  
IDA Standards  
DA103458



# Getting Started

## Overview

This guide contains installation and configuration instructions for the Honeywell 8650 Ring Scanner. The Ring Scanner is available with either a 1D laser scanner or 2D laser imager.

Bar code decoding laser engines and imager engines are designed to read, decode and collect bar coded data from any nearby compatible bar code label that is visible and on printed media.

The ring scanner consists of a ring decoder with a cable to tether to a Honeywell HX2 or HX3. The HX2 or HX3 provides power to the ring decoder. The hand strap assembly is designed to be worn on the back of either hand..

The Ring Scanner is compatible with the Honeywell HX2 and HX3. The ring scanner communicates to the serial port on the HX2 or HX3 via the cable connection.

For information about other scanners, such as internal scanners, scanners connected to a COM port or Bluetooth scanners, refer to [www.honeywellaidc.com](http://www.honeywellaidc.com) or the scanner manufacturer's website.

## About this Guide

This guide provides instruction for the end-user or system administrator to follow when setting up a new Ring Scanner bar code decoder. This guide includes all programming bar codes and decode zones.

## Out of the Box

After you open the shipping carton verify it contains the following items:

- Ring bar code decoder
- Hand strap
- Quick Start Guide

If you ordered accessories for the 8600-series Ring Scanner, verify they are also included with the order. Keep the original packaging material in the event the Ring Scanner should need to be returned for service. For details, see [Product Service and Repair](#) (page 7-1).

---

## Initial Setup

Following are the steps you might take when setting up a new Ring Scanner. More instruction for each step is listed later in this guide. Contact [Customer Support](#) (page 7-1) if you need additional help.

Accessory installation or removal should be performed on a clean, well-lit surface. When necessary, protect the work surface, the Ring Scanner, and components from electrostatic discharge.

### Hardware Setup

1. Determine which hand will contain the assembly. See [Determine Left or Right Orientation](#) (page 2-3).
2. Connect the ring cable connector to the body worn computer. See [Connect to Terminal](#) (page 2-4).

## Components

### Ring Imager / Ring Scanner

The ring imager can scan and decode 1D and 2D bar codes. The imager has three small illumination LEDs at the top of the scan window or aperture.

The ring scanner can scan and decode 1D bar codes. The scanner does not have illumination LEDs.

The ring sends the collected bar code data to the mobile computer for processing.

Do not touch, push against or brace your finger on the scan aperture at any time.

When new, there is a clear, tabbed protective film covering the ring decoder scan window. Remove and discard the clear, tabbed protective film before scanning a bar code.

#### ***Ring Imager / Ring Scanner for Dolphin 70e Black in Wearable Sled.***

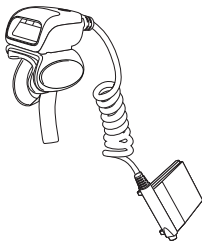

Ring Imager

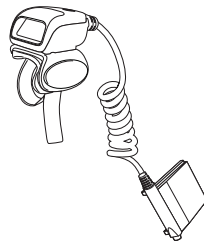

Ring Scanner

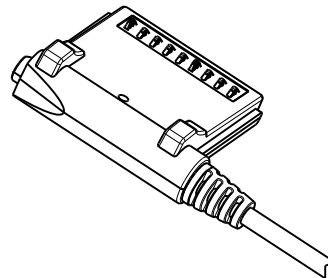

Cable Connector

#### ***Ring Imager / Ring Scanner for HX2 and HX3.***



Ring Imager



Ring Scanner

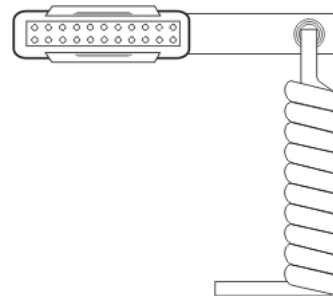

Cable Connector



---

## Assembly

### **Determine Left or Right Orientation**

Determining whether to wear the module assembly on the left or right has a bearing on how the ring cable is attached to the module and the ring to the finger. The ring cable should not cross over or under the hand.

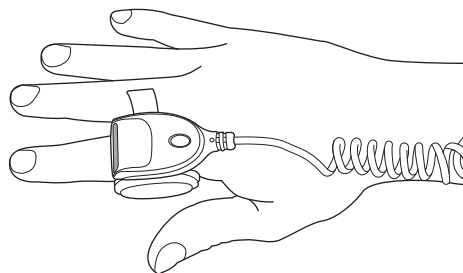
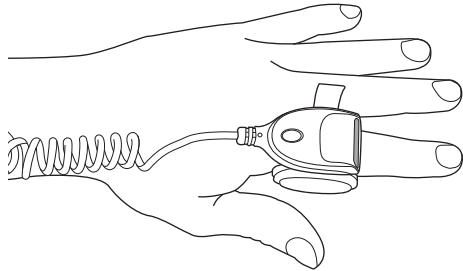

### **Adjusting the Ring Device Strap**

The ring device finger loop is located under the ring device. The ring device has a built-in quick disconnect designed for safety hazards. The quick disconnect is not intended for daily removal of the ring device.

1. Pull gently on the end of the finger loop strap to separate the hook and loop fabric.
2. Slide your finger into the opened loop under the ring device.

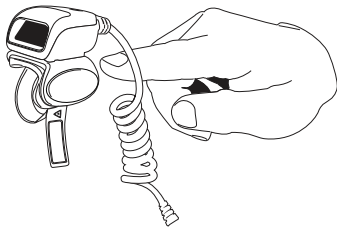

3. Grasp the end of the finger loop strap and gently pull to loosen then tighten the finger strap until the ring device is comfortably snug and the scan aperture is in the desired location.
4. Secure the ring strap at the desired location by pressing the hook fabric to the loop fabric on the strap surrounding the finger.

---

## Connect to Terminal

### Dolphin 70e in Wearable Sled

#### Connect

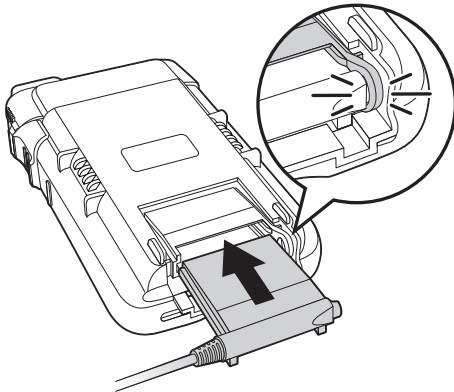

1. Slide the ring scanner cable connector into the bottom of the sled until the connector ring clicks shut.

#### Disconnect

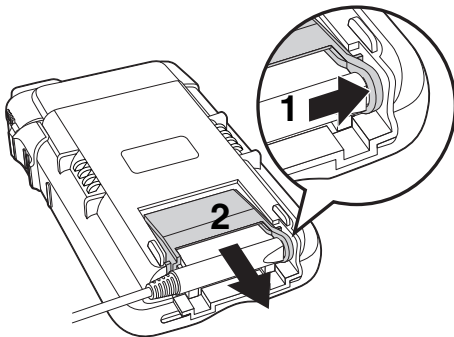

1. To eject the ring scanner, open the connector ring with one hand, pulling toward the outside of the sled.
2. Push the ring scanner connector out of the sled.

### HX2 / HX3

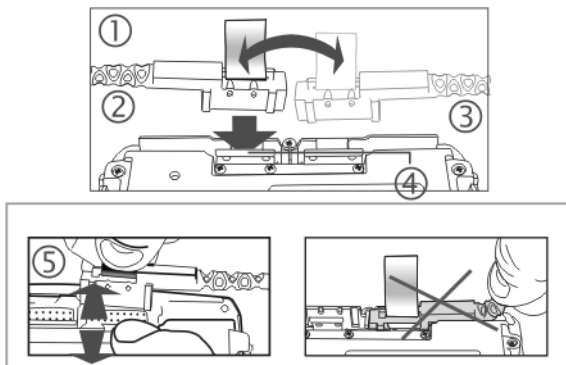

1. Connect
2. Ring on Left Hand
3. Ring on Right Hand
4. Press Down
5. Remove

When you want to switch connectors from left to right, or vice versa, first gently press downward on the Retaining Clip, then pinch and pull the cable connector (not the cable!) straight up and away from the Ring Scanner. Do not use a metal object, or extreme force, to remove the cable connector from the Ring Scanner.

Re-connect cables and reassemble the Ring Scanner body-worn components.

---

## **Removing / Replacing the Trigger Module**

Equipment Needed: Phillips screwdriver with a blade diameter of 1/8" (.4mm). Not supplied.

**Caution:** Do not perform the following procedures if the ring bar code reader is tethered to a mobile computer. There is a possibility the Scan button may be pressed inadvertently and the laser beam emitted. Disconnect the ring scanner before attempting to remove or replace the trigger module.

Do not touch, push on or brace your finger against the scan aperture at any time.

Installing and removing accessories should be performed on a clean, well-lit surface. When necessary, protect the work surface, the mobile device, and components from electrostatic discharge.

A 20-pak of full Trigger assemblies is available. Contact [Customer Support](#) (page 7-1) for the latest updates and accessories.

### **Remove Finger Strap Assembly**

Fold the flexible liner back until the screw hole is visible.

Rotate the trigger module until the black screw is visible.

1. Using a Phillips screwdriver with a blade diameter of 1/8" (.4mm) loosen the black screw counter-clockwise and set the screw aside in a safe place.
2. Remove the trigger module.

### **Replace Trigger Module**

1. Position the trigger module on the base of the Ring Scanner, making sure the empty screw hole is visible.
2. Find the tiny black screw that you removed previously.
3. Using a Phillips screwdriver with a blade diameter of 1/8" (.4mm) rotate the black screw clockwise until the trigger module is secured to the ring scanner.
4. Install the finger strap.
5. Removing / Replacing the Ring Finger Strap Assembly

*Note: Do not pull on the finger strap or the flexible liner to remove the finger strap assembly. This quick disconnect function is designed for occasional safety hazards and is not intended for daily removal.*

Using the Quick Disconnect Function, grasp the finger strap and pull the finger strap out and away from the ring scanner.

Before attaching the finger strap to the trigger module, thread the finger strap first through the hinge, then under and over the pin next to the scan button.

It should slide easily.

Cleaning the Beam Aperture

*Note: These instructions are for components made of glass. If there is a removable protective film sheet on the beam aperture, remove the film sheet before cleaning and before first use.*

Keep fingers and rough, sharp or abrasive objects away from the beam aperture.

If the aperture becomes soiled or smudged, clean only with a standard household cleaner such as Windex® without vinegar or use Isopropyl Alcohol.

Do not use paper towels or harsh-chemical-based cleaning fluids since they may result in damage to the aperture surface. Use a clean, damp, lint-free cloth. Do not scrub optical surfaces.

If possible, clean only those areas which are soiled. Lint/particulates can be removed with clean, filtered canned air.

---

## How To Scan a Bar Code

The function to use an imager like a camera (or for OCR decoding) is not supported. Using a Continuous Scan option, if available, to scan programming bar codes is not supported.

The linear bar codes in this guide were created using Code 128 symbology. Your Ring Scanner has been set up by Honeywell to automatically read / decode Code 128 bar codes.

Using the bar codes contained in this guide, you can change bar code reader system parameters or reset all parameters to their factory default values.

It is important to use the correct bar codes when programming the scanner/imager:

- [1D Laser Scanner Programming Bar Codes](#) (page 3-1)
- [2D Laser Imager Programming Bar Codes](#) (page 4-1)

All bar code reader parameters are programmed into and stored by the bar code reader engine.

If this guide is not in print form, locate the page in this electronic guide that contains the bar code you wish to use. Print the page on white paper using a 600dpi laser printer (or equivalent).

Print the page containing the Reset and Cancel bar codes as well as the page containing the A – F and 0 – 9 number bar codes.

Select the parameter you want to scan. If this guide is in print form, lay it flat on a table or propped up at an angle.

### Scan a Linear Bar Code



Holding the beam aperture approximately 3 – 12 inches away from the bar code, aim the scan aperture toward the selected bar code. Refer to the bar code reader engine type in Decode Zones later in this guide for recommended decode ranges.

Press the Scan button. Align the scan beam so that the bar code is centered within the beam. The beam must cross the entire bar code. Move the bar code reader towards or away from the bar code so that the bar code takes up approximately two-thirds the width of the beam.

Refer to the recommended *decode zones* for the ring bar code reader engine if you are having difficulty with this process.

Do not position the scan aperture exactly perpendicular to the bar code being read. In this position, light can bounce back into the scan aperture, and possibly prevent a successful decode.

### Good Read / Bad Read Indicators

The scan On indicator illuminates (usually red) when the beam is on. Following a bar code scan and “good read” the indicator turns green indicating a successful scan. The connected mobile device may also beep or play a WAV file while decoding the signal from the ring scanner.

The laser beam and scan On indicator automatically turn off after a successful or unsuccessful read and the bar code reader is ready to scan again.

---

## **Factors That May Impact Scanner Performance**

Successful scanning range of a bar code decoder is dependent upon many outside influences including size of the bar code, quality of the bar code printing, material the bar code is printed on, condition of the scan lens (scratches) and angle of the beam aperture relative to the bar code label. Any of these factors may result in having to re-scan the label from a different distance or angle.

### *Bar Code Quality*

Check the bar code for marks or physical damage e.g., ripped label, missing section, correct size for the scanner being used, etc.

In general, the bigger the bar code the further the distance from which it can be read. If the bar code is smaller than the specified size for the scanner being used, the distance, in almost all cases, will shrink.

Large bar codes can be scanned at the maximum distance. Hold the scanner closer to small bar codes (or with bars that are very close together).

Do not position the scanner exactly perpendicular to the bar code being scanned. In this position, light can bounce back into the scan aperture, and possibly prevent a successful decode.

### *Bar Code Source*

*Using a graphics program to clip/copy a bar code from an online file (e.g., Adobe, Word) will copy the bar code at your monitor's dot per inch setting, a level too low for successful bar code scanning.*

*Copy a Bar Code -- Use your browser's right-click menu to download an individual bar code using the Save Picture As option. Save the picture to a location on your computer's hard drive. The individual bar code can be added, as a file, to any delivery vehicle e.g., email, Word document.*

### *Bar Code Symbology*

Bar codes such as UPC codes and Code 128 are more complex than Code 39 and Interleaved 2 of 5. When attempting to get the maximum read distance possible, particularly with reflective labels, use Code 39. The use of Code 128 or other more complex symbologies will almost always result in a reduction in maximum read distance. Scanner maximum distances (from Decode Zones) when symbologies other than Code 39 are used are not supported.

### *Lens Damage*

A scratched scan beam aperture can impact read rates and distances. Beam apertures should be inspected frequently, particularly if scanning quality or distances get worse over time.

### *Ambient Lighting*

High ambient conditions, particularly outdoor environments, will produce enough light to somewhat "blind" the scanner. This will result in shorter read distances.

### *Temperature*

While small deviations from room temperature will have no impact on scanner performance, severe conditions like those found in freezers will have a negative impact on both the distance scanners can read and the speed the read is acquired.

Some scanner engines contain protection circuitry that shuts the scanner down in temperatures that exceed the recommended operating temperature.

## **Bar Code Scanning Help**

### *Notes*

- Decrease decode time by disabling unused bar code types. The scan engine can store several different bar code symbologies at the same time. This means the Ring Scanner is able to scan a Code 39 bar code, then an Interleaved 2 of 5 bar code, then a different bar code without requiring a parameter reset.
- The mobile device Scanner (or Data Collection Wedge) panel parameters are applied to the data resulting from successful bar code scans sent to the host (e.g., Thor VM2) for processing. The wedge panel does not affect or change the programming bar code parameter settings in this guide.
- After scanning the Reset All to default (or equivalent) bar code with the tethered ring scanner, the next step is to open the Scanner (or Data Collection Wedge) panel on the host, click the OK button and then close the panel. This action will synchronize all scanner formats.

---

**Issue:**

Bar codes on the printed page are too compact to be scanned, especially with a long range scanner.

**Solution 1 - Printing Adobe Acrobat PDF File Pages:**

When printing pages from an Adobe Acrobat PDF file, there is a difference between laser printer types and how they handle some Adobe Acrobat print functions – specifically, the “shrink to fit” option on the Print Options screen. Before clicking Print, make sure the “Shrink oversized pages to paper size” checkbox is unchecked. If the bar code is still too small to be read by the scanner engine, run the printed page through the laser printer again using the laser printer’s Zoom feature until the bar code is large enough to scan satisfactorily.

When printing pages from an on-line Web page, run the printed page through a laser copier using the laser copier’s Zoom feature until the bar code is large enough to scan satisfactorily.

**Solution 2 - Printing from a Browser Page:**

Use the Print button on the browser menu. Bar codes must be printed at 600 dots per inch (dpi) before they can be successfully scanned with a bar code reader.

## ***Miscellaneous Programmable Bar Codes***

### ***Beep After Good Decode***

Audible scan progress indicators are generated by the scanner driver on mobile devices, not the bar code decoder engine. Use the Windows wedge panel options to set up the mobile device audible indicators.

### ***Beeper Frequency Adjustment***

Audible scan progress indicators are generated by the scanner driver on mobile devices, not the bar code decoder engine. Use the Windows wedge panel options to set up the mobile device audible indicators.

### ***Event Reporting***

Mobile devices aren’t designed to process events triggered by a bar code decoder engine. Events are processed by the operating system resident on the mobile device. Use Windows Control Panel options to set up the mobile device event reporting parameters.

### ***LED Mode***

This parameter is disabled/inactive as the scan LEDs are controlled by the scanner driver, not the scanner engine.

---

## ***Return to Factory Default Settings***

Choose one of the following methods to restore factory defaults in the module, scan the [Set Default Parameter](#) (page 3-6) or [Set All Defaults/Cancel Bar Codes](#) (page 4-5) bar code.

***Important:*** - HX2 and HX3 only:

After resetting the module to factory default settings, the next step is to open the bar code wedge panel on the host mobile device collecting the scanned data. Click the OK button to close the panel. This action will synchronize all scanner formats.





## 1D Laser Scanner Programming Bar Codes

### Introduction

These bar codes, explanations and instructions are for programming the SE955 laser scanner engine in your ring scanner. Do not scan the bar codes in this section with any other imager or laser engine.

*Note: A ring scanner does not have beep / audio capability.*

Assumption: The user is familiar with Windows on-screen functions.

Scan engine manufacturers may offer more bar codes and options than are contained in this chapter. Note that the bar codes in this chapter are only those supported by Honeywell and the mobile devices it manufactures or supports. Contact [Customer Support](#) (page 7-1) if you need help using the bar codes in this guide.

**To change a parameter value:** Scan the appropriate bar code in this section. The new value replaces the standard default value in memory.

The following bar code symbologies are supported on the Ring Scanner:

Symbology
DataBar (RSS)
GS1Chinese 2 of 5
Codabar
Code 11
Code 128
Code 39
Code 93
Discrete 2 of 5
Interleaved 2 of 5
MSI Plessey
GS1 Databar (RSS) and Composite Codes
UPC/EAN
UPC-A
UPC-E
UPC-E1
EAN-8
EAN-13

---

## Aiming Modes

There are many aiming “modes” for laser bar code scanners – aiming dots, aiming patterns, aim duration, etc. All aiming “modes” concern the length of time the beam is sent out, how wide the beam is and what happens when the timer expires. The terms are used interchangeably and may be confusing for the novice bar code laser scanner user.

*Note: Decoding algorithms released by the bar code engine manufacturer often change upon each new release. Programming parameters that were available at one release may not be available upon a later software release. Honeywell supports the programming bar codes for the specific engines in this guide only.*

### SE955 Ring Scanner

The scan engine can have its aiming beam/aiming dot setup using these bar codes:

- Use [Laser On Time](#) (page 3-14)
- [Aim Duration](#) (page 3-7), and
- [Scan Angle \(SE955 only\)](#) (page 3-17)

#### Aiming Dot Help

How to get an aiming dot when there is no “Aiming Dot” parameter:

Set *Aim Duration* to .5 seconds and an aiming “dot” is sent while the scan trigger is held down. When the timer expires, the aiming beam widens and the bar code is read.

## Prefix / Suffix

Ring decoder engine prefix and suffix parameters should not be set, changed, or reset using the Prefix and Suffix bar codes shown in this section. When the Ring Scanner module is reset to defaults, the prefix and suffix settings revert to their default values and need to be scanned again. Use the ScanWedge NGW Power Tool (Dolphin 70e) or Scanner control panel (HX2 or HX3) in the host computer to store prefix and suffix values.

Refer to the host computer’s user guide for information and instruction on setting up the following scanner parameters:

- Enable/Disable decoding sounds
- Imager LED Illumination
- COM1 Serial Parameters
- Code ID: AIM, Symbol, Custom
- Symbology Settings including Prefix/Suffix
- Control Character Mapping
- Custom Identifiers
- Pre-Configured Default Values

Ring Scanner Setting 955	Default
<a href="#">Set Default Parameter</a> (page 3-6)	All Defaults
<b>Scanning Options</b>	
<a href="#">Aim Duration</a> (page 3-7)	0.0 sec
Aiming Mode	Not Supported
Beeper Volume	Not Supported
<a href="#">Bi-Directional Redundancy</a> (page 3-7)	Disable
<a href="#">Laser On Time</a> (page 3-14)	3.0 sec.
<a href="#">Linear Code Type Security Level (Redundancy Level)</a> (page 3-15)	1
<a href="#">Parameter Pass Through</a> (page 3-16)	Disable
<a href="#">Parameter Scanning</a> (page 3-16)	Enable
<a href="#">Power Mode</a> (page 3-17)	Low Power
Raster Expansion Rate	Not Supported
Raster Height	Not Supported

<b>Ring Scanner Setting 955</b>	<b>Default</b>
<a href="#">Scan Angle (SE955 only)</a> (page 3-17)	Wide
Scanning Mode	Not Supported
Time Delay to Low Power	Not Supported
Time-out Between Different Symbols	Not Supported
Time-out Between Same Symbol	Not Supported
<a href="#">Transmit "No Read / Decode" Message</a> (page 3-24)	Disable
<a href="#">Trigger Mode</a> (page 3-25)	Host
<b>UPC/EAN</b>	
<a href="#">UPC-A</a> (page 3-52)	Enable
<a href="#">UPC-E</a> (page 3-52)	Enable
<a href="#">UPC-E1</a> (page 3-53)	Disable
<a href="#">EAN-8</a> (page 3-53)	Enable
<a href="#">EAN-13</a> (page 3-54)	Enable
<a href="#">Bookland EAN</a> (page 3-54)	Disable
<a href="#">Bookland ISBN Format</a> (page 3-55)	Bookland ISBN-10
<a href="#">Decode UPC/EAN Supplementals</a> (page 3-62)	Ignore
<a href="#">Decode UPC/EAN Supplemental Redundancy</a> (page 3-64)	7
<a href="#">Transmit UPC-A Check Digit</a> (page 3-55)	Enable
<a href="#">Transmit UPC-E Check Digit</a> (page 3-56)	Enable
<a href="#">Transmit UPC-E1 Check Digit</a> (page 3-56)	Enable
<a href="#">UPC-A Preamble</a> (page 3-59)	System Character
<a href="#">UPC-E Preamble</a> (page 3-60)	System Character
<a href="#">UPC-E1 Preamble</a> (page 3-61)	System Character
<a href="#">Convert UPC-E to UPC-A</a> (page 3-57)	Disable
<a href="#">Convert UPC-E1 to UPC-A</a> (page 3-57)	Disable
<a href="#">Convert EAN-8 to EAN-13 Type</a> (page 3-58)	Type is EAN-13
<a href="#">EAN-8 Zero Extend</a> (page 3-65)	Disable
<a href="#">UPC/EAN Security Level</a> (page 3-66)	0
<a href="#">UCC Coupon Extended Code</a> (page 3-65)	Disable
Linear UPC/EAN Decode	Not Supported
UPC Half Block Stitching	Not Supported
UPC Composite Mode	Not Supported
<b>Code 128</b>	
<a href="#">Code 128</a> (page 3-33)	Enable
<a href="#">GS1-128 (formerly UCC/EAN-128)</a> (page 3-33)	Enable
<a href="#">ISBT-128</a> (page 3-34)	Enable
Code 128 Decode Performance	Not Supported
Code 128 Decode Performance Level	Not Supported
<b>Code 39</b>	
<a href="#">Code 39</a> (page 3-35)	Enable
<a href="#">Trioptic Code 39</a> (page 3-39)	Disable
<a href="#">Convert Code 39 to Code 32</a> (page 3-36)	Disable
<a href="#">Code 32 Prefix</a> (page 3-36)	Disable
<a href="#">Set Lengths for Code 39</a> (page 3-37)	Length within Range: 02 – 55

<b>Ring Scanner Setting 955</b>	<b>Default</b>
<a href="#">Code 39 Check Digit Verification</a> (page 3-35)	Disable
<a href="#">Transmit Code 39 Check Digit</a> (page 3-39)	Disable
<a href="#">Code 39 Full ASCII Conversion</a> (page 3-37)	Disable
Code 39 Decode Performance	Not Supported
Code 39 Decode Performance Level	Not Supported
<b>Code 93</b>	
<a href="#">Code 93</a> (page 3-40)	Disable
<a href="#">Set Lengths for Code 93</a> (page 3-40)	Length within Range: 04 – 55
<b>Code 11</b>	
<a href="#">Code 11</a> (page 3-30)	Disable
<a href="#">Set Lengths for Code 11</a> (page 3-30)	Length within Range: 04 – 55
<a href="#">Code 11 Check Digit Verification</a> (page 3-32)	Disable
<a href="#">Transmit Code 11 Check Digits</a> (page 3-32)	Disable
<b>Interleaved 2 of 5</b>	
<a href="#">Interleaved 2 of 5</a> (page 3-44)	Enable
<a href="#">Set Lengths for I 2 of 5</a> (page 3-45)	14
<a href="#">I 2 of 5 Check Digit Verification</a> (page 3-44)	Disable
<a href="#">Transmit I 2 of 5 Check Digit</a> (page 3-47)	Disable
<a href="#">Convert I 2 of 5 to EAN-13</a> (page 3-45)	Disable
<b>Discrete 2 of 5</b>	
<a href="#">Discrete 2 of 5</a> (page 3-42)	Disable
<a href="#">Set Lengths for Discrete 2 of 5</a> (page 3-42)	12
<b>Chinese 2 of 5</b>	
<a href="#">Chinese 2 of 5</a> (page 3-26)	Disable
<a href="#">Codabar</a> (page 3-27)	
<a href="#">CLSI Editing</a> (page 3-27)	Disable
<a href="#">NOTIS Editing</a> (page 3-28)	Disable
<a href="#">Set Lengths for Codabar</a> (page 3-28)	Length within Range: 05-55
<b>MSI Plessey</b>	
<a href="#">MSI Plessey</a> (page 3-48)	Disable
<a href="#">Set Lengths for MSI Plessey</a> (page 3-49)	Length within Range: 06-55
<a href="#">MSI Plessey Check Digits</a> (page 3-49)	One
<a href="#">Transmit MSI Plessey Check Digit</a> (page 3-51)	Disable
<a href="#">MSI Plessey Check Digit Algorithm</a> (page 3-48)	Mod 10/Mod 10
<b>PDF417/MicroPDF417</b>	
PDF417	Not Supported
MicroPDF417	Not Supported
Decode Linked Symbol	Not Supported
Code 128 Emulation	Not Supported
<b>GS1 DataBar (RSS) Codes</b>	
<a href="#">GS1 DataBar Omnidirectional (RSS-14)</a> (page 3-67)	Disable
<a href="#">GS1 DataBar Limited (RSS-Limited)</a> (page 3-67)	Disable
<a href="#">Convert GS1 DataBar (RSS) to UPC/EAN</a> (page 3-68)	Disable

<b>Ring Scanner Setting 955</b>	<b>Default</b>
Convert GS1 DataBar (RSS) to UPC/EAN	Disable
<b>Composite</b>	
CC-C	Not Supported
CC-AB	Not Supported
TLC-39	Not Supported
<b>Data Options</b>	
<a href="#">Prefix and Suffix</a> (page 3-8)	Prefix: NULL, Suffix 1: LF, Suffix 2:CR
<a href="#">Scan Data Transmission Format</a> (page 3-9)	Data as is
<a href="#">Transmit Code ID Character</a> (page 3-11)	None
Decode Buffering	Not Supported
<b>Simple Serial Interface (SSI) Options</b>	
<a href="#">Baud Rate</a> (page 3-18)	9600
<a href="#">Parity</a> (page 3-20)	None
Check Parity	Not Supported
<a href="#">Software Handshaking</a> (page 3-22)	Enable
<a href="#">Decode Data Packet Format</a> (page 3-19)	Unpacketed
<a href="#">Stop Bit Select</a> (page 3-23)	1
<a href="#">Intercharacter Delay</a> (page 3-20)	0
<a href="#">Host Serial Response Time-out</a> (page 3-19)	2 sec
<a href="#">Host Character Time-out</a> (page 3-19)	200 msec
<b>Macro PDF</b>	
Macro PDF Transmit/Decode Mode	Not Supported
Transmit Each Symbol in Codeword Format	Not Supported
Transmit Unknown Codewords	Not Supported
Escape Character	Not Supported
<b>ECI</b>	
Delete Character Set ECIs	Not Supported
ECI Decoder	Not Supported
<b>Transmit Macro PDF User-Selected Field</b>	
Transmit File Name	Not Supported
Transmit Block Count	Not Supported
Transmit Time Stamp	Not Supported
Transmit Sender	Not Supported
Transmit Addressee	Not Supported
Transmit Checksum	Not Supported
Transmit File Size	Not Supported
Transmit Macro PDF Control Header	Not Supported
Last Block Marker	Not Supported
Flush Macro Buffer	Not Supported
Abort Macro PDF Entry	Not Supported

---

## ***Set Default Parameter***

### *Restore Defaults*

If custom defaults were set by scanning Write Custom Defaults, scan Restore Defaults to retrieve and restore the scanner's custom default settings. If no custom defaults were set, scan Restore Defaults to restore the factory default values.

### *Set Factory Defaults*

Restore the factory default values. If custom defaults were set, they are eliminated.

### *Write Custom Defaults*

Store the current scanner settings as custom defaults. Once custom default settings are stored, they can be recovered at any time by scanning the Restore Defaults bar code.

Restore Defaults



Set Factory Defaults

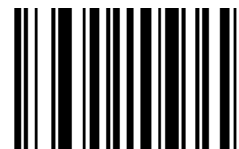

Write Custom Defaults



See Also: [Return to Factory Default Settings](#) (page 2-9).

---

## Scanner Parameters – General

### **Aim Duration**

*Note: For correct operation, reboot the mobile device after changing this value.*

When a scanner with an aim mode is triggered either by a Scan button press, or a Start\_Decode command, this parameter sets the duration the aiming pattern is seen before a scan attempt begins. It does not apply to the aim signal or the Aim\_On command. It is programmable in 0.1 second increments from 0.0 to 9.9 seconds. No aim pattern is visible when the value is 0.0.

To set aim duration, scan the bar code below:

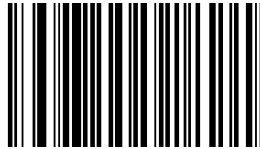

Next scan two numeric bar codes that correspond to the desired aim duration. Times less than 1.0 second must have a leading zero. For example, to set an aim duration of 0.5 seconds, scan the bar code above, then scan the “0” and “5” bar codes on [Keypad Number Symbols](#) (page 3-72). If you make an error, or wish to change your selection, scan the Cancel bar code.

### **Bi-Directional Redundancy**

Use this parameter to decide whether a bar code is successfully scanned in both directions before being decoded.

*Note: This parameter is only valid when a [Linear Code Type Security Level \(Redundancy Level\)](#) (page 3-15) has been enabled. The default for Security Level parameter is Level 1.*

Select an option by scanning either of the bar codes shown below.

Enable Bi-Directional Redundancy

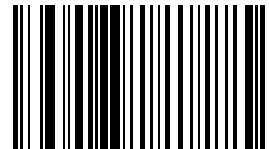

\* Disable Bi-Directional Redundancy

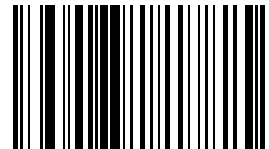

---

## Disable All Symbologies

Scan the bar code below to disable the decoding of all symbologies. Use this to simplify selecting a single symbology to decode by scanning this bar code, then scanning the desired enable code type bar code.

Note that the decoder can still decode parameter bar codes.



## Data Options

Note: SE955 ring scanner engine prefix and suffix parameters cannot be set, changed, or reset using the bar codes in this chapter. See previous section titled [Prefix / Suffix](#) (page 3-2).

### Prefix and Suffix

Ring decoder engine prefix and suffix parameters should not be set, changed, or reset using the Prefix and Suffix bar codes shown in this section. When the Ring Scanner Module is reset to defaults, the prefix and suffix settings revert to their default values and need to be scanned again. Use the ScanWedge NGW Power Tool (Dolphin 70e) or Scanner control panel (HX2 or HX3) in the host computer to store prefix and suffix values.

Setting	Default
Prefix (P)	Null
Suffix1 (S1)	LF
Suffix2 (S2)	CR

[Scan Data Transmission Format](#) (page 3-9) must be set before selecting Prefix/Suffix values.

A prefix and/or one or two suffixes may be appended to scan data for use in data editing. These values are set by scanning four bar codes (resulting in a four digit number) that correspond to key codes for various mobile devices. See the table titled "ASCII Character Equivalents".

If you wish to change your selection, scan this Data Format Cancel bar code:



### Prefix

To begin setting Prefix values, scan this bar code:

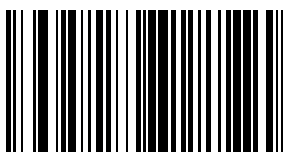

Next, scan four numeric bar codes that correspond to the computer keycode using the [Keypad Number Symbols](#) (page 3-72).

If you wish to change your selection, scan Cancel on the Keypad Number Symbols page.

### Suffix 1

To begin setting Suffix 1 value, scan this bar code:



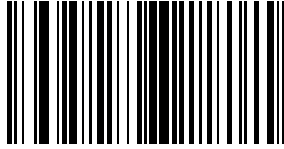

Next, scan four numeric bar codes that correspond to the computer keycode using the [Keypad Number Symbols](#) (page 3-72).

If you wish to change your selection, scan Cancel on the Keypad Number Symbols page.

### **Suffix 2**

To begin setting Suffix 2 value, scan this bar code:

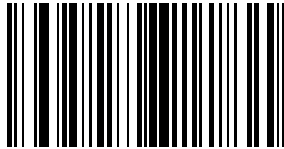

Next, scan four numeric bar codes that correspond to the computer keycode using the [Keypad Number Symbols](#) (page 3-72).

If you wish to change your numeric selection, scan Cancel on the Keypad Number Symbols page.

### **Scan Data Transmission Format**

*Note: Parameter [Prefix and Suffix](#) (page 3-8) should be set after setting this parameter.*

Use this option when you want to append a prefix and suffix to the decode data.

Set this parameter by scanning one of the following bar codes.

\* Data As Is

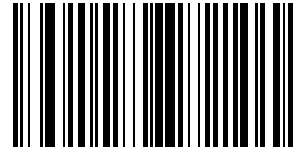

[Data] [Suffix 1]

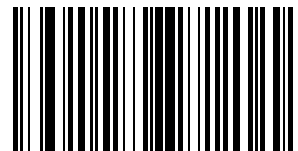

[Data] [Suffix 2]

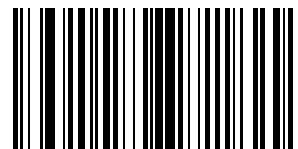

---

[Data] [Suffix 1] [Suffix 2]

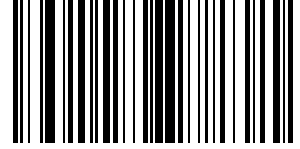

[Prefix] [Data]

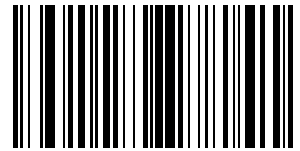

[Prefix] [Data] [Suffix 1]

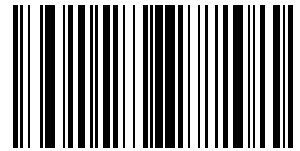

[Prefix] [Data] [Suffix 2]

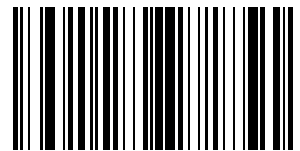

[Prefix] [Data] [Suffix 1] [Suffix 2]

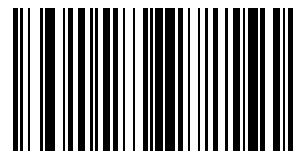

---

## ***Transmit Code ID Character***

Default Value: None

A code ID character identifies the code type of a scanned bar code. This may be useful when the scanner is decoding more than one code type. In addition to any single character prefix already selected, the code ID character is inserted between the prefix and the decoded symbol.

Scan one of the following bar codes to select either no code ID character, a Symbol Code ID character or an AIM Code ID character.

### ***Transmit No Code ID Character***

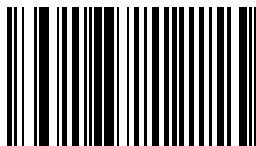

### ***Transmit Symbol Code ID Character***

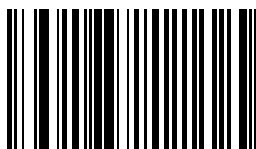

A	UPC-A, UPC-E, UPC-E1, EAN-8, EAN-13
B	Code 39, Code 32
C	Codabar
D	Code 128, ISBT 128
E	Code 93
F	Interleaved 2 of 5
G	Discrete 2 of 5 or Discrete 2 of 5 IATA
H	Code 11
J	MSI Plessey
K	UCC/EAN-128
L	Bookland EAN
M	Trioptic Code 39
N	Coupon Code
R	GS1 DataBar Omnidirectional (RSS-14), GS1 Limited (RSS-Limited), GS1 Expanded (RSS-Expanded)

## Transmit AIM Code ID Character

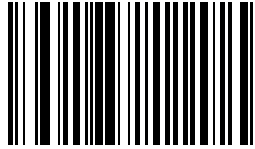

Each AIM Code Identifier contains the three character string ]cm where:

] = Flag Character (ASCII 93)

c = Code Character

A	Code 39
C	Code 128
E	UPC/EAN
F	Codabar
G	Code 93
H	Code 11
I	Interleaved 2 of 5
M	MSI Plessey
S	D2 of 5, IATA 2 of 5
X	Code 39 Trioptic, Bookland EAN
e	GS1 DataBar (RSS)

m = Modifier Character

The modifier character is the sum of the applicable option values based on the following table.

Code Type	Option Value	Option
<b>Code 39</b>		
	0	No Check character or Full ASCII processing.
	1	Reader has checked one check character.
	3	Reader has checked and stripped check character.
	4	Reader has performed Full ASCII character conversion.
	5	Reader has performed Full ASCII character conversion and checked one check character.
	7	Reader has performed Full ASCII character conversion and checked and stripped check character.
		Example: A Full ASCII bar code with check character W,A+I+MI+DW, is transmitted as ]A7Aimld where 7 = (3+4).
<b>Trioptic Code 39</b>		
	0	No option specified at this time. Always transmit 0.
		Example: A Trioptic bar code 412356 is transmitted as ]X0412356
<b>Code 128</b>		
	0	Standard data packet, No Function code 1 in first symbol position.
	1	Function code 1 in first symbol character position.
	2	Function code 1 in second symbol character position.
		Example: A Code (EAN) 128 bar code with Function 1 character in the first position, <sup>FNC1</sup> Aim Id is transmitted as ]CIAimld

Code Type	Option Value	Option
<b>Interleaved 2 of 5</b>		
	0	No check digit processing.
	1	Reader has validated check digit.
	3	Reader has validated and stripped check digit .
		Example: An I 2 of 5 bar code without check digit, 4123, is transmitted as ]I04123
<b>Codabar</b>		
	0	No check digit processing.
	1	Reader has checked check digit.
	3	Reader has stripped check digit before transmission.
		Example: A Codabar bar code without check digit, 4123, is transmitted as ]F04123
<b>Code 93</b>		
	0	No options specified at this time. Always transmit 0.
		Example: A Code 93 bar code 012345678905 is transmitted as ]G0012345678905
<b>MSI (Plessey)</b>		
	0	Single check digit checked.
	1	Two check digits checked.
	2	Single check digit verified and stripped before transmission.
	3	Two check digits verified and stripped before transmission.
		Example: An MSI Plessey bar code 4123, with a single check digit checked, is transmitted as ]M04123
<b>Discrete 2 of 5</b>		
	0	No options specified at this time. Always transmit 0.
		Example: A D 2 of 5 bar code 4123, is transmitted as ]S04123
<b>UPC/EAN</b>		
	0	Standard packet in full EAN country code format, which is 13 digits for UPC-A and UPC-E (not including supplemental data).
	1	Two digit supplement data only
	2	Five digit supplement data only
	4	EAN-8 data packet.
		Example: A UPC-A bar code 012345678905 is transmitted as ]E00012345678905
<b>Bookland EAN</b>		
	0	No options specified at this time. Always transmit 0.
		Example: A Bookland EAN bar code 123456789X is transmitted as ]X0123456789X

According to AIM standards, a UPC with supplemental bar code is transmitted in the following format:

]EO (UPC chars) (terminator) ]E2 (supplemental) (terminator)

Therefore, a UPC with two supplemental characters, 01234567890510, is transmitted to the host as a 21-character string, ]E00012345678905]E110.

---

## **Laser On Time**

*Note: For correct operation, reboot the Bluetooth Ring Scanner after changing this value.*

Default: 3.0 seconds

This parameter sets the maximum time decode processing continues during a scan attempt. It is programmable in 0.1 second increments from 0.50 to 25.5 seconds. If a label has not been decoded before this time expires and the session is terminated, the system regards it as a failed scan attempt.

To begin setting Laser On Time, scan this bar code:



Next, scan two numeric bar codes that correspond to the desired on time using the [Keypad Number Symbols](#) (page 3-72). Times less than 1.0 second must have a leading zero.

If you wish to change your number selection, scan Cancel on the Keypad Number Symbols page.

See Also: [Laser On Time \(superseded\)](#) (page 3-69)

---

## Linear Code Type Security Level (Redundancy Level)

Use this parameter to determine the security level appropriate for bar code quality. The security level indicates how many times the bar code must be successfully read by the scanner before being decoded.

There are four security levels. Higher security levels are selected for decreasing levels of bar code quality. As security levels increase, the scanner's aggressiveness decreases.

Select an option by scanning one of the bar codes shown below. If you wish to change your selection, scan Cancel.

Level 1	The following code types must be successfully read twice before being decoded: Codabar : All lengths MSI Plessey : Length of 4 characters or less D 2 of 5 : Length of 8 characters or less I 2 of 5 : Length of 8 characters or less
Level 2	All code types must be successfully read twice before being decoded.
Level 3	Code types other than the following must be successfully read two times before being decoded. The following codes must be read three times: MSI Plessey : Length of 4 characters or less D 2 of 5 : Length of 8 characters or less I 2 of 5 : Length of 8 characters or less
Level 4	All code types must be successfully read three times before being decoded.

*Note: Linear Code Type Security does not apply to Code 128.*

\* Level 1

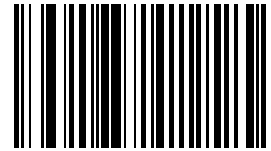

Level 2

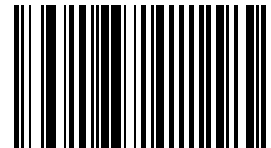

Level 3

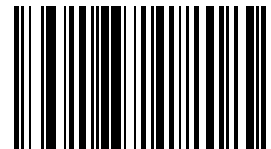

Level 4

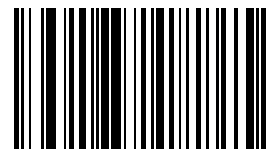

---

## Parameter Pass Through

Enable Parameter Pass Through to transmit bar codes in the following format, in Code 128, to the host:

<FNC3>L<any length data>

<FNC3>B<12 characters of data>

Note that the special Code 128 character <FNC3> must appear at the beginning of this data. However, if the appropriate data does not follow this as shown above, it does not transmit to the host device.

Enable Parameter Pass Through

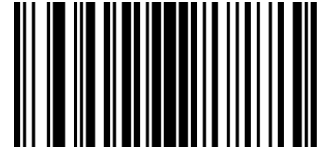

\* Disable Parameter Pass Through



## Parameter Scanning

Use this parameter to decide whether scanner parameters can be set using the bar codes in this section.

*Note: When this parameter is disabled, scan the [Set Default Parameter](#) (page 3-6) bar code to enable parameter scanning.*

When disabled, either scan the Enable Parameter Scanning bar code or the Set All Defaults bar code (or set this parameter to 01h via a serial command) to reset the parameter and bar codes in this section can then be scanned.

When enabled, scanners can be configured using the bar codes in this section.

Select a mode by scanning either of the bar codes shown below.

\* Enable Parameter Scanning

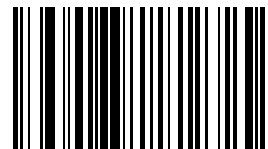

Disable Parameter Scanning

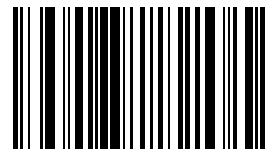



---

## **Power Mode**

*Note: Mobile devices are designed to be operated in Low Power Mode. For best results this value should remain unchanged.*

*Note: A parameter setting of Continuous On means the laser scanner will not power down until the mobile device is powered off.*

A parameter setting of Low Power means the laser scanner will enter low power mode after one second of waiting for a Scan button press. Pressing the Scan button will begin the decode sequence.

Select a Power Mode by scanning either of the bar codes shown below.

Continuous On

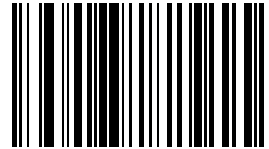

\* Low Power

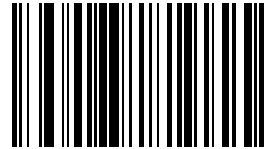

## **Scan Angle (SE955 only)**

Choose one of the options below to set the scan angle to narrow or wide. Once the parameter bar code is scanned, the Scan Angle setting is persistently stored.

Select an option by scanning one of the bar codes shown below.

Narrow Angle (35°)



\* Wide Angle



See Also: [Scan Angle \(SE955 only\) superseded](#) (page 3-69)

---

## Simple Serial Interface (SSI) Options

The SSI Options bar codes are directed toward the host programmer when writing host/scanner interface programs for different hosts. Contact [Customer Support](#) (page 7-1) for technical help.

*Note: Baud Rate Parameter must remain at 9600 bps at all times.*

### SSI Defaults

The SSI Options bar codes are directed toward the host programmer when writing host/scanner interface programs for different hosts.

Option	Default Value
Baud Rate	Not Supported
Beep on < BEL >	Supported
Check Parity	Not Supported
Decode Data Packet Format	Unpacketed
Host Character Time-out	200 msec
Host Serial Response Time out	2 sec
Intercharacter Delay	0
Parity	None
Software Handshaking	Enable
Stop Bit Select	1

### Beep on BEL

This parameter is enabled. There is no corresponding programming bar code required.

### Baud Rate

Baud rate is the number of bits of data transmitted per second. The scanners baud rate setting should match the data rate setting of the host device. If not, data may not reach the host device or may reach it in distorted form.

Baud rate should always be set to 9600. If the baud rate is set to any other value but 9600, a transmit error will occur. Either scan the 9600 bps bar code or reset the mobile device to factory default (or last saved good default) values.

Set this parameter by scanning this bar code.

9600 bps

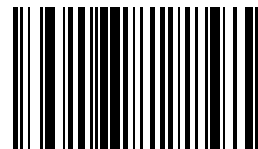

The SSI Options bar codes are directed toward the host programmer when writing host/scanner interface programs for different hosts. Contact [Customer Support](#) (page 7-1) for technical help.

---

### **Decode Data Packet Format**

This parameter selects whether decoded data is transmitted in raw format (unpacked), or transmitted with the packet format as defined by the serial protocol.

If the raw format is chosen, ACK/NAK handshaking is automatically disabled for decode data.

Set this parameter by scanning either of the following bar codes.

\* Send Raw Decode Data

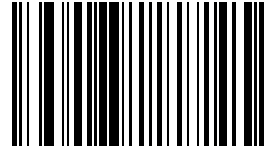

Send Packeted Decode Data

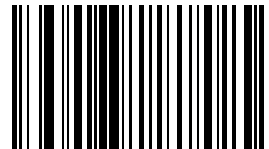

The SSI Options bar codes are directed toward the host programmer when writing host/scanner interface programs for different hosts. Contact [Customer Support](#) (page 7-1) for technical help.

### **Host Character Time-out**

Host Character Time-out Default: 200 msec

This parameter determines the maximum time the decoder waits between characters transmitted by the host before discarding the received data and declaring an error. The time-out is set in 0.01 second increments from 0.01 seconds to 0.99 seconds. After scanning the bar code below, scan two numerical bar codes to set the desired time-out.

To begin setting the time-out value, scan this bar code:

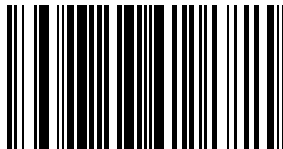

Next, scan two numeric bar codes that correspond to the desired value using the Keypad Number Symbols at the end of this chapter. Single digit numbers must have a leading zero. For example, a value of 300 msec is selected by scanning the “3” and the “0” numeric bar codes. A value of 30 msec is selected by scanning the “0” and the “3” bar codes.

If you wish to change your selection, scan Cancel on [Keypad Number Symbols](#) (page 3-72).

The SSI Options bar codes are directed toward the host programmer when writing host/scanner interface programs for different hosts.

Host Serial Response Time-out

Host Serial Response Time-out Default: 2 sec

This parameter determines the maximum time the decoder waits for an ACK or NAK before resending. Also, if the decoder wants to send, and the host has already been granted permission to send, the decoder waits for the designated time-out before declaring an error. The delay period can range from 0.0 to 9.9 seconds in 0.1 second increments. After scanning the bar code below, scan two numerical bar codes to set the delay.

To begin setting the time-out value, scan this bar code:

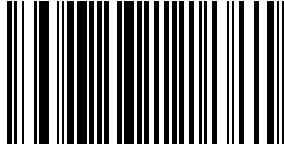

Next, scan two numeric bar codes that correspond to the desired value using the Keypad Number Symbols at the end of this chapter. Time durations of less than 1.0 second require a leading zero. For example, a value of 4.5 seconds is selected by scanning the “4” and the “5” numeric bar codes. A value of 0.3 seconds is selected by scanning the “0” and the “3” bar codes.

If you wish to change your selection, scan Cancel on the Keypad Number Symbols page.

The SSI Options bar codes are directed toward the host programmer when writing host/scanner interface programs for different hosts. Contact [Customer Support](#) (page 7-1) for technical help.

### **Intercharacter Delay**

Intercharacter Delay Default: 0 msec

Select the intercharacter delay option matching host requirements. The intercharacter delay gives the host system time to service its receiver and perform other tasks between characters.

The delay period can range from no delay to 99 msec in 1 msec increments. After scanning the bar code below, scan two numerical bar codes to set the delay.

To begin setting the delay value, scan this bar code:

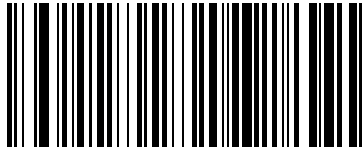

Next, scan two numeric bar codes that correspond to the desired value using the [Keypad Number Symbols](#) (page 3-72) at the end of this chapter. Time durations of less than 1 msec require a leading zero. For example, a value of 25 msec is selected by scanning the “2” and the “5” numeric bar codes. A value of 6 msec is selected by scanning the “0” and the “6” bar codes.

If you wish to change your selection, scan Cancel on [Keypad Number Symbols](#) (page 3-72).

The SSI Options bar codes are directed toward the host programmer when writing host/scanner interface programs for different hosts.

### **Parity**

A parity check bit is the most significant bit of each ASCII coded character. Select the parity type according to host device requirements.

Set this parameter by scanning one of the following bar codes.

#### **Odd Parity**

The Odd parity bit has a value 0 or 1, based on data, to ensure that an odd number of 1 bits is contained in the coded character.

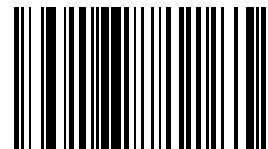

#### **Even Parity**

The Even parity bit has a value 0 or 1, based on data, to ensure that an even number of 1 bits is contained in the coded character.

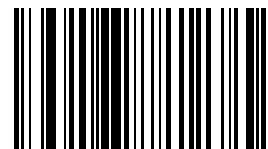

---

Mark Parity  
The parity bit is always 1.

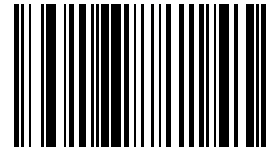

Space Parity  
The parity bit is always 0.

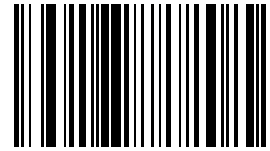

\* No Parity  
No parity is required.

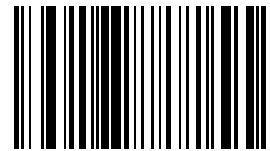

The SSI Options bar codes are directed toward the host programmer when writing host/scanner interface programs for different hosts. Contact [Customer Support](#) (page 7-1) for technical help.

---

## **Software Handshaking**

The SSI Options bar codes are directed toward the host programmer when writing host/scanner interface programs for different hosts. Contact [Customer Support](#) (page 7-1) for technical help.

This parameter offers control of the data transmission process in addition to that offered by hardware handshaking.

Hardware handshaking is always enabled and cannot be disabled by the user.

Scan one of the following bar codes to set software handshaking.

### **Disable ACK/NAK Handshaking**

When this option is selected, the decoder will neither generate nor expect ACK/NAK handshaking packets.

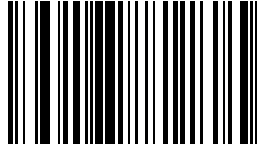

### **\* Enable ACK/NAK Handshaking**

When this option is selected, after transmitting data, the scanner expects either an ACK or NAK response from the host. The scanner will also ACK or NAK messages from the host when this option is selected.

The scanner waits up to the programmable Host Serial Response Time-out to receive an ACK or NAK. If the scanner does not get a response in this time, it resends its data up to two times before discarding the data and declaring a transmit error.

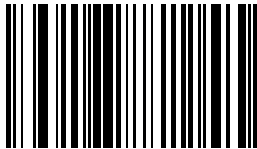

---

### **Stop Bit Select**

The stop bit(s) at the end of each transmitted character marks the end of transmission of one character and prepares the receiving device for the next character in the serial data stream.

The number of stop bits selected (one or two) depends on the number the receiving computer is programmed to accommodate. Set the number of stop bits to match host device requirements.

Set this parameter by scanning one of the following bar codes.

\* One Stop Bit

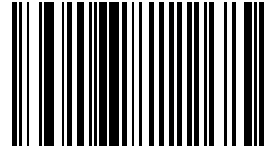

Two Stop Bits

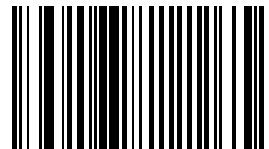

The SSI Options bar codes are directed toward the host programmer when writing host/scanner interface programs for different hosts. Contact [Customer Support](#) (page 7-1) for technical help.

### **Time-out Between Decodes, Same Symbol**

Default: 1.0 second

Use this parameter to prevent the beeper from continuously beeping when a symbol is left in the scanner's field of view.

To begin setting differing symbol timeout values, scan this bar code:

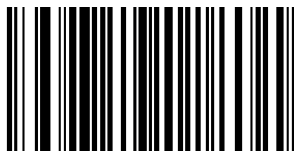

Using the [Keypad Number Symbols](#) (page 3-72) section at the end of this chapter, scan two numeric bar codes that represent the desired interval, in 0.1 second increments. Valid values are between 0.0 and 9.9 seconds. Single digit values must be predefined by a leading zero. For example, to set a timeout of 0.5 seconds, scan the Timeout/Decodes – Same bar code, then scan the number 0 and 5 bar codes.

If you wish to change your number selection, scan Cancel on the Keypad Number Symbols page.

---

### ***Transmit “No Read / Decode” Message***

Use this parameter to decide whether a message is sent to the host when a bar code symbol does not decode.

When enabled, and a symbol does not decode within either:

- A scan button press activates the laser and decode processing, the processing continues until a scan button release, or
- The laser decode processing continues until the Laser On Timeout is reached.
- A “NR” (No Read) is transmitted to the host. Any prefix or suffixes which have been enabled are appended around this message.

When disabled, and a symbol does not decode, no message is sent to the host.

Select an option by scanning either of the bar codes shown below.

Enable No Read

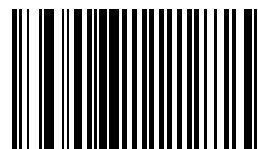

\* Disable No Read

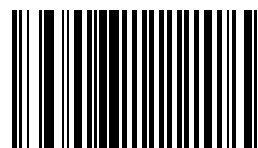



---

## Trigger Mode

*Note: The Bluetooth Ring Scanner Module with a ring scanner is designed to be operated in Host Trigger Mode. For best results leave the Trigger Mode default value unchanged for these devices.*

Use this parameter to determine when the laser is activated and decoding begins, how long the laser remains on and what determines the cessation of the laser scan and decode process.

Trigger Mode	Function
Level	A trigger pull or Scan button press activates the laser and decode processing. The laser remains on and decode processing continues until a trigger release, a valid decode or the Laser On Time-out is reached.
Pulse	A trigger pull or Scan button press activates the laser and decode processing. The laser remains on and decode processing continues until a valid decode, or the Laser On Time-out is reached.
Continuous	The laser is always on and decoding. See Also: <a href="#">Time-out Between Decodes, Same Symbol</a> (page 3-23)
Blinking	This trigger mode is used for triggerless scanning operations. Scanning range is reduced in this mode. This mode cannot be used with scanners that support an aim mode.
Host (default)	Triggering signal comes from a host command. Any actual trigger pull or Scan button press will be interpreted by the scanner engine as a Level triggering option.

Select a trigger mode by scanning the appropriate bar code. If you wish to change your selection, scan Cancel.

Level

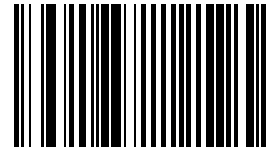

Pulse

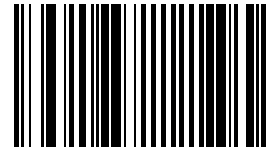

Continuous

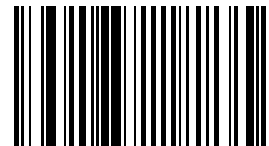

---

Blinking

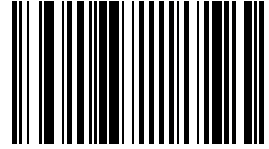

\* Host

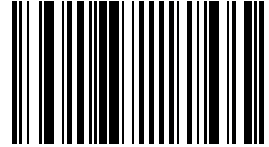

Cancel

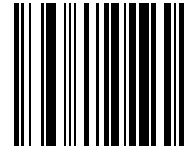

### ***Scanner Parameters – Bar Code Type Specific***

#### ***Chinese 2 of 5***

When enabled, Chinese 2 of 5 symbols will be scanned, decoded and transmitted. Set this parameter by scanning either of the bar codes shown below.

Enable Chinese 2 of 5

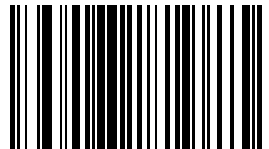

\* Disable Chinese 2 of 5

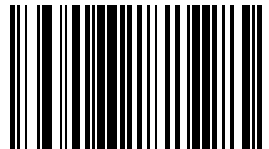

---

## **Codabar**

When enabled, Codabar symbols will be scanned, decoded and transmitted. Set this parameter by scanning either of the bar codes shown below.

Enable Codabar

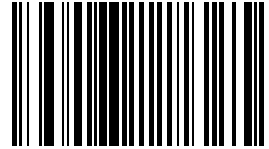

\* Disable Codabar

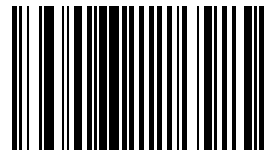

## **CLSI Editing**

When enabled, the start and stop characters are stripped from the bar code and a space is inserted after the 1<sup>st</sup>, 5<sup>th</sup>, and 10<sup>th</sup> characters of a 14 character Codabar symbol.

Set this parameter by scanning either of the bar codes shown below.

*Note: Symbol length does not include start and stop characters.*

Enable CLSI Editing

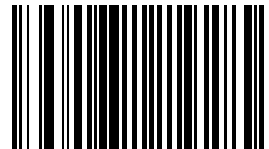

\* Disable CLSI Editing

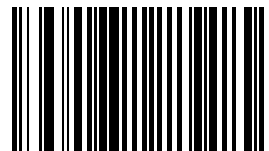

---

## **NOTIS Editing**

When enabled, the start and stop characters are stripped from a decoded Codabar symbol. Set this parameter by scanning either of the bar codes shown below.

Enable NOTIS Editing

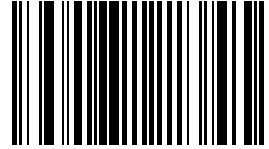

\* Disable NOTIS Editing

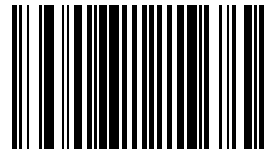

## **Set Lengths for Codabar**

L1 Default: 5

L2 Default: 55

Lengths for Codabar may be set for:

- any length,
- one or two discrete lengths,
- or lengths within a specific range.

The length of a code refers to the number of characters, including check digits, the code contains. It also includes any start or stop characters.

See the table titled [ASCII Character Equivalents](#) (page 6-1)

### **One Discrete Length (Parameter L1)**

This option decodes only those codes containing a selected length. For example, when you want to scan only Codabar symbols containing 14 characters, scan the “Codabar One Discrete Length” bar code and then “1” and “4” bar codes using the [Keypad Number Symbols](#) (page 3-72).

To begin setting one discrete length, scan this bar code:

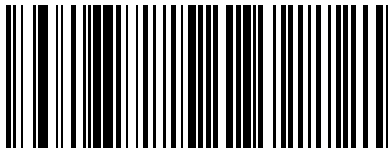

Next, scan two numeric bar codes that correspond to the desired value. Single digit numbers must have a leading zero. If you wish to change your number selection, scan Cancel on [Keypad Number Symbols](#) (page 3-72).

---

### ***Two Discrete Lengths (Parameter L2)***

This option decodes only those codes containing two selected lengths. For example, when you want to scan only Codabar symbols containing 2 or 14 characters, scan the “Codabar Two Discrete Lengths” bar code and then “0”, “2”, “1” and “4” bar codes using the [Keypad Number Symbols](#) (page 3-72) at the end of this chapter.

To begin setting two discrete lengths, scan this bar code:

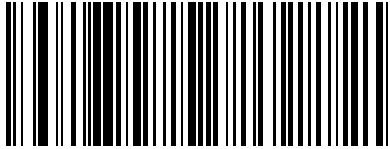

Next, scan four numeric bar codes that correspond to the desired value. Single digit numbers must have a leading zero. If you wish to change your number selection, scan Cancel on the Keypad Number Symbols page.

### ***Length Within Range***

This option decodes a code type within a specified minimum and maximum range. For example, when you want to scan only Codabar symbols containing between 4 and 12 characters, scan the “Codabar Length Within Range” bar code and then “0”, “4”, “1” and “2” bar codes.

To begin setting lengths within a range, scan this bar code:

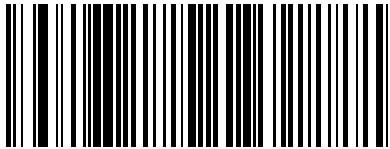

Next, scan numeric bar codes that correspond to the desired value using the [Keypad Number Symbols](#) (page 3-72). Single digit numbers must have a leading zero. If you wish to change your number selection, scan Cancel on the Keypad Number Symbols page.

### ***Any Length***

This option decodes Codabar bar codes containing any number of characters.

To set any length, scan this bar code:

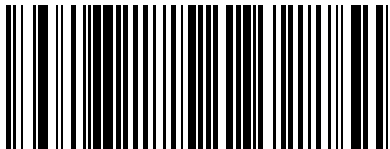

---

## Code 11

When enabled, Code 11 symbols will be scanned, decoded and transmitted. Set this parameter by scanning either of the bar codes shown below.

Enable Code 11

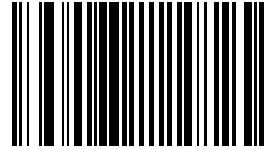

\* Disable Code 11

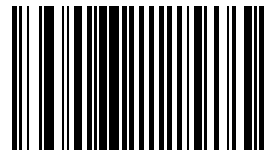

### **Set Lengths for Code 11**

L1 Default: 4

L2 Default: 55

Lengths for Code 11 may be set for:

- any length,
- one or two discrete lengths,
- or lengths within a specific range.

The length of a code refers to the number of characters, including check digits, the code contains. It also includes any start or stop characters.

See the table titled [ASCII Character Equivalents](#) (page 6-1).

#### **One Discrete Length (Parameter L1)**

This option decodes only those codes containing a selected length. For example, when you want to scan only Code 11 symbols containing 14 characters, scan the “Code 11 One Discrete Length” bar code and then “1” and “4” bar codes using the [Keypad Number Symbols](#) (page 3-72).

To begin setting one discrete length, scan this bar code:

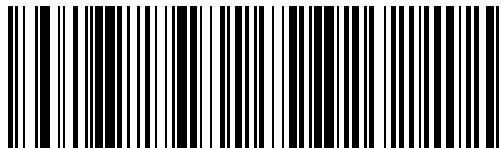

Next, scan two numeric bar codes that correspond to the desired value. Single digit numbers must have a leading zero. If you wish to change your number selection, scan Cancel on the Keypad Number Symbols page.

#### **Two Discrete Lengths (Parameter L2)**

This option decodes only those codes containing two selected lengths. For example, when you want to scan only Code 11 symbols containing 2 or 14 characters, scan the “Code 11 Two Discrete Lengths” bar code and then “0”, “2”, “1” and “4” bar codes using the Keypad Number Symbols at the end of this chapter.

To begin setting two discrete lengths, scan this bar code:

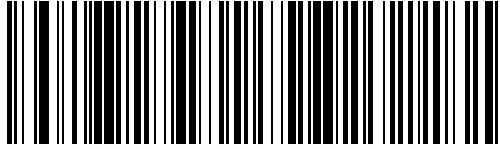

Next, scan four numeric bar codes that correspond to the desired value. Single digit numbers must have a leading zero. If you wish to change your number selection, scan Cancel on the Keypad Number Symbols page.

***Length Within Range***

This option decodes a code type within a specified minimum and maximum range. For example, when you want to scan only Code 11 symbols containing between 4 and 12 characters, scan the “Code 11 Length Within Range” bar code and then “0”, “4”, “1” and “2” bar codes.

To begin setting lengths within a range, scan this bar code:

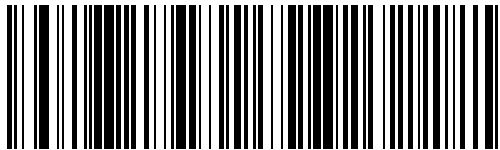

Next, scan numeric bar codes that correspond to the desired value using the [Keypad Number Symbols](#) (page 3-72). Single digit numbers must have a leading zero. If you wish to change your number selection, scan Cancel on the Keypad Number Symbols page.

***Any Length***

This option decodes Code 11 bar codes containing any number of characters.

To set any length, scan this bar code:

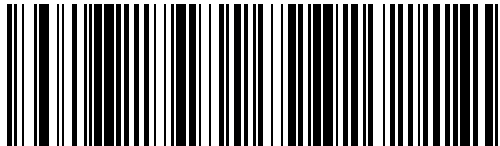

---

### **Code 11 Check Digit Verification**

When enabled, this parameter checks the integrity of a Code 11 symbol to ensure it complies with the specified check digit algorithm.

*Note: Enable "Code 11 Check Digit Verification" when "Transmit Code 11 Check Digits" is enabled.*

Set this parameter by scanning one of the bar codes shown below.

\* Disable this feature



One Check Digit

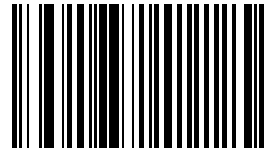

Two Check Digits

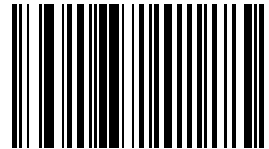

### **Transmit Code 11 Check Digits**

*Note: Code 11 Check Digit Verification must be enabled for this parameter to function.*

Transmit (Enable)

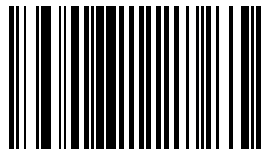

\* Do Not Transmit (Disable)

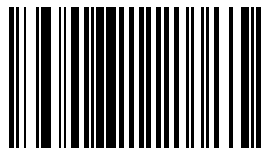



---

## **Code 128**

Set this parameter by scanning either of the bar codes shown below.

\* Enable Code 128

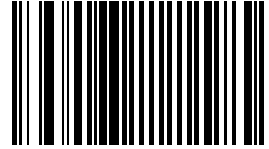

Disable Code 128

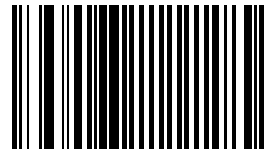

## **GS1-128 (formerly UCC/EAN-128)**

Set this parameter by scanning either of the bar codes shown below.

\* Enable GS1-128

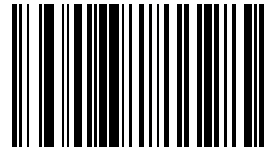

Disable GS1-128

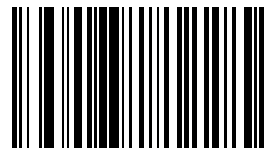

GS1-128 is a convention for printing data fields with standard Code 128 bar code symbols. GS1-128 symbols are distinguished by a leading FNC 1 character as the first or second character in the symbol. Other FNC 1 characters are used to delineate fields.

When GS1-128 symbols are read, they are transmitted after special formatting strips off the leading FNC 1 character, and replaces other FNC 1 characters with the ASCII 29 (GS) control character.

When AIM symbology identifiers are transmitted, the modifier character indicates the position of the leading FNC 1 character according to AIM guidelines. For example, jc1 indicates a GS1-128 symbol with a leading FNC1 character.

Standard Code 128 bar codes which do not have a leading FNC 1 may still be used, but are not encoded according to the GS1-128 convention. Standard Code 128 and GS1-128 may be mixed in an application. The SE955 autodiscriminates between these symbols, and can enable or disable one or both code types.

The following table indicates the behavior of the SE955 in each of the four possible parameter settings.

Standard Code 128	UCC/EAN 128	Effect and Example
Disable	Disable	No Code 128 symbols can be read.
Disable	Enable	Read only symbols with leading FNC1.
		Examples:
		FNC1ABCD <sup>FNC1</sup> E are read as ABCD <sup>29</sup> E
		A <sup>FNC1</sup> BCD <sup>FNC1</sup> E are read as ABCD <sup>29</sup> E
		FNC1FNC1ABCD <sup>FNC1</sup> E are read as ABCD <sup>29</sup> E
		ABCD <sup>FNC1</sup> E cannot be read
		ABCDE cannot be read
Enable	Disable	Read only symbols without leading FNC1.
		Examples:
		FNC1ABCD <sup>FNC1</sup> E cannot be read
		A <sup>FNC1</sup> BCD <sup>FNC1</sup> E cannot be read
		FNC1FNC1ABCD <sup>FNC1</sup> E cannot be read
		ABCD <sup>FNC1</sup> E is read as ABCD <sup>29</sup> E
		ABCDE is read as ABCDE
Enable	Enable	Read both types of symbols.
		Examples:
		FNC1ABCD <sup>FNC1</sup> E are read as ABCD <sup>29</sup> E
		A <sup>FNC1</sup> BCD <sup>FNC1</sup> E are read as ABCD <sup>29</sup> E
		FNC1FNC1ABCD <sup>FNC1</sup> E are read as ABCD <sup>29</sup> E
		ABCD <sup>FNC1</sup> E is read as ABCD <sup>29</sup> E
		ABCDE is read as ABCDE

### ISBT-128

Set this parameter by scanning either of the bar codes shown below.

\* Enable ISBT-128

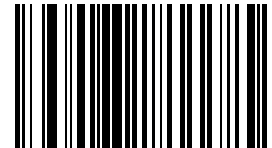

Disable ISBT-128

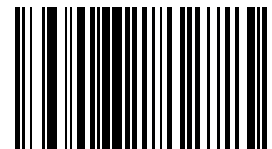

### Lengths for Code 128

No length setting is required for Code 128. The default setting is Any Length.

---

## **Code 39**

*Note: This parameter must be enabled when "Convert Code 39 to Code 32" is to be enabled.*

Set this parameter by scanning either of the bar codes shown below.

\* Enable Code 39

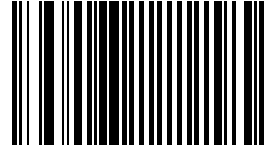

Disable Code 39

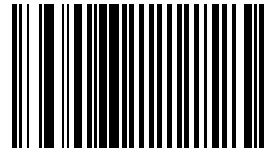

## **Code 39 Check Digit Verification**

When enabled, this parameter checks the integrity of a Code 39 symbol to ensure it complies with specified algorithms. Only those Code 39 symbols which include a modulo 43 check digit are decoded when this parameter is enabled.

Set this parameter by scanning either of the bar codes shown below.

Enable Code 39 Check Digit Verification

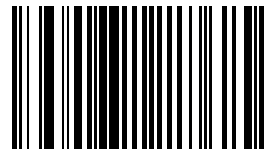

\* Disable Code 39 Check Digit Verification

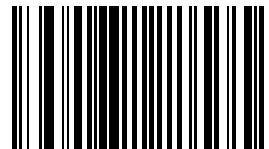

---

### **Code 32 Prefix**

This parameter adds the prefix character “A” to all Code 32 bar codes.

*Note: When enabled, “Convert Code 39 to Code 32” parameter must also be enabled.*

Set this parameter by scanning either of the bar codes shown below.

Enable Code 32 Prefix

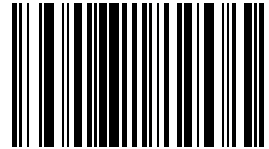

\* Disable Code 32 Prefix

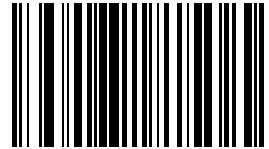

### **Convert Code 39 to Code 32**

*Note: Code 39 must be enabled in order for this parameter to function.*

*Note: When parameter “Code 32 Prefix” is to be enabled, this Convert Code 39 to Code 32 (Italian Pharma Code) parameter must also be enabled.*

Set this parameter by scanning either of the bar codes shown below.

Enable Convert Code 39 to Code 32

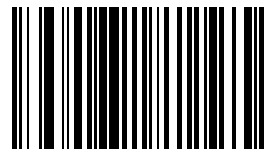

\* Disable Convert Code 39 to Code 32

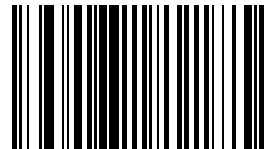

---

## Code 39 Full ASCII Conversion

*Note: Code 39 Full ASCII and Trioptic Code 39 should not be enabled simultaneously.*

When enabled, the ASCII character set assigns a code to letter, punctuation marks, numerals, and most control key-strokes on the keyboard.

The first 32 codes are non-printable and are assigned to keyboard control characters such as [Backspace] and [Return or Enter]. The other 96 are called printable codes because all but [Space] and [Delete] produce visible characters.

Code 39 Full ASCII interprets the bar code special character (\$ + % /) preceding a Code 39 character and assigns an ASCII character value to the pair.

See the table titled [ASCII Character Equivalents](#) (page 6-1).

Set this parameter by scanning either of the bar codes shown below.

Enable Code 39 Full ASCII Conversion

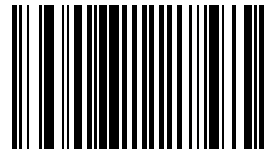

\* Disable Code 39 Full ASCII Conversion

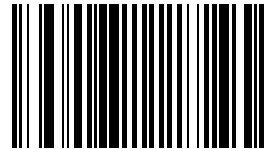

## Set Lengths for Code 39

L1 Default: 2

L2 Default: 55

Lengths for Code 39 may be set for:

- any length,
- one or two discrete lengths,
- or lengths within a specific range.

The length of a code refers to the number of characters, including check digits, the code contains. If “Code 39 Full ASCII” is enabled, “Length Within a Range” or “Any Length” are the preferred options.

See the table titled [ASCII Character Equivalents](#) (page 6-1).

### **Code 39 One Discrete Length (Parameter L1)**

This option decodes only those codes containing a selected length. For example, when you want to scan only Code 39 symbols containing 14 characters, scan the “Code 39 One Discrete Length” bar code and then “1” and “4” bar codes using the [Keypad Number Symbols](#) (page 3-72) at the end of this chapter.

To begin setting one discrete length, scan this bar code:

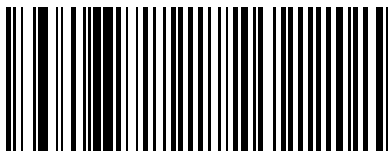

Next, scan two numeric bar codes that correspond to the desired value. Single digit numbers must have a leading zero. If you wish to change your number selection, scan Cancel on the Keypad Number Symbols page.

---

### **Code 39 Two Discrete Lengths (Parameter L2)**

This option decodes only those codes containing two selected lengths. For example, when you want to scan only Code 39 symbols containing 2 or 14 characters, scan the “Code 39 Two Discrete Lengths” bar code and then “0”, “2”, “1” and “4” bar codes using the [Keypad Number Symbols](#) (page 3-72) at the end of this chapter.

To begin setting two discrete lengths, scan this bar code:

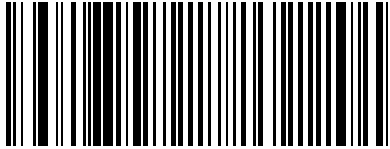

Next, scan four numeric bar codes that correspond to the desired value. Single digit numbers must have a leading zero. If you wish to change your number selection, scan Cancel on the Keypad Number Symbols page.

### **Code 39 Length Within Range**

This option decodes a code type within a specified minimum and maximum range. For example, when you want to scan only Code 39 symbols containing between 4 and 12 characters, scan the “Code 39 Length Within Range” bar code and then “0”, “4”, “1” and “2” bar codes using the [Keypad Number Symbols](#) (page 3-72).

To begin setting lengths within a range, scan this bar code:

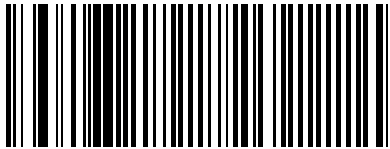

Next, scan numeric bar codes that correspond to the desired value. Single digit numbers must have a leading zero. If you wish to change your number selection, scan Cancel on the Keypad Number Symbols page.

### **Code 39 Any Length**

This option decodes Code 39 bar codes containing any number of characters.

To set any length, scan this bar code:

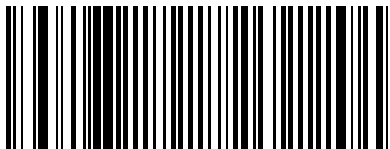

---

### ***Transmit Code 39 Check Digit***

When enabled, the check digit is transmitted with the data.

Parameter setting for “Code 39 Check Digit Verification” has no effect on this parameter value.

Set this parameter by scanning either of the bar codes shown below.

Enable Transmit Code 39 Check Digit

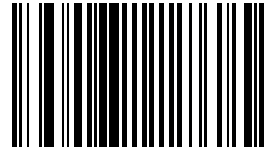

\* Disable Transmit

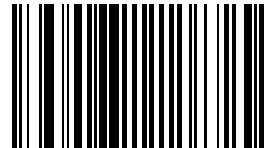

### ***Trioptic Code 39***

Trioptic Code 39 symbols always contain six characters.

When Trioptic Code 39 is enabled, set the “Code 39 Full ASCII” parameter to disabled. Both parameters should not be enabled simultaneously.

Set this parameter by scanning either of the bar codes shown below.

Enable Trioptic Code 39

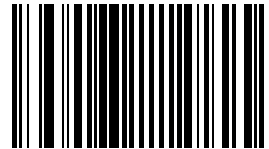

\* Disable Trioptic Code 39

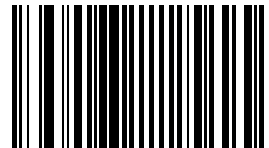

---

## Code 93

When enabled, Code 93 symbols will be scanned, decoded and transmitted. Set this parameter by scanning either of the bar codes shown below.

Enable Code 93

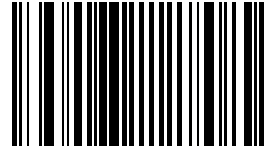

\* Disable Code 93

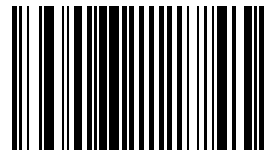

### **Set Lengths for Code 93**

L1 Default: 4

L2 Default: 55

Lengths for Code 93 may be set for:

- any length,
- one or two discrete lengths,
- or lengths within a specific range.

The length of a code refers to the number of characters, including check digits, the code contains.

See the table titled [ASCII Character Equivalents](#) (page 6-1).

#### **One Discrete Length (Parameter L1)**

This option decodes only those codes containing a selected length. For example, when you want to scan only Code 93 symbols containing 14 characters, scan the “Code 93 One Discrete Length” bar code and then “1” and “4” bar codes using the bar codes on the [Keypad Number Symbols](#) (page 3-72).

To begin setting one discrete length, scan this bar code:

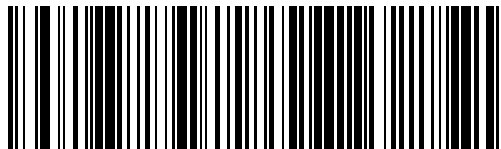

Next, scan two numeric bar codes that correspond to the desired value. Single digit numbers must have a leading zero. If you wish to change your number selection, scan Cancel on the Keypad Number Symbols page.



---

### ***Two Discrete Lengths (Parameter L2)***

This option decodes only those codes containing two selected lengths. For example, when you want to scan only Code 93 symbols containing 2 or 14 characters, scan the “Code 93 Two Discrete Lengths” bar code and then “0”, “2”, “1” and “4” bar codes using the [Keypad Number Symbols](#) (page 3-72) at the end of this chapter.

To begin setting two discrete lengths, scan this bar code:

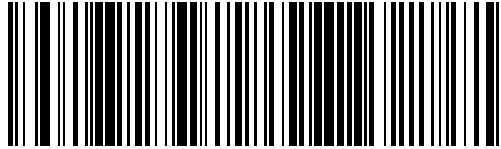

Next, scan four numeric bar codes that correspond to the desired value. Single digit numbers must have a leading zero. If you wish to change your number selection, scan Cancel on the Keypad Number Symbols page.

### ***Length Within Range***

This option decodes a code type within a specified minimum and maximum range. For example, when you want to scan only Code 93 symbols containing between 4 and 12 characters, scan the “Code 93 Length Within Range” bar code and then “0”, “4”, “1” and “2” bar codes using the [Keypad Number Symbols](#) (page 3-72) at the end of this chapter.

To begin setting lengths within a range, scan this bar code:

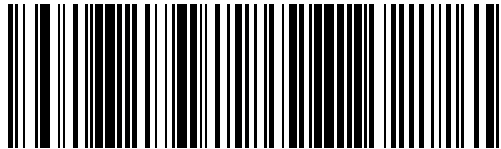

Next, scan numeric bar codes that correspond to the desired value. Single digit numbers must have a leading zero. If you wish to change your number selection, scan Cancel on the Keypad Number Symbols page.

### ***Any Length***

This option decodes Code 93 bar codes containing any number of characters.

To set any length, scan this bar code:

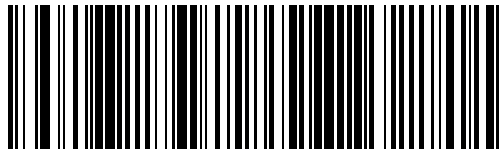

---

## Discrete 2 of 5

When enabled, Discrete 2 of 5 (D 2 of 5) symbols will be scanned, decoded and transmitted. Set this parameter by scanning either of the bar codes shown below.

Enable Discrete 2 of 5

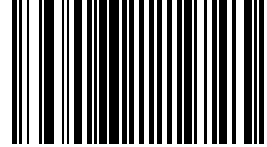

\* Disable Discrete 2 of 5

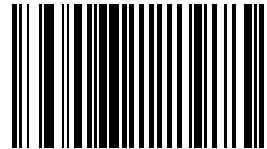

### Set Lengths for Discrete 2 of 5

L1 Default: 1 Discrete Length: 12

L2 Default : 12

Lengths for D 2 of 5 may be set for:

- any length,
- one or two discrete lengths,
- or lengths within a specific range.

The length of a code refers to the number of characters, including check digits, the code contains.

See the table titled [ASCII Character Equivalents](#) (page 6-1).

#### **One Discrete Length (Parameter L1)**

This option decodes only those codes containing a selected length. For example, when you want to scan only D 2 of 5 symbols containing 14 characters, scan the “D 2 of 5 One Discrete Length” bar code and then “1” and “4” bar codes using the bar codes on the [Keypad Number Symbols](#) (page 3-72) page.

To begin setting one discrete length, scan this bar code:

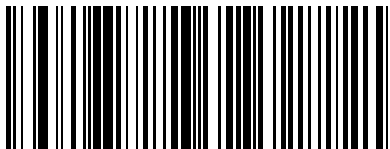

Next, scan two numeric bar codes that correspond to the desired value. Single digit numbers must have a leading zero. If you wish to change your number selection, scan Cancel on the Keypad Number Symbols page.

---

### **Two Discrete Lengths (Parameter L2)**

This option decodes only those codes containing two selected lengths. For example, when you want to scan only D 2 of 5 symbols containing 2 or 14 characters, scan the “D 2 of 5 Two Discrete Lengths” bar code and then “0”, “2”, “1” and “4” bar codes using the [Keypad Number Symbols](#) (page 3-72).

To begin setting two discrete lengths, scan this bar code:

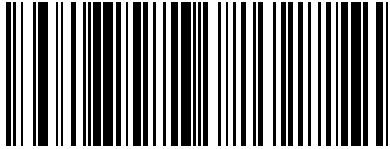

Next, scan four numeric bar codes that correspond to the desired value. Single digit numbers must have a leading zero. If you wish to change your number selection, scan Cancel on the Keypad Number Symbols page.

### **Length Within Range**

This option decodes a code type within a specified minimum and maximum range. For example, when you want to scan only D 2 of 5 symbols containing between 4 and 12 characters, scan the “D 2 of 5 Length Within Range” bar code and then “0”, “4”, “1” and “2” bar codes using the [Keypad Number Symbols](#) (page 3-72).

To begin setting lengths within a range, scan this bar code:

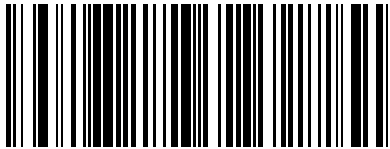

Next, scan numeric bar codes that correspond to the desired value. Single digit numbers must have a leading zero. If you wish to change your number selection, scan Cancel on the Keypad Number Symbols page.

### **Any Length**

This option decodes D 2 of 5 bar codes containing any number of characters.

*Note: Important: Selecting this option may lead to misdecodes for D 2 of 5 codes.*

To set any length, scan this bar code:

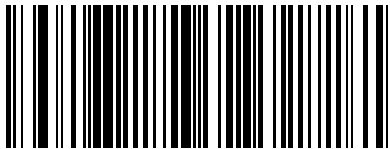

---

## ***Interleaved 2 of 5***

When enabled, Interleaved 2 of 5 (I 2 of 5) symbols will be scanned, decoded and transmitted.  
Set this parameter by scanning either of the bar codes shown below.

\* Enable Interleaved 2 of 5

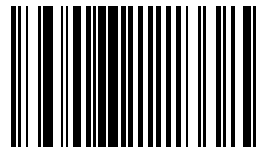

Disable Interleaved 2 of 5

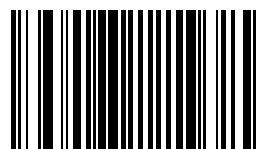

## ***I 2 of 5 Check Digit Verification***

When enabled, this parameter checks the integrity of an I 2 of 5 symbol to ensure it complies with a specified algorithm, either USS (Uniform Symbology Specification) or OPCC (Optical Product Code Council).

Set this parameter by scanning one of the bar codes shown below.

\* Disable I 2 of 5 Check Digit Verification

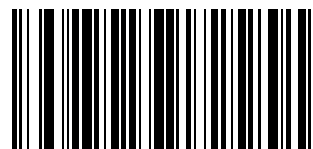

USS Check Digit

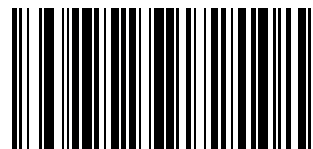

OPCC Check Digit

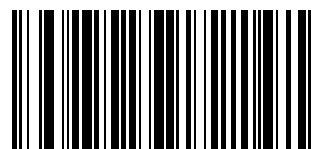

---

## Convert I 2 of 5 to EAN-13

A successful bar code conversion requires the following to be true:

- Interleaved 2 of 5 scanning is enabled.
- One of the I 2 of 5 lengths is set to 14.
- The bar code has a leading zero.
- The bar code has a valid EAN-13 check digit.

When enabled, the parameter converts a 14 character Interleaved 2 of 5 bar code into EAN-13 and transmits it to the host as EAN-13.

Set this parameter by scanning either of the bar codes shown below.

Enable Convert Interleaved 2 of 5 to EAN-13

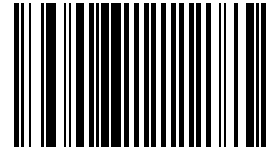

\* Disable Convert Interleaved 2 of 5 to EAN-13

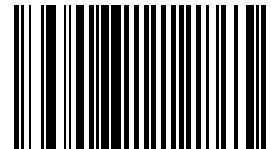

## Set Lengths for I 2 of 5

L1 Default: 14

L2 Default: 14

Lengths for I 2 of 5 may be set for:

- any length,
- one or two discrete lengths,
- or lengths within a specific range.

The length of a code refers to the number of characters, including check digits, the code contains. When settings lengths, single digit numbers must always be preceded by a leading zero.

See the table titled [ASCII Character Equivalents](#) (page 6-1).

### One Discrete Length (Parameter L1)

This option decodes only those codes containing a selected length. For example, when you want to decode I 2 of 5 symbols containing only 14 characters, scan the “I 2 of 5 One Discrete Length” bar code and then the “1” and “4” bar codes using the [Keypad Number Symbols](#) (page 3-72).

To begin setting one discrete length, scan this “I 2 of 5 One Discrete Length” bar code:



Next, scan two numeric bar codes that correspond to the desired value. Single digit numbers must have a leading zero. If you wish to change your number selection, scan Cancel on the Keypad Number Symbols page.

---

### **Two Discrete Lengths (Parameter L2)**

This option decodes only those codes containing two selected lengths. For example, when you want to scan only I 2 of 5 symbols containing 6 or 14 characters, scan the "I 2 of 5 Two Discrete Lengths" bar code and then "0", "6", "1" and "4" bar codes to decode only I 2 of 5 symbols containing 6 or 14 characters. Use the [Keypad Number Symbols](#) (page 3-72) at the end of this section.

To begin setting two discrete lengths, scan this "I 2 of 5 Two Discrete Lengths" bar code:



Next, scan four numeric bar codes that correspond to the desired value. Single digit numbers must have a leading zero. If you wish to change your number selection, scan Cancel on the Keypad Number Symbols page.

### **Length Within Range**

This option decodes a code type within a specified minimum and maximum range. For example, when you want to scan only I 2 of 5 symbols containing between 4 and 12 characters, scan the "I 2 of 5 Length Within Range" bar code and then "0", "4", "1" and "2" bar codes using the [Keypad Number Symbols](#) (page 3-72) at the end of this section.

To begin setting lengths within a range, scan this "I 2 of 5 Length Within Range" bar code:



Next, scan numeric bar codes that correspond to the desired value. Single digit numbers must have a leading zero. If you wish to change your number selection, scan Cancel on the Keypad Number Symbols page.

### **Any Length**

This option decodes I 2 of 5 bar codes containing any number of characters.

*Note: Important: Selecting this option may lead to misdecodes for I 2 of 5 codes.*

To set any length, scan this "I 2 of 5 Any Length" bar code:



See Also: [Set Lengths for I 2 of 5 \(superseded\)](#) (page 3-70)

---

***Transmit 1 2 of 5 Check Digit***

When enabled, the check digit is transmitted with the data.

Parameter setting for "1 2 of 5 Check Digit Verification" has no effect on this parameter value.

Set this parameter by scanning either of the bar codes shown below.

Enable Transmit 1 2 of 5 Check Digit

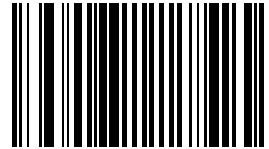

\* Disable Transmit 1 2 of 5 Check Digit

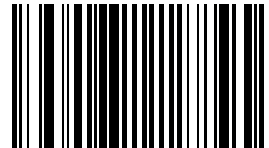

---

## ***MSI Plessey***

When enabled, MSI Plessey symbols will be scanned, decoded and transmitted.  
Set this parameter by scanning either of the bar codes shown below.

Enable MSI

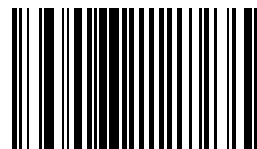

\* Disable MSI

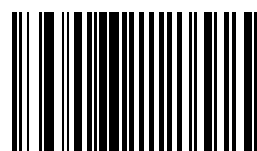

## ***MSI Plessey Check Digit Algorithm***

When the “Two MSI Plessey Check Digits” option is selected, an additional verification is required to ensure integrity.  
Either of the two following algorithms may be selected.

Set this parameter by scanning either of the algorithm bar codes shown below.

Mod 10/Mod 11

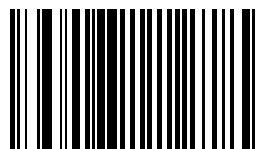

\* Mod 10/Mod 10

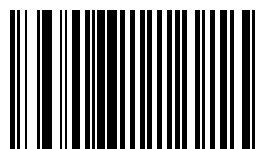



---

## **MSI Plessey Check Digits**

Check digits placed at the end of the MSI Plessey bar code verify the integrity of the data. At least one check digit is always required. Check digits are not automatically transmitted with the data.

*Note: When Two Check Digits is selected, an “MSI Plessey Check Digit Algorithm” must also be selected.*

Set the number of check digits to be included with the bar code by scanning either of the bar codes shown below.

\* One MSI Plessey check digit

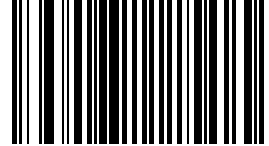

Two MSI Plessey check digits

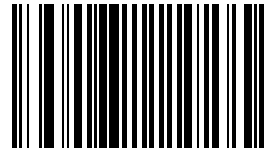

## **Set Lengths for MSI Plessey**

L1 Default: 06

L2 Default: 55

Lengths for MSI Plessey may be set for:

- any length,
- one or two discrete lengths,
- or lengths within a specific range.

The length of a code refers to the number of characters, including check digits, the code contains.

See the table titled [ASCII Character Equivalents](#) (page 6-1).

### **One Discrete Length (Parameter L1)**

This option decodes only those codes containing a selected length. For example, when you want to scan only MSI Plessey symbols containing 14 characters, scan the “MSI Plessey One Discrete Length” bar code and then “1” and “4” bar codes using the [Keypad Number Symbols](#) (page 3-72).

To begin setting one discrete length, scan this bar code:

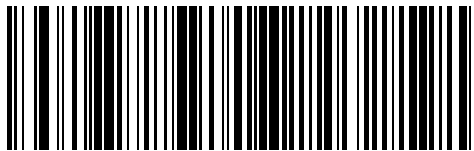

Next, scan two numeric bar codes that correspond to the desired value. Single digit numbers must have a leading zero. If you wish to change your number selection, scan Cancel on the Keypad Number Symbols page.

---

### **Two Discrete Lengths (Parameter L2)**

This option decodes only those codes containing two selected lengths. For example, when you want to scan only MSI Plessey symbols containing 2 or 14 characters, scan the “MSI Plessey Two Discrete Lengths” bar code and then “0”, “2”, “1” and “4” bar codes using the [Keypad Number Symbols](#) (page 3-72).

To begin setting two discrete lengths, scan this bar code:

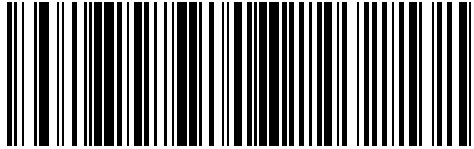

Next, scan four numeric bar codes that correspond to the desired value. Single digit numbers must have a leading zero. If you wish to change your number selection, scan Cancel on the Keypad Number Symbols page.

### **Length Within Range**

This option decodes a code type within a specified minimum and maximum range. For example, when you want to scan only MSI Plessey symbols containing between 4 and 12 characters, scan the “MSI Plessey Length Within Range” bar code and then “0”, “4”, “1” and “2” bar codes using the [Keypad Number Symbols](#) (page 3-72).

To begin setting lengths within a range, scan this bar code:

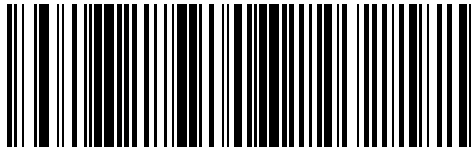

Next, scan numeric bar codes that correspond to the desired value. Single digit numbers must have a leading zero. If you wish to change your number selection, scan Cancel on the Keypad Number Symbols page.

### **Any Length**

This option decodes MSI Plessey bar codes containing any number of characters.

*Note: Important: Selecting this option may lead to misdecodes for MSI Plessey codes.*

To set any length, scan this bar code:

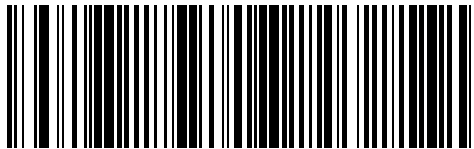

---

### ***Transmit MSI Plessey Check Digit***

When enabled, the check digit is transmitted with the data.

Set this parameter by scanning either of the bar codes shown below.

Enable Transmit MSI Plessey Check Digit

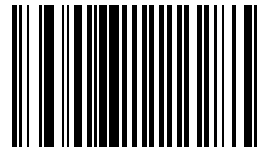

\* Disable Transmit MSI Plessey Check Digit

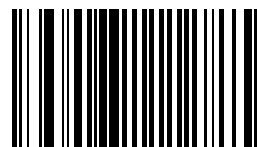

---

**UPC/EAN**

**UPC-A**

Select an option by scanning either of the bar codes shown below.

\* Enable UPC-A

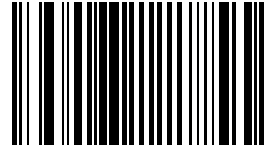

Disable UPC-A

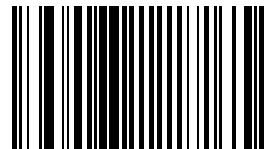

**UPC-E**

Select an option by scanning either of the bar codes shown below.

\* Enable

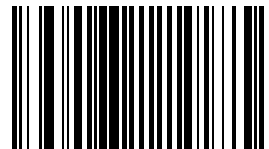

Disable

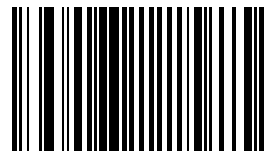

---

**UPC-E1**

Select an option by scanning either of the bar codes shown below.

Enable UPC-E1

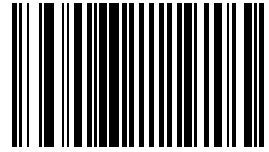

\* Disable UPC-E1

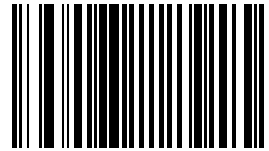

**EAN-8**

Select an option by scanning either of the bar codes shown below.

\* Enable EAN-8

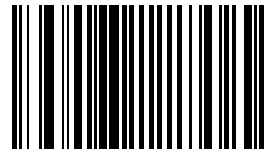

Disable EAN-8

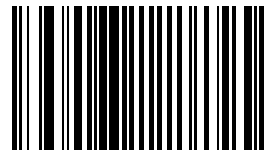

---

***EAN-13***

Select an option by scanning either of the bar codes shown below.

\* Enable EAN-13

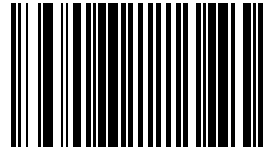

Disable EAN-13

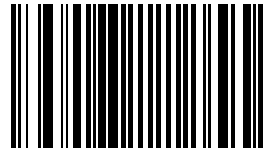

***Bookland EAN***

Select an option by scanning either of the bar codes shown below.

Enable Bookland EAN

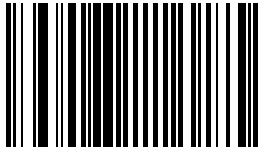

\* Disable Bookland EAN

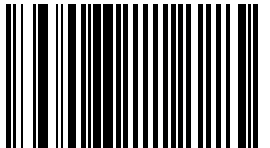

---

### **Bookland ISBN Format**

Select one of the following formats for Bookland data when Bookland EAN is enabled.

#### **Bookland ISBN-10**

The scanner reports Bookland data starting with 978 in traditional 10-digit format with the special Bookland check digit for backward-compatibility. Data starting with 979 is not considered Bookland in this mode.

#### **Bookland ISBN-13**

The scanner reports Bookland data (starting with either 978 or 979) as EAN-13 in 13-digit format to meet the 2007 ISBN-13 protocol.

\* Bookland ISBN-10

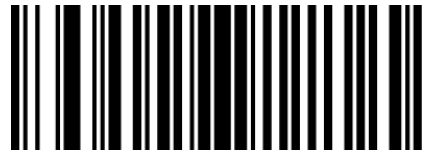

Bookland ISBN-13



For Bookland EAN to function properly, first enable Bookland EAN using Enable/Disable Bookland EAN, then select either Decode UPC/EAN Supplementals, Autodiscriminate UPC/EAN Supplementals, or Enable 978/979 Supplemental Mode in Decode UPC/EAN Supplementals.

### **Check Digits**

#### **Transmit UPC-A Check Digit**

This parameter determines whether the symbol will be transmitted with or without the UPC-A check digit. Select an option by scanning either of the bar codes shown below.

\* Enable Transmit UPC-A Check Digit

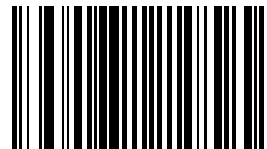

Disable Transmit UPC-A Check Digit

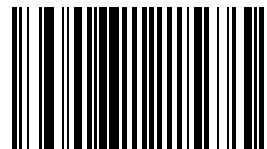

---

### ***Transmit UPC-E Check Digit***

This parameter determines whether the symbol will be transmitted with or without the UPC-E check digit. Select an option by scanning either of the bar codes shown below.

\* Enable Transmit UPC-E Check Digit

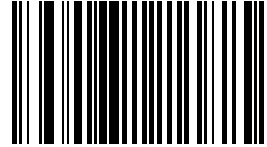

Disable Transmit UPC-E Check Digit

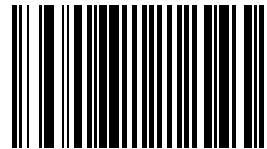

### ***Transmit UPC-E1 Check Digit***

This parameter determines whether the symbol will be transmitted with or without the UPC-E1 check digit. Select an option by scanning either of the bar codes shown below.

\* Enable Transmit UPC-E1 Check Digit

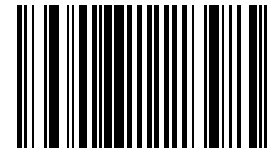

Disable Transmit UPC-E1 Check Digit

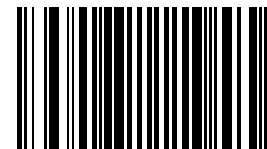



---

## **Conversions**

### **Convert UPC-E to UPC-A**

When this parameter is enabled, UPC-E (zero suppressed) decoded data is converted to UPC-A format before transmission. After conversion, data follows UPC-A format and is affected by UPC-A programming selections (e.g., Preamble, Check Digit, etc.).

When disabled, UPC-E (zero suppressed) decoded data is transmitted without conversion.

Select an option by scanning either of the bar codes shown below.

Enable UPC-E to UPC-A conversion

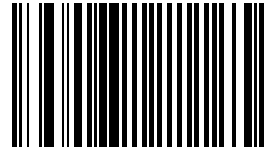

\* Disable UPC-E to UPC-A conversion

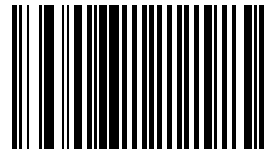

### **Convert UPC-E1 to UPC-A**

When this parameter is enabled, UPC-E1 (zero suppressed) decoded data is converted to UPC-A format before transmission. After conversion, data follows UPC-A format and is affected by UPC-A programming selections (e.g., Preamble, Check Digit, etc.).

When disabled, UPC-E1 (zero suppressed) decoded data is transmitted without conversion.

Select an option by scanning either of the bar codes shown below.

Enable UPC-E1 to UPC-A conversion

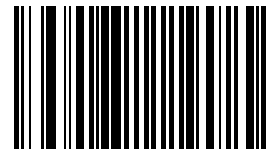

\* Disable UPC-E1 to UPC-A conversion

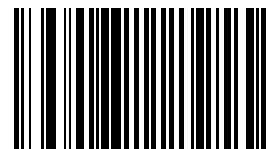

---

### ***Convert EAN-8 to EAN-13 Type***

When “EAN-8 Zero Extend” is enabled, this parameter setting labels the extended symbol as either an EAN-13 bar code or an EAN-8 bar code.

When “EAN-8 Zero Extend” is disabled, this parameter’s conversion setting is ignored.

Select an option by scanning either of the bar codes shown below.

\* Type is EAN-13

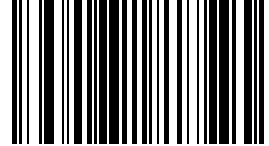

Type is EAN-8

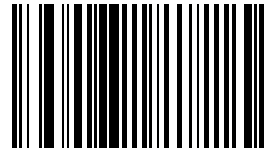

---

## Preambles

### UPC-A Preamble

A preamble is a lead-in character for UPC-A symbols transmitted to the host device. The lead-in characters are considered part of the symbol.

Data is sent to the host in the following format:

No Preamble	[data]
System Character	[schar] [data]
System Character and Country Code	[country code] [schar] [data]

Select an option by scanning one of the bar codes shown below.

No UPC-A Preamble

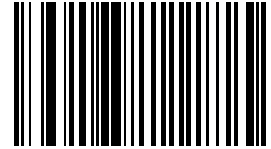

\* System Character

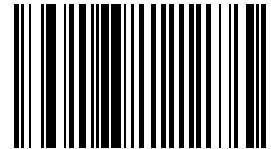

System Character and Country Code  
("0" for USA)

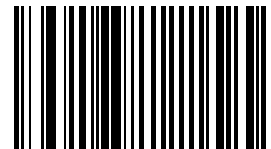

---

### **UPC-E Preamble**

A preamble is a lead-in character for UPC-E symbols transmitted to the host device. The lead-in characters are considered part of the symbol.

Data is sent to the host in the following format:

No Preamble	[data]
System Character	[schar] [data]
System Character and Country Code	[country code] [schar] [data]

Select an option by scanning one of the bar codes shown below.

No UPC-E Preamble

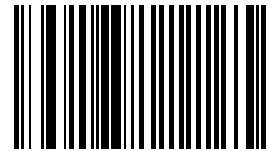

\* System Character

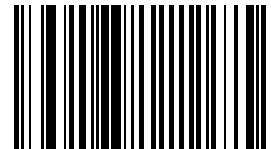

System Character and Country Code  
("0" for USA)

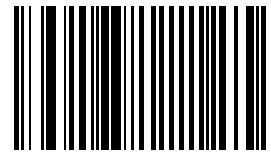

---

### **UPC-E1 Preamble**

A preamble is a lead-in character for UPC-E1 symbols transmitted to the host device. The lead-in characters are considered part of the symbol.

Data is sent to the host in the following format:

No Preamble	[data]
System Character	[schar] [data]
System Character and Country Code	[country code] [schar] [data]

Select an option by scanning one of the bar codes shown below.

No UPC-E1 Preamble

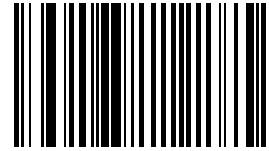

\* System Character

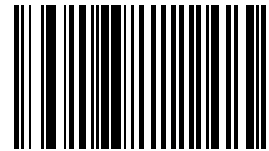

System Character and Country Code  
("0" for USA)

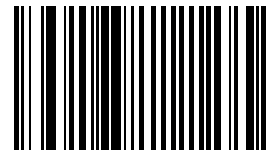

---

## Supplementals

### Decode UPC/EAN Supplementals

*Note: In order to minimize the risk of invalid data transmission, for best results select whether to read or ignore supplemental characters.*

Supplementals are additionally appended characters (2 or 5) according to specific code format conventions (e.g., UPC-A + 2).

Select an option by scanning one of the bar codes shown below.

#### Decode UPC/EAN with Supplementals

UPC/EAN symbols without supplemental characters are not decoded.

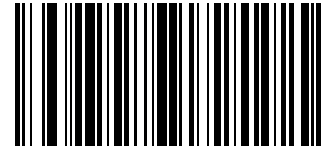

#### \* Ignore UPC/EAN with Supplementals

When a UPC/EAN plus supplemental symbol is scanned, the UPC/EAN is decoded and the supplemental characters ignored.

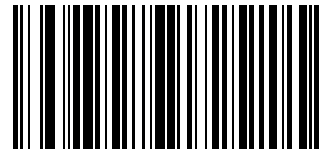

#### Autodiscriminate UPC/EAN Supplementals

When this option is selected you must assign a value to the "Decode UPC/EAN Supplemental Redundancy" parameter. A value of 5 or more is recommended.

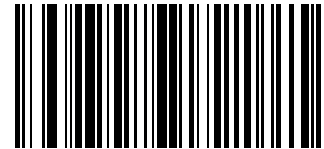

#### Enable 378/379 Supplemental Mode

The scanner will identify supplementals for EAN-13 bar codes that start with a 378 or 379 prefix only. All other UPC/EAN codes are decoded immediately and the supplemental characters ignored.

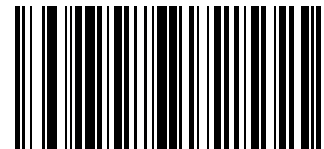

#### Enable 978/979 Supplemental Mode

If you select 978/979 Supplemental Mode and are scanning Bookland EAN bar codes, see Enable/Disable Bookland EAN to enable Bookland EAN, and select a format using Bookland ISBN Format.

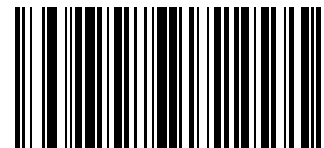

---

Enable 977 Supplemental Mode

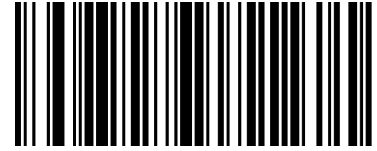

Enable 414/419/434/439 Supplemental Mode

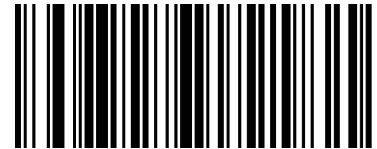

Enable 491 Supplemental Mode



**Enable Smart Supplemental Mode**  
Applies to EAN-13 bar codes starting with any prefix listed previously.

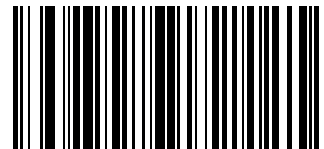

Supplemental User Programmable Type 1



Supplemental User Programmable Type 1 and 2



Smart Supplemental Plus User Programmable 1

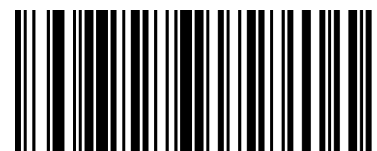

---

Smart Supplemental Plus User Programmable 1  
and 2

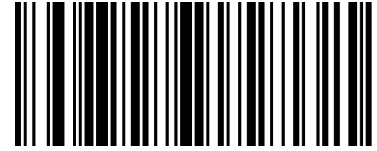

### ***User-Programmable Supplementals***

When Supplemental User-Programmable option is selected from Decode UPC/EAN Supplementals, select User-Programmable Supplemental 1 to set the 3-digit prefix. Then select the 3 digits using the [Keypad Number Symbols](#) (page 3-72).

#### ***User-Programmable Supplemental 1***

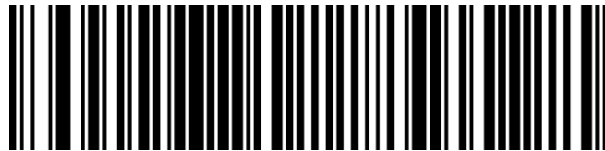

#### ***User-Programmable Supplemental 2***



When Supplemental User-Programmable option is selected from Decode UPC/EAN Supplementals, select User-Programmable Supplemental 2 to set the 3-digit prefix. Then select the 3 digits using the [Keypad Number Symbols](#) (page 3-72).

### ***Decode UPC/EAN Supplemental Redundancy***

Default: 7 Times

With Autodiscriminate UPC/EAN Supplementals selected, this option adjusts the number of times a symbol without supplementals will be decoded before transmission. The range is from 2 to 20 times. Five or above is recommended when decoding a mix of UPC/EAN symbols with and without supplementals, and the autodiscriminate option is selected.

To begin setting the decode redundancy value, scan this bar code:

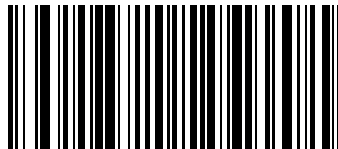

Next, scan two numeric bar codes that correspond to the desired value using the [Keypad Number Symbols](#) (page 3-72). Single digit numbers must have a leading zero.

If you wish to change your selection, scan Cancel on the Keypad Number Symbols page.



---

### ***EAN-8 Zero Extend***

When this parameter is enabled, five leading zeros are added to decoded EAN-8 symbols to make them compatible in format to EAN-13 symbols. Use parameter “Convert EAN-8 to EAN-13 Type” to label the extended symbol.

When disabled, EAN-8 symbols are transmitted as is and parameter “Convert EAN-8 to EAN-13 Type” setting is ignored.

Select an option by scanning either of the bar codes shown below.

Enable EAN-8 Zero Extend

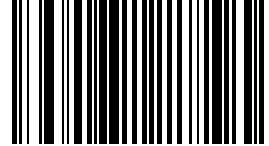

\* Disable EAN-8 Zero Extend

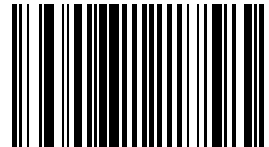

### ***UCC Coupon Extended Code***

*Note: UCC Coupon Extended Code replaces UPC/EAN Coupon Code.*

The UCC Coupon Extended Code is an additional bar code adjacent to a UCC Coupon Code. To enable or disable UCC Coupon Extended Code, scan the appropriate bar code below.

Enable UCC Coupon Extended Code

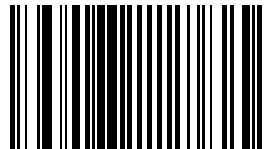

\* Disable UCC Coupon Extended Code

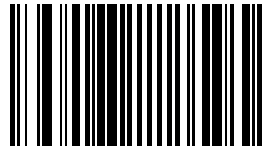

---

### UPC/EAN Security Level

Use this parameter to determine the security level appropriate for UPC/EAN bar code quality. There is an inverse relationship between security and scanner aggressiveness, so be sure to choose only that level of security necessary for any given application.

There are four decode security levels. Higher security levels are selected for decreasing levels of bar code quality. As security levels increase, the scanners aggressiveness decreases.

Level 0	The default setting. Allows the scanner to operate in its most aggressive state, while providing sufficient security in decoding "in-spec" UPC/EAN bar codes.
Level 1	Misdecode 1,2,7,8 As bar code quality levels diminish, certain characters become prone to misdecodes before others (i.e., 1, 2, 7, 8). Select this level upon misdecodes of poorly printed labels that are limited to 1, 2, 7 and 8.
Level 2	Misdecodes not 1,2,7,8 Select this security level upon experiencing misdecodes of poorly printed bar codes and the misdecodes are not limited to characters 1,2,7 and 8.
Level 3	Select this security level if you have tried security level 2 and are still experiencing misdecodes. Using this level is an extreme measure against misdecoding severely out of spec bar codes. This level significantly impairs the decoding ability of the scanner. If this level of security is necessary, you should try to improve the quality of your bar codes.

Select an option by scanning one of the bar codes shown below. If you wish to change your selection, scan Cancel.

\* Level 0

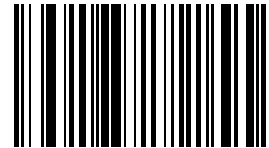

Level 1

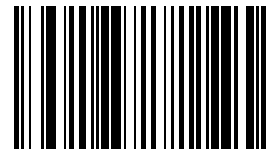

Level 2

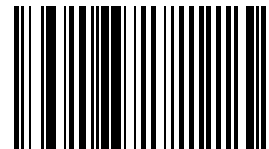

Level 3

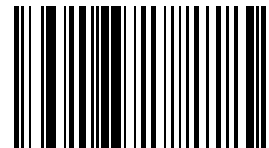

---

Cancel

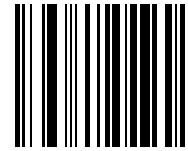

***GS1 DataBar (RSS) Codes***

Default: All Parameters : Disable

***GS1 DataBar Omnidirectional (RSS-14)***

Enable GS1 DataBar Omnidirectional (RSS-14)

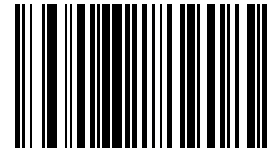

\* Disable GS1 DataBar Omnidirectional (RSS-14)

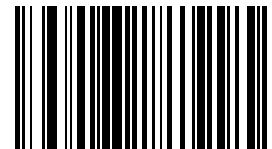

***GS1 DataBar Limited (RSS-Limited)***

Enable GS1 DataBar Limited (RSS-Limited)

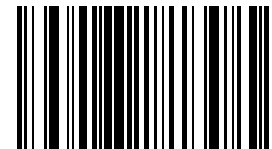

\* Disable GS1 DataBar Limited (RSS-Limited)

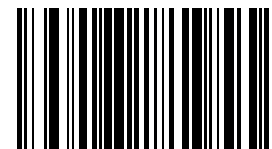

---

### ***GS1 DataBar Expanded (RSS-Expanded)***

Enable GS1 DataBar Expanded (RSS-Expanded)

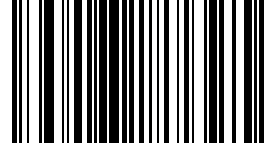

\* Disable GS1 DataBar Expanded (RSS-Expanded)

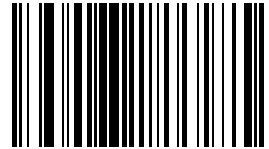

### ***Convert GS1 DataBar (RSS) to UPC/EAN***

This parameter only applies to GS1 DataBar Omnidirectional (RSS-14) and GS1 DataBar Limited (RSS Limited) symbols. When this conversion is enabled, GS1 DataBar Omnidirectional (RSS-14) and GS1 DataBar Limited (RSS Limited) symbols encoding a single zero as the first digit have the leading '010' stripped and the bar code reported as EAN-13.

Bar codes beginning with two or more zeros but not six zeros have the leading '0100' stripped and the bar code reported as UPC-A. The UPC-A Preamble parameter to transmit the system character and country code applies to converted bar codes. Note that neither the system character nor the check digit can be stripped.

Enable Convert GS1 DataBar (RSS) to UPC/  
EAN

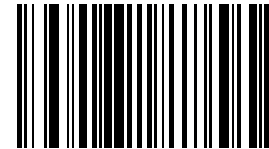

\* Disable Convert GS1 DataBar (RSS) to  
UPC/EAN

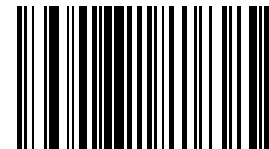

---

## Appendix

This appendix contains information that is superseded by newer information. It contains programming bar codes for Symbol SE955 scan engines only.

### ***Laser On Time (superseded)***

For correct operation, reboot the Bluetooth Ring Scanner after changing this value.

The bar code on this page has been replaced with a newer bar code. See Also: [Laser On Time](#) (page 3-14).

Default: 3.0 seconds

This parameter sets the maximum time decode processing continues during a scan attempt. It is programmable in 0.1 second increments from 0.5 to 9.9 seconds. If a label has not been decoded before this time expires and the session is terminated, the system regards it as a failed scan attempt.

To begin setting Laser On Time, scan this bar code:

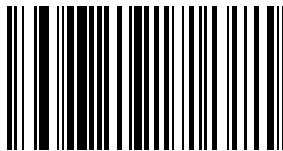

Next, scan two numeric bar codes that correspond to the desired on time using the [Keypad Number Symbols](#) (page 3-72) at the end of this section. Times less than 1.0 second must have a leading zero.

If you wish to change your number selection, scan Cancel on the Keypad Number Symbols page.

### ***Scan Angle (SE955 only) superseded***

*Note:* The bar code on this page has been replaced with a newer bar code. See Also: [Scan Angle \(SE955 only\)](#) (page 3-17).

Choose one of the options below to set the scan angle to narrow or wide. Once the parameter bar code is scanned, the Scan Angle setting is persistently stored.

Select an option by scanning one of the bar codes shown below.

Narrow Angle (35°)



\* Wide Angle



---

## **Set Lengths for I 2 of 5 (superseded)**

*Note: The bar codes on this page have been replaced with newer bar codes. See Also: [Set Lengths for I 2 of 5 \(page 3-45\)](#).*

L1 Default: 14

L2 Default: 14

Lengths for I 2 of 5 may be set for:

- any length,
- one or two discrete lengths,
- or lengths within a specific range.

The length of a code refers to the number of characters, including check digits, the code contains.

See the table titled [ASCII Character Equivalents](#) (page 6-1).

### **One Discrete Length (Parameter L1)**

This option decodes only those codes containing a selected length. For example, when you want to scan only I 2 of 5 symbols containing 14 characters, scan the "I 2 of 5 One Discrete Length" bar code and then the "1" and "4" bar codes using the [Keypad Number Symbols](#) (page 3-72).

To begin setting one discrete length, scan this "I 2 of 5 One Discrete Length" bar code:

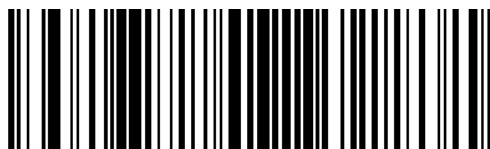

Next, scan two numeric bar codes that correspond to the desired value. Single digit numbers must have a leading zero. If you wish to change your number selection, scan Cancel on the Keypad Number Symbols page.

### **Two Discrete Lengths (Parameter L2)**

This option decodes only those codes containing two selected lengths. For example, when you want to scan only I 2 of 5 symbols containing 2 or 14 characters, scan the "I 2 of 5 Two Discrete Lengths" bar code and then "0", "2", "1" and "4" bar codes using the [Keypad Number Symbols](#) (page 3-72) at the end of this section.

To begin setting two discrete lengths, scan this "I 2 of 5 Two Discrete Lengths" bar code:



Next, scan four numeric bar codes that correspond to the desired value. Single digit numbers must have a leading zero. If you wish to change your number selection, scan Cancel on the Keypad Number Symbols page.

---

### **Length Within Range**

This option decodes a code type within a specified minimum and maximum range. For example, when you want to scan only 1 2 of 5 symbols containing between 4 and 12 characters, scan the "1 2 of 5 Length Within Range" bar code and then "0", "4", "1" and "2" bar codes using the [Keypad Number Symbols](#) (page 3-72) at the end of this section.

To begin setting lengths within a range, scan this "1 2 of 5 Length Within Range" bar code:

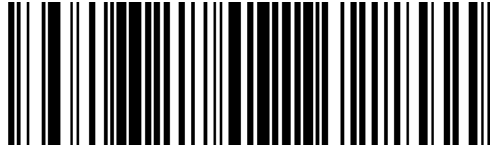

Next, scan numeric bar codes that correspond to the desired value. Single digit numbers must have a leading zero. If you wish to change your number selection, scan Cancel on the Keypad Number Symbols page.

### **Any Length**

This option decodes 1 2 of 5 bar codes containing any number of characters.

*Note: Important: Selecting this option may lead to misdecodes for 1 2 of 5 codes.*

To set any length, scan this "1 2 of 5 Any Length" bar code:

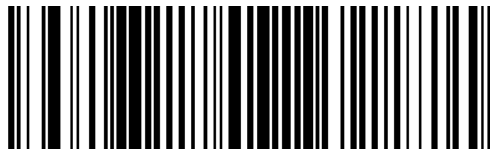

---

## ***Keypad Number Symbols***

The bar code labels shown below represent a numeric keypad, with decimal values 0 through 9. Each label can be scanned individually to enter a numeric value. Use these numeric value symbols to enter numeric input in the course of performing a scan engine system configuration.

0

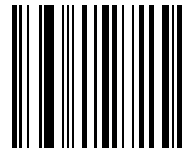

1

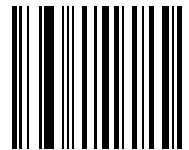

2

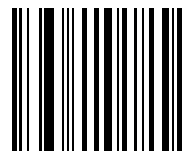

3

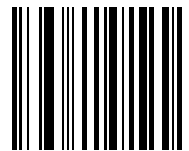

4

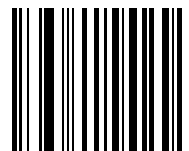

5





---

6

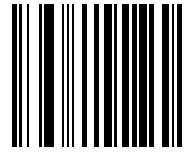

7

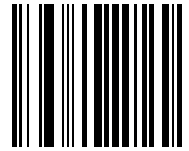

8

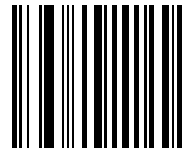

9

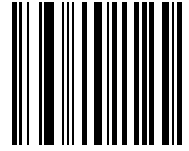

Cancel

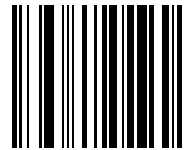



## 2D Laser Imager Programming Bar Codes

### Introduction

These bar codes, explanations and instructions are for programming the SE4400 laser imager engine in your ring imager. Do not scan the bar codes in this section with any other imager or laser engine.

*Note: A ring imager does not have beep / audio capability.*

Assumption: The user is familiar with Windows on-screen functions.

Scan engine manufacturers may offer more bar codes and options than are contained in this chapter. Note that the bar codes in this chapter are only those supported by Honeywell and the mobile devices it manufactures or supports. Contact [Customer Support](#) (page 7-1) if you need help when using the bar codes in this chapter.

To change a parameter value scan the appropriate bar code in this chapter. The new value replaces the standard default value in memory.

An asterisk (\*) next to an option indicates the default setting.

Using the imager like a camera (or for OCR decoding) is not supported in this release.

The following SE4400 bar code symbologies are supported:

Symbology	
Codabar	Aztec / Aztec Inverse
Code 11	PDF417
Code 128	MicroPDF
Code 39	Code 128 Emulation
Code 93	Data Matrix / Data Matrix Inverse
Composites	Maxicode
Discrete 2 of 5	MicroQR
Interleaved 2 of 5	QR Code / QR Inverse
MSI Plessey	GS1 DataBar (RSS)
UPC / EAN	Postal Codes

*Note: The default value for all Postal Code symbologies is "Enabled." For best performance when reading a specific postal symbology, all other postal symbologies should be disabled.*

*Note: Prefix / Suffix*

Ring decoder engine prefix and suffix parameters should not be set, changed, or reset using the Prefix and Suffix bar codes shown in this section. When the Ring Scanner Module is reset to defaults, the prefix and suffix settings revert to their default values and need to be scanned again. Use the ScanWedge NGW Power Tool (Dolphin 70e) or Scanner control panel (HX2 or HX3) in the host computer to store prefix and suffix values.

Refer to the host User's Guide for information and instruction on setting up the following ring imager parameters:

- Enable/Disable decoding sounds
- Imager LED Illumination
- COM1 Serial Parameters
- Code ID: AIM, Symbol, Custom
- Symbology Settings including Prefix/Suffix
- Control Character Mapping
- Custom Identifiers
- Pre-Configured Defaults

<b>Ring Imager Setting 4400</b>	<b>Default</b>
<a href="#">Set All Defaults/Cancel Bar Codes</a> (page 4-5)	All Defaults
<a href="#">Enable / Disable Parameter Scanning</a> (page 4-6)	Enable
<b>Imager Parameters - General</b>	
<a href="#">Decode Session Timeout</a> (page 4-6)	9.9 sec
<a href="#">Decode Aiming Pattern</a> (page 4-7)	Enable
<a href="#">Decoding Autoexposure</a> (page 4-7)	Enable
<a href="#">Decoding Illumination</a> (page 4-8)	Enable
<a href="#">Focus Mode</a> (page 4-9)	Far Focus
<a href="#">LED Illumination</a> (page 4-10) (LED Illumination PL4407)	Internal LED Illumination
<a href="#">LED Illumination</a> (page 4-10) (LED Illumination MS4407)	External LED Illumination
<a href="#">Operational Mode</a> (page 4-11)	Decode Mode
<a href="#">Power Mode</a> (page 4-12) (Power Mode PL4407)	Low Power
<a href="#">Power Mode</a> (page 4-12) (Power Mode MS4407)	Continuous On
<a href="#">Presentation Mode Session Timeout</a> (page 4-12)	2 sec
<a href="#">Time Delay to Low Power Mode</a> (page 4-13)	1 sec
<a href="#">Time-out between Decodes, Same Symbol</a> (page 4-14)	0.6 sec
<a href="#">Trigger Modes</a> (page 4-15) Trigger Mode PL4407)	Level
<a href="#">Trigger Modes</a> (page 4-15) (Trigger Mode MS4407)	Presentation Mode
<a href="#">Report Version</a> (page 4-16)	Current Software Version
<a href="#">Transmit Code ID Character</a> (page 4-16)	None
<a href="#">Prefix / Suffix Values</a> (page 4-22)	Prefix: Null, Suffix 1 : LF, Suffix 2: CR
<a href="#">Scan Data Transmission Format</a> (page 4-23)	Data As Is
<a href="#">Transmit "No Read" Message</a> (page 4-25)	Disable
Simple Serial Interface (SSI) Options	Not Supported
Event Reporting	Not Supported
Serial Host Parameters	Not Supported
Beep After Good Decode	Not Supported
Beeper Tone	Not Supported
Beeper Volume	Not Supported
FN1 Substitution Values	Not Supported
Prefix / Suffix Values	Not Supported
<b>Symbologies</b>	
<i>UPC/EAN</i>	
<a href="#">UPC-A</a> (page 4-26)	Enable
<a href="#">UPC-E</a> (page 4-26)	Enable
<a href="#">UPC-E1</a> (page 4-27)	Disable
<a href="#">EAN-8/JAN-8</a> (page 4-27)	Enable
<a href="#">EAN-13/JAN-13</a> (page 4-28)	Enable
<a href="#">Bookland EAN</a> (page 4-28)	Disable
<a href="#">Bookland Format</a> (page 4-29)	Bookland 10
<a href="#">Decode UPC/EAN/JAN Supplementals (2 and 5 digits)</a> (page 4-29)	Ignore Supplementals
<a href="#">UPC/EAN/JAN Supplemental Redundancy</a> (page 4-31)	10
<a href="#">Transmit UPC-A Check Digit</a> (page 4-31)	Enable

<b>Ring Imager Setting 4400</b>	<b>Default</b>
<a href="#">Transmit UPC-E Check Digit</a> (page 4-32)	Enable
<a href="#">Transmit UPC-E1 Check Digit</a> (page 4-32)	Enable
<a href="#">UPC-A Preamble</a> (page 4-33)	System Character
<a href="#">UPC-E Preamble</a> (page 4-34)	System Character
<a href="#">UPC-E1 Preamble</a> (page 4-35)	System Character
<a href="#">Convert UPC-E to UPC-A</a> (page 4-36)	Disable
<a href="#">Convert UPC-E1 to UPC-A</a> (page 4-36)	Disable
<a href="#">EAN-8/JAN-8 Extend</a> (page 4-37)	Disable
<a href="#">UCC Coupon Extended Code</a> (page 4-37)	Disable
<b>Code 128</b>	
<a href="#">Code 128</a> (page 4-38)	Enable
<a href="#">UCC/EAN-128</a> (page 4-38)	Enable
<a href="#">ISBT-128</a> (page 4-39)	Enable
<b>Code 39</b>	
<a href="#">Code 39</a> (page 4-39)	Enable
<a href="#">Trioptic Code 39</a> (page 4-40)	Disable
<a href="#">Convert Code 39 to Code 32</a> (page 4-40) (Italian Pharmacy Code)	Disable
<a href="#">Code 32 Prefix</a> (page 4-41)	Disable
<a href="#">Set Length(s) for Code 39</a> (page 4-42)	2 to 55
<a href="#">Code 39 Check Digit Verification</a> (page 4-43)	Disable
<a href="#">Transmit Code 39 Check Digit</a> (page 4-44)	Disable
<a href="#">Code 39 Full ASCII Conversion</a> (page 4-44)	Disable
<b>Code 93</b>	
<a href="#">Code 93</a> (page 4-45)	Disable
<a href="#">Set Lengths for Code 93</a> (page 4-45)	4 to 55
<b>Code 11</b>	
<a href="#">Code 11</a> (page 4-47)	Disable
<a href="#">Set Lengths for Code 11</a> (page 4-47)	4 to 55
<a href="#">Code 11 Check Digit Verification</a> (page 4-49)	Disable
<a href="#">Transmit Code 11 Check Digits</a> (page 4-49)	Disable
<b>Interleaved 2 of 5 (ITF)</b>	
<a href="#">Interleaved 2 of 5 (ITF)</a> (page 4-50)	Enable
<a href="#">Set Lengths for I 2 of 5</a> (page 4-50)	14
<a href="#">I 2 of 5 Check Digit Verification</a> (page 4-52)	Disable
<a href="#">Transmit I 2 of 5 Check Digit</a> (page 4-52)	Disable
<a href="#">Convert I 2 of 5 to EAN 13</a> (page 4-53)	Disable
<b>Discrete 2 of 5 (DTF)</b>	
<a href="#">Discrete 2 of 5 (DTF)</a> (page 4-53)	Disable
<a href="#">Set Lengths for Discrete 2 of 5</a> (page 4-54)	12
<b>Codabar (NW - 7)</b>	
<a href="#">Codabar</a> (page 4-56)	Disable
<a href="#">CLSI Editing</a> (page 4-56)	Disable
<a href="#">NOTIS Editing</a> (page 4-57)	Disable
<a href="#">Set Lengths for Codabar</a> (page 4-57)	5 to 55

Ring Imager Setting 4400	Default
<b>MSI</b>	
MSI (page 4-59)	Disable
Set Length(s) for MSI (page 4-59)	4 to 55
MSI Check Digits (page 4-61)	One
Transmit MSI Check Digit (page 4-61)	Disable
MSI Check Digit Algorithm (page 4-62)	Mod 10/Mod 10
<b>Postal Codes</b>	
US Postnet (page 4-62)	Enable
US Planet (page 4-63)	Enable
UK Postal (page 4-63)	Enable
Transmit UK Postal Check Digit (page 4-64)	Enable
Japan Postal (page 4-64)	Enable
Australian Postal (page 4-65)	Enable
Dutch Postal (page 4-65)	Enable
Transmit US Postal Check Digit (page 4-66)	Enable
4 State Postal (page 4-66)	
<b>GS1 DataBar (RSS)</b>	
GS1 DataBar Omnidirectional (RSS-14) (page 4-67)	Enable
GS1 DataBar Limited (RSS Limited) (page 4-67)	Enable
GS1 DataBar Expanded (RSS Expanded) (page 4-68)	Enable
Convert GS1 DataBar (RSS) to UPC/EAN (page 4-68)	Disable
<b>Composite</b>	
Composite CC-C (page 4-69)	Disable
Composite CC-A/B (page 4-69)	Disable
Composite TLC-39 (page 4-70)	Disable
UPC Composite Mode (page 4-70)	UPC Always Linked
Composite Beep Mode	Not Supported
UCC/EAN Code 128 Emulation Mode (page 4-70)	Disable
<b>2D Symbolologies</b>	
Aztec (page 4-71)	Enable
Aztec Inverse (page 4-72)	Regular Only
PDF417 (page 4-72)	Enable
MicroPDF417 (page 4-73)	Disable
Code 128 Emulation (page 4-73)	Disable
Data Matrix (page 4-74)	Enable
Data Matrix Inverse (page 4-74)	Regular Only
Maxicode (page 4-75)	Enable
MicroQR (page 4-75)	Enable
QR Code (page 4-76)	Enable
QR Inverse (page 4-76)	Regular Only
<b>Symbology-Specific Security Levels</b>	
Redundancy Level (page 4-77)	1
Security Level (page 4-79)	1

Ring Imager Setting 4400	Default
<a href="#">Intercharacter Gap Size</a> (page 4-80)	Normal
Macro PDF	Not Supported
Macro PDF Transmit/Decode Mode Symbols	Not Supported
Transmit Macro PDF Control Header	Not Supported
Escape Characters	Not Supported
Flush Macro PDF Buffer	Not Supported
Abort Macro PDF Entry	Not Supported
<a href="#">Redundancy Level</a> (page 4-77)	Level 1
<a href="#">Security Level</a> (page 4-79)	Level 1
<a href="#">Intercharacter Gap Size</a> (page 4-80)	Normal

## ***Set All Defaults/Cancel Bar Codes***

Use the Set All Defaults bar code to return all parameters to their default values. Scanning this bar code does not affect the mobile device's operating system, wireless client or installed software (e.g., AppLock) settings.

When the Parameter Scanning parameter is disabled, the scan engine can still scan the Set All Defaults bar code. Default value of Parameter Scanning is Enable.

When parameters are changed, the new value replaces the standard default value in memory.

Set All Defaults

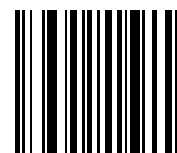

Cancel

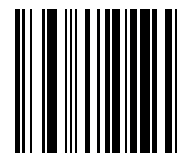

See [Pre-Configured Defaults](#) (page 4-1) for an alphabetical listing of all default values.

See Also: [Return to Factory Default Settings](#) (page 2-9).

---

## ***Enable / Disable Parameter Scanning***

Use this parameter to decide whether scanner parameters can be set using the bar codes in this chapter.

When this parameter is disabled, scan the Set All Defaults parameter bar code to enable parameter scanning.

When disabled, either scan the Enable Parameter Scans bar code or the Set All Defaults bar code to reset the parameter.

When enabled, scanners can be configured using the bar codes in this chapter.

Select a mode by scanning either of the bar codes shown below.

\* Enable Parameter Scans

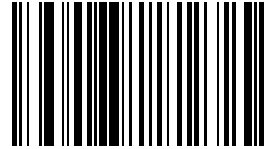

Disable Parameter Scans

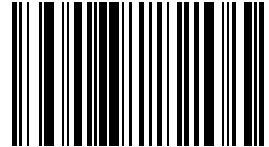

## ***Imager Parameters – General***

Except for the General imager attributes in this section that can be set by the end-user, imager programming attributes are set using the bar code wedge panel (Control Panel Scanner or Data Collection wedge panel) resident on the host mobile device. Bar code manipulation parameters assigned using the Bar Code Wedge panels are applied to the data resulting from successful bar code scans.

### ***Decode Session Timeout***

Default: 9.9 Seconds

This parameter sets the maximum time decode processing continues during a scan attempt. It is programmable in 0.1 second increments from 0.5 to 9.9 seconds. If a label has not been decoded before this time expires and the session is terminated, the software regards it as a failed scan attempt.

To begin setting a decode session time-out in seconds, scan this Decode Session Timeout bar code:

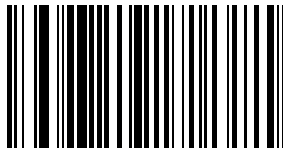

Next, scan two numeric bar codes that correspond to the desired time-out using [Imager Keypad Number Symbols](#) (page 4-81).

Times less than 1.0 second must have a leading zero.

If you wish to change your number selection, scan Cancel on the Imager Keypad Number Symbols page.



---

## **Decode Aiming Pattern**

Note: This parameter only applies when in Decode Mode. See [Operational Mode](#) (page 4-11)

Note: Scan *Enable Decode Aiming Pattern* to project the aiming pattern during bar code capture, or *Disable Decode Aiming Pattern* to turn the aiming pattern off.

\* Enable Decode Aiming Pattern

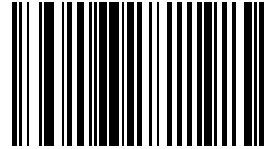

Disable Decode Aiming Pattern

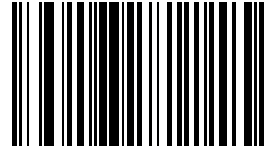

## **Decoding Autoexposure**

Select Enable Autoexposure to allow the imager to control gain settings and exposure (integration) time to best capture an image for the selected operation mode.

Select Disable Autoexposure to manually adjust the gain and exposure time (not supported in this version). This option is only recommended for advanced users with difficult image capture situations.

\* Enable Decoding Autoexposure

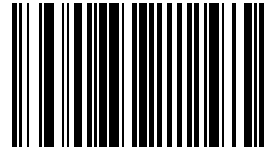

Disable Decoding Autoexposure

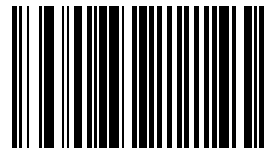

---

## **Decoding Illumination**

*Note: When this parameter is disabled, any LED Illumination parameter setting is ignored.*

*Note: The decoder has three small bright LEDs situated above the scan aperture.*

*Note: Enable this parameter for LED illumination upon every decode. The effectiveness of the illumination decreases as the distance to the target increases.*

Disable this parameter to prevent LED illumination.

See [LED Illumination](#) (page 4-10).

Select a setting by scanning one of the bar codes shown below.

\* Enable Illumination

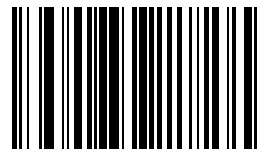

Disable Illumination

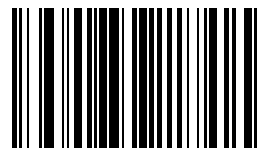

---

## ***Focus Mode***

Select a focus mode to control the working range of the imager.

When Far Focus is selected, the imager is optimized to read at its far position.

With Near Focus, the imager is optimized to read at its near position.

Smart Focus toggles the focus position after every frame. There may be audible signals from the ring imager as Smart Focus toggles after every frame.

Scan the appropriate bar code below.

\* Far Focus

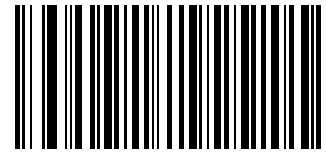

Near Focus

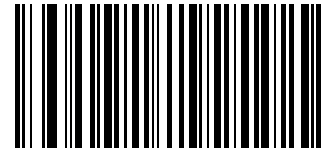

Smart Focus

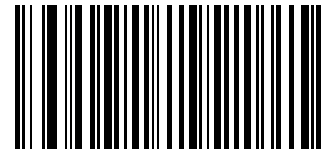

---

## LED Illumination

*Note: This parameter only applies for decoding if Decoding Illumination is enabled. If Decoding Illumination is disabled, all illumination is off for that mode, regardless of this LED Illumination setting.*

*Note: Default: PL4407: Internal Illumination MS4407: External Illumination*

The imager has three small bright LEDs situated above the scan aperture. Internal LED illumination turns the LEDs on during scan mode. The effectiveness of the illumination decreases as the distance to the target increases.

External illumination setting turns the LEDs off during scan mode.

Internal and External Illumination turns the LEDs on during scan mode.

See [Decoding Illumination](#) (page 4-8).

Select an illumination setting by scanning one of the bar codes shown below.

Internal Illumination



External Illumination

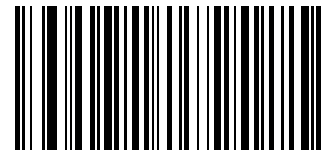

Internal and External Illumination

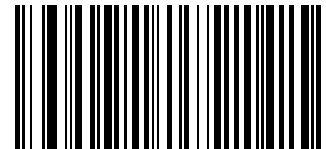

---

## **Operational Mode**

Default: Decode Mode

In **Decode Mode** (the default mode), and upon a Scan button event, the imager attempts to locate and decode enabled bar codes within its field of view.

The decoder remains in this mode as long as the Scan button is pressed or until a bar code is decoded.

Use Snapshot mode to capture a high quality image and transmit it to the host. While in this mode the decoder blinks the green LED at 1-second intervals to indicate it is not in standard operating (decode) mode.

In **Snapshot Mode**, the decoder turns on the laser aiming pattern to highlight the area to be captured in the image. The next trigger event instructs the decoder to capture a high quality image and transmit it to the host. A short time may pass (less than 2 seconds) between when the trigger is activated and the image is captured as the decoder adjusts to the lighting conditions.

Hold the imager steady until the image is captured, denoted by a single beep. If a trigger event is not activated within the Snapshot Mode Timeout period, the decoder returns to Decode Mode.

Use Snapshot Mode Timeout (not supported in this version) to adjust this timeout period. The default timeout period is 30 seconds.

To disable the laser aiming pattern during Snapshot Mode, see Snapshot Aiming Pattern (not supported in this version).

Use Video View Finder (not supported in this version) to enable Snapshot with Viewfinder Mode. In this mode the decoder behaves as a video camera until the trigger is active, at which time a Snapshot is performed as described above.

In Video mode the decoder behaves as a video camera as long as the trigger is active. When the trigger is released the imager returns to Decode Mode.

A Decode Mode bar code is not available. The default is as follows -- in other modes, when the scan button press or trigger is released the imager returns to Decode Mode.

Snapshot Mode

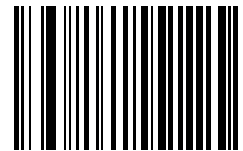

Video Mode

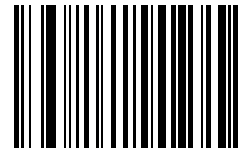

Cancel

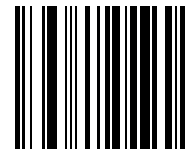

---

## Power Mode

*Note: Mobile devices are designed to be operated in Low Power Mode. For best results this value should remain unchanged.*

*Note: Default: PL4407: Low Power MS4407: Continuous On*

A parameter setting of Continuous On means the laser will not power down until the mobile device is powered off.

A parameter setting of Low Power means the laser will enter low power consumption mode after each decode attempt. Pressing the Scan button will begin another decode sequence.

See [Time Delay to Low Power Mode](#) (page 4-13).

Select a Power Mode by scanning either of the bar codes shown below.

Continuous On

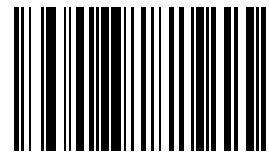

Low Power

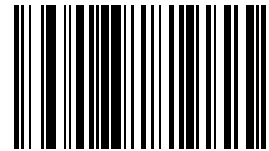

## Presentation Mode Session Timeout

This parameter, and the Presentation Mode parameter, are directed toward ring decoders that can scan a bar code that enters its field of view, determine a good read/bad read, then scan again.

This parameter determines how long the ring decoder will attempt to decode a bar code before determining if it is a good read or a bad read.

Presentation Mode means the ring decoder is always On and will scan bar codes that enter its field of view. Presentation Mode applies to Decode Mode only.

See also [Trigger Modes](#) (page 4-15).

Default: 2 Seconds

To set the duration of the attempt to decode a bar code detected in presentation mode, scan the Presentation Mode Session Timeout bar code below.



Next scan three numeric bar codes from [Imager Keypad Number Symbols](#) (page 4-81) to select a value between 1 and 255 that represents tenths of a second. Single digit numbers must have a leading zero.

For example, to set 0.5 seconds, scan the Presentation Mode Session Timeout bar code, then scan the 0, 0, 5 bar codes from the section titled Imager Keypad Number Symbols. To correct an error or change the selection, scan the Cancel bar code and try again.

---

### ***Time Delay to Low Power Mode***

This parameter sets the time the decoder remains active after decoding. The decoder wakes upon a Scan button press or when the host attempts to communicate with the decoder.

This parameter only applies when Power Mode is set to Low Power.

\* 1 Second Delay

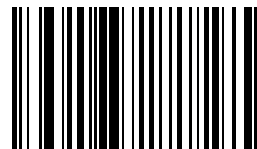

5 Second Delay

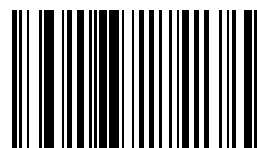

1 Minute Delay

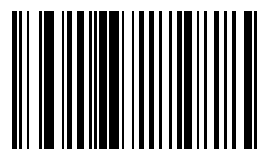

5 Minute Delay

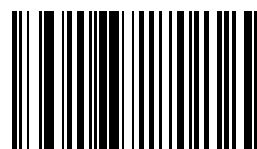

15 Minute Delay

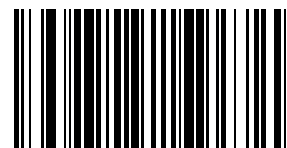

60 Minute Delay



---

### ***Time-out between Decodes, Same Symbol***

Parameter Default Value: 0.6 Seconds

This option is used in presentation mode to prevent multiple reads of a symbol left in the ring decoder's field of view. The timeout begins when the bar code is removed from the field of view. It is programmable in 0.1 second increments from 0.0 to 9.9 seconds.

To select the timeout between decodes for the same symbol, scan the following bar code, then scan two numeric bar codes from the [Imager Keypad Number Symbols](#) (page 4-81) at the end of this chapter that correspond to the desired interval, in 0.1 second increments.

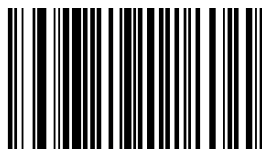

Times less than 1.0 second must have a leading zero.

If you wish to change your number selection, scan Cancel on the "Imager Keypad Number Symbols" page.



---

## Trigger Modes

*Note: Mobile devices with ring decoders are designed to be operated in Level Trigger Mode for best results the Trigger Mode default value should remain unchanged.*

Default: PL4407: Level Trigger Mode MS4407: Presentation Mode

Use this parameter to determine when the laser is activated and decoding begins, how long the laser remains on and what determines the cessation of the laser scan and decode process.

Select a trigger mode by scanning one of the bar codes that follow. If you wish to change your selection, scan Cancel.

**Level Trigger Mode** - A Scan button press activates the laser and decode processing. The laser remains on and decode processing continues until a Scan button release, a valid decode or the decode session time-out is reached.

**Presentation Trigger Mode** - When the ring scanner detects an object in its field of view it scans and attempts to decode. The range of object detection does not vary under normal lighting conditions. This applies to decode mode only. In Presentation Mode the unit does not enter its sleep state.

**Host Trigger Mode** - Triggering signal comes from a host command. Any actual Scan button press is interpreted by the scanner engine as a Level triggering option.

Level Trigger Mode

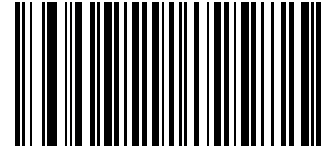

Presentation Trigger Mode

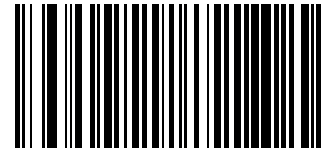

Host Trigger Mode

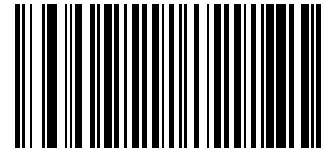

Cancel

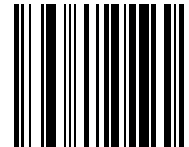

See also [Presentation Mode Session Timeout](#) (page 4-12).

---

## ***Report Version***

1. Connect the Ring Scanner module to a host device with a video display.
1. If necessary, open a text editor on the host device, make sure the cursor is in the open file, then scan this bar code with the ring imager.

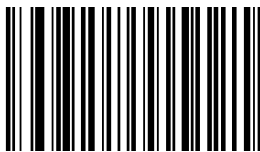

## ***Transmit Code ID Character***

Default: None

A code ID character identifies the code type of a scanned bar code. This may be useful when the imager is decoding more than one code type. In addition to any single character prefix already selected, the code ID character is inserted between the prefix and the decoded symbol.

Scan one of the following bar codes to select either no code ID character, a Symbol Code ID character or an AIM Code ID character.

### ***Transmit No Code ID Character***

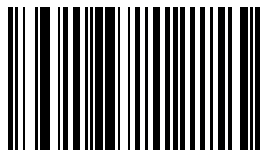

---

### ***Transmit Symbol Code ID Character***

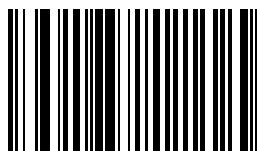

A	UPC-A, UPC-E, UPC-E1, EAN-8, EAN-13
B	Code 39, Code 32
C	Codabar
D	Code 128
E	Code 93
F	Interleaved 2 of 5
G	Discrete 2 of 5 or Discrete 2 of 5 IATA
H	Code 11
J	MSI Plessey
K	UCC/EAN-128
L	Bookland EAN
M	Trioptic Code 39
N	Coupon Code
R	RSS-14, RSS-Limited, RSS-Expanded
T	UCC Composite, TLC 39
X	PDF417, MacroPDF417, MicroPDF417
P00	Data Matrix
P01	QR Matrix
P02	Maxicode
P03	US Postnet
P04	US Planet
P05	Japan Postal
P06	UK Postal
P08	Dutch Postal
P09	Australian Postal
P09	UK Postal

## Transmit AIM Code ID Character

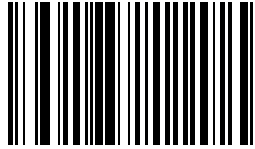

Each AIM Code Identifier contains the three character string ]cm where:

] = Flag Character (ASCII 93)

c = Code Character

A	Code 39, Code 39 Full ASCII, Code 32
C	Code 128, Coupon (Code 128 portion)
d	Data Matrix
E	UPC/EAN, Coupon (UPC portion)
e	RSS Family
F	Codabar
G	Code 93
H	Code 11
I	Interleaved 2 of 5
L	PDF417, Macro PDF417, Micro PDF417
M	MSI (Plessey)
Q	QR Code
S	Discrete 2 of 5, IATA 2 of 5
U	Maxicode
X	Code 39 Trioptic, Bookland EAN, US Postnet, US Planet, UK Postal, Japan Postal, Australian Postal, Dutch Postal

m = Modifier Character

The modifier character is the sum of the applicable option values based on the following table.

Code Type	Option Value	Option
<b>Code39</b>		
	0	No Check character or Full ASCII processing.
	1	Reader has checked one check character.
	3	Reader has checked and stripped check character.
	4	Reader has performed Full ASCII character conversion.
	5	Reader has performed Full ASCII character conversion and checked one check character.
	7	Reader has performed Full ASCII character conversion and checked and stripped check character.
		Example: A Full ASCII bar code with check character W,A+I+MI+DW, is transmitted as ]A7Aimld where 7 = (3+4).
<b>Trioptic Code 39</b>		
	0	No option specified at this time. Always transmit 0.
		Example: A Trioptic bar code 412356 is transmitted as ]X0412356

Code Type	Option Value	Option
<b>Code 128</b>		
	0	Standard data packet, No Function code 1 in first symbol position.
	1	Function code 1 in first symbol character position.
	2	Function code 1 in second symbol character position.
		Example: A Code (EAN) 128 bar code with Function 1 character in the first position, <sup>FNC1</sup> Aim Id is transmitted as ]CIAimld
<b>I 2 of 5</b>		
	0	No check digit processing.
	1	Reader has validated check digit.
	3	Reader has validated and stripped check digit .
		Example: An I 2 of 5 bar code without check digit, 4123, is transmitted as ]I04123
<b>Codabar</b>		
	0	No check digit processing.
	1	Reader has checked check digit.
	3	Reader has stripped check digit before transmission.
		Example: A Codabar bar code without check digit, 4123, is transmitted as ]F04123
<b>Code 93</b>		
	0	No options specified at this time. Always transmit 0.
		Example: A Code 93 bar code 012345678905 is transmitted as ]G0012345678905
<b>MSI Plessey</b>		
	0	Single check digit checked.
	1	Two check digits checked.
	2	Single check digit verified and stripped before transmission.
	3	Two check digits verified and stripped before transmission.
		Example: An MSI Plessey bar code 4123, with a single check digit checked, is transmitted as ]M04123
<b>D 2 of 5</b>		
	0	No options specified at this time. Always transmit 0.
		Example: A D 2 of 5 bar code 4123, is transmitted as ]S04123
<b>UPC/EAN</b>		
	0	Standard packet in full EAN country code format, which is 13 digits for UPC-A and UPC-E (not including supplemental data).
	1	Two digit supplement data only
	2	Five digit supplement data only
	4	EAN-8 data packet.
		Example: A UPC-A bar code 012345678905 is transmitted as ]E00012345678905
<b>Bookland EAN</b>		
	0	No options specified at this time. Always transmit 0.
		Example: A Bookland EAN bar code 123456789X is transmitted as ]X0123456789X
<b>Code 11</b>		
	0	Single check digit.
	1	Two check digits.
	3	Check characters validated but not transmitted.

Code Type	Option Value	Option
<b>RSS Family</b>		
		No option specified at this time. Always transmit 0. RSS-14 and RSS-Limited transmit with an Application Identifier "01". Note: In UCC/EAN-128 emulation mode, RSS is transmitted using Code 128 rules (i.e., ]C1).
		Example: An RSS-14 bar code 100123456788902 is transmitted as ]e001100123456788902.
<b>EAN.UCC Composites (RSS, UCC/EAN-128, 2D portion of UPC composite)</b>		
		Native mode transmission. Note: UPC portion of composite is transmitted using UPC rules.
	0	Standard data packet.
	1	Data packet containing the data following an encoded symbol separator character.
	2	Data packet containing the data following an escape mechanism character. The data packet does not support the ECI protocol.
	3	Data packet containing the data following an escape mechanism character. The data packet supports the ECI protocol.
	-	UCC/EAN-128 emulation Note: UPC portion of composite is transmitted using UPC rules.
	1	Data packet is a UCC/EAN-128 symbol (i.e., data is preceded with ]JC1).
<b>PDF417, Micro PDF417</b>		
	0	Reader set to conform to protocol defined in 1994 PDF417 symbology specifications. Note: When this option is transmitted, the receiver cannot reliably determine whether ECIs have been invoked or whether data byte 92DEC has been doubled in transmission.
	1	Reader set to follow the ECI protocol (Extended Channel Interpretation). All data characters 92DEC are doubled.
	2	Reader set for Basic Channel operation (no escape character transmission protocol). Data characters 92DEC are not doubled. Note: When decoders are set to this mode, unbuffered Macro symbols and symbols requiring the decoder to convey ECI escape sequences cannot be transmitted.
	3	The bar code contains a UCC/EAN-128 symbol, and the first codeword is 903-907, 912, 914, 915.
	4	The bar code contains a UCC/EAN-128 symbol, and the first codeword is in the range 908-909.
	5	The bar code contains a UCC/EAN-128 symbol, and the first codeword is in the range 910-911.
		Example: A PDF417 bar code ABCD, with no transmission protocol enabled, is transmitted as ]L2ABCD.
<b>Data Matrix</b>		
	0	ECC 000-140, not supported.
	1	ECC 200.
	2	ECC 200, FNC1 in first or fifth position.
	3	ECC 200, FNC1 in second or sixth position.
	4	ECC 200, ECI protocol implemented.
	5	ECC 200, FNC1 in first or fifth position, ECI protocol implemented.
	6	ECC 200, FNC1 in second or sixth position, ECI protocol implemented.
<b>MaxiCode</b>		
	0	Symbol in Mode 4 or 5.
	1	Symbol in Mode 2 or 3.
	2	Symbol in Mode 4 or 5, ECI protocol implemented.
	3	Symbol in Mode 2 or 3, ECI protocol implemented in secondary message.

Code Type	Option Value	Option
<b>QR Code</b>		
	0	Model 1 symbol.
	1	Model 2 symbol, ECI protocol not implemented.
	2	Model 2 symbol, ECI protocol implemented.
	3	Model 2 symbol, ECI protocol not implemented, FNC1 implied in first position.
	4	Model 2 symbol, ECI protocol implemented, FNC1 implied in first position.
	5	Model 2 symbol, ECI protocol not implemented, FNC1 implied in second position.
	6	Model 2 symbol, ECI protocol implemented, FNC1 implied in second position.

According to AIM standards, a UPC with supplemental bar code is transmitted in the following format:

]EO (UPC chars) (terminator) ]E2 (supplemental) (terminator)

Therefore, a UPC with two supplemental characters, 01234567890510, is transmitted to the host as a 21-character string, ]E00012345678905]E110.

---

## Prefix / Suffix Values

Ring decoder engine prefix and suffix parameters should not be set, changed, or reset using the Prefix and Suffix bar codes shown in this section. When the Ring Scanner Module is reset to defaults, the prefix and suffix settings revert to their default values and need to be scanned again. Use the ScanWedge NGW Power Tool (Dolphin 70e) or Scanner control panel (HX2 or HX3) in the host computer to store prefix and suffix values.

See previous section titled [Prefix / Suffix](#) (page 4-1) for an explanation.

Prefix (P) Default: Null

Suffix1 (S1) Default: LF

Suffix2 (S2) Default: CR

*Note: Parameter "Scan Data Transmission Format" must be set before selecting Prefix/Suffix values.*

*Note: A prefix and/or one or two suffixes may be appended to scan data for use in data editing. These values are set by scanning four bar codes (resulting in a four digit number) that correspond to key codes for various mobile devices.*

*Note: See the table titled [ASCII Character Equivalents](#) (page 6-1) for keycodes.*

*Note: Prefix*

To begin setting Prefix values for SSI hosts first set the Scan Data Transmission Format, then scan this Scan Prefix bar code:

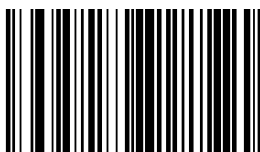

Next, scan four numeric bar codes that correspond to the computer key code using [Imager Keypad Number Symbols](#) (page 4-81) at the end of this chapter.

If you wish to change your selection, scan Cancel on the Imager Keypad Number Symbols page.

### **Suffix 1**

To begin setting Suffix 1 value, scan this Scan Suffix 1 bar code:

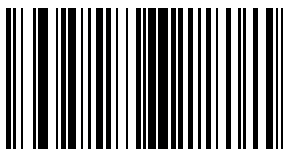

Next, scan four numeric bar codes that correspond to the computer keycode using the [Imager Keypad Number Symbols](#) (page 4-81).

If you wish to change your selection, scan Cancel on the "Imager Keypad Number Symbols" page.

### **Suffix 2**

To begin setting Suffix 2 value, scan this Scan Suffix 2 bar code:

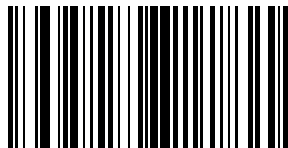

Next, scan four numeric bar codes that correspond to the computer keycode using the [Imager Keypad Number Symbols](#) (page 4-81).

If you wish to change your numeric selection, scan Cancel on the "Imager Keypad Number Symbols" page.



---

## Scan Data Transmission Format

*Note: Parameter Prefix/Suffix Values for SSI hosts should be set after setting this parameter.*

*Note: Ring decoder engine prefix and suffix parameters should not be set, changed, or reset using the Prefix and Suffix bar codes shown in this section. When the Ring Scanner Module is reset to defaults, the prefix and suffix settings revert to their default values and need to be scanned again. Use the ScanWedge NGW Power Tool (Dolphin 70e) or Scanner control panel (HX2 or HX3) in the host computer to store prefix and suffix values.*

*Note: Use this option when you want to append a prefix and suffix to the SSI host decode data. If you wish to change your selection, scan the Cancel bar code and scan again.*

Set the Scan Data Transmission Format parameter by scanning one of the following bar codes:

\* Data As Is

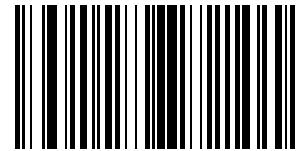

[Data] [Suffix 1]

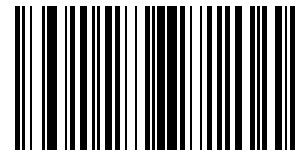

[Data] [Suffix 2]

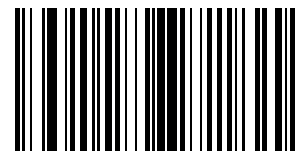

[Data] [Suffix 1] [Suffix 2]

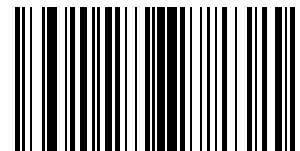

[Prefix] [Data]

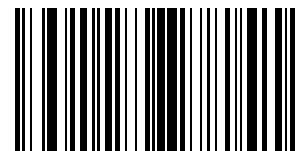

---

[Prefix] [Data] [Suffix 1]

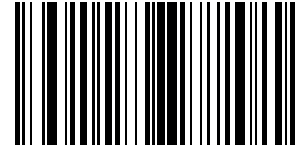

[Prefix] [Data] [Suffix 2]

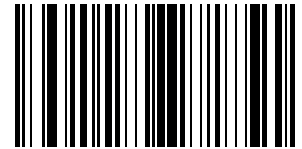

[Prefix] [Data] [Suffix 1] [Suffix 2]

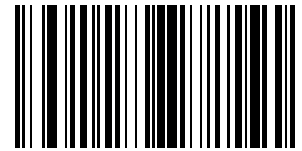

Cancel

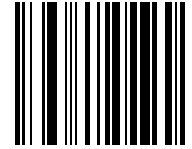

---

### ***Transmit “No Read” Message***

Scan a bar code below to select whether or not to transmit a No Read message.

When enabled, the characters NR are transmitted when a bar code is not decoded. When disabled, if a symbol does not decode, nothing is sent to the host.

Enable Transmit No Read

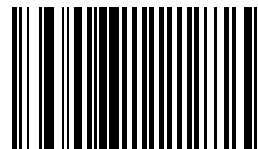

\* Disable Transmit No Read

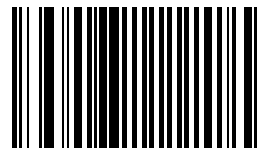

---

## **UPC/EAN**

### **UPC-A**

Select an option by scanning either of the bar codes shown below.

\* Enable UPC-A

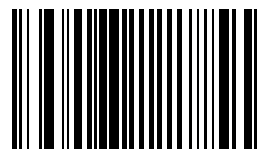

Disable UPC-A

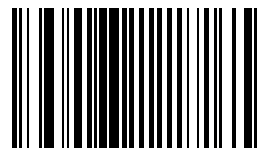

### **UPC-E**

Select an option by scanning either of the bar codes shown below.

\* Enable UPC-E

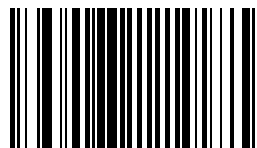

Disable UPC-E

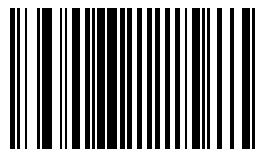

---

## **UPC-E1**

Select an option by scanning either of the bar codes shown below.

Enable UPC-E1

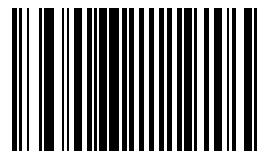

\* Disable UPC-E1

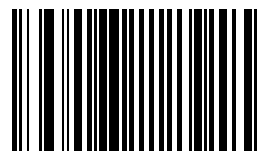

*Note: UPC-E1 is not a UCC (Uniform Code Council) approved symbology.*

## **EAN-8/JAN-8**

Select an option by scanning either of the bar codes shown below.

\* Enable EAN-8/JAN-8

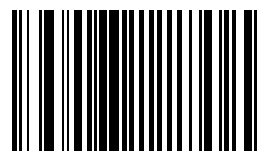

Disable EAN-8/JAN-8

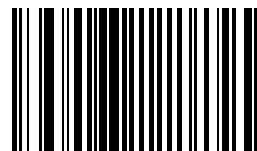

---

***EAN-13/JAN-13***

Select an option by scanning either of the bar codes shown below.

\* Enable EAN-13/JAN-13

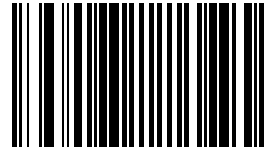

Disable EAN-13/JAN-13

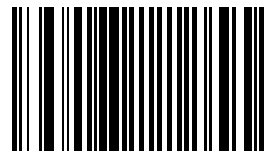

***Bookland EAN***

Select an option by scanning either of the bar codes shown below.

Enable Bookland EAN

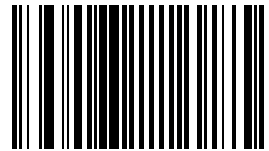

\* Disable Bookland EAN

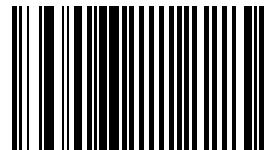

---

## Bookland Format

This parameter is used to control the Bookland Format. Select an option by scanning either of the bar codes shown below.

\* Bookland 10

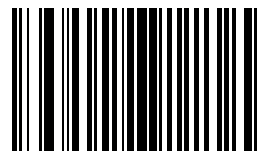

Bookland 13

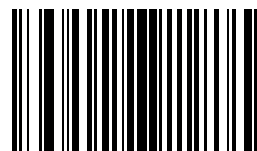

## Decode UPC/EAN/JAN Supplementals (2 and 5 digits)

Supplementals are bar codes appended according to specific format conventions (e.g., UPC A+2, UPC E+2, EAN 13+2). Six options are available:

Selecting:

Option	Result
Decode UPC/EAN/JAN with Supplementals	UPC/EAN/JAN symbols without supplemental characters are not decoded.
Ignore Supplementals	The UPC/EAN/JAN symbol is decoded and the supplemental bar code is ignored.
Autodiscriminate UPC/EAN/JAN Supplementals	When this option is selected you must assign a value to the "Decode UPC/EAN Supplemental Redundancy" parameter. A value of 5 or more is recommended.
Enable 378/379 Supplemental Mode	The scanner will identify supplementals for EAN-13/JAN-13 bar codes that start with a 378 or 379 prefix only. All other UPC/EAN/JAN codes are decoded immediately and the supplemental characters ignored.
Enable 978 Supplemental Mode	The scanner will identify supplementals for EAN-13/JAN-13 bar codes that start with a 978 prefix only. All other UPC/EAN/JAN codes are decoded immediately and the supplemental characters ignored.
Enable Smart Supplemental Mode	The scanner will identify supplementals for EAN-13/JAN-13 bar codes that start with a 378, 379 or 978 prefix only. All other UPC/EAN/JAN bar codes are decoded immediately and the supplemental characters ignored.

*Note: In order to minimize the risk of invalid data transmission, select whether to read or ignore supplemental characters.*

*Note: Select an option by scanning one of the bar codes shown below. If you wish to change your selection, scan the Cancel bar code and scan again.*

---

Decode UPC/EAN/JAN only with Supplementals

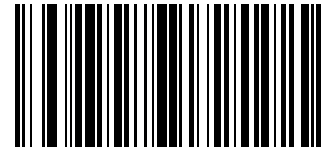

\* Ignore Supplementals

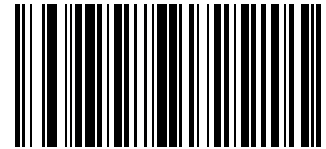

Autodiscriminate UPC/EAN/JAN Supplementals

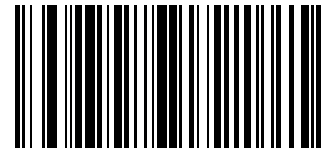

Enable 378/379 Supplemental Mode

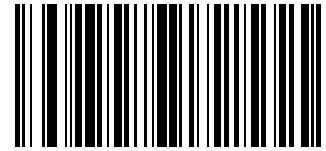

Enable 978 Supplemental Mode



Enable Smart Supplemental Mode

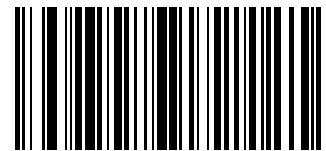

Cancel

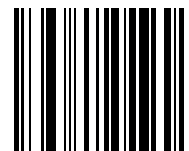



---

## **UPC/EAN/JAN Supplemental Redundancy**

Default: 10 Times

With Autodiscriminate UPC/EAN Supplementals selected, this option adjusts the number of times a symbol without supplementals is decoded before transmission. The range is from 2 to 30 times. Five or above is recommended when decoding a mix of UPC/EAN/JAN symbols with and without supplementals, and the autodiscriminate option is selected.

To begin setting the decode redundancy value, scan this bar code:

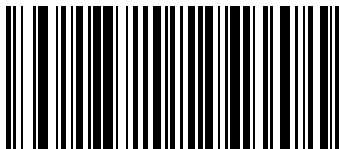

Next, scan two numeric bar codes that correspond to the desired value using the [Imager Keypad Number Symbols](#) (page 4-81). Single digit numbers must have a leading zero.

To correct an error or change a selection, scan Cancel on the Imager Keypad Number Symbols page.

### **Transmit UPC-A Check Digit**

This parameter determines whether the symbol will be transmitted with or without the UPC-A check digit.

Select an option by scanning either of the bar codes shown below.

\* Enable Transmit UPC-A Check Digit

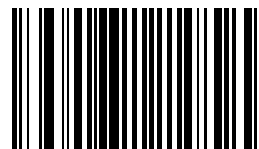

Disable Transmit UPC-A Check Digit

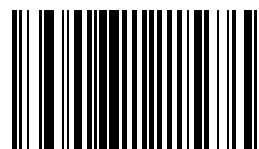

---

### ***Transmit UPC-E Check Digit***

This parameter determines whether the symbol will be transmitted with or without the UPC-E check digit.  
Select an option by scanning either of the bar codes shown below.

\* Enable Transmit UPC-E Check Digit

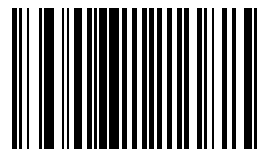

Disable Transmit UPC-E Check Digit

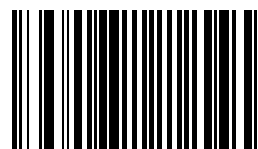

### ***Transmit UPC-E1 Check Digit***

This parameter determines whether the symbol will be transmitted with or without the UPC-E1 check digit.  
Select an option by scanning either of the bar codes shown below.

\* Enable Transmit UPC-E1 Check Digit

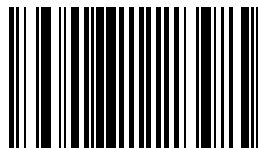

Disable Transmit UPC-E1 Check Digit

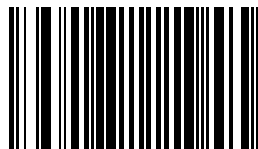

---

## UPC-A Preamble

A preamble is a lead-in character for UPC-A symbols transmitted to the host device. The lead-in characters are considered part of the symbol.

Data is sent to the host in the following format:

No Preamble	[data]
System Character	[schar] [data]
System Character and Country Code	[country code] [schar] [data]

Select an option by scanning one of the bar codes shown below.

No Preamble

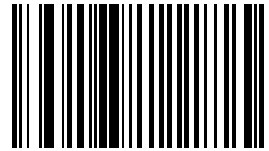

\* System Character

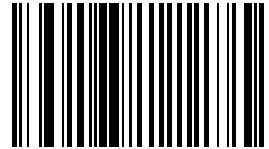

System Character and Country Code  
("0" for USA)

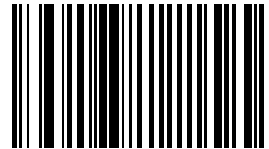

---

### **UPC-E Preamble**

A preamble is a lead-in character for UPC-E symbols transmitted to the host device. The lead-in characters are considered part of the symbol.

Data is sent to the host in the following format:

No Preamble	[data]
System Character	[schar] [data]
System Character and Country Code	[country code] [schar] [data]

Select an option by scanning one of the bar codes shown below.

No Preamble

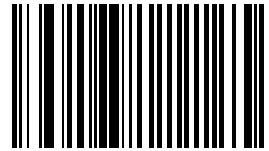

\* System Character

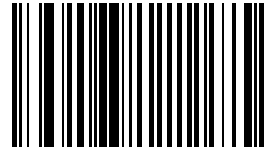

System Character and Country Code  
("0" for USA)

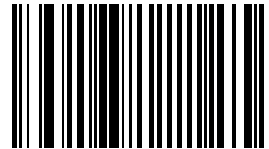

---

## UPC-E1 Preamble

A preamble is a lead-in character for UPC-E1 symbols transmitted to the host device. The lead-in characters are considered part of the symbol.

Data is sent to the host in the following format:

No Preamble	[data]
System Character	[schar] [data]
System Character and Country Code	[country code] [schar] [data]

Select an option by scanning one of the bar codes shown below.

No Preamble

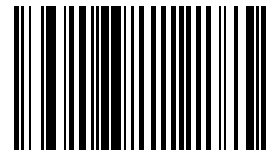

\* System Character

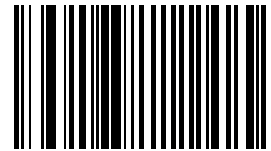

System Character and Country Code  
("0" for USA)

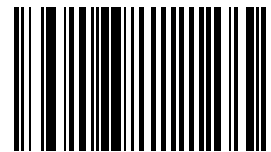

---

### ***Convert UPC-E to UPC-A***

When this parameter is enabled, UPC-E (zero suppressed) decoded data is converted to UPC-A format before transmission. After conversion, data follows UPC-A format and is affected by UPC-A programming selections (e.g., Preamble, Check Digit, etc.).

When disabled, UPC-E (zero suppressed) decoded data is transmitted without conversion.

Select an option by scanning either of the bar codes shown below.

Enable UPC-E to UPC-A

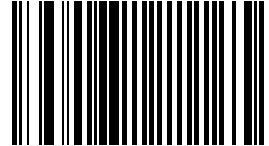

\* Disable UPC-E to UPC-A

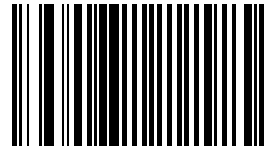

### ***Convert UPC-E1 to UPC-A***

When this parameter is enabled, UPC-E1 (zero suppressed) decoded data is converted to UPC-A format before transmission. After conversion, data follows UPC-A format and is affected by UPC-A programming selections (e.g., Preamble, Check Digit, etc.).

When disabled, UPC-E1 (zero suppressed) decoded data is transmitted without conversion.

Select an option by scanning either of the bar codes shown below.

Enable Convert UPC-E1 to UPC-A

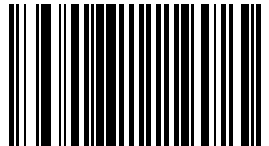

\* Disable Convert UPC-E1 to UPC-A

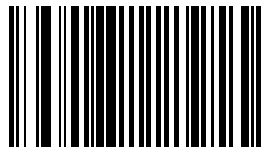

---

### ***EAN-8/JAN-8 Extend***

When this parameter is enabled, five leading zeros are added to decoded EAN-8 symbols to make them compatible in format to EAN-13 symbols. Use parameter “Convert EAN-8 to EAN-13 Type” to label the extended symbol.

When disabled, EAN-8 symbols are transmitted as is and parameter “Convert EAN-8 to EAN-13 Type” setting is ignored. Select an option by scanning either of the bar codes shown below.

Enable EAN-8/JAN-8 Zero Extend

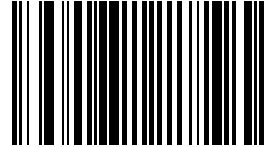

\* Disable EAN-8/JAN-8 Zero Extend

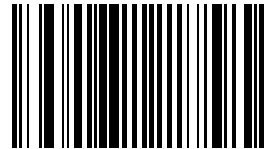

### ***UCC Coupon Extended Code***

*Note: UCC Coupon Extended Code replaces UPC/EAN Coupon Code.*

The UCC Coupon Extended Code is an additional bar code adjacent to a UCC Coupon Code. To enable or disable UCC Coupon Extended Code, scan the appropriate bar code below.

When enabled, this parameter decodes UPC-A bar codes starting with digit “5”, EAN-13 bar codes starting with digit “99” and UPC-A/EAN-128 Coupon Codes.

UPCA, EAN-13 and EAN-128 must be enabled to scan all types of Coupon Codes.

Enable UCC Coupon Extended Code

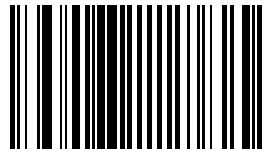

\* Disable UCC Coupon Extended Code

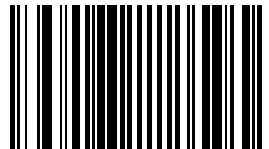

*Note: Use the Decode UPC/EAN Supplemental Redundancy parameter to control autodiscrimination of the EAN128 (right half) of a coupon code.*

---

## **Code 128**

Set this parameter by scanning either of the bar codes shown below.

\* Enable Code 128

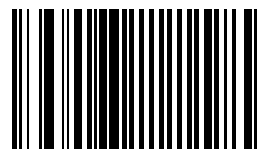

Disable Code 128

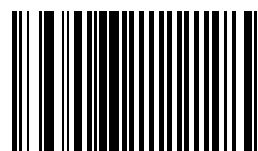

## **UCC/EAN-128**

Set this parameter by scanning either of the bar codes shown below.

\* Enable UCC/EAN-128

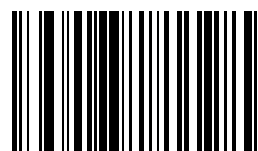

Disable UCC/EAN-128

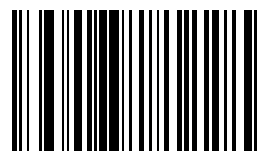



---

## **ISBT-128**

ISBT-128 is a variant of Code 128 used in the blood bank industry. If necessary, the host must perform concatenation of the ISBT data.

Set this parameter by scanning either of the bar codes shown below.

\* Enable ISBT-128

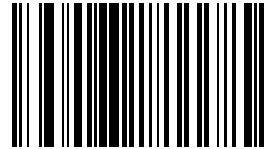

Disable ISBT-128

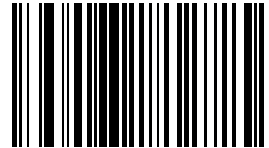

## **Code 39**

*Note: This parameter must be enabled when "Convert Code 39 to Code 32" is to be enabled.*

*Note: Set this parameter by scanning either of the bar codes shown below.*

\* Enable Code 39

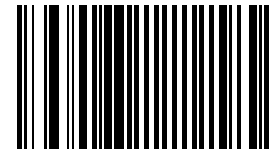

Disable Code 39

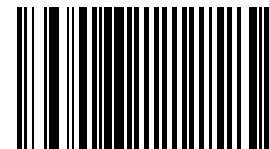

---

## ***Trioptic Code 39***

Trioptic Code 39 symbols always contain six characters.

When Trioptic Code 39 is enabled, set the Code 39 Full ASCII parameter to disabled. Both parameters should not be enabled simultaneously.

Set this parameter by scanning either of the bar codes shown below.

Enable Trioptic Code 39

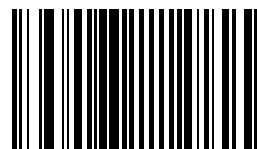

\* Disable Trioptic Code 39

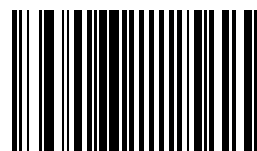

## ***Convert Code 39 to Code 32***

*Note: Code 39 must be enabled in order for this parameter to function.*

*Note: When parameter Code 32 Prefix is to be enabled, this Convert Code 39 to Code 32 (Italian Pharmacy Code) parameter must also be enabled.*

*Note: Set this parameter by scanning either of the bar codes shown below.*

Enable Convert Code 39 to Code 32

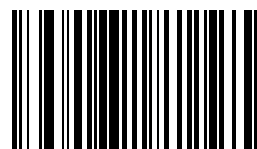

\* Disable Convert Code 39 to Code 32

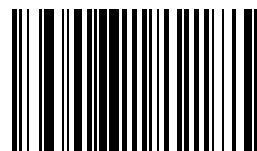

---

### **Code 32 Prefix**

This parameter adds the prefix character “A” to all Code 32 bar codes.

*Note: When enabled, Convert Code 39 to Code 32 parameter must also be enabled.*

Set this parameter by scanning either of the bar codes shown below.

Enable Code 32 Prefix

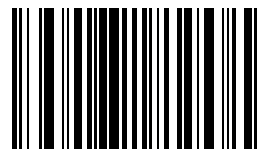

\* Disable Code 32 Prefix

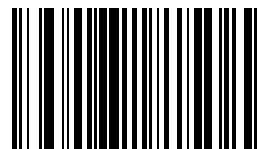

---

## **Set Length(s) for Code 39**

L1 Default: 2

L2 Default: 55

Lengths for Code 39 may be set for:

- any length,
- one or two discrete lengths,
- or lengths within a specific range.

The length of a code refers to the number of characters, including check digits, the code contains. If Code 39 Full ASCII is enabled, Length Within a Range or Any Length are the preferred options.

See the table titled [ASCII Character Equivalents](#) (page 6-1).

### **One Discrete Length (Parameter L1)**

This option decodes only those codes containing a selected length. For example, when you want to scan only Code 39 symbols containing 14 characters, scan the following bar code and then “1” and “4” bar codes using the [Imager Keypad Number Symbols](#) (page 4-81). Single digits must be preceded by a zero.

To begin setting one discrete length, scan this One Discrete Length bar code:

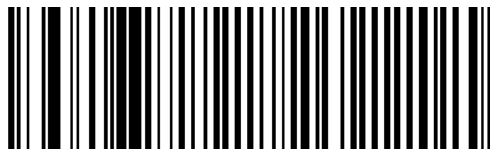

Next, scan two numeric bar codes that correspond to the desired value. Single digit numbers must have a leading zero. To correct an error or to change a selection, scan Cancel on the Imager Keypad Number Symbols page.

### **Two Discrete Lengths (Parameter L2)**

This option decodes only those codes containing two selected lengths. For example, when you want to scan only Code 39 symbols containing 2 or 14 characters, scan the following bar code and then “0”, “2”, “1” and “4” bar codes using the [Imager Keypad Number Symbols](#) (page 4-81).

To begin setting two discrete lengths, scan this Two Discrete Lengths bar code:



Next, scan four numeric bar codes that correspond to the desired value. Single digit numbers must have a leading zero. To correct an error or to change a selection, scan Cancel on the Imager Keypad Number Symbols page.

### **Length Within Range**

This option decodes a code type within a specified minimum and maximum range. For example, when you want to scan only Code 39 symbols containing between 4 and 12 characters, scan the “Code 39 Length Within Range” bar code and then “0”, “4”, “1” and “2” bar codes using the [Imager Keypad Number Symbols](#) (page 4-81).

To begin setting lengths within a range, scan this Length Within Range bar code:



Next, scan numeric bar codes that correspond to the desired value. Single digit numbers must have a leading zero. To correct an error or to change a selection, scan Cancel on the Imager Keypad Number Symbols page.

---

### ***Any Length***

This option decodes Code 39 bar codes containing any number of characters.

To set any length, scan this Any Length bar code:

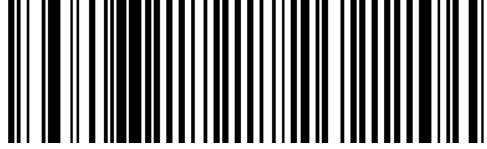

### ***Code 39 Check Digit Verification***

When enabled, this parameter checks the integrity of a Code 39 symbol to ensure it complies with specified check digit algorithms.

Only Code 39 symbols which include a Modulo 43 check digit are decoded when this parameter is enabled.

When Transmit Code 39 Check Digit is enabled, this parameter must be enabled too.

Enable this feature if the code 39 bar codes contain a Modulo 43 check digit.

Set this parameter by scanning either of the bar codes shown below.

Enable Code 39 Check Digit Verification

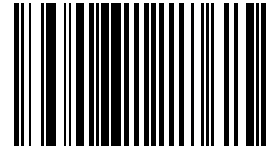

\* Disable Code 39 Check Digit Verification

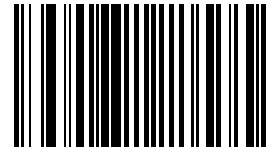

---

### **Transmit Code 39 Check Digit**

When enabled, the check digit is transmitted with the data.

Code 39 Check Digit Verification must be enabled for this parameter to function.

Set this parameter by scanning either of the bar codes shown below.

Enable Transmit Code 39 Check Digit

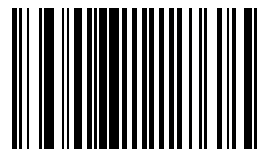

\* Disable Transmit Code 39 Check Digit

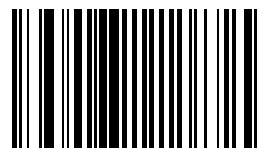

### **Code 39 Full ASCII Conversion**

*Note: Code 39 Full ASCII and Trioptic Code 39 should not be enabled simultaneously.*

Code 39 Full ASCII is a variant of Code 39 which pairs characters to encode the full ASCII character set.

Set this parameter by scanning either of the bar codes shown below.

Enable Code 39 Full ASCII Conversion

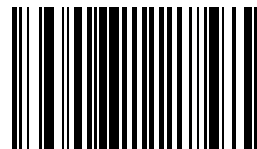

\* Disable Code 39 Full ASCII Conversion

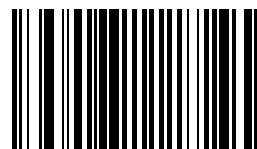

When enabled, the ASCII character set assigns a code to letters, punctuation marks, numerals, and most control key-strokes on the keyboard.

The first 32 codes are non-printable and are assigned to keyboard control characters such as [Backspace] and [Return or Enter]. The other 96 are called printable codes because all but [Space] and [Delete] produce visible characters.

Code 39 Full ASCII interprets the bar code special character (\$ + % /) preceding a Code 39 character and assigns an ASCII character value to the pair.

See the table titled [ASCII Character Equivalents](#) (page 6-1).

---

## Code 93

Default:

Disable Code 93

- L1 Default : 4
- L2 Default: 55

When enabled, Code 93 symbols will be scanned, decoded and transmitted.

Set this parameter by scanning either of the bar codes shown below.

Enable Code 93

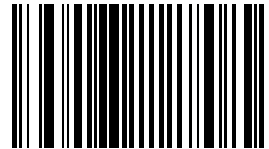

\* Disable Code 93

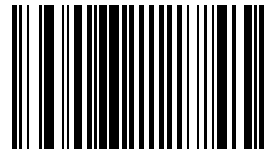

### Set Lengths for Code 93

L1 Default: 4 L2 Default: 55

Lengths for Code 93 may be set for:

- any length,
- one or two discrete lengths,
- or lengths within a specific range.

The length of a code refers to the number of characters, including check digits, the code contains.

See the table titled [ASCII Character Equivalents](#) (page 6-1).

#### **One Discrete Length (Parameter L1)**

This option decodes only those codes containing a selected length. For example, when you want to scan only Code 93 symbols containing 14 characters, scan the "Code 93 One Discrete Length" bar code and then "1" and "4" bar codes using the [Imager Keypad Number Symbols](#) (page 4-81).

To begin setting one discrete length, scan this Code 93 One Discrete Length bar code:

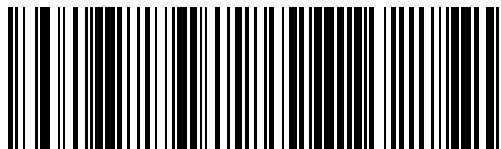

Next, scan two numeric bar codes that correspond to the desired value. Single digit numbers must have a leading zero. To correct an error or to change a selection, scan Cancel on the "Imager Keypad Number Symbols" page.

---

### ***Two Discrete Lengths (Parameter L2)***

This option decodes only those codes containing two selected lengths. For example, when you want to scan only Code 93 symbols containing 2 or 14 characters, scan the “Code 93 Two Discrete Lengths” bar code and then “0”, “2”, “1” and “4” bar codes using the [Imager Keypad Number Symbols](#) (page 4-81).

To begin setting two discrete lengths, scan this Code 93 Two Discrete Lengths bar code:

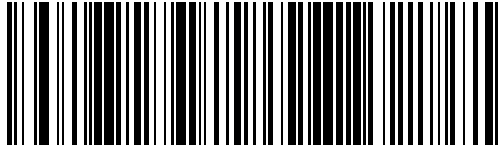

Next, scan four numeric bar codes that correspond to the desired value. Single digit numbers must have a leading zero. To correct an error or to change a selection, scan Cancel on the “Imager Keypad Number Symbols” page.

### ***Length Within Range***

This option decodes a code type within a specified minimum and maximum range. For example, when you want to scan only Code 93 symbols containing between 4 and 12 characters, scan the “Code 93 Length Within Range” bar code and then “0”, “4”, “1” and “2” bar codes using the [Imager Keypad Number Symbols](#) (page 4-81).

To begin setting lengths within a range, scan this Code 93 Length Within Range bar code:

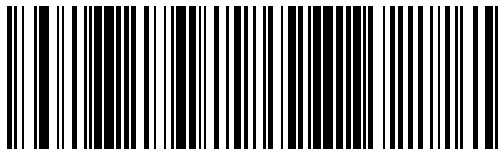

Next, scan numeric bar codes that correspond to the desired value. Single digit numbers must have a leading zero. To correct an error or to change a selection, scan Cancel on the “Imager Keypad Number Symbols” page.

### ***Any Length***

This option decodes Code 93 bar codes containing any number of characters.

To set any length, scan this Code 93 Any Length bar code:

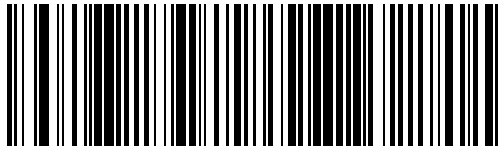



---

## Code 11

When enabled, Code 11 symbols will be scanned, decoded and transmitted.  
Set this parameter by scanning either of the bar codes shown below.

Enable Code 11

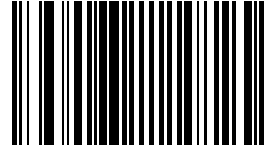

\* Disable Code 11

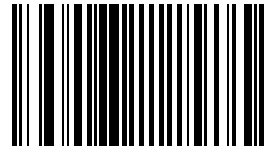

### **Set Lengths for Code 11**

L1 Default: 4 L2 Default: 55

Lengths for Code 11 may be set for:

- any length,
- one or two discrete lengths,
- or lengths within a specific range.

The length of a code refers to the number of characters, including check digits, the code contains. It also includes any start or stop characters.

See the table titled [ASCII Character Equivalents](#) (page 6-1).

#### **One Discrete Length (Parameter L1)**

This option decodes only those codes containing a selected length. For example, when you want to scan only Code 11 symbols containing 14 characters, scan the “Code 11 One Discrete Length” bar code and then “1” and “4” bar codes using the [Imager Keypad Number Symbols](#) (page 4-81).

To begin setting one discrete length, scan this Code 11 One Discrete Length bar code:

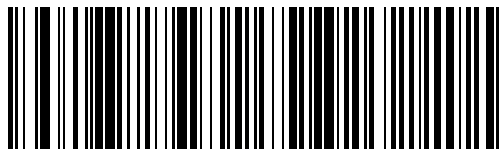

Next, scan two numeric bar codes that correspond to the desired value. Single digit numbers must have a leading zero. To correct an error or to change a selection, scan Cancel on the “Imager Keypad Number Symbols” page.

---

### ***Two Discrete Lengths (Parameter L2)***

This option decodes only those codes containing two selected lengths. For example, when you want to scan only Code 11 symbols containing 2 or 14 characters, scan the Code 11 Two Discrete Lengths bar code and then “0”, “2”, “1” and “4” bar codes using the Imager Keypad Number Symbols.

To begin setting two discrete lengths, scan this Code 11 Two Discrete Lengths bar code:

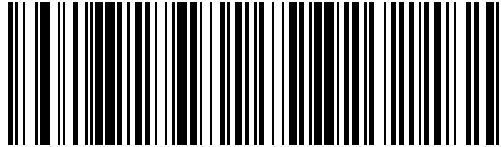

Next, scan four numeric bar codes that correspond to the desired value. Single digit numbers must have a leading zero. To correct an error or to change a selection, scan Cancel on the [Imager Keypad Number Symbols](#) (page 4-81).

### ***Length Within Range***

This option decodes a code type within a specified minimum and maximum range. For example, when you want to scan only Code 11 symbols containing between 4 and 12 characters, scan the “Code 11 Length Within Range” bar code and then “0”, “4”, “1” and “2” bar codes.

To begin setting lengths within a range, scan this Code 11 Length Within Range bar code:

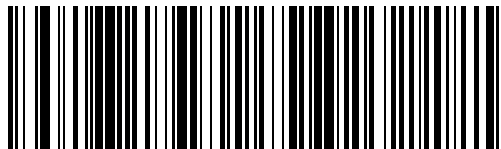

Next, scan numeric bar codes that correspond to the desired value using the Imager Keypad Number Symbols. Single digit numbers must have a leading zero. To correct an error or to change a selection, scan Cancel on the “Imager Keypad Number Symbols” page.

### ***Any Length***

This option decodes Code 11 bar codes containing any number of characters.

To set any length, scan this Code 11 Any Length bar code:

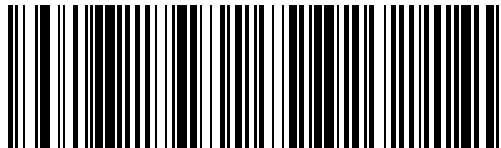

---

### **Code 11 Check Digit Verification**

Enable this parameter by scanning either One Check Digit bar code or Two Check Digits bar code.

When enabled, this parameter checks the integrity of a Code 11 symbol to ensure it complies with the specified check digit algorithm.

*Note: Enable Code 11 Check Digit Verification when Transmit Code 11 Check Digits is enabled.*

Set this parameter by scanning one of the bar codes shown below.

\* Disable Code 11 Check Digit Verification

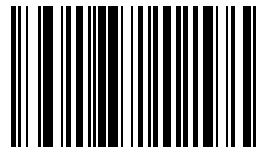

One Check Digit

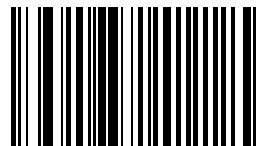

Two Check Digits

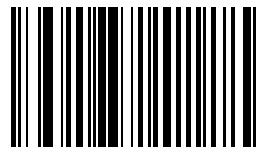

### **Transmit Code 11 Check Digits**

Code 11 Check Digit Verification must be enabled for this parameter to function.

Transmit (Enable) Code 11 Check Digits

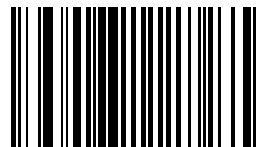

\* Do Not Transmit (Disable) Code 11 Check Digits

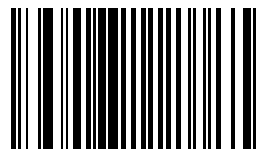

---

## Interleaved 2 of 5 (ITF)

When enabled, Interleaved 2 of 5 (I 2 of 5) symbols will be scanned, decoded and transmitted.  
Set this parameter by scanning either of the bar codes shown below.

\* Enable Interleaved 2 of 5

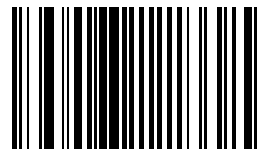

Disable Interleaved 2 of 5

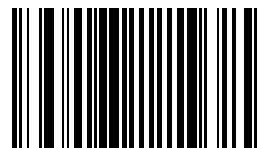

### Set Lengths for I 2 of 5

L1 Default: 14

L2 Default: 14

Lengths for Interleaved 2 of 5 may be set for:

any length,

one or two discrete lengths,

or lengths within a specific range.

The length of a code refers to the number of characters, including check digits, the code contains.

See the table titled [ASCII Character Equivalents](#) (page 6-1).

*Note: Due to the construction of the I 2 of 5 symbology, it is possible for a scan line covering only a portion of the code to be interpreted as a complete scan, yielding less data than is encoded in the bar code. To prevent this, select specific lengths (using I 2 of 5 – One Discrete Length and I 2 of 5 Two Discrete Lengths) for I 2 of 5 applications.*

#### One Discrete Length (Parameter L1)

This option decodes only those codes containing a selected length. For example, when you want to scan only I 2 of 5 symbols containing 14 characters, scan the “I 2 of 5 One Discrete Length” bar code and then “1” and “4” bar codes using the [Imager Keypad Number Symbols](#) (page 4-81).

To begin setting one discrete length, scan this I 2 of 5 One Discrete Length bar code:

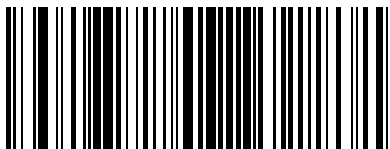

Next, scan two numeric bar codes that correspond to the desired value. Single digit numbers must have a leading zero. To correct an error or to change a selection, scan Cancel on the “Imager Keypad Number Symbols” page.

---

### ***Two Discrete Lengths (Parameter L2)***

This option decodes only those codes containing two selected lengths. For example, when you want to scan only 1 2 of 5 symbols containing 2 or 14 characters, scan the "1 2 of 5 Two Discrete Lengths" bar code and then "0", "2", "1" and "4" bar codes using the [Imager Keypad Number Symbols](#) (page 4-81).

To begin setting two discrete lengths, scan this 1 2 of 5 Two Discrete Lengths bar code:

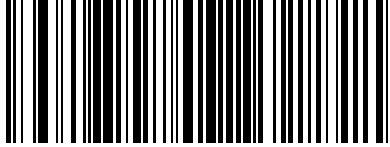

Next, scan four numeric bar codes that correspond to the desired value. Single digit numbers must have a leading zero. To correct an error or to change a selection, scan Cancel on the "Imager Keypad Number Symbols" page.

### ***Length Within Range***

This option decodes a code type within a specified minimum and maximum range. For example, when you want to scan only 1 2 of 5 symbols containing between 4 and 12 characters, scan the "1 2 of 5 Length Within Range" bar code and then "0", "4", "1" and "2" bar codes using the [Imager Keypad Number Symbols](#) (page 4-81).

To begin setting lengths within a range, scan this 1 2 of 5 Length within Range bar code:

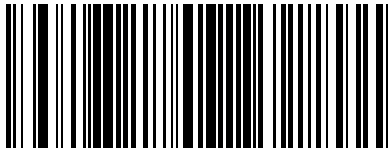

Next, scan numeric bar codes that correspond to the desired value. Single digit numbers must have a leading zero. To correct an error or to change a selection, scan Cancel on the "Imager Keypad Number Symbols" page.

### ***Any Length***

This option decodes 1 2 of 5 bar codes containing any number of characters.

Selecting this option may lead to misdecodes for 1 2 of 5 codes.

To set any length, scan this 1 2 of 5 Any Length bar code:

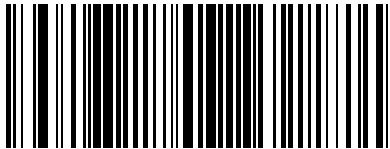

---

## ***1 2 of 5 Check Digit Verification***

When enabled, this parameter checks the integrity of an 1 2 of 5 symbol to ensure it complies with a specified algorithm, either USS (Uniform Symbology Specification) or OPCC (Optical Product Code Council).

Set this parameter by scanning one of the bar codes shown below.

\* Disable 1 2 of 5 Check Digit Verification

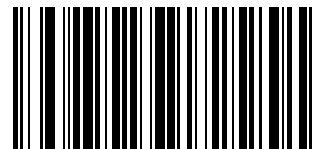

USS (Uniform Symbology Specification)

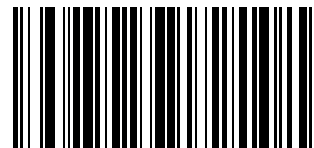

OPCC (Optical Product Code Council)

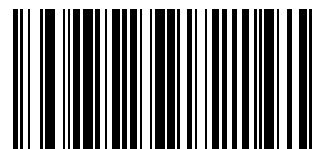

## ***Transmit 1 2 of 5 Check Digit***

When enabled, the check digit is transmitted with the data.

Parameter setting for “1 2 of 5 Check Digit Verification” has no effect on this parameter value.

Set this parameter by scanning either of the bar codes shown below.

Enable Transmit 1 2 of 5 Check Digit

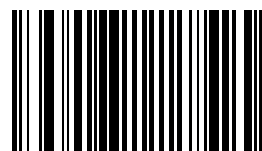

\* Disable Transmit 1 2 of 5 Check Digit

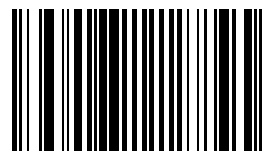

---

### **Convert I 2 of 5 to EAN 13**

A successful bar code conversion requires the following to be true:

Interleaved 2 of 5 scanning is enabled.

- One of the I 2 of 5 lengths is set to 14.
- The bar code has a leading zero.
- The bar code has a valid EAN-13 check digit.

When enabled, the parameter converts a 14 character I 2 of 5 bar code into EAN-13 and transmits it to the host as EAN-13.

Set this parameter by scanning either of the bar codes shown below.

Enable Convert I 2 of 5 to EAN-13

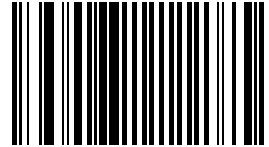

\* Disable Convert I 2 of 5 to EAN-13

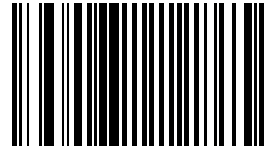

### **Discrete 2 of 5 (DTF)**

When enabled, Discrete 2 of 5 (D 2 of 5) symbols will be scanned, decoded and transmitted.

Set this parameter by scanning either of the bar codes shown below.

Enable Discrete 2 of 5

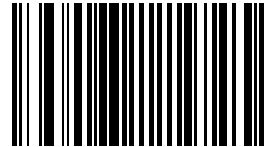

\* Disable Discrete 2 of 5

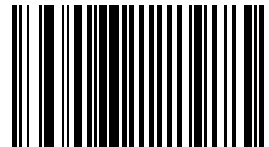

---

## Set Lengths for Discrete 2 of 5

L1 Default: 1    Discrete Length: 12

L2 Default: 12

Lengths for D 2 of 5 may be set for:

any length,

one or two discrete lengths,

or lengths within a specific range.

The length of a code refers to the number of characters, including check digits, the code contains.

See the table titled [ASCII Character Equivalents](#) (page 6-1).

*Note: Due to the construction of the D2 of 5 symbology, it is possible for a scan line covering only a portion of the code to be interpreted as a complete scan, yielding less data than is encoded in the bar code. To prevent this, select specific lengths (using D2 of 5 – One Discrete Length and D 2 of 5 Two Discrete Lengths) for D 2 of 5 applications.*

*Note: One Discrete Length (Parameter L1)*

This option decodes only those codes containing a selected length. For example, when you want to scan only D 2 of 5 symbols containing 14 characters, scan the “D 2 of 5 One Discrete Length” bar code and then “1” and “4” bar codes using the [Imager Keypad Number Symbols](#) (page 4-81).

To begin setting one discrete length, scan this D 2 of 5 One Discrete Length bar code:

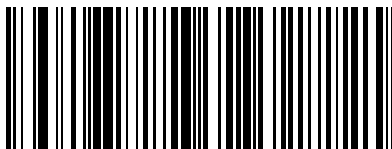

Next, scan two numeric bar codes that correspond to the desired value. Single digit numbers must have a leading zero. To correct an error or to change a selection, scan Cancel on the “Imager Keypad Number Symbols” page.

### **Two Discrete Lengths (Parameter L2)**

This option decodes only those codes containing two selected lengths. For example, when you want to scan only D 2 of 5 symbols containing 2 or 14 characters, scan the “D 2 of 5 Two Discrete Lengths” bar code and then “0”, “2”, “1” and “4” bar codes using the [Imager Keypad Number Symbols](#) (page 4-81).

To begin setting two discrete lengths, scan this D 2 of 5 Two Discrete Lengths bar code:

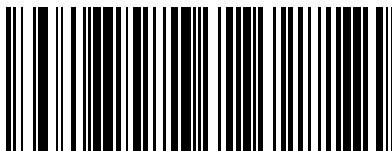

Next, scan four numeric bar codes that correspond to the desired value. Single digit numbers must have a leading zero. To correct an error or to change a selection, scan Cancel on the Imager Keypad Number Symbols page.



---

### **Length Within Range**

This option decodes a code type within a specified minimum and maximum range. For example, when you want to scan only D 2 of 5 symbols containing between 4 and 12 characters, scan the “D 2 of 5 Length Within Range” bar code and then “0”, “4”, “1” and “2” bar codes using the [Imager Keypad Number Symbols](#) (page 4-81).

To begin setting lengths within a range, scan this D 2 of 5 Length Within Range bar code:

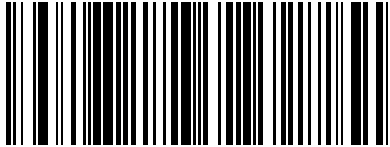

Next, scan numeric bar codes that correspond to the desired value. Single digit numbers must have a leading zero. To correct an error or to change a selection, scan Cancel on the “Imager Keypad Number Symbols” page.

### **Any Length**

This option decodes D 2 of 5 bar codes containing any number of characters.

Selecting this option may lead to misdecodes for D 2 of 5 codes. See next note.

To set any length, scan this D 2 of 5 Any Length bar code:

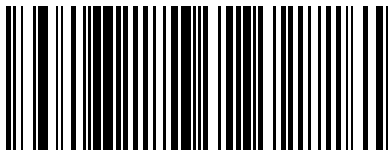

*Note: Due to the construction of the D2 of 5 symbology, it is possible for a scan line covering only a portion of the code to be interpreted as a complete scan, yielding less data than is encoded in the bar code. To prevent this, select specific lengths (using D2 of 5 – One Discrete Length and D 2 of 5 Two Discrete Lengths) for D 2 of 5 applications.*

---

## **Codabar**

When enabled, Codabar symbols will be scanned, decoded and transmitted.  
Set this parameter by scanning either of the bar codes shown below.

Enable Codabar

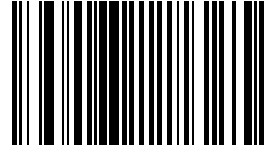

\* Disable Codabar

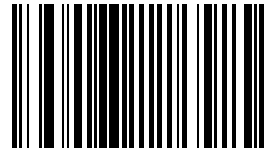

## **CLSI Editing**

When enabled, the start and stop characters are stripped from the bar code and a space is inserted after the 1<sup>st</sup>, 5<sup>th</sup>, and 10<sup>th</sup> characters of a 14 character Codabar symbol.

Set this parameter by scanning either of the bar codes shown below.

*Note: Symbol length does not include start and stop characters.*

Enable CLSI Editing

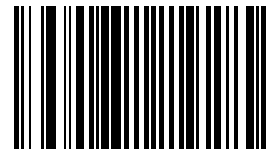

\* Disable CLSI Editing

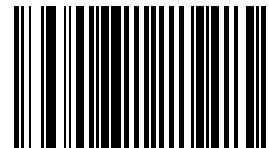

---

## **NOTIS Editing**

When enabled, the start and stop characters are stripped from a decoded Codabar symbol.  
Set this parameter by scanning either of the bar codes shown below.

Enable NOTIS Editing

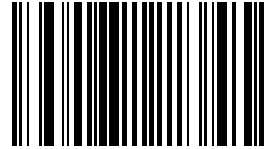

\* Disable NOTIS Editing

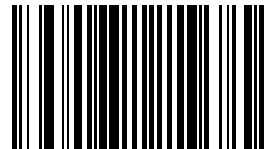

## **Set Lengths for Codabar**

L1 Default: 5

L2 Default: 55

Lengths for Codabar may be set for:

any length,

one or two discrete lengths,

or lengths within a specific range.

The length of a code refers to the number of characters, including check digits, the code contains. It also includes any start or stop characters.

See the table titled [ASCII Character Equivalents](#) (page 6-1).

### **One Discrete Length (Parameter L1)**

This option decodes only those codes containing a selected length. For example, when you want to scan only Codabar symbols containing 14 characters, scan the Codabar One Discrete Length bar code and then “1” and “4” bar codes using the [Imager Keypad Number Symbols](#) (page 4-81).

To begin setting one discrete length, scan this Codabar One Discrete Length bar code:

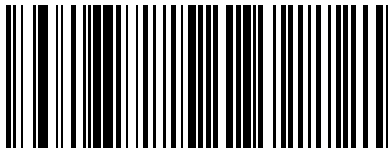

Next, scan two numeric bar codes that correspond to the desired value. Single digit numbers must have a leading zero. To correct an error or to change a selection, scan Cancel on the Imager Keypad Number Symbols page.

---

### ***Two Discrete Lengths (Parameter L2)***

This option decodes only those codes containing two selected lengths.

For example, when you want to scan only Codabar symbols containing 2 or 14 characters, scan the Codabar Two Discrete Lengths bar code and then “0”, “2”, “1” and “4” bar codes using the [Imager Keypad Number Symbols](#) (page 4-81).

To begin setting two discrete lengths, scan this Codabar Two Discrete Lengths bar code:

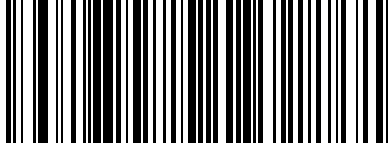

Next, scan four numeric bar codes that correspond to the desired value. Single digit numbers must have a leading zero. To correct an error or to change a selection, scan Cancel on the Imager Keypad Number Symbols page.

### ***Length Within Range***

This option decodes a code type within a specified minimum and maximum range. For example, when you want to scan only Codabar symbols containing between 4 and 12 characters, scan the Codabar Length Within Range bar code and then “0”, “4”, “1” and “2” bar codes using the [Imager Keypad Number Symbols](#) (page 4-81).

To begin setting lengths within a range, scan this Codabar Length Within Range bar code:

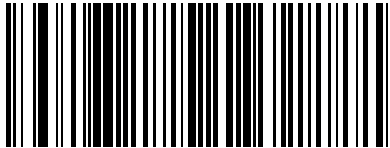

Next, scan numeric bar codes that correspond to the desired value using the Imager Keypad Number Symbols. Single digit numbers must have a leading zero. To correct an error or to change a selection, scan Cancel on the Imager Keypad Number Symbols page.

### ***Any Length***

This option decodes Codabar bar codes containing any number of characters.

To set any length, scan this Codabar Any Length bar code:

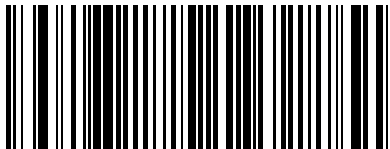

---

## MSI

When enabled, MSI symbols will be scanned, decoded and transmitted.  
Set this parameter by scanning either of the bar codes shown below.

Enable MSI

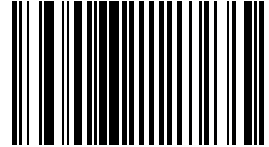

\* Disable MSI

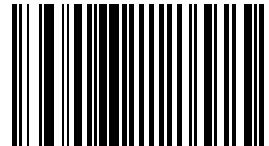

### Set Length(s) for MSI

Default: Length Within Range

L1 Default: 04

L2 Default: 55

Lengths for MSI may be set for:

- any length,
- one or two discrete lengths,
- or lengths within a specific range.

The length of a code refers to the number of characters, including check digits, the code contains.

See the table titled [ASCII Character Equivalents](#) (page 6-1).

*Note: Due to the construction of the MSI symbology, it is possible for a scan line covering only a portion of the code to be interpreted as a complete scan, yielding less data than is encoded in the bar code. To prevent this, select specific lengths (using MSI One Discrete Length and MSI Two Discrete Lengths) for MSI applications.*

*Note: One Discrete Length (Parameter L1)*

This option decodes only those codes containing a selected length. For example, when you want to scan only MSI symbols containing 14 characters, scan the “MSI One Discrete Length” bar code and then “1” and “4” bar codes using the [Imager Keypad Number Symbols](#) (page 4-81).

To begin setting one discrete length, scan this MSI One Discrete Length bar code:



Next, scan two numeric bar codes that correspond to the desired value. Single digit numbers must have a leading zero. To correct an error or to change a selection, scan Cancel on the “Imager Keypad Number Symbols” page.

---

### **Two Discrete Lengths (Parameter L2)**

This option decodes only those codes containing two selected lengths. For example, when you want to scan only MSI symbols containing 2 or 14 characters, scan the “MSI Two Discrete Lengths” bar code and then “0”, “2”, “1” and “4” bar codes using the [Imager Keypad Number Symbols](#) (page 4-81).

To begin setting two discrete lengths, scan this MSI Two Discrete Lengths bar code:

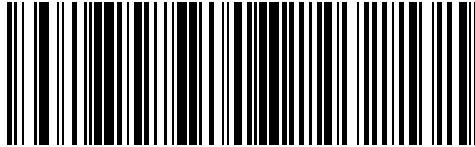

Next, scan four numeric bar codes that correspond to the desired value. Single digit numbers must have a leading zero. To correct an error or to change a selection, scan Cancel on the “Imager Keypad Number Symbols” page.

### **Length Within Range**

This option decodes a code type within a specified minimum and maximum range. For example, when you want to scan only MSI symbols containing between 4 and 12 characters, scan the “MSI Length Within Range” bar code and then “0”, “4”, “1” and “2” bar codes using the [Imager Keypad Number Symbols](#) (page 4-81).

To begin setting lengths within a range, scan this MSI Length Within Range bar code:

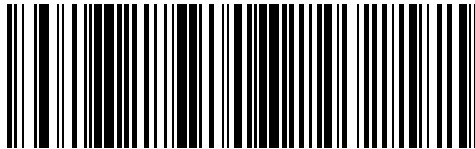

Next, scan numeric bar codes that correspond to the desired value. Single digit numbers must have a leading zero. To correct an error or to change a selection, scan Cancel on the “Imager Keypad Number Symbols” page.

### **Any Length**

This option decodes MSI bar codes containing any number of characters.

Selecting this option may lead to misdecodes for MSI codes. See following Note.

To set any length, scan this MSI Any Length bar code:

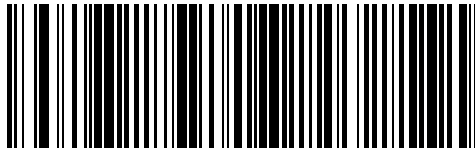

*Note: Due to the construction of the MSI symbology, it is possible for a scan line covering only a portion of the code to be interpreted as a complete scan, yielding less data than is encoded in the bar code. To prevent this, select specific lengths (using MSI One Discrete Length and MSI Two Discrete Lengths) for MSI applications.*

---

## **MSI Check Digits**

With MSI symbols, one check digit is mandatory and always verified by the reader. The second check digit is optional. If the MSI codes include two check digits, scan the Two MSI Check Digits bar code to enable verification of the second check digit.

Check digits are not automatically transmitted with the data.

*Note: When Two MSI Check Digits is selected, an MSI Check Digit Algorithm must also be selected.*

*Note: Set the number of check digits to be included with the bar code by scanning either of the bar codes shown below.*

\* One MSI check digit

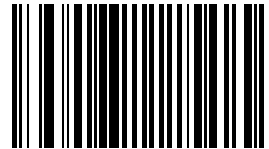

Two MSI check digits

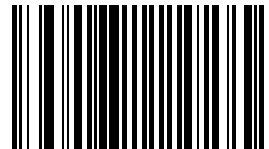

## **Transmit MSI Check Digit**

When enabled, the check digit is transmitted with the data.

Set this parameter by scanning either of the bar codes shown below.

Enable Transmit MSI Check Digit

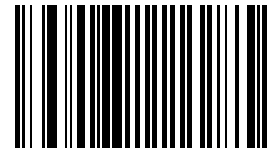

\* Disable Transmit MSI Check Digit

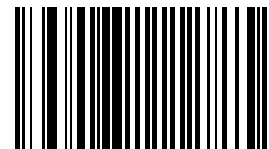

---

## **MSI Check Digit Algorithm**

With MSI symbols, one check digit is mandatory and always verified by the reader. The second check digit is optional. If the MSI codes include two check digits, scan the Two MSI Check Digits bar code to enable verification of the second check digit.

When the “Two MSI Check Digits” option is selected, an additional verification is required to ensure integrity. Either of the two following algorithms may be selected.

Set this parameter by scanning either of the bar codes shown below.

Mod 10/Mod 11  
MSI Check Digit Algorithm

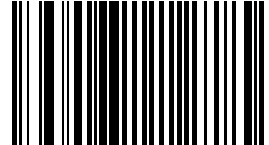

\* Mod 10/Mod 10  
MSI Check Digit Algorithm

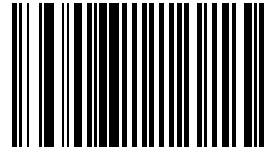

## **Postal Codes**

*Note: The default value for all Postal Code symbologies is “Enabled.” For best performance when reading a specific postal symbology, all other postal symbologies should be disabled.*

### **US Postnet**

To enable or disable US Postnet, scan the appropriate bar code:

\* Enable US Postnet

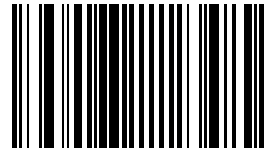

Disable US Postnet

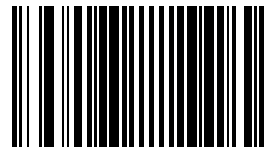



---

## ***US Planet***

To enable or disable US Planet, scan the appropriate bar code:

\* Enable US Planet

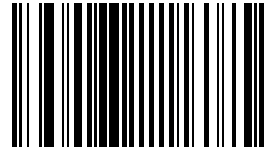

Disable US Planet

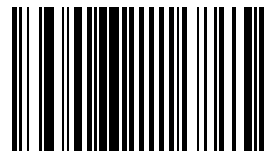

## ***UK Postal***

To enable or disable UK Postal, scan the appropriate bar code:

\* Enable UK Postal

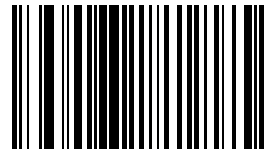

Disable UK Postal

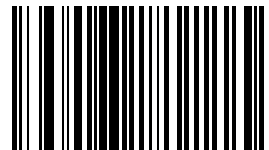

---

***Transmit UK Postal Check Digit***

Select whether to transmit UK Postal data with or without the check digit:

\* Transmit UK Postal Check Digit

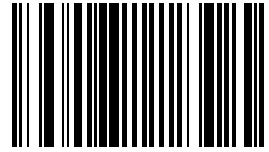

Do Not Transmit UK Postal Check Digit

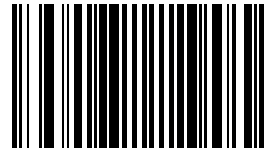

***Japan Postal***

To enable or disable Japan Postal, scan the appropriate bar code:

\* Enable Japan Postal

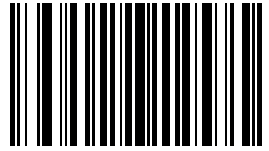

Disable Japan Postal

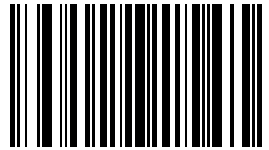

---

## ***Australian Postal***

To enable or disable Australian Postal, scan the appropriate bar code:

\* Enable Australian Postal

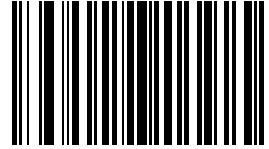

Disable Australian Postal

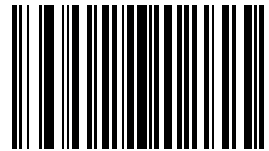

## ***Dutch Postal***

To enable or disable Dutch Postal, scan the appropriate bar code:

\* Enable Dutch Postal

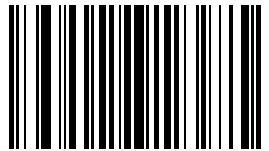

Disable Dutch Postal

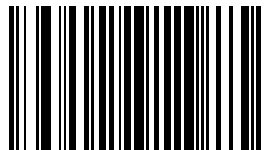

---

***Transmit US Postal Check Digit***

Select whether to transmit US Postal data with or without the check digit:

\* Transmit US Postal Check Digit

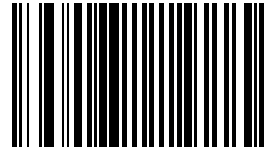

Do Not Transmit US Postal Check Digit

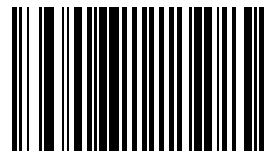

***4 State Postal***

To enable or disable 4 State Postal, scan the appropriate bar code:

Enable 4 State Postal

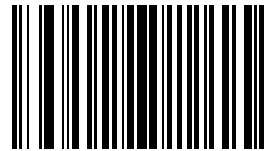

\* Disable 4 State Postal

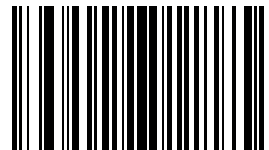

---

## **GS1 DataBar (RSS)**

The variants of GS1 DataBar [RSS (Reduced Space Symbology)] are GS1 DataBar Omnidirectional (RSS-14), GS1 DataBar Expanded (RSS Expanded) and GS1 DataBar Limited (RSS Limited). The limited and expanded versions have stacked variants.

Scan the appropriate bar codes that follow to enable or disable each variant of GS1 DataBar (RSS).

### **GS1 DataBar Omnidirectional (RSS-14)**

To enable or disable GS1 DataBar Omnidirectional (RSS-14), scan the appropriate bar code:

\* Enable GS1 DataBar Omnidirectional (RSS-14)

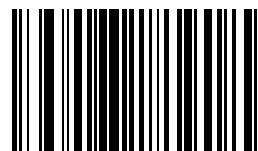

Disable GS1 DataBar Omnidirectional (RSS-14)

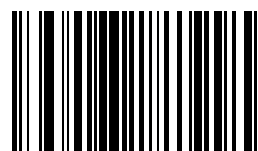

See Also: [Convert GS1 DataBar \(RSS\) to UPC/EAN](#) (page 4-68)

### **GS1 DataBar Limited (RSS Limited)**

To enable or disable GS1 DataBar Limited (RSS Limited), scan the appropriate bar code:

\* Enable GS1 DataBar Limited (RSS Limited)

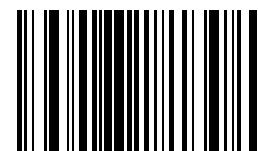

Disable GS1 DataBar Limited (RSS Limited)

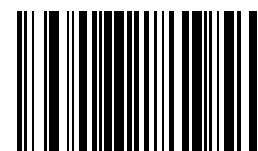

See Also: [Convert GS1 DataBar \(RSS\) to UPC/EAN](#) (page 4-68)

---

### ***GS1 DataBar Expanded (RSS Expanded)***

To enable or disable GS1 DataBar Expanded (RSS Expanded), scan the appropriate bar code:

\* Enable GS1 DataBar Expanded (RSS Expanded)

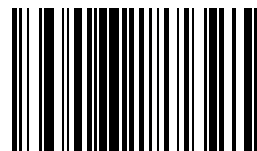

Disable GS1 DataBar Expanded (RSS Expanded)

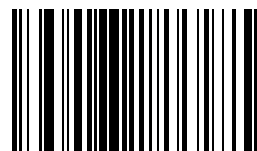

### ***Convert GS1 DataBar (RSS) to UPC/EAN***

This parameter only applies to GS1 DataBar Omnidirectional (RSS-14) and GS1 DataBar Limited (RSS Limited) symbols not decoded as part of a Composite symbol.

Enable this parameter to strip the leading "010" from GS1 DataBar Omnidirectional (RSS-14) and GS1 DataBar Limited (RSS Limited) symbols, encoding a single zero as the first digit, and report the bar code as EAN-13.

For bar codes beginning with two or more zeros but not six zeros this parameter strips the leading "0100" and reports the bar code as UPC-A. The UPC-A Preamble parameter that transmits the system character and country code applies to converted bar codes. Note that neither the system character nor the check digit can be stripped.

\* Enable Convert GS1 DataBar (RSS) to UPC/EAN

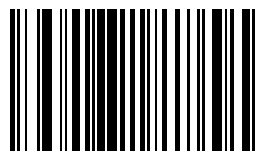

Disable Convert GS1 DataBar (RSS) to UPC/EAN

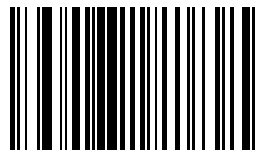

---

## **Composite**

### **Composite CC-C**

Scan one of the following bar codes to enable or disable Composite bar codes of type CC-C.

Enable Composite CC-C

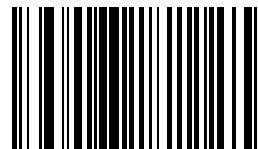

\* Disable Composite CC-C

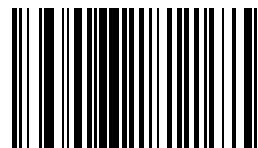

### **Composite CC-A/B**

Scan one of the following bar codes to enable or disable Composite bar codes of type CC-A/B.

Enable Composite CC-A/B

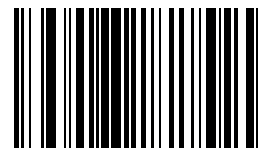

\* Disable Composite CC-A/B

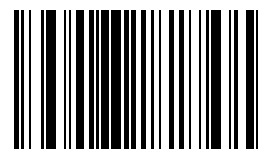

---

## **Composite TLC-39**

Scan one of the following bar codes to enable or disable Composite bar codes of type TLC-39.

Enable Composite TLC-39

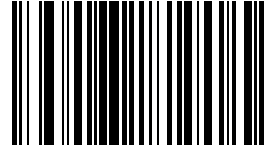

\* Disable Composite TLC-39

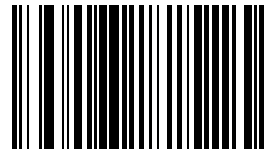

## **UPC Composite Mode**

UPC symbols can be linked with a 2D symbol during transmission as if they were one symbol. There are three options for these symbols:

UPC Never Linked	Transmit UPC bar codes regardless of whether a 2D symbol is detected.
UPC Always Linked	Transmit UPC bar codes and the 2D portion. If 2D is not present, the UPC bar code does not transmit.
Autodiscriminate UPC Composites	The decoding engine determines if there is a 2D portion, then transmits the UPC, as well as the 2D portion if present.

UPC Never Linked

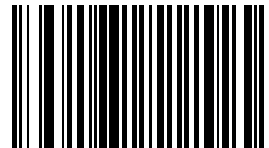

\* UPC Always Linked

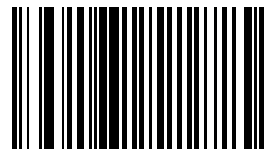

Autodiscriminate UPC Composites

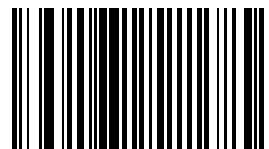

UCC/EAN Code 128 Emulation Mode



---

Select whether to enable or disable UCC/EAN Code 128 Emulation Mode for UCC/EAN Composite Codes.

Enable UCC/EAN Code 128 Emulation Mode for  
UCC/EAN Composite Codes

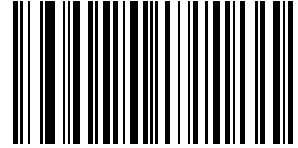

\* Disable UCC/EAN Code 128 Emulation Mode for  
UCC/EAN Composite Codes

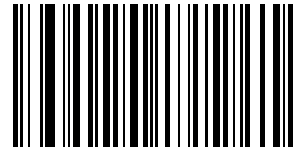

## ***2D Symbologies***

### ***Aztec***

To enable or disable Aztec, scan the appropriate bar code below.

\* Enable Aztec

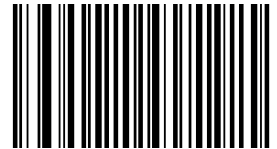

Disable Aztec



---

## ***Aztec Inverse***

This parameter controls the setting of the Aztec Inverse decoder. Scan the appropriate bar code below.

\* Regular Only

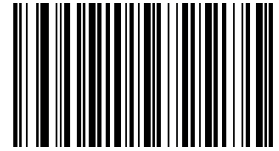

Inverse Only

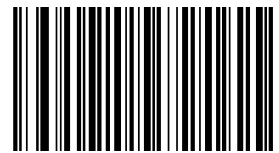

Inverse Auto Detect



## ***PDF417***

To enable or disable PDF417, scan the appropriate bar code below.

\* Enable PDF417

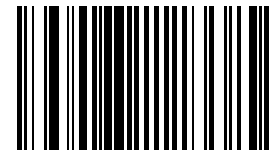

Disable PDF417

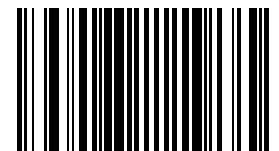

---

## **MicroPDF417**

To enable or disable MicroPDF417, scan the appropriate bar code below.

Enable MicroPDF417

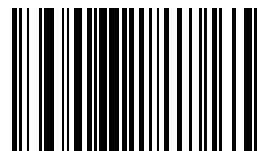

\* Disable MicroPDF417

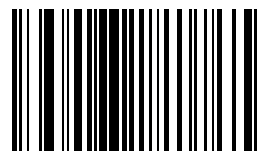

## **Code 128 Emulation**

To enable or disable Code 128 Emulation, scan the appropriate bar code below.

Enable Code 128 Emulation

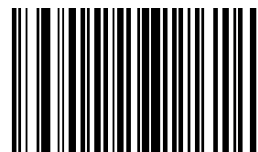

\* Disable Code 128 Emulation

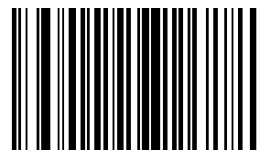

When this parameter is enabled, the scanner transmits data from certain MicroPDF417 symbols as if it was encoded in Code 128 symbols. Transmit AIM Symbology Identifiers must be enabled for this parameter to work.

If Code 128 Emulation is enabled, these MicroPDF417 symbols are transmitted with one of the following prefixes:

- ]C1 if the first codeword is 903-907, 912, 914, 915
- ]C2 if the first codeword is 908 or 909
- ]C0 if the first codeword is 910 or 911

If disabled, they are transmitted with one of the following prefixes:

- ]L3 if the first codeword is 903-907, 912, 914, 915
- ]L4 if the first codeword is 908 or 909
- ]L5 if the first codeword is 910 or 911

---

## ***Data Matrix***

To enable or disable Data Matrix, scan the appropriate bar code below.

\* Enable Data Matrix

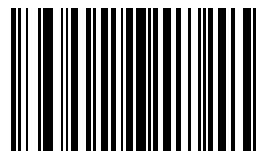

Disable Data Matrix

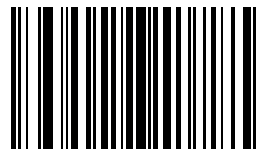

## ***Data Matrix Inverse***

This parameter controls the setting of the Data Matrix inverse decoder. Scan the appropriate bar code below.

\* Regular Only



Inverse Only



Inverse Auto Detect



---

## **Maxicode**

To enable or disable Maxicode scan the appropriate bar code below.

\* Enable Maxicode

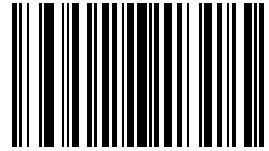

Disable Maxicode

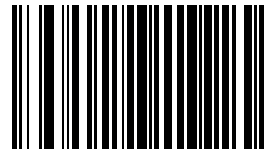

## **MicroQR**

To enable or disable MicroQR, scan the appropriate bar code below.

\* Enable MicroQR

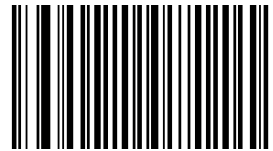

Disable MicroQR



---

## **QR Code**

To enable or disable QR Code scan the appropriate bar code below.

\* Enable QR Code

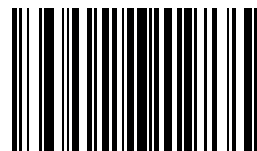

Disable QR Code

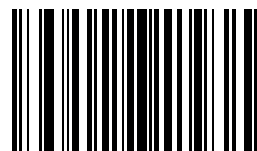

## **QR Inverse**

This parameter controls the setting of the QR Inverse decoder. Scan the appropriate bar code below.

\* Regular Only

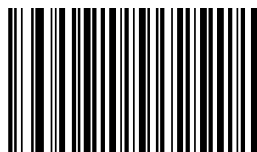

Inverse Only



Inverse Auto Detect

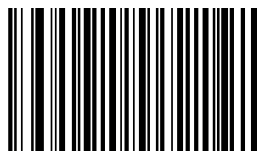

---

## ***Redundancy Level***

The decoder offers four levels of decode redundancy. Select higher redundancy levels for decreasing levels of bar code quality. As redundancy levels increase, the decoder's aggressiveness decreases.

Select the redundancy level appropriate for the bar code quality and then scan the appropriate Redundancy Level bar code.

### *Redundancy Level 1*

The following code types must be successfully read twice before being decoded:

<b>Code Type</b>	<b>Code Length</b>
Codabar	8 characters or less
MSI	4 characters or less
D 2 of 5	8 characters or less
I 2 of 5	8 characters or less

### *Redundancy Level 2*

The following code types must be successfully read twice before being decoded:

<b>Code Type</b>	<b>Code Length</b>
All	All

### *Redundancy Level 3*

Code types other than the following must be successfully read twice before being decoded. The following codes must be read three times:

<b>Code Type</b>	<b>Code Length</b>
MSI Plessey	4 characters or less
D 2 of 5	8 characters or less
I 2 of 5	8 characters or less
Codabar	8 characters or less

### *Redundancy Level 4*

The following code types must be successfully read three times before being decoded:

<b>Code Type</b>	<b>Code Length</b>
All	All

---

\* Redundancy Level 1

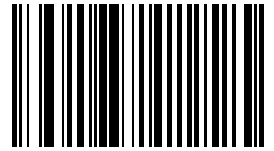

Redundancy Level 2

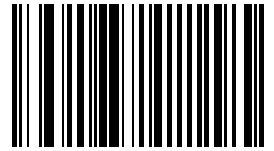

Redundancy Level 3

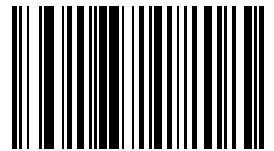

Redundancy Level 4

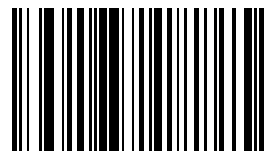



---

## Security Level

The decoder offers four levels of decode security for delta bar codes, which include the Code 128 family, UPC/EAN, and Code 93.

Select increasing levels of security for decreasing levels of bar code quality.

There is an inverse relationship between security and decoder aggressiveness, so choose only that level of security necessary for any given application.

Security Level 0	This setting allows the decoder to operate in its most aggressive state, while providing sufficient security in decoding most ?in-spec? bar codes.
Security Level 1	Select this option if misdecodes occur. This default setting should eliminate most misdecodes.
Security Level 2	Select this option if Security level 1 fails to eliminate misdecodes.
Security Level 3	If Security Level 2 was selected and misdecodes still occur, select this security level. Be advised, selecting this option is an extreme measure against misdecoding severely out of spec bar codes. Selecting this level of security significantly impairs the decoding ability of the decoder. If this level of security is necessary, try to improve the quality of the bar codes.

Select the security level appropriate for the bar code quality and then scan the appropriate Security Level bar code:

Security Level 0

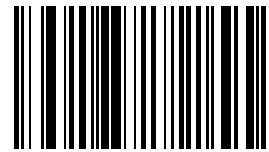

\* Security Level 1

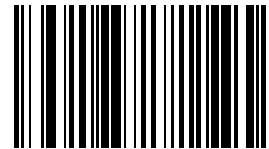

Security Level 2

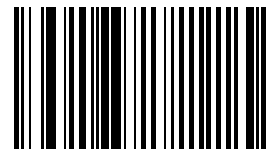

Security Level 3

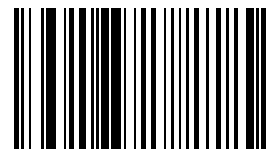

---

## ***Intercharacter Gap Size***

The Code 39 and Codabar symbologies have an intercharacter gap that is typically quite small. Due to various bar code-printing technologies, this gap can grow larger than the maximum size allowed, preventing the decoder from decoding the symbol.

If this problem occurs, scan the Large Intercharacter Gaps parameter to tolerate these out-of-specification bar codes.

\* Normal Intercharacter Gaps



Large Intercharacter Gaps

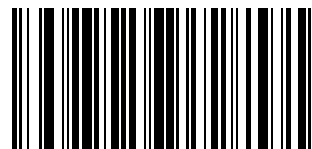

---

## ***Imager Keypad Number Symbols***

The bar code labels shown below represent a numeric keypad, with decimal values 0 through 9. Each label should be scanned individually.

Use these numeric value symbols to enter numeric input in the course of performing an imager engine system configuration.

To correct an error or change a selection, scan Cancel then scan a desired bar code.

0

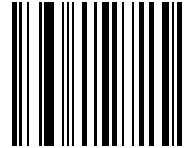

1

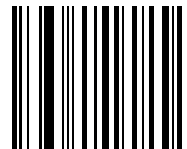

2

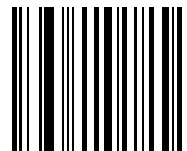

3

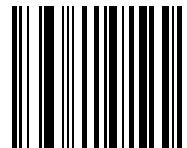

4

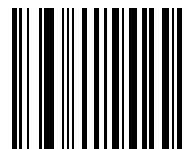

5

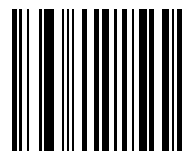



6

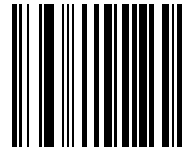

7

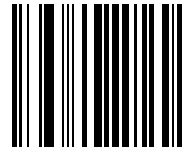

8

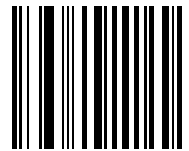

9

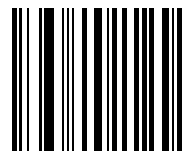

Cancel

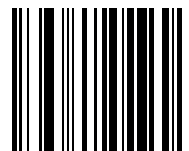

## Decode Zones

### Introduction

The scan ranges listed in the following tables are based on the following factors:

Decode zone is a function of various symbol characteristics including density, print contrast, wide-to-narrow ratio and edge acuity. Symbols test labels are examples of optimum quality bar codes.

As distance decreases the visible scan line also decreases (visible scan length = 1.8 x distance to label x TAN (scan angle / 2)). The usable scan length is approximately 90% of visible scan line and must fully encompass the bar code label to be successfully decoded. On larger symbol densities of 20 mil, 40 mil and 55 mil, this affects minimum decode distance.

+ / - 5° pitch is used to reduce the inhibiting effects of spectral reflection (glare) near 0° of the scan head aspect to the bar code. Optimal operation is obtained at 2° to 15° pitch offset.

Scan rate of 25 + / - scans second with bi-directional redundancy.

The long range and advanced long range scanners support the aim-mode feature which allows generation of the laser for aiming prior to actual bar code decoding with a duration from 1 sec to 8 sec.

The following “good scan and decode” ranges (decode zones) are related to a specific scan engine.

### Ring Laser

Factory Default Scan Angle -- Wide (47°)

Symbol Density	Typical Working Ranges		Guaranteed Working Ranges	
	Near	Far	Near	Far
4 mil	1.0 in / 2.50 cm	5.50 in / 13.97 cm	2.20 in / 5.60 cm	3.20 in / 8.13 cm
5 mil	1.25 in / 3.18 cm	8.00 in / 20.32 cm	2.20 in / 5.60 cm	5.50 in / 13.97 cm
7.5 mil	1.50 in / 3.81 cm	13.00 in / 33.02 cm	2.00 in / 5.08 cm	9.50 in / 24.13 cm
10 mil	1.50 in / 3.81 cm	18.00 in / 45.72 cm	1.75 in / 4.45 cm	14.00 in / 35.56 cm
13 mil	1.50 in / 3.81 cm	24.00 in / 60.96 cm	1.75 in / 4.45 cm	18.00 in / 45.72 cm
15 mil	1.50 in / 3.81 cm	28.00 in / 71.12 cm	1.75 in 4.45 cm	21.00 in / 53.34 cm
20 mil	1.75 in / 4.45 cm	33.00 in / 83.82 cm	*	27.00 in / 68.58 cm
40 mil	*	36.00 / 91.44 cm	*	28.00 in / 71.12 cm
55 mil	*	45.00 in / 114.30 cm	*	34.00 in / 86.36 cm

\* Near ranges are largely dependent upon the width of the bar code and the scan angle.

---

## Ring Imager

The decode distances in this section are based on the current Focus Mode setting in the ring imager. Note that when Far Focus is set, the imager is optimized to read at its far position. With Near Focus, the imager is optimized to read at its near position. Smart Focus toggles the focus position after every frame.

The decode distances in this section are based on the Focus Mode set currently in the ring imager.

### ***PL4407 Near Focus Decode Distances***

Symbol Density	Typical Working Ranges		Guaranteed Working Ranges	
	Near	Far	Near	Far
5.0 mil	3.5 in / 8.9 cm	7.0 in / 17.8 cm	4.25 in / 10.8 cm	6.0 in / 15.2 cm
6.67 mil	3.75 in / 9.5 cm	6.0 in / 15.2 cm	4.5 in / 11.4 cm	5.75 in / 14.6 cm
7.5 mil	2.75 in / 7.0 cm	7.75 in / 19.7 cm	3.5 in / 8.9 cm	6.5 in / 16.5 cm
10 mil	3.25 in / 8.3 cm	7.25 in / 18.4 cm	4.0 in / 10.2 cm	6.5 in / 16.5 cm
13 mil	2.25 in / 5.7 cm	8.75 in / 22.2 cm	3.0 in / 7.6 cm	7.0 in / 17.8 cm
15 mil	*	7.5 in / 19.1 cm	*	7.0 in / 17.8 cm
20 mil	*	11.0 in / 27.9 cm	*	9.5 in / 24.1 cm

\* Near ranges are field-of-view limited. Working range specifications at temperature 23° C.

### ***PL4407 Far Focus Decode Distances***

Symbol Density	Typical Working Ranges		Guaranteed Working Ranges	
	Near	Far	Near	Far
5.0 mil	6.5 in / 16.5 cm	7.5 in / 19.1 cm	N/A	N/A
6.67 mil	N/A	N/A	N/A	N/A
7.5 mil	4.25 in / 10.8 cm	10.0 in / 25.4 cm	5.5 in / 14.0 cm	8.5 in / 21.6 cm
10 mil	5.75 in / 14.6 cm	10.25 in / 26.0 cm	6.5 in / 16.5 cm	9.5 in / 24.1 cm
13 mil	3.0 in / 7.6 cm	16.0 in / 40.6 cm	3.75 in / 9.5 cm	13 in / 33.0 cm
15 mil	*	13.75 in / 34.9 cm	*	12.75 in / 32.4 cm
20 mil	*	21.5 in / 51.6 cm	*	17.0 in / 43.2 cm

\* Near ranges are field-of-view limited. Working range specifications at temperature 23° C.

### ***PL4407 Toggled Focus Decode Distances***

Symbol Density	Typical Working Ranges		Guaranteed Working Ranges	
	Near	Far	Near	Far
5.0 mil	3.5 in / 8.9 cm	7.5 in / 19.1 cm	4.25 in / 10.8 cm	6.0 in / 15.24 cm
6.67 mil	3.75 in / 9.5 cm	6.0 in / 15.24 cm	4.5 in / 11.4 cm	5.75 in / 14.61 cm
7.5 mil	2.75 in / 7.0 cm	10.0 in / 25.4 cm	3.5 in / 8.9 cm	8.5 in / 21.6 cm
10 mil	3.25 in / 8.3 cm	10.25 in / 26.0 cm	4.0 in / 10.2 cm	9.5 in / 24.1 cm
13 mil	2.25 in / 5.7 cm	16.0 in / 40.6 cm	3.0 in / 7.6 cm	13 in / 33.0 cm
15 mil	*	13.75 in / 34.9 cm	*	12.75 in / 32.4 cm
20 mil	*	21.5 in / 51.6 cm	*	17.0 in / 43.2 cm

\* Near ranges are field-of-view limited. Working range specifications at temperature 23° C.

### ***PL4407 Decode Distances in Darkness***

Symbol Density	Focus Position	Typical Working Ranges	
		Near	Far
5.0 mil	Near	3.5 in / 8.9 cm	5.875 in / 14.1 cm
	Far	6.5 in / 16.5 cm	N/A
6.67 mil	Near	3.75 in / 9.5 cm	5.75 in / 14.6 cm
	Far	N/A	N/A
7.5 mil	Near	2.75 in / 7.0 cm	6.875 in / 17.5 cm
	Far	4.25 in / 10.8 cm	7.125 in / 18.1 cm
10 mil	Near	3.25 in / 8.3 cm	6.375 in / 16.2 cm
	Far	5.75 in / 14.6 cm	7.25 in / 18.4 cm
13 mil	Near	2.25 in / 5.7 cm	7.375 in / 18.7 cm
	Far	3.00 in / 7.6 cm	8.375 in / 21.3 cm

\* Near ranges are field-of-view limited. Working range specifications at temperature 23° C.





## Technical Specifications

### Ring Scanner / Imager

#### Technical Specifications

I/O Port	9 spring pin port (when used with Dolphin D70e in the Honeywell Wearable Solution) 22 spring-pin, symmetrical port (when used with HX2 or HX3)
Module Size	1D Ring Scanner: 1.9" x 1.1" x 1.1" (48mm x 28mm x 28mm) 2D Ring Imager: 1.9" x 1.1" x 1.3" (48mm x 28mm x 33mm)
Module Weight	1D Ring Scanner: 1.75oz / 49.6g 2D Ring Imager: 1.85oz / 52.4g

#### Environmental Specifications

Operating Temperature	-4° F to 122° F (-20° C to +50° C)
Storage Temperature	-22° F to 122° F (-30°C to +50°C)
Water and Dust Resistance	Sealed to IP-54 specifications or better
Humidity	5% to 95% relative humidity, non-condensing
Corrosion	Corrosion resistant when exposed to water and common cleaning chemicals
Chemical Resistance	Corrosion resistant when exposed to water and common cleaning chemicals
Abrasion Resistance	Housing resists normal abrasion from dirty hands.

### ASCII Character Equivalents

Values from 1128 through 1255 (hex values 80h through FFh) may also be set. But the conversion of those characters to printable characters is not standardized. Therefore, they are not included in the table.

Scan Value	Hex Value	Full ASCII Code 39 Encode Char.	Keystroke
1000	00h	%U	CTRL 2
1001	01h	\$A	CTRL A
1002	02h	\$B	CTRL B
1003	03h	\$C	CTRL C
1004	04h	\$D	CTRL D
1005	05h	\$E	CTRL E
1006	06h	\$F	CTRL F
1007	07h	\$G	CTRL G
1008	08h	\$H	CTRL H
1009	09h	\$I	CTRL I
1010	0Ah	\$J	CTRL J
1011	0Bh	\$K	CTRL K
1012	0Ch	\$L	CTRL L
1013	0Dh	\$M	CTRL M
1014	0Eh	\$N	CTRL N
1015	0Fh	\$O	CTRL O
1016	10h	\$P	CTRL P

Scan Value	Hex Value	Full ASCII Code 39 Encode Char.	Keystroke
1017	11h	\$Q	CTRL Q
1018	12h	\$R	CTRL R
1019	13h	\$S	CTRL S
1020	14h	\$T	CTRL T
1021	15h	\$U	CTRL U
1022	16h	\$V	CTRL V
1023	17h	\$W	CTRL W
1024	18h	\$X	CTRL X
1025	19h	\$Y	CTRL Y
1026	1Ah	\$Z	CTRL Z
1027	1Bh	%A	CTRL [
1028	1Ch	%B	CTRL \
1029	1Dh	%C	CTRL ]
1030	1Eh	%D	CTRL 6
1031	1Fh	%E	CTRL -
1032	20h	Space	Space
1033	21h	/A	!
1034	22h	/B	'
1035	23h	/C	#
1036	24h	/D	\$
1037	25h	/E	%
1038	26h	/F	&
1039	27h	/G	'
1040	28h	/H	(
1041	29h	/I	)
1042	2Ah	/J	*
1043	2Bh	/K	+
1044	2Ch	/L	,
1045	2Dh	-	-
1046	2Eh	.	.
1047	2Fh	/	/
1048	30h	0	0
1049	31h	1	1
1050	32h	2	2
1051	33h	3	3
1052	34h	4	4
1053	35h	5	5
1054	36h	6	6
1055	37h	7	7
1056	38h	8	8
1057	39h	9	9
1058	3Ah	/Z	:
1059	3Bh	%F	;

Scan Value	Hex Value	Full ASCII Code 39 Encode Char.	Keystroke
1060	3Ch	%G	<
1061	3Dh	%H	=
1062	3Eh	%I	>
1063	3Fh	%J	?
1064	40h	%V	@
1065	41h	A	A
1066	42h	B	B
1067	43h	C	C
1068	44h	D	D
1069	45h	E	E
1070	46h	F	F
1071	47h	G	G
1072	48h	H	H
1073	49h	I	I
1074	4Ah	J	J
1075	4Bh	K	K
1076	4Ch	L	L
1077	4Dh	M	M
1078	4Eh	N	N
1079	4Fh	O	O
1080	50h	P	P
1081	51h	Q	Q
1082	52h	R	R
1083	53h	S	S
1084	54h	T	T
1085	55h	U	U
1086	56h	V	V
1087	57h	W	W
1088	58h	X	X
1089	59h	Y	Y
1090	5Ah	Z	Z
1091	5Bh	%K	[
1092	5Ch	%L	\
1093	5Dh	%M	]
1094	5Eh	%N	^
1095	5Fh	%O	-
1096	60h	%W	'
1097	61h	+A	a
1098	62h	+B	b
1099	63h	+C	c
1100	64h	+D	d
1101	65h	+E	e
1102	66h	+F	f

Scan Value	Hex Value	Full ASCII Code 39 Encode Char.	Keystroke
1103	67h	+G	g
1104	68h	+H	h
1105	69h	+I	i
1106	6Ah	+J	j
1107	6Bh	+K	k
1108	6Ch	+L	l
1109	6Dh	+M	m
1110	6Eh	+N	n
1111	6Fh	+O	o
1112	70h	+P	p
1113	71h	+Q	q
1114	72h	+R	r
1115	73h	+S	s
1116	74h	+T	t
1117	75h	+U	u
1118	76h	+V	v
1119	77h	+W	w
1120	78h	+X	x
1121	79h	+Y	y
1122	7Ah	+Z	z
1123	7Bh	%P	{
1124	7Ch	%Q	
1125	7Dh	%R	}
1126	7Eh	%S	~
1127	7Fh		Undefined

## Customer Support

### Technical Assistance

If you need assistance installing or troubleshooting your device, please contact us by using one of the methods below:

**Knowledge Base:** [www.hsmknowledgebase.com](http://www.hsmknowledgebase.com)

Our Knowledge Base provides thousands of immediate solutions. If the Knowledge Base cannot help, our Technical Support Portal (see below) provides an easy way to report your problem or ask your question.

**Technical Support Portal:** [www.hsmsupportportal.com](http://www.hsmsupportportal.com)

The Technical Support Portal not only allows you to report your problem, but it also provides immediate solutions to your technical issues by searching our Knowledge Base. With the Portal, you can submit and track your questions online and send and receive attachments.

**Web form:** [www.hsmcontactsupport.com](http://www.hsmcontactsupport.com)

You can contact our technical support team directly by filling out our online support form. Enter your contact details and the description of the question/problem.

**Telephone:** [www.honeywellaidc.com/locations](http://www.honeywellaidc.com/locations)

For our latest contact information, please check our website at the link above.

### Product Service and Repair

Honeywell International Inc. provides service for all of its products through service centers throughout the world. To obtain warranty or non-warranty service, please visit [www.honeywellaidc.com](http://www.honeywellaidc.com) and select **Support > Contact Service and Repair** to see your region's instructions on how to obtain a Return Material Authorization number (RMA #). You should do this prior to returning the product.

### Limited Warranty

Honeywell International Inc. ("HII") warrants its products to be free from defects in materials and workmanship and to conform to HII's published specifications applicable to the products purchased at the time of shipment. This warranty does not cover any HII product which is (i) improperly installed or used; (ii) damaged by accident or negligence, including failure to follow the proper maintenance, service, and cleaning schedule; or (iii) damaged as a result of (A) modification or alteration by the purchaser or other party, (B) excessive voltage or current supplied to or drawn from the interface connections, (C) static electricity or electrostatic discharge, (D) operation under conditions beyond the specified operating parameters, or (E) repair or service of the product by anyone other than HII or its authorized representatives.

This warranty shall extend from the time of shipment for the duration published by HII for the product at the time of purchase ("Warranty Period"). Any defective product must be returned (at purchaser's expense) during the Warranty Period to HII factory or authorized service center for inspection. No product will be accepted by HII without a Return Materials Authorization, which may be obtained by contacting HII. In the event that the product is returned to HII or its authorized service center within the Warranty Period and HII determines to its satisfaction that the product is defective due to defects in materials or workmanship, HII, at its sole option, will either repair or replace the product without charge, except for return shipping to HII.

EXCEPT AS MAY BE OTHERWISE PROVIDED BY APPLICABLE LAW, THE FOREGOING WARRANTY IS IN LIEU OF ALL OTHER COVENANTS OR WARRANTIES, EITHER EXPRESSED OR IMPLIED, ORAL OR WRITTEN, INCLUDING, WITHOUT LIMITATION, ANY IMPLIED WARRANTIES OF MERCHANTABILITY OR FITNESS FOR A PARTICULAR PURPOSE, OR NON-INFRINGEMENT.

HII'S RESPONSIBILITY AND PURCHASER'S EXCLUSIVE REMEDY UNDER THIS WARRANTY IS LIMITED TO THE REPAIR OR REPLACEMENT OF THE DEFECTIVE PRODUCT WITH NEW OR REFURBISHED PARTS. IN NO EVENT SHALL HII BE LIABLE FOR INDIRECT, INCIDENTAL, OR CONSEQUENTIAL DAMAGES, AND, IN NO EVENT, SHALL ANY LIABILITY OF HII ARISING IN CONNECTION WITH ANY PRODUCT SOLD HEREUNDER (WHETHER SUCH LIABILITY ARISES FROM A CLAIM BASED ON CONTRACT, WARRANTY, TORT, OR OTHERWISE) EXCEED THE ACTUAL AMOUNT PAID TO HII FOR THE PRODUCT. THESE LIMITATIONS ON LIABILITY SHALL REMAIN IN FULL FORCE AND EFFECT EVEN WHEN HII MAY HAVE BEEN ADVISED OF THE POSSIBILITY OF SUCH INJURIES, LOSSES, OR DAMAGES. SOME STATES, PROVINCES, OR COUNTRIES DO NOT ALLOW THE EXCLUSION OR LIMITATIONS OF INCIDENTAL OR CONSEQUENTIAL DAMAGES, SO THE ABOVE LIMITATION OR EXCLUSION MAY NOT APPLY TO YOU.

---

All provisions of this Limited Warranty are separate and severable, which means that if any provision is held invalid and unenforceable, such determination shall not affect the validity of enforceability of the other provisions hereof. Use of any peripherals not provided by the manufacturer may result in damage not covered by this warranty. This includes but is not limited to: cables, power supplies, cradles, and docking stations. HII extends these warranties only to the first end-users of the products. These warranties are non-transferable.

The duration of the limited warranty for the 8600 Series Ring Scanner Module is 1 year.

The duration of the limited warranty for the 8600 Series Ring Scanner Module Ring Scanner and Ring Imager is 1 year.

The duration of the limited warranty for the 8600 Series Ring Scanner fabric accessories (e.g., case, straps) is 90 days.



Honeywell Scanning & Mobility  
9680 Old Bailes Road  
Fort Mill, SC 29707  
[www.honeywellaidc.com](http://www.honeywellaidc.com)