

# STB3578 CRADLE with FIPS STB3574 INDUSTRIAL ETHERNET CRADLE QUICK REFERENCE GUIDE



Zebra reserves the right to make changes to any product to improve reliability, function, or design. Zebra does not assume any product liability arising out of, or in connection with, the application or use of any product, circuit, or application described herein. No license is granted, either expressly or by implication, estoppel, or otherwise under any patent right or patent, covering or relating to any combination, system, apparatus, machine, material, method, or process in which Zebra products might be used. An implied license exists only for equipment, circuits, and subsystems contained in Zebra products.

## Warranty

For the complete Zebra hardware product warranty statement, go to: <http://www.zebra.com/warranty>.

## For Australia Only:

This warranty is given by Zebra Technologies Asia Pacific Pte. Ltd., 71 Robinson Road, #05-02/03, Singapore 068895, Singapore. Our goods come with guarantees that cannot be excluded under the Australia Consumer Law. You are entitled to a replacement or refund for a major failure and compensation for any other reasonably foreseeable loss or damage. You are also entitled to have the goods repaired or replaced if the goods fail to be of acceptable quality and the failure does not amount to a major failure.

Zebra Technologies Corporation Australia's limited warranty above is in addition to any rights and remedies you may have under the Australian Consumer Law. If you have any queries, please call Zebra Technologies Corporation at +65 6858 0722. You may also visit our website: <http://www.zebra.com> for the most updated warranty terms.

## Service Information

If you have a problem using the equipment, contact your facility's Technical or Systems Support. If there is a problem with the equipment, they will contact the Zebra Support at: <http://www.zebra.com/support>.

For the latest version of this guide go to: [www.zebra.com/support](http://www.zebra.com/support).



Zebra Technologies Corporation  
3 Overlook Point  
Lincolnshire, IL U.S.A.  
<http://www.zebra.com>

© 2017 ZIH Corp and/or its affiliates. All rights reserved. ZEBRA and the stylized Zebra head are trademarks of ZIH Corp, registered in many jurisdictions worldwide. All other trademarks are the property of their respective owners.



72-150220-06 - May 2017 - Revision A

## Introduction

This guide applies to the STB3578 with FIPS, and STB3574 Industrial Ethernet cradles.

- The STB3578 with FIPS cradle receives data from the scanner via a Bluetooth radio, and sends that data to the host through an attached cable. The STB3578 cradle can also be used with LS3578 scanners for charging and radio communication.
- The STB3574 Industrial Ethernet cradle receives and transfers data via a configurable Ethernet IP address. The cradle can be configured to use one of three Industrial Ethernet Protocols: PROFINET, EtherNet/IP, and Modbus TCP. Go to: <https://www.zebra.com/us/en/support-downloads.html> to download the configuration software for this cradle.

Both cradles charge the scanner's internal battery pack when the scanner is inserted. The scanner can be charged from an external power supply, or a powered host cable.

This document provides basic instructions on setting up and using the cradle. Any discussion about transmission of data refers specifically to the STB3578 cradle. Refer to the *STB3574 Industrial Ethernet Developer Cradle Developer Guide*, p/n MN-002694-01, for detailed information about receiving and transferring data with the STB3574 cradle.

**CAUTION** LS3478 and DS3478 cordless scanners are incompatible with STB3508/3578 cradles. LS3578 and DS3578 cordless scanners are incompatible with STB3408/3478 cradles.

**IMPORTANT** It is recommended that a cable with a shielded modular plug be used with STB3578-CF and FLB3578-CF cradles.

## Equipment Supplied

The STB3578 and STB3574 cradle packages include:

- Cradle
- Four rubber feet (for desk mounting).

## Accessories

The following equipment may be needed:

- Three 1.5" #8 Phillips head screws (for wall mounting, if applicable, not available from Zebra).
- Power supply for desk/wall mounting configuration.

Save the shipping container for storing or shipping. Inspect all equipment for damage. If anything is damaged or missing, call an authorized Zebra Support Center immediately.

## Related Documentation

- LS3578 Product Reference Guide*, p/n 72E-93911-xx.
- LS3578 Quick Start Guide*, p/n 72-93587-xx.
- DS3578 with FIPS Product Reference Guide*, p/n 72E-153466-xx.
- DS3578 Quick Start Guide*, p/n 72-151247-xx.
- FLB3508/3578 Quick Reference Guide*, p/n 72-150221-xx.
- STB3574 Industrial Ethernet Cradle Product Reference Guide*.

All documentation is available at: [www.zebra.com/support](http://www.zebra.com/support).

## Cradle Parts

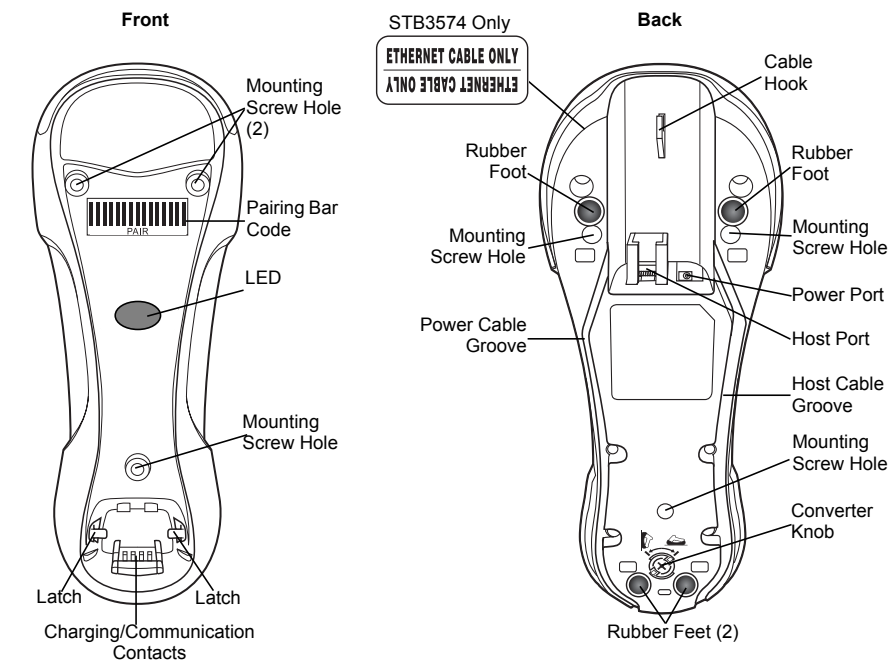

## Cradle Connections

**IMPORTANT** Connect the interface cable and power supply (if necessary) in the following order to ensure proper operation of the scanner and cradle.

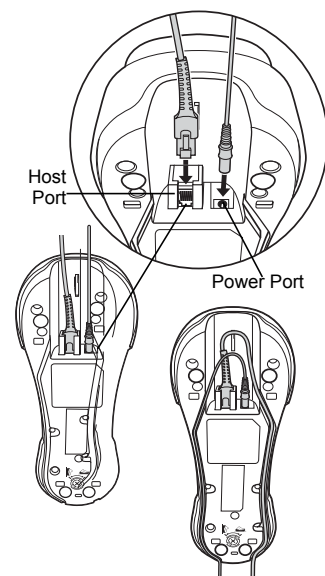

- Insert the interface cable into the cradle's host port.
- Connect the other end of the interface cable to the host.
- If necessary, connect the power supply to the cradle's power port (if required by the interface, or to allow fast charging of the scanner).
- Connect the appropriate cable to the power supply and an AC power source, if necessary.
- If applicable, thread the interface cable over the cable support hook and run the host and power cables into their respective cable grooves.
- If necessary, scan the appropriate host bar code (for non-autodetected interfaces). Refer to the *Product Reference Guide*.

## Changing the Host Interface (STB3578 only)

To connect the STB3578 cradle to a different host, or to the same host through a different cable:

- Unplug the power supply from the cradle.
- Unplug the interface cable from the host.
- Connect the interface cable to the new host, or the new interface cable to the existing host.
- Reconnect the power supply, if required.
- If necessary, scan the appropriate host bar code (for non-autodetected interfaces). Refer to the *Product Reference Guide*.

## Using a Host Interface to Supply Power

Some hosts can provide power to the cradle via the host interface, instead of an external power supply.

**CAUTION** If the scanner does not recognize the host, disconnect the power supply, then reconnect after connecting the host cable.

## Mounting the Cradle

### Horizontal Mount

- Ensure the desk/wall mount converter knob is in the correct position, shown at right.
- If mounting the cradle horizontally where no fastening is necessary, peel the protective paper from the back of the rubber feet included with the cradle packaging, and attach the feet to the cradle at the indentations in the plastic. These feet provide traction and prevent surface damage.

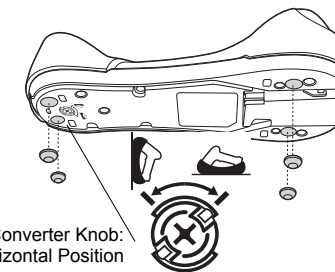

### Vertical Mount

**NOTE** Do not use the rubber feet when mounting in a vertical orientation.

### To mount the cradle on a vertical surface:

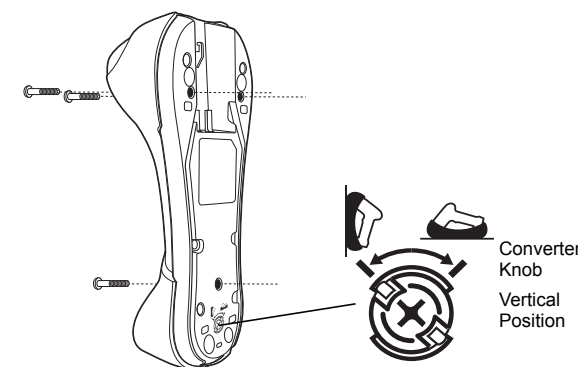

- Use a Phillips screwdriver to turn the desk/wall mount converter knob to the position shown below. The front latches protract to engage the depressions at the base of the scanner's handle.
- Attach the interface and power cables to the appropriate ports (see *Cradle Connections*).
- Press the cables into the cable grooves.
- Position the cradle on the mounting surface, or use the template included in this guide.
- Mark the surface through the three holes on the bottom of the cradle, or use the mounting template to determine the location of the screw holes.
- Pre-drill holes to accommodate three 1.5" #8 Phillips head screws.
- Attach the cradle securely to the surface.
- Place the scanner in the cradle.

**CAUTION** Do not pour, spray, or spill any liquid on the cradle.

## Inserting the Scanner in the Cradle

To insert the scanner in the cradle:

- Insert the scanner top first. Push the handle until it clicks into place, engaging the contacts in the cradle and scanner.

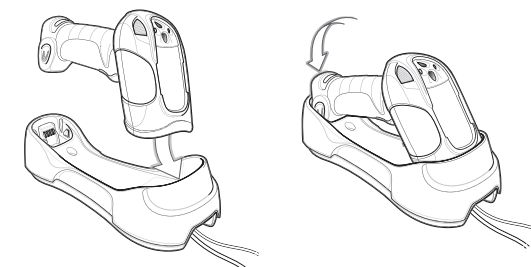

## Sending Data to the Host Computer

The cradle receives data from the scanner via a wireless radio connection and transmits it to the host computer via the host cable. The scanner and cradle must be paired for successful wireless communication.

### Pairing

Pairing registers a scanner to the cradle such that the scanner and cradle can exchange information. The STB357X operates in two modes: Point-to-Point (scanner-to-cradle) and Multipoint-to-Point (multi scanner-to-cradle). In Point-to-Point mode, the scanner is paired to the cradle either by insertion into the cradle (if pairing on insertion is enabled), or by scanning the pairing bar code. In Multipoint-to-Point mode, up to three scanners can be paired to one cradle when using a *Non-FIPS* digital scanner and cradle. When using a FIPS enabled digital scanner and a FIPS enabled cradle, up to seven digital scanners can be paired to one cradle. The multipoint bar code must be scanned to activate this feature. Refer to the *Product Reference Guide* for more information.

The cradle includes pairing bar codes on both its front and back. To pair the scanner with the cradle, scan a pairing bar code. A high-low-high-low beep sequence followed by a low-high beep sequence indicates successful pairing and connection to the remote device. A long low, long high beep sequence indicates unsuccessful pairing. Refer to the *Product Reference Guide* for more information.

### Lost Connection to Host

If scanned data does not transmit to the cradle's host, ensure that all cables are firmly inserted and the power supply is connected to an appropriate AC outlet, if applicable. If scanned data still does not transmit to the host, reestablish a connection with the host:

- Disconnect the power supply from the cradle.
- Disconnect the host interface cable from the cradle.
- Wait three seconds.
- Reconnect the host interface cable to the cradle.
- Reconnect the power supply to the cradle, if required.
- Reestablish pairing with the cradle by scanning the pairing bar code.

**NOTE** The cradle does not always require a power supply, depending on the host interface

## Charging the Scanner Battery in the Cradle

To charge the scanner battery, place the scanner in the cradle (see *Inserting the Scanner in the Cradle*). The battery begins charging when the scanner LED indicator starts flashing green. A complete charge of a fully discharged battery can take up to 4.5 hours using external power and up to 10 hours using the interface cable.

## Scanner LED Indicators

The green LED on the scanner indicates charging activity (see the table below). If the scanner is charging in fast mode (non-bus powered mode), the green LED blinks at a fast rate. If the scanner is charging in slow mode (bus-powered mode), the LED blinks at a slow rate. If the red LED on the scanner begins flashing, indicating a charging problem, remove the scanner from the cradle and replace the battery. If the red LED on the scanner continues flashing, contact the Zebra Support Center.

Standard Scanner Use LED Sequences	
Off	No power applied to scanner (battery is discharged or removed); scanner is in low power and ready to scan.
Green	A bar code was successfully decoded.
Red	A data transmission error; scanner malfunction; or, LS3578 cordless scanner was inserted into an STB3478 cradle.
Charging Use LED Sequences	
Green Slow Flash	The scanner charges at the slow rate (used when the cradle is powered by the host cable).
Green Fast Flash	The scanner charges at the fast rate (used when cradle is powered from an external power supply).
Red Flash	Charging problem. Refer to the <i>Product Reference Guide</i> for more information.
Red and Green Flash	Temperature fault.

## Troubleshooting

If the cradle does not work after following the previous procedures:

- Check the system power.
- Check for loose cable connections.
- Check that the scanner is inserted properly in the cradle.
- Check that the host settings are correct and the cradle is connected to the appropriate port on the host.

## Regulatory Information

For devices with Symbol, or Symbol Technologies Inc., etc. on the Manufacturing Label and for devices manufactured at Reynosa, or any other Zebra factory facilities:

This device is approved under Zebra Technologies Corporation.

This guide applies to Model Numbers STB3574 and STB3578.

All Zebra devices are designed to be compliant with the rules and regulations in the locations they are sold and will be labeled as required.

Local language translations are available at the following website: [www.zebra.com/support](http://www.zebra.com/support).

Any changes or modifications to Zebra equipment not expressly approved by Zebra could void the user's authority to operate the equipment.

For use only with Zebra approved and UL Listed scanners, Zebra approved, and UL Listed/Recognized battery packs.

## Bluetooth® Wireless Technology

This is an approved Bluetooth® product. For more information or to view the End Product Listing, please visit <https://www.bluetooth.org/tg/listings.cfm>.

## Wireless Device Country Approvals

**NOTE** This section is only applicable to WW/WR/EU configurations.

Regulatory markings subject to certification are applied to the device signifying the radio(s) is/are approved for use in the following countries and continents: United States, Canada, Japan, China, South Korea, Australia, and Europe.

Please refer to the Declaration of Conformity (DoC) for details of other country markings. This is available at: [www.zebra.com/support](http://www.zebra.com/support).

**NOTE** Europe includes Austria, Belgium, Bulgaria, Croatia, Czech Republic, Cyprus, Denmark, Estonia, Finland, France, Germany, Greece, Hungary, Iceland, Ireland, Italy, Latvia, Liechtenstein, Lithuania, Luxembourg, Malta, Netherlands, Norway, Poland, Portugal, Romania, Slovak Republic, Slovenia, Spain, Sweden, Switzerland, and the United Kingdom.

**CAUTION** Operation of the device without regulatory approval is illegal.

## Health and Safety Recommendations

### Ergonomic Recommendations

**Caution:** In order to avoid or minimize the potential risk of ergonomic injury, follow the recommendations below. Consult with your local Health and Safety Manager to ensure that you are adhering to your company's safety programs to prevent employee injury.

- Reduce or eliminate repetitive motion
- Maintain a natural position
- Reduce or eliminate excessive force
- Keep objects that are used frequently within easy reach
- Perform tasks at correct heights
- Reduce or eliminate vibration
- Reduce or eliminate direct pressure
- Provide adjustable workstations
- Provide adequate clearance
- Provide a suitable working environment
- Improve work procedures.

### Potentially Hazardous Atmospheres - Fixed Installations

You are reminded of the need to observe restrictions on the use of radio devices in fuel depots, chemical plants etc. and areas where the air contains chemicals or particles such as grain, dust, or metal powders.



### Safety in Hospitals



Wireless devices transmit radio frequency energy and may affect medical electrical equipment.

Wireless devices should be switched off wherever you are requested to do so in hospitals, clinics, or healthcare facilities. These requests are designed to prevent possible interference with sensitive medical equipment.

Wireless devices transmit radio frequency energy and may affect medical electrical equipment. When installed adjacent to other equipment, it is advised to verify that the adjacent equipment is not adversely affected.

#### Pacemakers

Pacemaker manufacturers recommended that a minimum of 15cm (6 inches) be maintained between a hand-held wireless device and a pacemaker to avoid potential interference with the pacemaker. These recommendations are consistent with independent research and recommendations by Wireless Technology Research.

#### Persons with Pacemakers:

- Should ALWAYS keep the device more than 15cm (6 inches) from their pacemaker when turned ON.
- Should not carry the device in a breast pocket.
- Should use the ear furthest from the pacemaker to minimize the potential for interference.
- If you have any reason to suspect that interference is taking place, turn OFF your device.

#### Other Medical Devices

Please consult your physician or the manufacturer of the medical device to determine if the operation of your wireless product may interfere with the medical device.

#### RF Exposure Guidelines



#### Safety Information

#### • Reducing RF Exposure - Use Properly

Only operate the device in accordance with the instructions supplied.

#### • International

The device complies with internationally recognized standards covering human exposure to electromagnetic fields from radio devices. For information on 'International' human exposure to electromagnet fields, refer to the Zebra Declaration of Conformity (DoC) at <http://www.zebra.com/doc>.

For further information on the safety of RF energy from wireless devices, see

<http://responsibility.zebra.com/index.php/downloads/>, which is located under Wireless Communications and Health.

#### • Europe

#### • Remote and Standalone Antenna Configurations

To comply with EU RF exposure requirements, antennas that are mounted externally at remote locations or operating near users at stand-alone desktop of similar configurations must operate with a minimum separation distance of 20 cm from all persons.

#### • US and Canada

#### • Co-located statement

To comply with FCC RF exposure compliance requirement, the antenna used for this transmitter must not be co-located or operating in conjunction with any other transmitter/antenna except those already approved in this filing.

To satisfy US and Canadian RF exposure requirements, a transmitting device must operate with a minimum separation distance of 20 cm or more from a person's body.

Pour satisfaire aux exigences Américaines et Canadiennes d'exposition aux radio fréquences, un dispositif de transmission doit fonctionner avec une distance de séparation minimale de 20 cm ou plus de corps d'une personne.

#### • Remote and Standalone Antenna Configurations

To comply with FCC RF exposure requirements, antennas that are mounted externally at remote locations or operating near users at stand-alone desktop of similar configurations must operate with a minimum separation distance of 20 cm from all persons.

To satisfy FCC RF exposure requirements, a mobile transmitting device must operate with a minimum separation distance of 20 cm or more from a person's body.

### Power Supply

Use ONLY a Zebra approved UL LISTED ITE (IEC/EN 60950-1, LPS/SELV) power supply with electrical ratings: Output 12 Vdc, min 1.5 A, with a maximum ambient temperature of at least 40 degrees C. Use of alternative power supply will invalidate any approvals given to this unit and may be dangerous.

### Radio Frequency Interference Requirements- FCC



**Note:** This equipment has been tested and found to comply with the limits for a Class B digital device, pursuant to Part 15 of the FCC rules. These limits are designed to provide reasonable protection against harmful interference in a residential installation. This equipment generates, uses and can radiate radio frequency energy and, if not installed and used in accordance with the instructions, may cause harmful interference to radio communications. However there is no guarantee that interference will not occur in a particular installation. If this equipment does cause harmful interference to radio or television reception, which can be determined by turning the equipment off and on, the user is encouraged to try to correct the interference by one or more of the following measures:

- Reorient or relocate the receiving antenna.
- Increase the separation between the equipment and receiver.
- Connect the equipment into an outlet on a circuit different from that to which the receiver is connected.
- Consult the dealer or an experienced radio/TV technician for help.

#### Radio Transmitters (Part 15)

This device complies with Part 15 of the FCC Rules. Operation is subject to the following two conditions: (1) this device may not cause harmful interference, and (2) this device must accept any interference received including interference that may cause undesired operation.

### Radio Frequency Interference Requirements- Canada

CAN ICES-3 (B)/NMB-3(B)

#### Radio Transmitters

This device complies with Industry Canada's licence-exempt RSSs. Operation is subject to the following two conditions: (1) This device may not cause interference; and (2) This device must accept any interference, including interference that may cause undesired operation of the device.

Le présent appareil est conforme aux CNR d'Industrie Canada applicables aux appareils radio exempts de licence. L'exploitation est autorisée aux deux conditions suivantes : (1) l'appareil ne doit pas produire de brouillage; (2) l'utilisateur de l'appareil doit accepter tout brouillage radioélectrique subi, même si le brouillage est susceptible d'en compromettre le fonctionnement.

Label Marking: The Term 'IC:' before the radio certification only signifies that Industry Canada technical specifications were met.

## CE Marking and European Economic Area (EEA)

#### Statement of Compliance

Zebra hereby declares that this radio equipment is in compliance with Directive 2011/65/EU and 1999/5/EC or 2014/53/EU (2014/53/EU supersedes 1999/5/EC from 13th June 2017). The full text of the EU Declaration of Conformity is available at the following internet address: <http://www.zebra.com/doc>.

<b>Japan (VCCI) - Voluntary Control Council for Interference</b>
<div style="border: 1px solid black; padding: 5px;"> <p style="text-align: center;">この装置は、クラスB情報技術装置です。この装置は、家庭環境で使用することを目的としていますが、この装置がラジオやテレビジョン受信機に近接して使用されると、受信障害を引き起こすことがあります。取扱説明書に従って正しい取り扱いをして下さい。 <span style="float: right;">VCCI—B</span></p> </div>

<b>Korea</b>				
<table border="1"> <tbody><tr> <td style="text-align: center;">기종별</td> <td style="text-align: center;">사용자안내문</td></tr> <tr> <td style="text-align: center;">B급기기 (가정용 방송통신기기)</td> <td style="text-align: center;">이 기기는 가정용 (B급) 으로 전자파적합등록을 한 기기로서 주로 가정에서 사용하는 것을 목적으로 하며, 모든 지역에서 사용할 수 있습니다 .</td></tr> </tbody></table>	기종별	사용자안내문	B급기기 (가정용 방송통신기기)	이 기기는 가정용 (B급) 으로 전자파적합등록을 한 기기로서 주로 가정에서 사용하는 것을 목적으로 하며, 모든 지역에서 사용할 수 있습니다 .
기종별	사용자안내문			
B급기기 (가정용 방송통신기기)	이 기기는 가정용 (B급) 으로 전자파적합등록을 한 기기로서 주로 가정에서 사용하는 것을 목적으로 하며, 모든 지역에서 사용할 수 있습니다 .			

#### Other Countries

#### Brazil (UNWANTED EMISSIONS - ALL PRODUCTS)

Regulatory declarations for STB357X - BRAZIL

For more information consult the website [www.anatel.gov.br](http://www.anatel.gov.br).

Declarações Regulamentares para STB357X - Brazil

Nota: A marca de certificação se aplica ao Transceptor, modelo STB357X. Este equipamento opera em caráter secundário, isto é, não tem direito a proteção contra interferência prejudicial, mesmo de estações do mesmo tipo, e não pode causar interferência a sistemas operando em caráter primário. Para maiores informações sobre ANATEL consulte o site: [www.anatel.gov.br](http://www.anatel.gov.br)

Este equipamento opera em caráter secundário, isto é, não tem direito a proteção contra interferência prejudicial, mesmo de estações do mesmo tipo, e não pode causar interferência a sistemas operando em caráter primário.

#### Chile

Este equipo cumple con la Resolución No 403 de 2008, de la Subsecretaria de telecomunicaciones, relativa a radiaciones electromagnéticas.

#### China

通过访问以下网址可下载当地语言支持的产品说明书



#### Mexico

La operación de este equipo está sujeta a las siguientes dos condiciones: (1) es posible que este equipo o dispositivo no cause interferencia perjudicial y (2) este equipo o dispositivo debe aceptar cualquier interferencia, incluyendo la que pueda causar su operación no deseada.

#### South Korea

For a radio equipment using 2400~2483.5MHz or 5725~5825MHz, the following two expression should be displayed;

당해 무선설비는 운용 중 전파혼신 가능성이 있음

당해 무선설비는 전파혼신 가능성이 있으므로 인명안전과 관련된 서비스는 할 수 없습니다 .

#### Taiwan

#### 臺灣

低功率電波輻射性電機管理辦法

第十二條
經型式認證合格之低功率射頻電機，非經許可，公司、商號或使用者均不得擅自變更頻率、加大功率或變更原設計之特性及功能。

第十四條
低功率射頻電機之使用不得影響飛航安全及干擾合法通信；經發現有干擾現象時，應立即停用，並改善至無干擾時方得繼續使用。

前項合法通信，指依電信規定作業之無線電通信。低功率射頻電機須忍受合法通信或工業、科學及醫療用電波輻射性電機設備之干擾。

#### Ukraine

Дане обладнання відповідає вимогам технічного регламенту №1057, №-2008-на-обмеження-щодо-використання-деяких-небезпечних-речовин-в-електричних-та-електронних-пристроях.

#### Thailand

เครื่องโทรคมนาคมและอุปกรณ์นี้ มีความสอดคล้องตามข้อกำหนดของ กทข .

#### TURKISH WEEE Statement of Compliance

EEE Yönetmeliğine Uygundur

## China RoHS

	有害物质 <p></p>					
部件名称 (Parts)	铅 (Pb)	汞 (Hg)	镉 (Cd)	六价铬 (Cr (VI))	多溴联苯 (PBB)	多溴二苯醚 (PBDE)
金属部件 (Metal Parts)	X	○	○	○	○	○
电路模块 (Circuit Modules)	X	○	○	○	○	○
电缆及电缆组件 (Cables and Cable Assemblies)	X	○	○	○	○	○
塑料和聚合物部件 (Plastic and Polymeric Parts)	○	○	○	○	○	○
光学和光学组件 (Optics and Optical Components)	○	○	○	○	○	○
电池 (Batteries)	○	○	○	○	○	○

本表格依据SJ/T 11364 的规定编制。

○: 表示该有害物质在该部件所有均质材料中的含量均在 GB/T 26572 规定的限量要求以下。
X: 表示该有害物质至少在该部件的某一均质材料中的含量超出GB/T 26572 规定的限量要求。（企业可在此处，根据实际情况对上表中打“×”的技术原因进行进一步说明。）

This table was created to comply with China RoHS requirements.



## Waste Electrical and Electronic Equipment (WEEE)

**English:** For EU Customers: All products at the end of their life must be returned to Zebra for recycling. For information on how to return product, please go to: <http://www.zebra.com/weee>.

**Français :** Clients de l'Union Européenne : Tous les produits en fin de cycle de vie doivent être retournés à Zebra pour recyclage. Pour de plus amples informations sur le retour de produits, consultez : <http://www.zebra.com/weee>.

**Español:** Para clientes en la Unión Europea: todos los productos deberán entregarse a Zebra al final de su ciclo de vida para que sean reciclados. Si desea más información sobre cómo devolver un producto, visite: <http://www.zebra.com/weee>.

**Bulgarian:** За клиенти от ЕС: След края на ползения им живот всички продукти трябва да се връщат на Zebra за рециклиране. За информация относно връщането на продукти, моля отидете на адрес: <http://www.zebra.com/weee>.

**Deutsch:** Für Kunden innerhalb der EU: Alle Produkte müssen am Ende ihrer Lebensdauer zum Recycling an Zebra zurückgesandt werden. Informationen zur Rücksendung von Produkten finden Sie unter <http://www.zebra.com/weee>.

**Italiano:** per i clienti dell'UE: tutti i prodotti che sono giunti al termine del rispettivo ciclo di vita devono essere restituiti a Zebra al fine di consentirne il riciclaggio. Per informazioni sulle modalità di restituzione, visitare il seguente sito Web: <http://www.zebra.com/weee>.

**Português:** Para clientes da UE: todos os produtos no fim de vida devem ser devolvidos à Zebra para reciclagem. Para obter informações sobre como devolver o produto, visite: <http://www.zebra.com/weee>.

**Nederlands:** Voor klanten in de EU: alle producten dienen aan het einde van hun levensduur naar Zebra te worden teruggezonden voor recycling. Raadpleeg <http://www.zebra.com/weee> voor meer informatie over het terugzenden van producten.

**Polski:** Klienci z obszaru Unii Europejskiej: Produkty wycofane z eksploatacji należą ywrócić do firmy Zebra w celu ich utylizacji. Informacje na temat zwrotu produktów znajdują\* się na stronie internetowej <http://www.zebra.com/weee>.

**Čeština:** Pro zákazníky z EU: Všechny produkty je nutné po skončení jejich životnosti vrátit společnosti Zebra k recyklaci. Informace o způsobu vrácení produktu najdete na webové stránce: <http://www.zebra.com/weee>.

**Eesti:** EL klientidele: kõik tooted tuleb nende eluea lõppedes tagastada taaskasutamise eesmärgil Zebra'ile. Lisainformatsiooni saamiseks toote tagastamise kohta külastage palun aadressi: <http://www.zebra.com/weee>.

**Magyar:** Az EU-ban vásárlóknak: Minden tönkrement terméket a Zebra vállalathoz kell eljuttatni újrahasznosítás céljából. A termék visszajuttatásának módjával kapcsolatos tudnivalóért látogasson el a <http://www.zebra.com/weee> weboldalra.

**Slovenski:** Za kupce v EU: vsi izdelki se morajo po poteku življenjske dobe vrniti podjetju Zebra za reciklažo. Za informacije o vračilu izdelka obiščite: <http://www.zebra.com/weee>.

**Svenska:** För kunder inom EU: Alla produkter som uppnått sin livslängd måste returneras till Zebra för återvinning. Information om hur du returnerar produkten finns på <http://www.zebra.com/weee>.

**Suomi:** Asiakkaat Euroopan unionin alueella: Kaikki tuotteet on palautettava kierrätettäväksi Zebra-yhtiöön, kun tuotetta ei enää käytetä. Lisätietoja tuotteen palauttamisesta on osoitteessa <http://www.zebra.com/weee>.

**Dansk:** Til kunder i EU: Alle produkter skal returneres til Zebra til recirkulering, når de er udtjent. Læs oplysningerne om returnering af produkter på: <http://www.zebra.com/weee>.

**Ελληνικά:** Για πελάτες στην Ε.Ε.: Όλα τα προϊόντα, στο τέλος της διάρκειας ζωής τους, πρέπει να επιστρέφονται στην Zebra για ανακύκλωση. Για περισσότερες πληροφορίες σχετικά με την επιστροφή ενός προϊόντος, επισκεφθείτε τη διεύθυνση <http://www.zebra.com/weee> στο Διαδίκτυο.

**Malti:** Għal klijenti fl-UE: il-prodotti kollha li jkunu waslu fl-aħħar tal-hajja ta' l-użu tagħhom, iridu jiġu rritornati għand Zebra għar-riciklaġġ. Għal aktar taġġrif dwar kif għandek tirritorna l-prodott, jekk jogħġbok zur: <http://www.zebra.com/weee>.

**Slovenščina:** Pre zăkaznikov z krajín EU: Všetky výrobky musia byť po uplynutí doby ich životnosti vrátené spoločnosti Zebra na recykláciu. Bližšie informácie o vrátení výrobkov nájdete na: <http://www.zebra.com/weee>.

**Lietuvių:** ES vartotojams: visi gaminiai, pasibaigus jų eksploatacijos laikui, turi būti gražinti utilizuoti į kompaniją „Zebra“. Daugiau informacijos, kaip gražinti gaminį, rasite: <http://www.zebra.com/weee>.

**Latviešu:** ES klientiem: visi produkti pēc to kalpošanas mūža beigām ir jānogādā atpakaļ Zebra otrreizējai pārstrādei. Lai iegūtu informāciju par produktu nogādāšanu Zebra, lūdzu, skatiet: <http://www.zebra.com/weee>.

**Türkçe:** AB Müşterileri için: Kullanım süresi dolan tüm ürünler geri dönüşürme için Zebra'ya iade edilmelidir. Ürünlerin nasıl iade edileceği hakkında bilgi için lütfen şu adresi ziyaret edin: <http://www.zebra.com/weee>.

**Hrvatski:** Za kupce u Europskoj uniji: Svi se proizvodi po isteku vijeka trajanja moraju vratiti tvrtki Zebra na recikliranje. Informacije o načinu vraćanja proizvoda potražite na web-stranici: [www.zebra.com/weee](http://www.zebra.com/weee).

## Wall Mount Template

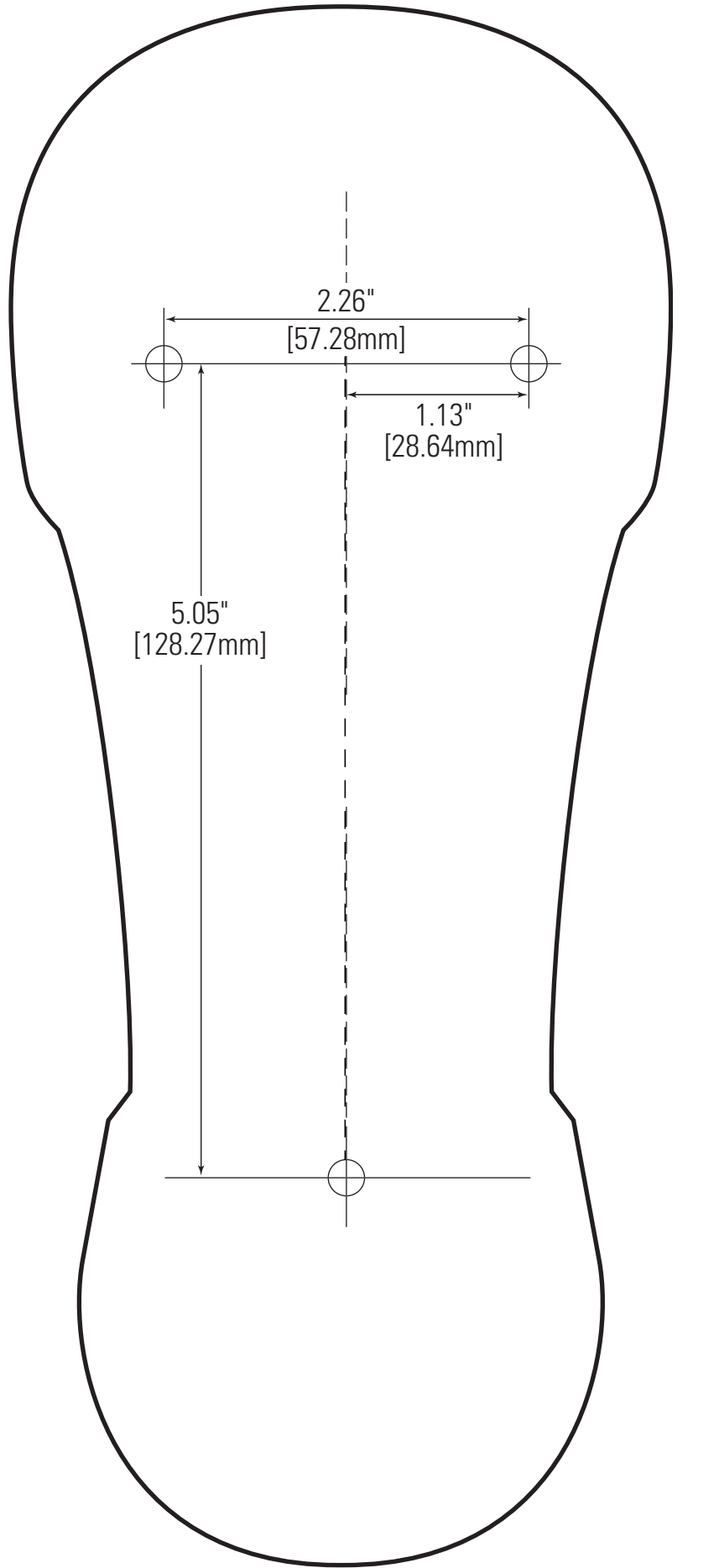

Dimension tolerance = ± 0.01 inch (± 0.25 mm)