

 **DATALOGIC**

# Gryphon™ GFS41XX

Fixed Mount Linear Imager  
Bar Code Reader



**Quick Reference Guide**

**Datalogic ADC, Inc.**

959 Terry Street  
Eugene, OR 97402  
USA

Telephone: (541) 683-5700

Fax: (541) 345-7140

©2010-2014 Datalogic ADC, Inc.

An Unpublished Work - All rights reserved. No part of the contents of this documentation or the procedures described therein may be reproduced or transmitted in any form or by any means without prior written permission of Datalogic ADC, Inc. or its subsidiaries or affiliates ("Datalogic" or "Datalogic ADC"). Owners of Datalogic products are hereby granted a non-exclusive, revocable license to reproduce and transmit this documentation for the purchaser's own internal business purposes. Purchaser shall not remove or alter any proprietary notices, including copyright notices, contained in this documentation and shall ensure that all notices appear on any reproductions of the documentation.

Should future revisions of this manual be published, you can acquire printed versions by contacting your Datalogic representative. Electronic versions may either be downloadable from the Datalogic website ([www.datalogic.com](http://www.datalogic.com)) or provided on appropriate media. If you visit our website and would like to make comments or suggestions about this or other Datalogic publications, please let us know via the "Contact Datalogic" page.

### Disclaimer

Datalogic has taken reasonable measures to provide information in this manual that is complete and accurate, however, Datalogic reserves the right to change any specification at any time without prior notice.

Datalogic and the Datalogic logo are registered trademarks of Datalogic S.p.A. in many countries, including the U.S.A. and the E.U. All other brand and product names may be trademarks of their respective owners.

### Patents

This product is covered by one or more of the following patents.

US Pat.: 5,311,000; 5,481,098; 5,929,421; 5,992,740; 6,098,883; 6,260,764;  
6,443,360 B1; 6,808,114 B1; 6,997,385 B2; 7,075,663 B2; 7,387,246 B2.

European Pat.: 789,315 B1; 926,620 B1; 997,760 B1; 1,128,315 B1; 1,217,571 B1;  
1,396,811 B1; 1,413,971 B1; 1,804,089 B1.

Chinese Pat.: CN ZL200680050007,8

Additional patents pending.

# Table of Contents

Setting Up the Reader .....	6
Select Interface - USB Interface .....	6
Mounting Bracket .....	8
Programming .....	10
Operating Modes .....	10
Exposure Modes .....	11
Technical Features .....	12
RS-232 Electrical Connections .....	15
LED and Beeper Indications .....	17
Button and LED Status .....	17
Ergonomic Recommendations .....	18
Regulatory Information .....	19
Reader Labeling .....	19
China RoHS Statement .....	20
WEEE Statement .....	21
Datalogic ADC Limited Factory Warranty .....	22
Ergonomic Recommendations .....	24
Services and Support .....	25

---

# NOTES

---

**Datalogic ADC, Inc.**  
**GRYPHON™ PRODUCT SERIES END USER LICENSE AGREEMENT**

**Notice to End User: The Datalogic Product you have acquired contains embedded Software, which is integral to the product's operation. This Software is being provided to you under license, subject to the terms and conditions of this Agreement. If you use the Datalogic Product, you will be deemed to have accepted the terms and conditions of this Agreement. If you do not intend to be bound to the terms of this Agreement, Datalogic is not willing to license the Software to you, you may not use the Datalogic Product or the Software, and you must contact the party from whom you acquired the Datalogic Product for instructions.**

This End User Software License Agreement ("Agreement") is a legally binding agreement governing the licensing of the Software and Documentation by Datalogic ADC, Inc. and its Affiliates ("Datalogic") to the entity or person who has purchased or otherwise acquired a Datalogic Product ("End User"). For purposes of this Agreement, any software that is associated with a separate end-user license agreement is licensed to you under the terms of that license agreement. Datalogic and End User hereby agree as follows:

### **1. Definitions.**

- 1.1 "Affiliate" means a business entity currently existing or later acquired that controls, is controlled by, or is under common control with Datalogic S.p.A.
- 1.2 "Documentation" means materials such as user's guides, program reference guides, quick reference guides, manuals, or similar materials associated with or related to the Datalogic Product, whether in printed, "online", or other form.
- 1.3 "Proprietary Information" means: (a) source code, object code, software, documentation, and any related internal design, system design, data base design, algorithms, technology, technical data or information, implementation techniques, and trade secrets related to the Software, (b) any other trade secrets marked appropriately or identified as proprietary or confidential, and (c) any information that End User, under the circumstances, should recognize as confidential. Proprietary Information does not include any information that the receiving party can establish was (1) in the public domain, (2) already in the receiving party's possession or rightfully known prior to receipt, (3) rightfully learned from a third party not in violation of any other's proprietary rights, or (4) independently developed without access to Proprietary Information.
- 1.4 "Datalogic Product" means the Datalogic® Gryphon™ series scanner product, including all embedded Software in and all Documentation related to such product, which has been purchased or otherwise acquired by End User, whether obtained directly or indirectly from Datalogic.
- 1.5 "Software" means any software or computer programs of Datalogic or its third party licensors in machine readable form which is embedded in the Datalogic Product, whether obtained directly or indirectly from Datalogic, including any replacement, update, upgrade, enhancement or modification.

### **2. Scope Of License Granted.**

- 2.1 Datalogic grants to End User a non-exclusive, non-transferable, perpetual license to use the Software, solely on the Datalogic Product in which it is embedded ("designated Datalogic Product"), in machine-readable form only, solely for End User's internal business purposes. This Agreement does not convey ownership of the Software to End User. Title to the Software shall be and remain with Datalogic or the third party from whom Datalogic has obtained a licensed right. As used in this Agreement, the term "purchase" or its equivalents when applied to the Software shall mean "acquire under license." End User is not entitled to receipt or use of the source code to any Software.
- 2.2 End User shall not copy, modify, decompile, disassemble, reverse engineer, or otherwise reproduce or remanufacture the Software, whether modified or unmodified, nor sell, assign, sublicense, distribute, lend, rent, give, or otherwise transfer the Software to any other person or organization, for purposes other than as expressly provided in this Agreement, without

---

Datalogic's prior written consent.

### **3. Transfers, Support.**

- 3.1 Any copying, installing, reproduction, remanufacture, reverse engineering, electronic transfer, or other use of the Software on other than the designated Datalogic Product will be a material breach of this Agreement. However, Datalogic may elect not to terminate this Agreement or the granted licenses, but instead may elect to notify End User that End User is deemed to have ordered and accepted a license for each breaching use. End User shall pay Datalogic the applicable list price for such licenses as of the date of such breach.
- 3.2 End User shall not sell, assign, sublicense, distribute, lend, rent, give, or otherwise transfer the Datalogic Product to any third party unless such third party agrees with Datalogic in writing to be bound by the terms and conditions of this Agreement. Any such transfer of the Datalogic Product absent such agreement shall be null and void.
- 3.3 End User may obtain support for Software from Datalogic at Datalogic's standard support fees and under Datalogic's standard support terms and conditions in effect at the time the support is requested.

### **4. Intellectual Property.**

End User acknowledges that the Software constitutes valuable trade secrets of Datalogic or Datalogic's third party licensors and that the Software is protected by intellectual property laws and treaties. The license set forth in this Agreement does not transfer to End User any ownership of Datalogic's or its third party licensors' copyrights, patents, trademarks, service marks, trade secrets, or other intellectual property rights and End User shall have no right to commence any legal actions to obtain such rights. End User shall not remove, modify, or take any other action that would obscure any copyright, trademark, patent marking, or other intellectual property notices contained in or on the Datalogic Product.

### **5. Proprietary Information.**

- 5.1 End User acknowledges that Proprietary Information is the confidential, proprietary, and trade secret property of Datalogic and Datalogic's third party licensors and End User acquires no right or interest in any Proprietary Information.
- 5.2 End User shall not disclose, provide, or otherwise make available the Proprietary Information of Datalogic or its third party licensors to any person other than End User's authorized employees or agents who are under confidentiality agreement, and End User shall not use the Proprietary Information other than in conjunction with use of the Datalogic Product exclusively for End User's internal business purposes. End User shall take steps to protect the Proprietary Information no less securely than if it were End User's own intellectual property.
- 5.3 The provisions of this Proprietary Information Section shall survive and continue for five (5) years after the termination of this Agreement.

### **6. Limited Warranty.**

- 6.1 Datalogic warrants that, under normal use and operation, the Datalogic Product will conform substantially to the applicable Documentation for the period specified in the Documentation. During this period, for all reproducible nonconformities for which Datalogic has been given written notice, Datalogic will use commercially reasonable efforts to remedy nonconformities verified by Datalogic. End User agrees to supply Datalogic with all reasonably requested information and assistance necessary to help Datalogic in remedying such nonconformities. For all defects reported to Datalogic within the warranty period, Datalogic's liability is limited to providing End User with one copy of corrections or responding to End User's problem reports according to Datalogic's standard assistance practices. Datalogic does not warrant that the product will meet End User's requirements or that use of the product will be uninterrupted or error free, or that Datalogic's remedial efforts will correct any nonconformance. This limited warranty does not cover any product that have been subjected to damage or abuse, whether intentionally, accidentally, or by neglect, or to unauthorized repair or unauthorized installation, and shall be void if End User modifies the product, uses the product in any manner other than as established in the Documentation, or if End User breaches any of the provisions of this

---

Agreement.

- 6.2 EXCEPT AS PROVIDED IN THIS AGREEMENT, THE DATALOGIC PRODUCT IS PROVIDED "AS IS" AND DATALOGIC MAKES NO WARRANTIES OF ANY KIND, EXPRESS OR IMPLIED, WRITTEN OR ORAL, WITH RESPECT TO THE PRODUCT, AND SPECIFICALLY DISCLAIMS THE IMPLIED WARRANTIES OF MERCHANTABILITY AND FITNESS FOR A PARTICULAR PURPOSE.

## **7. Infringement.**

- 7.1 Datalogic will defend End User against any claim in a lawsuit that the Datalogic Product furnished hereunder infringe a United States patent or copyright of a third party and Datalogic will pay any damages finally awarded against End User by a court of competent jurisdiction that are attributable to such claim or will pay End User's part of any settlement that is attributable to such claim, provided, that 1) End User notifies Datalogic promptly in writing of the claim, 2) Datalogic controls the defense or settlement of the claim, and 3) End User cooperates fully with Datalogic in such defense or settlement. All notices of a claim should be sent to Datalogic ADC, Inc., Legal Department, 959 Terry Street, Eugene, OR 97402.
- 7.2 In the defense or settlement of any such claim, Datalogic may, at its option, 1) procure for End User the right to continue using the Datalogic Product, 2) modify the Datalogic Product so that it becomes non-infringing, 3) replace the Datalogic Product with an equivalent product not subject to such claim, or 4) provide End User an opportunity to return the Datalogic Product and receive a refund of the purchase price paid, less a reasonable allowance for use.
- 7.3 Datalogic shall have no liability to End User for claims of infringement based upon 1) the use of any Datalogic Product in combination with any product which Datalogic has not either furnished or authorized for use with such Datalogic Product 2) the use of any Datalogic Product designed, manufactured, or modified to the specifications of End User, or 3) End User's modification of the Datalogic Product without written authorization from Datalogic.
- 7.4 THE FOREGOING STATES DATALOGIC'S COMPLETE AND ENTIRE OBLIGATION CONCERNING CLAIMS OF PATENT, COPYRIGHT, OR OTHER INTELLECTUAL PROPERTY INFRINGEMENT, CANCELS AND SUPERCEDES ANY PRIOR AGREEMENTS, WHETHER ORAL OR WRITTEN, BETWEEN THE PARTIES CONCERNING SUCH CLAIMS, AND WILL NOT BE MODIFIED OR AMENDED BY ANY PAST, CONTEMPORANEOUS, OR FUTURE AGREEMENTS OR DEALINGS BETWEEN THE PARTIES, WHETHER ORAL OR WRITTEN, EXCEPT AS SET FORTH IN A FUTURE WRITING SIGNED BY BOTH PARTIES.

## **8. Limitation Of Liability.**

EXCEPT AS PROVIDED IN SECTION 7, DATALOGIC SHALL NOT BE LIABLE FOR ANY CLAIMS AGAINST END USER BY ANY OTHER PARTY. IN NO EVENT SHALL DATALOGIC'S LIABILITY FOR DAMAGES, IF ANY, WHETHER BASED UPON CONTRACT, TORT (INCLUDING NEGLIGENCE), PRODUCT LIABILITY, STRICT LIABILITY, WARRANTY, OR ANY OTHER BASIS, EXCEED THE PRICE OR FEE PAID BY END USER FOR THE DATALOGIC PRODUCT. UNDER NO CIRCUMSTANCES SHALL DATALOGIC BE LIABLE TO END USER OR ANY THIRD PARTY FOR LOST PROFITS, LOST DATA, INTERRUPTION OF BUSINESS OR SERVICE, OR FOR ANY OTHER SPECIAL, CONSEQUENTIAL, CONTINGENT, INDIRECT, INCIDENTAL, PUNITIVE, EXEMPLARY, OR OTHER SIMILAR DAMAGES, EVEN IF DATALOGIC HAS BEEN ADVISED OF THE POSSIBILITY OF SUCH DAMAGES.

## **9. Government Restricted Rights; International Use.**

- 9.1 Use, duplication, or disclosure of the Software by the U.S. Government is subject to the restrictions for computer software developed at private expense as set forth in the U.S. Federal Acquisition Regulations at FAR 52.227-14(g), or 52.227-19 or in the Rights in Technical Data and Computer Software clause at DFARS 252.227-7013(c)(1)(ii), whichever is applicable.
- 9.2 If End User is using the Datalogic Product outside of the United States, End User must comply with the applicable local laws of the country in which the Datalogic Product is used, with U.S. export control laws, and with the English language version of this Agreement. The provisions of the "United Nations Convention on International Sale of Goods" shall not apply to this Agreement.

---

## 10. Termination.

- 10.1 Either party may terminate this Agreement or any license granted under this Agreement at any time upon written notice if the other party breaches any provision of this Agreement.
- 10.2 Upon termination of this Agreement, End User immediately shall cease using any nonembedded software and shall return to Datalogic or destroy all non-embedded software covered by this Agreement, and shall furnish Datalogic with a certificate of compliance with this provision signed by an officer or authorized representative of End User. For embedded software, End User agrees to sign a waiver prepared by Datalogic concerning further use of the embedded Software. End User's resumed or continued use of the embedded Software after termination shall constitute End User's agreement to be bound by the terms and conditions of this Agreement for such use.

## 11. General Provisions.

- 11.1 Entire Agreement; Amendment. This document contains the entire agreement between the parties relating to the licensing of the Software and supersedes all prior or contemporaneous agreements, written or oral, between the parties concerning the licensing of the Software. This Agreement may not be changed, amended, or modified except by written document signed by Datalogic.
- 11.2 Notice. All notices required or authorized under this Agreement shall be given in writing, and shall be effective when received, with evidence of receipt. Notices to Datalogic shall be sent to the attention of Contract Administration, Datalogic ADC, Inc., 959 Terry Street, Eugene, OR 97402, or such other address as may be specified by Datalogic in writing.
- 11.3 Waiver. A party's failure to enforce any of the terms and conditions of this Agreement shall not prevent the party's later enforcement of such terms and conditions.
- 11.4 Governing Law; Venue: This Agreement and the rights of the parties hereunder shall be governed by and construed in accordance with the laws of the State of Oregon U.S.A, without regard to the rules governing conflicts of law. The state or federal courts of the State of Oregon located in either Multnomah or Lane counties shall have exclusive jurisdiction over all matters regarding this Agreement, except that Datalogic shall have the right, at its absolute discretion, to initiate proceedings in the courts of any other state, country, or territory in which End User resides, or in which any of End User's assets are located.
- 11.5 Attorneys' Fees. In the event an action is brought to enforce the terms and conditions of this Agreement, the prevailing party shall be entitled to reasonable attorneys' fees, both at trial and on appeal.

- END -

### Software Product Policy

Datalogic reserves the right to ship its products with the latest version of software/firmware available. This provides our customers with the very latest in Datalogic software technology.

The only exception to this policy is when the buyer has a signed contract with Datalogic that clearly defines the terms and conditions for making software/firmware changes in products shipped to the buyer.

### Customers Under Software Support

Customers that elect to subscribe to Datalogic Software Maintenance and Support Agreement will receive 30 days advance notification of: (1) the release of a new software version; and/or (2) discontinuation of any prior software version that will no longer be supported. Datalogic will provide maintenance for a fee that will assist customers in transitioning to the next software version. If a customer is currently using the software version being discontinued, the customer may elect to transition to any one of the newer versions, depending on the hardware in use.

To arrange for a Software Maintenance and Support Agreement please contact your Datalogic sales person.



# Gryphon GFS4XXX

## Fixed Mount Linear Imager

### Bar Code Reader

The Gryphon GFS4XXX is a fully self-contained standard range 1D bar code scanning module for use in self service kiosks or other semi automated equipment requiring the ability to read a bar code. It is intended to be an easy integration by system designers with little expertise in scanning technology. Unlike currently available products, the GFS4XXX uses the latest and fastest imaging technology and offers Datalogic's Green Spot for targeting and good read feedback.

The scanning technology is essentially the same as the Gryphon I 4100 family of linear imagers, with some adjustments made for read range and improved motion tolerance. The enclosure is designed for ease of integration, is sealed to IP54 for cleaning, and is constructed of a solvent- and disinfectant-tolerant resin for health care applications.

The GFS4XXX is a linear CCD Scanner for OEM applications. It is available in two different models:

- GFS4170 Gryphon Fixed Scanner imager USB
- GFS4150-9 Gryphon Fixed Scanner imager RS-232 9 pin connector

---

## Setting Up the Reader

### Select Interface - USB Interface

The reader (GFS4170 model only) attaches directly to a USB host or a powered USB hub, and is powered by it. No additional power supply is required. The reader auto-detects the USB and defaults to the HID keyboard interface.

To simulate a Keyboard, scan the bar code below:

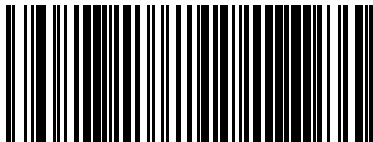

Interface Selection: USB-KBD (GFS4170 model only)

To simulate an RS-232 Standard Interface scan the bar code below:

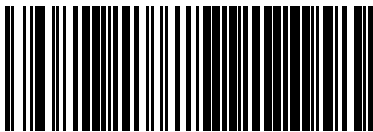

Interface Selection: USB-COM (GFS4170 Model only)



**IMPORTANT**

**Download the correct USB COM driver from:  
<http://www.datalogic.com>.**

Select USB Keyboard with alternate key encoding:

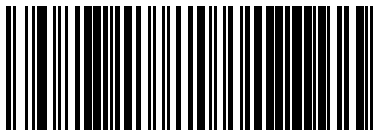

USB Alternate Keyboard

Select USB Keyboard for Apple computers:

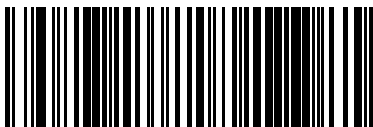

USB-KBD-APPLE

Select RS-232 Wincor-Nixdorf:

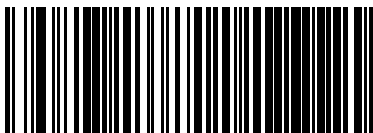

RS-232 Wincor-Nixdorf

## Mounting Bracket

The GFS4XXX can be mounted to a stationary surface using a bracket as shown below. Just attach to the bottom of the reader using screws, as shown in the next two figures.

**Figure 1. Mounting the bracket**

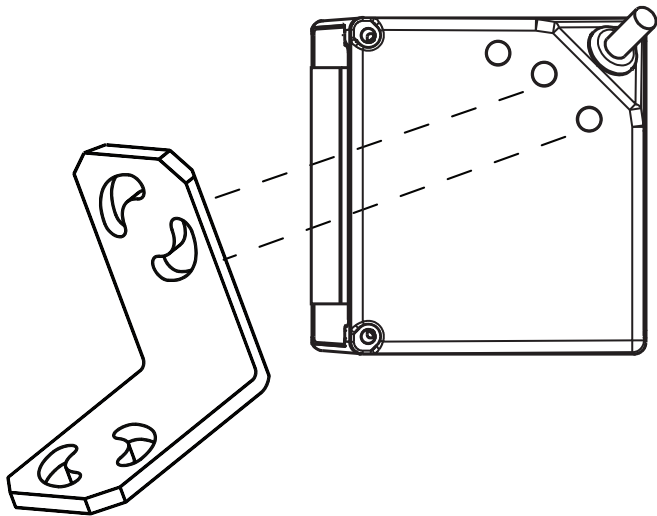

**Figure 2. Bracket Attached**

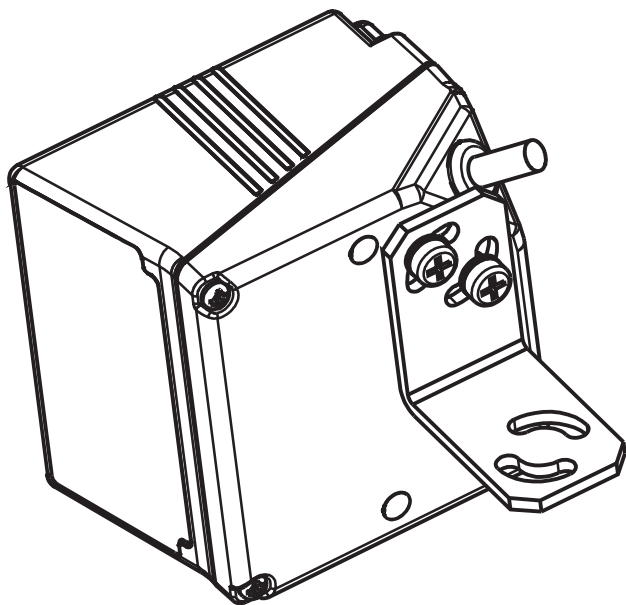

---

## Programming

For your convenience, this guide includes the programming bar codes required to configure the reader.

If you aren't sure what programming options are in your reader, or you've changed some options and want the factory settings restored, scan the bar code below:



Restore Default Settings

## Operating Modes

The reader can operate in one of several scanning modes:

**On Line** — Scanning is activated when the button is pushed or through an external trigger (GFS4150-9 only).

**Automatic** — Scanning is continually on.

**Automatic (Object Sense)** — Scanning is turned on automatically when an item is placed in reader's field of view.

**Strobe Exposure Mode** — For any selectable scanning mode, performance on moving bar codes can be improved by flashing the scanner's lighting (strobe mode). The scanner strobes at a very high frequency, so the change in lighting may not be apparent. When enabled, the scanner can read codes moving at up to 1m/sec, depending on the bar size and direction the code is moving.

---

## Operating Modes (continued)



Operating Mode = On Line

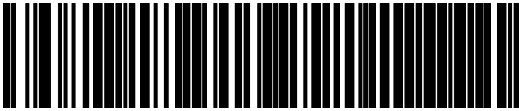

Operating Mode = Automatic

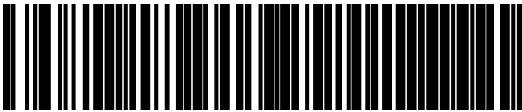

Operating Mode = Automatic (Object Sense)

## Exposure Modes

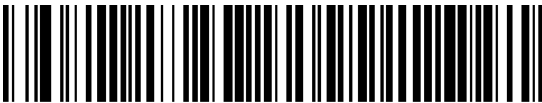

Continuous



Strobed

## Technical Features

Item	Description
<b>Physical Characteristics</b>	
Color	Grey
Dimensions	Height 1.54" / 39mm Length 2.24" / 57mm Width 2.28" / 58 mm
Weight (without brackets)	USB model - Approx. 5.0 ounces/140 g RS-232 model - approx. 6.0 ounces/170 g
<b>Electrical Characteristics</b>	
Input Voltage	5 VDC $\pm$ 5%
<b>External Trigger Input</b> (Only GFS4150-9)	
Voltage	5 $\div$ 30 VDC
Current Consumption	10 mA max
Minimum Pulse Duration	5 ms
<b>Output</b> (Only GFS4150-9)	
Vce	30 Vdc max
Collector Current	40 mA continuous max.
Vce Saturation	1V max at 10 mA
Power Dissipation	80 mW max at 50 °C (ambient temperature)
Current & Power Consumption	Input current at 5V = 390 mA (max) <2.5 mA (GFS4170 model in USB suspend)



Item	Description
<b>Performance Characteristics</b>	
Scan rate	320 scans/s (max)
Light Source	Dual LEDs (Red Light, =620 nm)
Roll Angle Tolerance	± 35°
Pitch Angle Tolerance	± 65° (Avoid zero angle, ± 6°)
Skew Angle Tolerance	± 65°
Depth of Field (Typical)	5 mil - 2" to 6.3" (5cm to 16cm) 8 mil - 1.2" to 10.6" (3cm to 27cm) 13 mil* - 1.2" to 15.7" (3cm to 40 cm) 20 mil - up to 23.6" (up to 60 cm)
Minimum Element Width	3 mil
Print Contrast Minimum	15% minimum reflectance
Decode Capability	UPC/EAN/JAN A, E, 13, 8 (including P2 /P5, ISBN / Bookland & ISSN); Code 39 (including full ASCII); Code 39 CIP (French Pharmaceutical); Code 128; I 2 of 5; Standard 2 of 5; China Post Code (DLS 2 of 5); IATA Industrial 2 of 5 Air Cargo Code; Codabar; ABC Codabar; GS1 - 128; Code ISBT 128; MSI; Plessey; DATABAR-14; DATABAR Limited; DATABAR-14 Stacked; DATABAR Expanded Stacked; Code32 (Italian Pharmacode); China Post (DLS 2 of 5).
Interfaces Supported	GFS4150-9 model: RS-232 Standard GFS4170 model:USB COM Standard, USB Keyboard

Item	Description
<b>User Environment</b>	
Operative Temperature	32° to 122° F (0° to 50° C)
Storage Temperature	-13° to 158° F (-25° to 70° C)
Humidity	Operating: 5% to 90% relative humidity, non condensing
Drop specifications	5 drops from 30 inches (0.76 mt.) to concrete
Ambient Light immunity	Up to 100,000 Lux
Contaminants	IP54
ESD Level	16 KV
<b>Regulatory</b>	
LED Emission Class	(IEC-62471:2006-07) Exempt (No Risk) IEC 60825-1:1993 + A1:1997 + A2:2001
Electrical Safety	IEC 60950-1 , CAN/CSA-C22.2 No. 60950-1-03; UL 60950-1
EMI/RFI	North America (FCC) : Part 15 Class B, Canada ( IC ) : ICES-003 Class B, European Union EMC Directive, Australian (C-tick), Russia (Gost)

\* (13 mils DOF based on EAN. All others are Code 39. All labels grade A, minimum illumination 100 lux, 20°C, label inclination 10°, static reading).

## RS-232 Electrical Connections

### 9-pin connector

1	Trigger	Trigger signal input (see Figure 4 and Figure 5 on next page)
2	TX	Transmit Data
3	RX	Receive Data
4	NC	Not connected
5	GND	Ground
6	VCC	+5Vdc
7	CTS	Clear To Send
8	RTS	Request To Send
9	OUT	Output signal (see Figure 3)

Default configuration RS-232: 9600, 8, N, 1, no handshaking, ACK/NAK disabled.

**Figure 3. Output Connection**

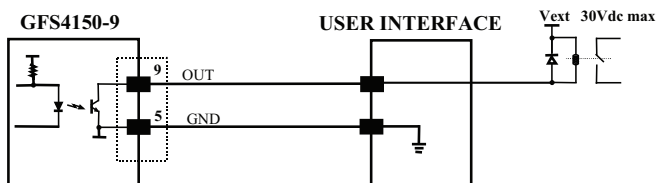

**Figure 4. Using GFS4150-9 Power**

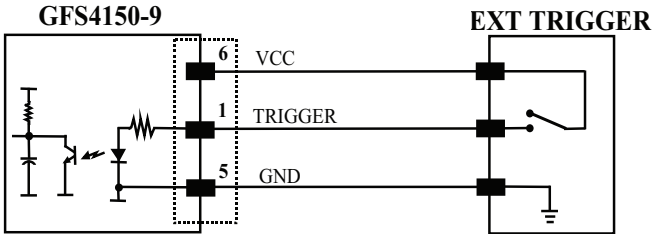

**Figure 5. Using External Power Supply**

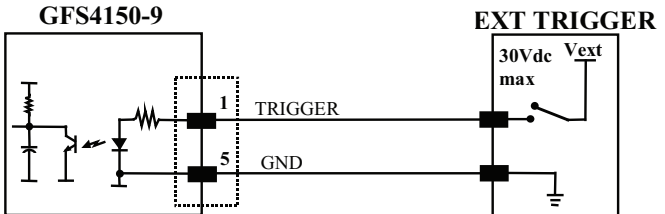

# LED and Beeper Indications

## Button and LED Status

The top of the product has a button and three indicator LEDs:

	POWER (yellow LED)	ON = Power ON
		OFF = Power OFF or standby (only USB model)
	GOOD (green LED)	ON = Good Read
		Blinks = USB enumeration or interface inactive or waiting for change of configuration
TRIGGER (blue LED)	ON = external trigger or button pressed or phase active	
Button	Press for manual trigger	

## Ergonomic Recommendations



**CAUTION** In order to avoid or minimize the potential risk of ergonomic injury follow the recommendations below. Consult with your local Health & Safety Manager to ensure that you are adhering to your company's safety programs to prevent employee injury.

- Reduce or eliminate repetitive motion
- Maintain a natural position
- Reduce or eliminate excessive force
- Keep objects that are used frequently within easy reach
- Perform tasks at correct heights
- Reduce or eliminate vibration
- Reduce or eliminate direct pressure
- Provide adjustable workstations
- Provide adequate clearance
- Provide a suitable working environment
- Improve work procedures.

## Regulatory Information

All models are designed to be compliant with rules and regulations in locations they are sold and will be labeled as required.

Any changes or modifications to equipment not expressly approved by Datalogic could void the user's authority to operate the equipment.

## Reader Labeling

Sample labels are shown for illustrative purposes only. Please view the labels on your product for actual details, as they may vary.

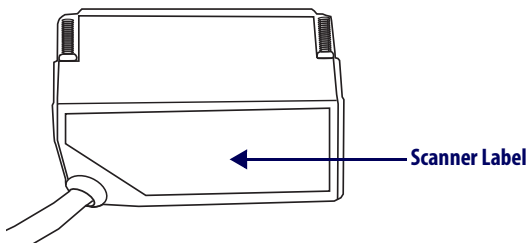

## China RoHS Statement



## China RoHS

PART	部件名称	Lead (Pb)	Mercury (Hg)	Cadmium (Cd)	Hexavalent Chromium (Cr(VI))	Polybrominated biphenyls (PBB)	Polybrominated diphenyl ethers (PBDE)
		铅	汞	镉	六价铬	多溴联苯	多溴二苯醚
Printed Circuit Board Assembly	电路板组件	X	0	0	0	0	0
Assy, Optics Block	光学组件	X	0	0	0	0	0
Assy, Module	光学组件	X	0	0	0	0	0

**O:** 代表此种部件的所有均质材料中所含的该种有毒有害物质均低于中华人民共和国信息产业部所颁布的《电子信息产品中有毒有害物质的限量要求》(SJ/T 11363-2006) 规定的限量。

**X:** 代表此种部件所用的均质材料中,至少有一类材料其所含的有毒有害物质高于中华人民共和国信息产业部所颁布的《电子信息产品中有毒有害物质的限量要求》(SJ/T 11363-2006) 规定的限量。



850000870

RoHS TABLE:CHINA

REV. C



---

## WEEE Statement

### English

For information about the disposal of Waste Electrical and Electronic Equipment (WEEE), please refer to the website at [www.datalogic.com](http://www.datalogic.com).

### Italian

Per informazioni sullo smaltimento delle apparecchiature elettriche ed elettroniche consultare il sito Web [www.datalogic.com](http://www.datalogic.com).

### French

Pour toute information relative à l'élimination des déchets électroniques (WEEE), veuillez consulter le site internet [www.datalogic.com](http://www.datalogic.com).

### German

Informationen zur Entsorgung von Elektro- und Elektronik- Altgeräten (WEEE) erhalten Sie auf der Webseite [www.datalogic.com](http://www.datalogic.com).

### Spanish

Si desea información acerca de los procedimientos para el desecho de los residuos del equipo eléctrico y electrónico (WEEE), visite la página Web [www.datalogic.com](http://www.datalogic.com).

### Portuguese

Para informações sobre a disposição de Sucatagem de Equipamentos Elétricos e Eletrônicos (WEEE -Waste Electrical and Electronic Equipment), consultar o site web [www.datalogic.com](http://www.datalogic.com).

### Chinese

有关处理废弃电气电子设备 (WEEE) 的信息, 请参考 Datalogic 公司的网站 [www.datalogic.com/](http://www.datalogic.com/)。

### Japanese

廃電気電子機器 (WEEE) の処理についての関連事項は Datalogic のサイト [www.datalogic.com](http://www.datalogic.com) をご参照下さい。

---

# Datalogic ADC Limited Factory Warranty

## Warranty Coverage

Datalogic warrants to Customer that Datalogic's products will be free from defects in materials and workmanship for a period of one (1) year from product shipment. Datalogic ADC ("Datalogic") hardware products are warranted against defects in material and workmanship under normal and proper use. The liability of Datalogic under this warranty is limited to furnishing the labor and parts necessary to remedy any defect covered by this warranty and restore the product to its normal operating condition. Repair or replacement of product during the warranty does not extend the original warranty term. Products are sold on the basis of specifications applicable at the time of manufacture and Datalogic has no obligation to modify or update products once sold.

If Datalogic determines that a product has defects in material or workmanship, Datalogic shall, at its sole option repair or replace the product without additional charge for parts and labor, or credit or refund the defective products duly returned to Datalogic. To perform repairs, Datalogic may use new or reconditioned parts, components, subassemblies or products that have been tested as meeting applicable specifications for equivalent new material and products. Customer will allow Datalogic to scrap all parts removed from the repaired product. The warranty period shall extend from the date of shipment from Datalogic for the duration published by Datalogic for the product at the time of purchase (Warranty period). Datalogic warrants repaired hardware devices against defects in workmanship and materials on the repaired assembly for a 90 day period starting from the date of shipment of the repaired product from Datalogic or until the expiration of the original warranty period, whichever is longer. Datalogic does not guarantee, and it is not responsible for, the maintenance of, damage to, or loss of configurations, data, and applications on the repaired units and at its sole discretion can return the units in the "factory default" configuration or with any software or firmware update available at the time of the repair (other than the firmware or software installed during the manufacture of the product). Customer accepts responsibility to maintain a back up copy of its software and data.

## Warranty Claims Process

In order to obtain service under the Factory Warranty, Customer must notify Datalogic of the claimed defect before the expiration of the applicable Warranty period and obtain from Datalogic a return authorization number (RMA) for return of the product to a designated Datalogic service center. If Datalogic determines Customer's claim is valid, Datalogic will repair or replace product without additional charge for parts and labor. Customer shall be responsible for packaging and shipping the product to the designated Datalogic service center, with shipping charges prepaid. Datalogic shall pay for the return of the product to Customer if the shipment is to a location within

the country in which the Datalogic service center is located. Customer shall be responsible for paying all shipping charges, duties, taxes, and any other charges for products returned to any other locations. Failure to follow the applicable RMA policy, may result in a processing fee. Customer shall be responsible for return shipment expenses for products which Datalogic, at its sole discretion, determines are not defective or eligible for warranty repair.

## Warranty Exclusions

The Datalogic Factory Warranty shall not apply to:

- (i) any product which has been damaged, modified, altered, repaired or upgraded by other than Datalogic service personnel or its authorized representatives;
- (ii) any claimed defect, failure or damage which Datalogic determines was caused by faulty operations, improper use, abuse, misuse, wear and tear, negligence, improper storage or use of parts or accessories not approved or supplied by Datalogic;
- (iii) any claimed defect or damage caused by the use of product with any other instrument, equipment or apparatus;
- (iv) any claimed defect or damage caused by the failure to provide proper maintenance, including but not limited to cleaning the upper window in accordance with product manual;
- (v) any defect or damage caused by natural or man-made disaster such as but not limited to fire, water damage, floods, other natural disasters, vandalism or abusive events that would cause internal and external component damage or destruction of the whole unit, consumable items;
- (vi) any damage or malfunctioning caused by non-restoring action as for example firmware or software upgrades, software or hardware reconfigurations etc.;
- (vii) the replacement of upper window/cartridge due to scratching, stains or other degradation and/or
- (viii) any consumable or equivalent (e.g., cables, power supply, batteries, key-pads, touch screen, triggers etc.).

## No Assignment

Customer may not assign or otherwise transfer its rights or obligations under this warranty except to a purchaser or transferee of product. No attempted assignment or transfer in violation of this provision shall be valid or binding upon Datalogic.

DATALOGIC'S LIMITED WARRANTY IS IN LIEU OF ALL OTHER WARRANTIES, EXPRESS OR IMPLIED, ORAL OR WRITTEN, STATUTORY OR OTHERWISE, INCLUDING, WITHOUT LIMITATION, ANY IMPLIED WARRANTIES OF MERCHANTABILITY, FITNESS FOR A PAR-

TICULAR PURPOSE, OR NONINFRINGEMENT. DATALOGIC SHALL NOT BE LIABLE FOR ANY DAMAGES SUSTAINED BY CUSTOMER ARISING FROM DELAYS IN THE REPLACEMENT OR REPAIR OF PRODUCTS UNDER THE ABOVE. THE REMEDY SET FORTH IN THIS WARRANTY STATEMENT IS THE CUSTOMER'S SOLE AND EXCLUSIVE REMEDY FOR WARRANTY CLAIMS. UNDER NO CIRCUMSTANCES WILL DATALOGIC BE LIABLE TO CUSTOMER OR ANY THIRD PARTY FOR ANY LOST PROFITS, OR ANY INCIDENTAL, CONSEQUENTIAL IN-DIRECT, SPECIAL OR CONTINGENT DAMAGES REGARDLESS OF WHETHER DATALOGIC HAD ADVANCE NOTICE OF THE POSSIBILITY OF SUCH DAMAGES.

## Risk of Loss

Customer shall bear risk of loss or damage for product in transit to Datalogic. Datalogic shall assume risk of loss or damage for product in Datalogic's possession. In the absence of specific written instructions for the return of product to Customer, Datalogic will select the carrier, but Datalogic shall not thereby assume any liability in connection with the return shipment.

## Ergonomic Recommendations



**CAUTION**

**In order to avoid or minimize the potential risk of ergonomic injury follow the recommendations below. Consult with your local Health & Safety Manager to ensure that you are adhering to your company's safety programs to prevent employee injury.**

- Reduce or eliminate repetitive motion
- Maintain a natural position
- Reduce or eliminate excessive force
- Keep objects that are used frequently within easy reach
- Perform tasks at correct heights
- Reduce or eliminate vibration
- Reduce or eliminate direct pressure
- Provide adjustable workstations
- Provide adequate clearance
- Provide a suitable working environment
- Improve work procedures.

# Services and Support

Datalogic provides several services as well as technical support through its website. Log on to **[www.datalogic.com](http://www.datalogic.com)** and click on the links indicated for further information.

## Products

Search through the links to arrive at your product page where you can download specific **Manuals** and **Software & Utilities**, including:

- **Datalogic Aladdin™**, a multi-platform utility program that allows device configuration using a PC. It provides RS-232 interface configuration as well as configuration bar code printing.

## Service & Support

- **Technical Support** - Product documentation and programming guides and Technical Support Department in the world
- **Service Programs** - Warranty Extensions and Maintenance Agreements
- **Repair Services** - Flat Rate Repairs and Return Material Authorization (RMA) Repairs
- **Downloads** – Manuals & Documentation, Data Sheets, Product Catalogs, etc.

## Contact Us

- Information Request Form and Sales & Service Network.

# NOTES

# DATALOGIC

## DECLARATION OF CONFORMITY



Datalogic ADC Srl, Via S. Vitalino, 13  
Lippo di Calderara di Reno (BO) 40012 Italy

EC-064  
Rev.: 3  
Pag.: 1 di 1

*La presente dichiarazione di conformità è rilasciata sotto la responsabilità esclusiva di Datalogic ADC Srl per:  
This Declaration of Conformity is issued under the sole responsibility of Datalogic ADC Srl for:  
Cette déclaration de conformité est établie sous la seule responsabilité de Datalogic ADC Srl pour:  
Diese Konformitätserklärung wird unter der alleinigen Verantwortung des Datalogic ADC Srl erteilt für:  
Esta declaración de conformidad se expide bajo la exclusiva responsabilidad de Datalogic ADC Srl para:*

### GFS41xx

*e tutti i suoi modelli  
and all its models  
et tous ses modèles  
und seine Modelle  
y todos sus modelos*

*sono conformi alle Direttive del Consiglio Europeo sottoelencate:  
are in conformity with the requirements of the European Council Directives listed below:  
sont conformes aux spécifications des Directives de l'Union Européenne ci-dessous:  
den nachstehenden angeführten Direktiven des Europäischen Rats:  
cumple con los requisitos de las Directivas del Consejo Europeo, según la lista siguiente:*

**2004/108/EC EMC Directive**  
**2011/65/EC RoHS Directive**

*Basate sulle legislazioni degli Stati membri in relazione alla compatibilità elettromagnetica ed alla sicurezza dei prodotti.*

*On the approximation of the laws of Member States relating to electromagnetic compatibility and product safety.*

*Basée sur la législation des Etats membres relative à la compatibilité électromagnétique et à la sécurité des produits.*

*Über die Annäherung der Gesetze der Mitgliedsstaaten in bezug auf elektromagnetische Verträglichkeit und Produktsicherheit entsprechen.*

*Basado en la aproximación de las leyes de los Países Miembros respecto a la compatibilidad electromagnética y las Medidas de seguridad relativas al producto.*

*Questa dichiarazione è basata sulla conformità dei prodotti alle norme seguenti:  
This declaration is based upon compliance of the products to the following standards:  
Cette déclaration repose sur la conformité des produits aux normes suivantes:  
Diese Erklärung basiert darauf, daß das Produkt den folgenden Normen entspricht:  
Esta declaración se basa en el cumplimiento de los productos con las siguientes normas:*

**EN 55022 (CLASS A ITE), SEP- TEMBER 2006 + A1, 2007:** *LIMITS AND METHODS OF MEASUREMENTS OF RADIO DISTURBANCE CHARACTERISTICS OF INFORMATION TECHNOLOGY EQUIPMENT*

**EN 61000-6-2, AUGUST 2005:** *ELECTROMAGNETIC COMPATIBILITY (EMC)  
PART 6-2: GENERIC STANDARDS - IMMUNITY FOR INDUSTRIAL ENVIRONMENTS*

**EN 50581, SEPTEMBER 2012:** *TECHNICAL DOCUMENTATION FOR THE ASSESSMENT OF ELECTRICAL AND ELECTRONIC PRODUCTS WITH RESPECT TO THE RESTRICTION OF HAZARDOUS SUBSTANCES*

Lippo di Calderara,  
March 29th, 2013

Ruggero Cacioppo  
Quality & Reliability MGR - Europe



# **DATALOGIC**

[www.datalogic.com](http://www.datalogic.com)

©2010-2014 Datalogic ADC, Inc. ■ All rights reserved.  
Datalogic and the Datalogic logo are registered trademarks of Datalogic S.p.A. in many countries, including the U.S.A. and the E.U.

**Datalogic ADC, Inc.**

959 Terry Street | Eugene | OR 97402 | USA  
Telephone: (1) 541-683-5700 | Fax: (1) 541-345-7140

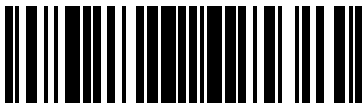

820044914

(Rev E)

June 2014