

## DC/DC Power Supply Installation Instructions

For use with the models listed below. These models can be identified by a lid with screws on the side of the lid.

**9000311PWRSPLY** – Power Supply, 9-60VDC, 60W

**9000313PWRSPLY** – Power Supply, 50-150VDC, 60W

The DC/DC power supplies above may be used to replace the following earlier model power supplies (depending on voltage range). These power supplies can be identified by a lid with screws on the top of the lid. Contact Honeywell Technical Support or go to [www.honeywellaidc.com](http://www.honeywellaidc.com) for DC/DC power supply installation instructions for the models listed below. When replacing one of these earlier power supplies, refer to **Figure 5** for information.





**VX89301PWRSPLY** – Power Supply, DC/DC, 9 to 36V

**9000301PWRSPLY** – Power Supply, 18-60VDC with cable

**VX89A302PSDC48V** – Power Supply, DC/DC, 18 to 60V

**9000302PWRSPLY** – Power Supply, 60-110VDC with cable

**VX89303PWPSPLY** – Power Supply, DC/DC, 60 to 110V

<b>Caution:</b> 	For proper and safe installation, the input power cable must be connected to a fused circuit on the vehicle. This fused circuit requires a user supplied 5 or 10 Amp maximum time delay (slow blow, see table above for fuse rating) high interrupting rating fuse. If the supply connection is made directly to the battery, the fuse should be installed in the positive lead within 5 inches of the battery positive (+) terminal.
<b>Caution:</b> 	Usage in areas where moisture can affect the power supply connections should be avoided. The power supply should be mounted in a dry location within the vehicle or placed in a suitable protective enclosure
<b>Caution:</b> 	For installation by trained service personnel only.
<b>Warning:</b> 	Risk of ignition or explosion. Explosive gas mixture may be vented from battery. Work only in well ventilated area. Avoid creating arcs and sparks at battery terminals.

### Preparing for Installation

The DC/DC power supply is used to power certain Vehicle-Mount Computers (VMCs) or to provide vehicle power to certain Hand-Held Computers (HHCs) when placed in a DC powered vehicle dock or cradle.

Specifications for electrical supply	
Input Voltage	Always observe input voltage range specified for the DC/DC power supply and the optional screen blanking box (for vehicle mounted terminals only).
Output Voltage	13.2 VDC $\pm$ 10%
Fuse	Tecton, MX9: Use a 5 A slow blow fuse.
	Thor VX8, Thor VX9, Marathon: Use a 10 A slow blow fuse
	Thor VM1, Thor VM2, Thor VM3: Use VM3055FUSE (or equivalent) to install the fuse as shown below: <ul style="list-style-type: none"> <li>• For <b>12VDC</b> input, use the 10A fuse from the kit or a slow blow fuse that has a DC voltage rating greater than 12VDC.</li> <li>• For <b>24VDC</b> input, use the 6A fuse from the kit or a slow blow fuse that has a DC voltage rating greater than 24VDC.</li> <li>• For <b>36VDC</b> input, use the 4A fuse from the kit or a slow blow fuse that has a DC voltage rating greater than 36VDC.</li> <li>• For <b>48VDC</b> input, use the 3A fuse from the kit or a slow blow fuse that has a DC voltage rating greater than 48VDC.</li> </ul>
	Screen Blanking Box: Use a 3 A fuse

Please refer to the appropriate wiring schematic on the following pages for wiring colors and connections:

**Figures 1a and 1b** – Thor VM1, Thor VM2 and Thor VM3 Vehicle Mounted Computers

**Figures 2a and 2b** – Thor VX8 and Thor VX9 Vehicle Mounted Computers

**Figure 3** – Marathon Vehicle Dock

**Figure 4** – Tecton and MX9 Vehicle Mounted Cradles

**Figure 5** – Replacing an Earlier Model Power Supply

**Figure 6** – Connecting Other Devices

**Figure 7** – Mounting Template

## Connecting to Vehicle Power

Please review the proper wiring illustration, later in this document, before beginning power cable install. If connecting a VMC, the computer must be powered off. If connecting a HHC cradle/dock, the cradle must be empty. The last connection must be to the vehicle power source.

1. Connect the power cable to the VMC or the HHC cradle.
2. Route the cable from the VMC or HHC cradle to the DC/DC power supply and, optionally for some VMCs, to the screen blanking box.
3. Cut the cable to length and strip the wire ends. If the screen blanking feature is not used for the Thor VX8 or Thor VX9, do not strip the green and yellow wires.
4. Route the power cable the shortest way possible. The cable is rated for a maximum temperature of 105°C (221°F). When routing this cable, it should be protected from physical damage and from surfaces that might exceed this temperature. Do not expose the cable to chemicals or oil that may cause the wiring insulation to deteriorate. Always route the cable so that it does not interfere with safe operation and maintenance of the vehicle.
5. Remove the lid from the DC/DC power supply.
6. Attach the stripped wire ends to the output side of the DC/DC power supply.

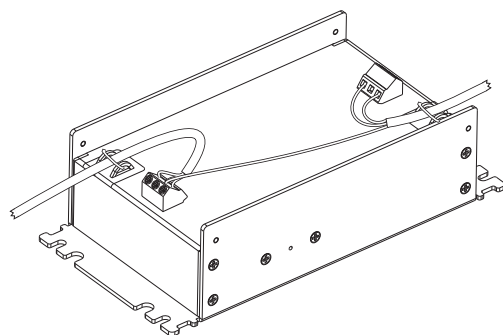

*Note: The input block has VIN+, VIN- and GND terminals. The output block has VO+ and VO- terminals. Wire colors depend on the type of device attached. Please refer to the illustrations later in this document for equipment-specific wire colors.*

7. Connect the ground wire from the VMC or HHC cradle to the GND terminal on the input side of the DC-DC power supply.
8. Route the wiring from the DC/DC power supply to the vehicle's electrical system. **Do not connect to vehicle power at this time.**
9. Strip the wire ends and connect to the input side of the DC/DC power supply.
10. Use looms and wire ties to secure all wiring as shown.
11. Reattach the cover with the screws.

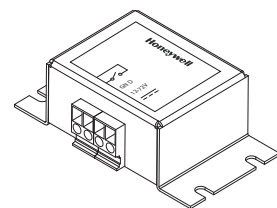

12. If the screen blanking box is used for a Thor VX8 or Thor VX9 installation, attach the stripped green and yellow wire ends to the box. Refer to the applicable following diagram for proper wiring connection.
13. If the screen blanking box is used for a Thor VM1 or Thor VM2 installation, connect a serial cable from the COM port on the Mount Smart Dock to the box. Refer to the applicable following diagram for proper wiring connection.
14. Connect the DC/DC power supply to the vehicle's electrical system as directed below:



<b>Caution:</b> 	<b>For battery powered vehicles:</b> VIN+ is connected to battery positive. VIN- must be connected to battery negative.  GND  must be connected to the vehicle chassis ground.	<b>For internal combustion engine powered vehicles:</b> VIN+ is connected to battery positive. VIN- is connected to battery negative.  GND  is connected to the vehicle chassis ground, which can also be battery negative.

15. While observing the fuse requirements specified above, connect the power cable as close as possible to the actual battery terminals of the vehicle. When available, always connect to unswitched terminals in the vehicle fuse panel, after providing proper fusing.

**ATTENTION: For uninterrupted power, electrical supply connections should not be made at any point after the ignition switch of the vehicle.**

16. If the screen blanking box is used for a VMC installation, connect the box to vehicle motion circuitry and ground. Refer to the applicable following diagram and the label on the screen blanking box for proper wiring connection.
17. Use proper electrical and mechanical fastening means for terminating the cable. Properly sized "crimp" type electrical terminals are an accepted method of termination. Select electrical connectors sized for use with 18AWG (1mm<sup>2</sup>) conductors.
18. Provide mechanical support for the cable by securing it to the vehicle structure at approximately one foot intervals, taking care not to over tighten and pinch conductors or penetrate the outer cable jacket.

**Figure 1a – Thor VM1, Thor VM2 and Thor VM3 Vehicle Mounted Computers**

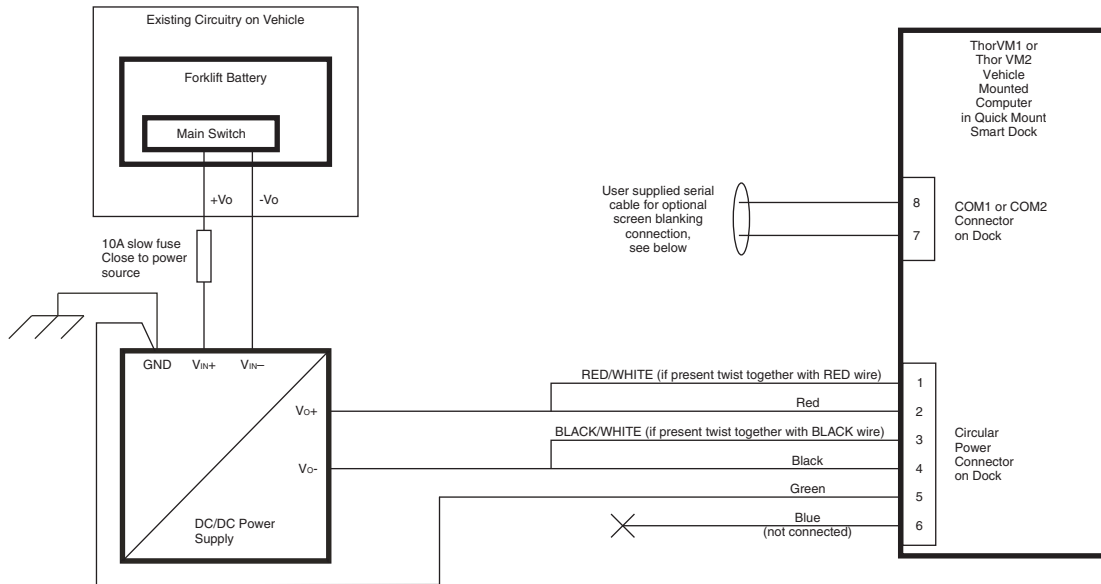

Power cables with a right angle connector have 6 wires. Twist the red and red/white wires together and twist the black and black/white wires together before connecting to the DC/DC power supply. Power cables with a straight connector have 4 wires. Connect the red and black wires to DC/DC power supply.

**Figure 1b – Optional Screen Blanking Connections**

The user must supply the serial cable for the screen blanking connection. Only pins 7 and 8 are used for the screen blanking connection. Screen Blanking is configured via the Screen Control (Thor VM1 and Thor VM2) or the ZoomZone (Thor VM3) option in the Windows Control Panel.

With Screen Blanking Box

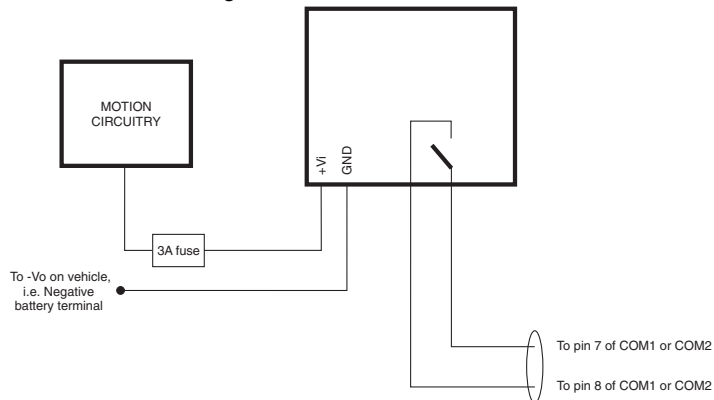

Connect to existing motion circuitry on vehicle – any 12-60 or 12-72 VDC signal triggered by vehicle motion.

Refer to the label on the Screen Blanking Box for allowable voltage input range.

Connect switched terminal on blanking box to Pin 7 of COM port.

With User Supplied Switch / Relay

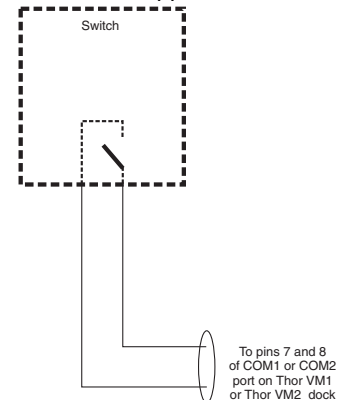

User supplied switch/relay that supplies electrical conductive connection on vehicle motion

**Figure 2a – Thor VX8 and Thor VX9 Vehicle Mounted Computers**

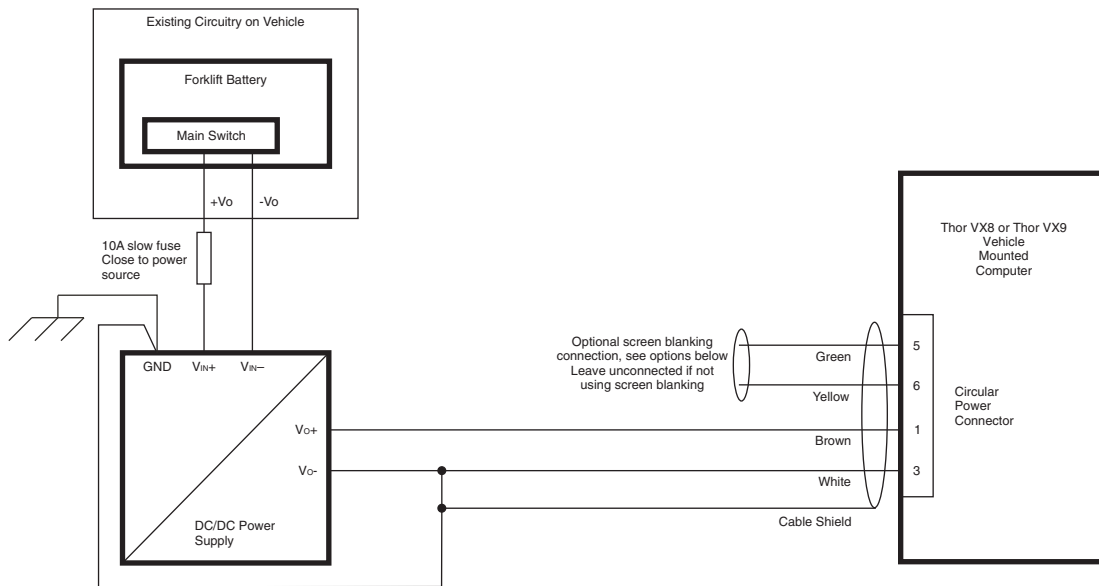

Connect the white wire to both VO- (output side) and GND (input side).  
Connect both the white wire and the cable shield to GND.

**Figure 2b – Optional Screen Blanking Connections**

Screen blanking is configured via the Display Backlight tab of the VMT Manager option in the Windows Control panel.

With Screen Blanking Box

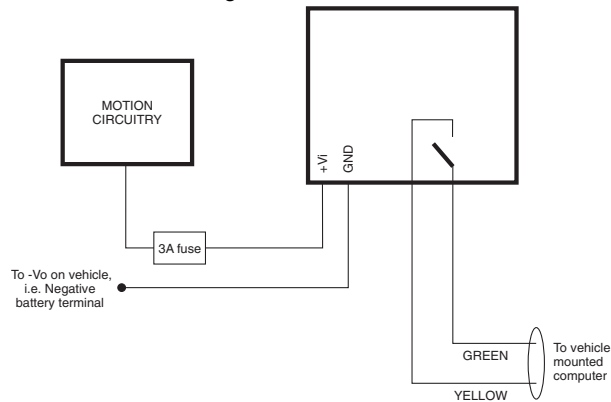

Connect to existing motion circuitry on vehicle – any 12-60 or 12-72 VDC signal triggered by vehicle motion.

Refer to the label on the Screen Blanking Box for allowable voltage input range.

With User Supplied Switch / Relay

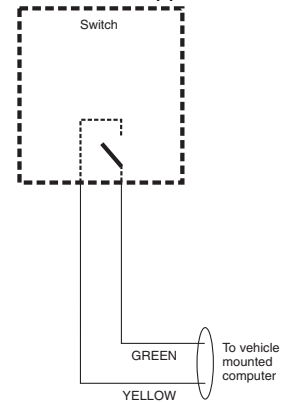

User supplied switch/relay that supplies electrical conductive connection on vehicle motion

**Figure 3 – Marathon Vehicle Dock**

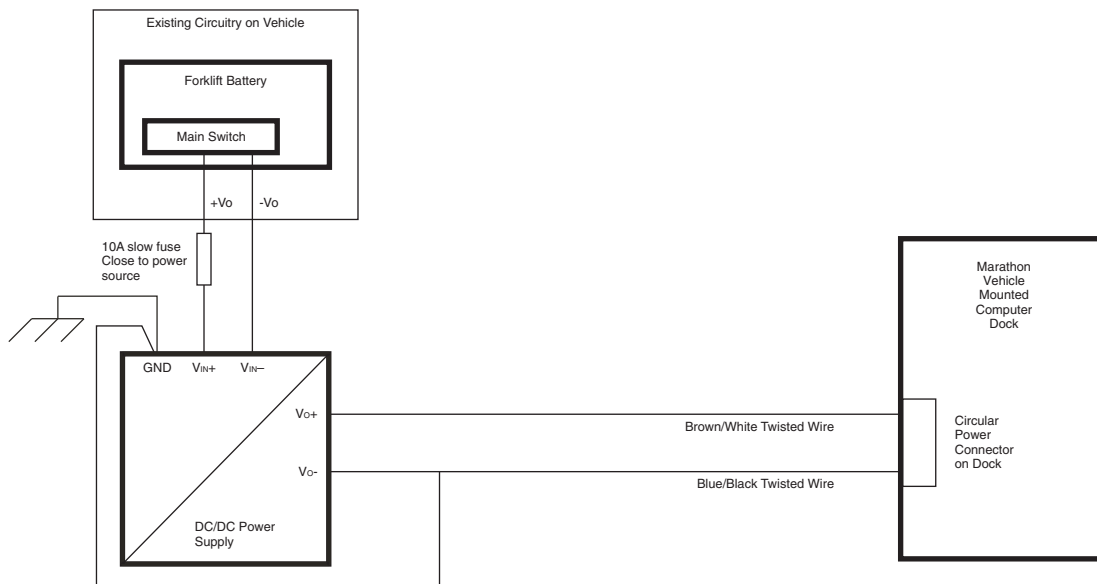

Separate the blue/black twisted wires.

Connect one of the wires to the COM terminal on the output side of the DC/DC power supply and the other to the GND terminal on the input side.

**Figure 4 – Tecton and MX9 Vehicle Cradles**

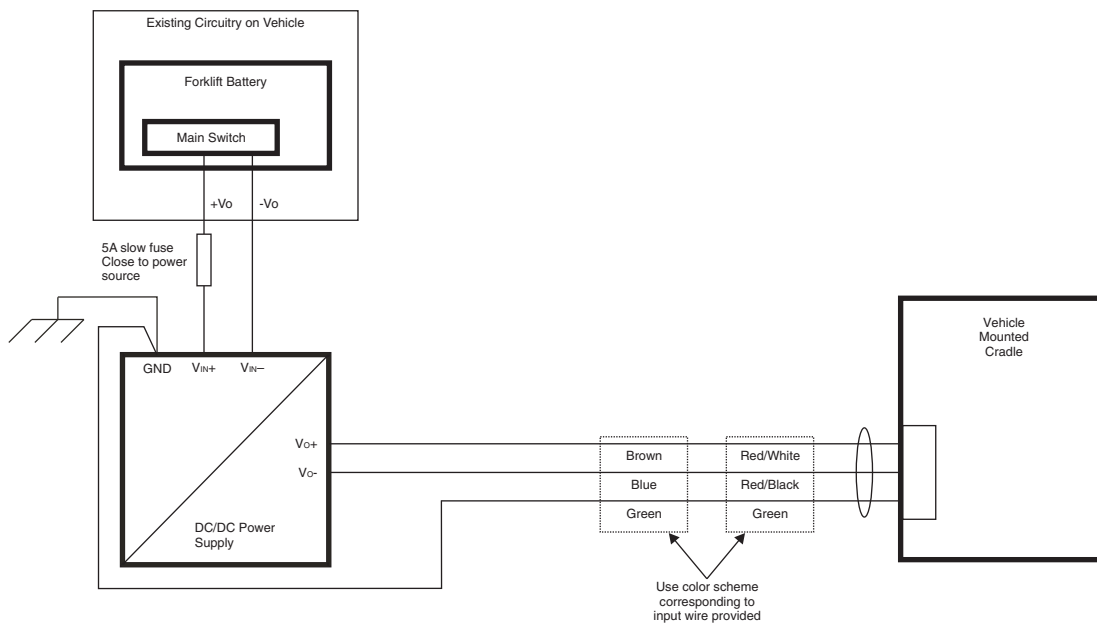

## Figure 5 – Replacing an Earlier Model Power Supply

When this power supply is used to replace an earlier model of power supply, follow the directions below to transfer the wiring from the old power supply to the new power supply. Note that the number and labeling of connectors vary between the power supply models.

### New Power Supply

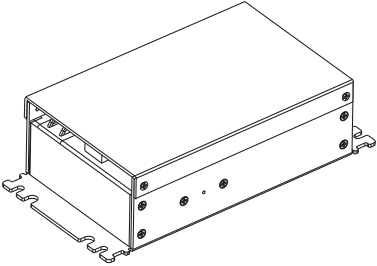
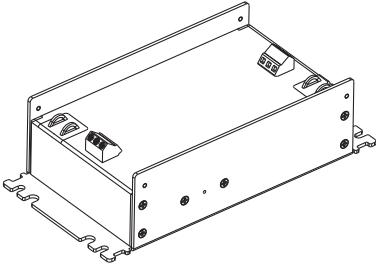
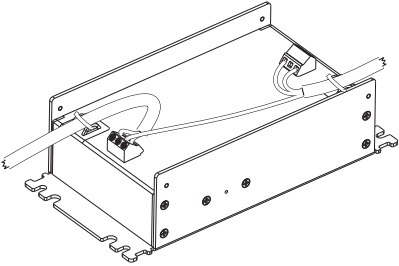
		
<p>Shown With Lid Attached:</p> <ul style="list-style-type: none"> <li>Lid is secured with screws on the side of lid.</li> </ul>	<p>Shown With Lid Removed:</p> <ul style="list-style-type: none"> <li>Input and output connector blocks under lid.</li> <li>One positive (Vin+), negative (Vin-) and ground (<math>\perp</math>) connection in input block.</li> <li>One positive (Vo+) and negative (Vo-) connection in output block.</li> </ul>	<p>Shown with wiring</p>

### Old Power Supply

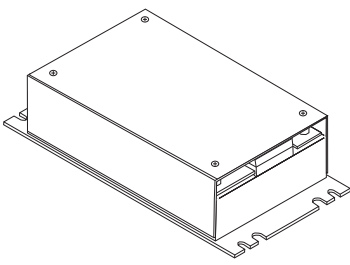
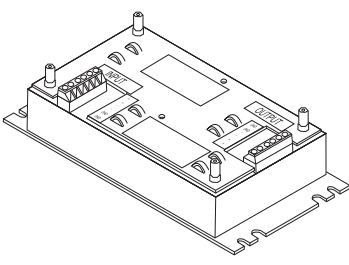
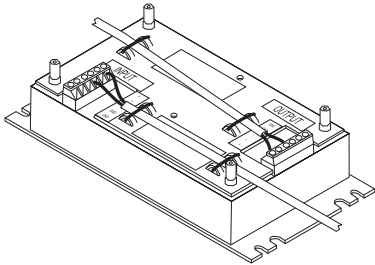
		
<p>Shown With Lid Attached:</p> <ul style="list-style-type: none"> <li>Lid is secured with screws on the top of lid.</li> </ul>	<p>Shown With Lid Removed</p> <ul style="list-style-type: none"> <li>Input and output connector blocks under lid.</li> <li>Two positive (+), two negative (-) and two ground (<math>\oplus</math>) connections per terminal block</li> </ul>	<p>Shown with wiring</p>

Verify the current ground wire is connected as follows. It may be necessary to alter the ground wire connection or add a ground wire. See the earlier equipment specific diagrams for additional grounding details.

<p><b>Caution:</b></p> 	<p><b>For battery powered vehicles:</b> The ground wire must be connected to the vehicle chassis ground.</p>	<p><b>For internal combustion engine powered vehicles:</b> The ground wire is connected to the vehicle chassis ground, which can also be battery negative.</p>
--	--	--

1. Disconnect power supply from vehicle power.
2. Disconnect the wire from the + connection of the output block on the old power supply. Connect to the Vo+ connection on the new power supply.
3. Disconnect the wire from the - connection of the output block on the old power supply. Connect to the Vo- connection on the new power supply.
4. Disconnect the wire from the ground ( $\oplus$ ) connection of the output block on the old power supply. Set this wire aside for now.
5. Disconnect the wire from the + connection of the input block of the old power supply. Connect to the Vin+ connection on the new power supply.

6. Disconnect the wire from the - connection of the input block on the old power supply. Connect to the Vin- connection on the new power supply.
7. Disconnect the wire(s) from the ground ( $\oplus$ ) connection of the input block on the old power supply. Twist together with the ground wire from Step 4 and connect to the ground ( $\text{---}$ ) connection on the new power supply.
8. Reconnect to vehicle power.

## Figure 6 – Connecting Other Devices

This power supply can be used with devices other than the computers mentioned in this document. Be sure the device meets the specifications on Page 1 of this document.

To connect the device, follow these general instructions as well as any instructions that came with the device:

1. Make sure the device is switched off.
2. Remove the lid from the DC/DC power supply.
3. Route the power cable the shortest way possible. When routing wiring, it should be protected from physical damage and from surfaces that might exceed the safe temperature of the wiring. Do not expose the wiring to chemicals or oil that may cause the wiring insulation to deteriorate. Always route the cable so that it does not interfere with safe operation and maintenance of the vehicle.
4. Strip wire ends as necessary.
5. Attach the positive wire(+) from the device to Vo+ connection of the output block on the power supply.
6. Attach the negative wire (-) from the device to Vo- connection of the output block on the power supply.
7. Attach the ground wire from the device to the GND connection of the input block on the power supply.
8. Attach a wire from the Vin+ connection on the power supply to vehicle power positive (+), making sure the connection is within the input voltage range for the selected power supply.
  - In most cases, the power would be connected to an unswitched source.
  - Follow the requirements of the device and install a fuse in the wire. Follow the cautions and warnings on the first page of this document. Consult the device's documentation for fuse specifications.
9. Attach a wire from the Vin- connection on the power supply to vehicle power negative (-).
10. Attach a wire from the GND connection on the input block on the power supply. This same connector was used in Step 4.
  - For battery powered vehicles, the ground wire must be connected to the vehicle chassis ground.
  - For internal combustion engine powered vehicles, the ground wire is connected to the vehicle chassis ground, which can also be battery negative.
11. Use looms and wire ties to secure wiring as shown:
12. Reattach the lid to the power supply with screws.
13. Turn the device on.

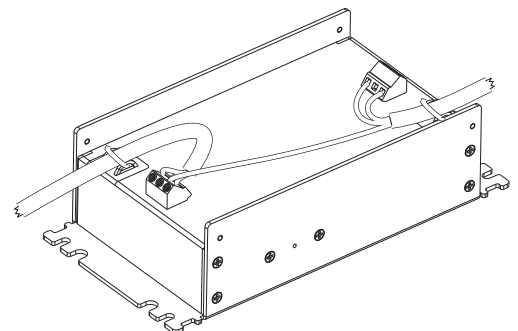
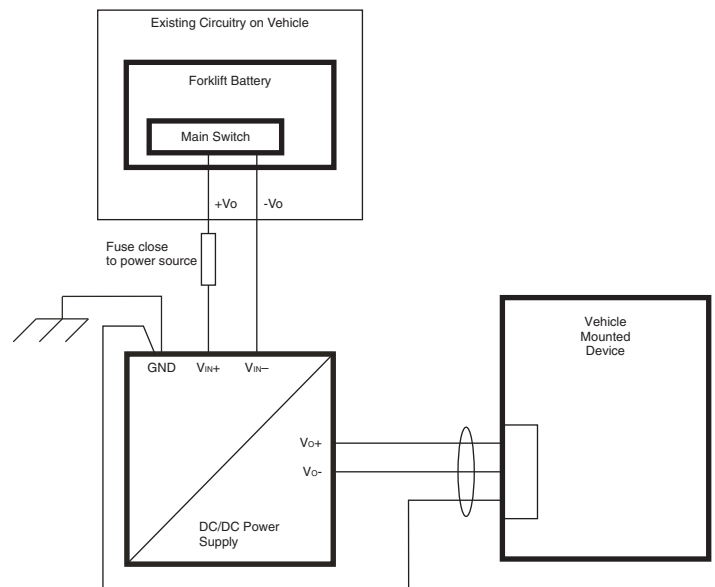

## Figure 7 – Mounting Template

Verify mounting dimensions against actual power supply. Printers and copiers may distort the size of this template - always select **Actual Size** rather than **Fit** or **Shrink Oversize Pages** when printing this PDF file.

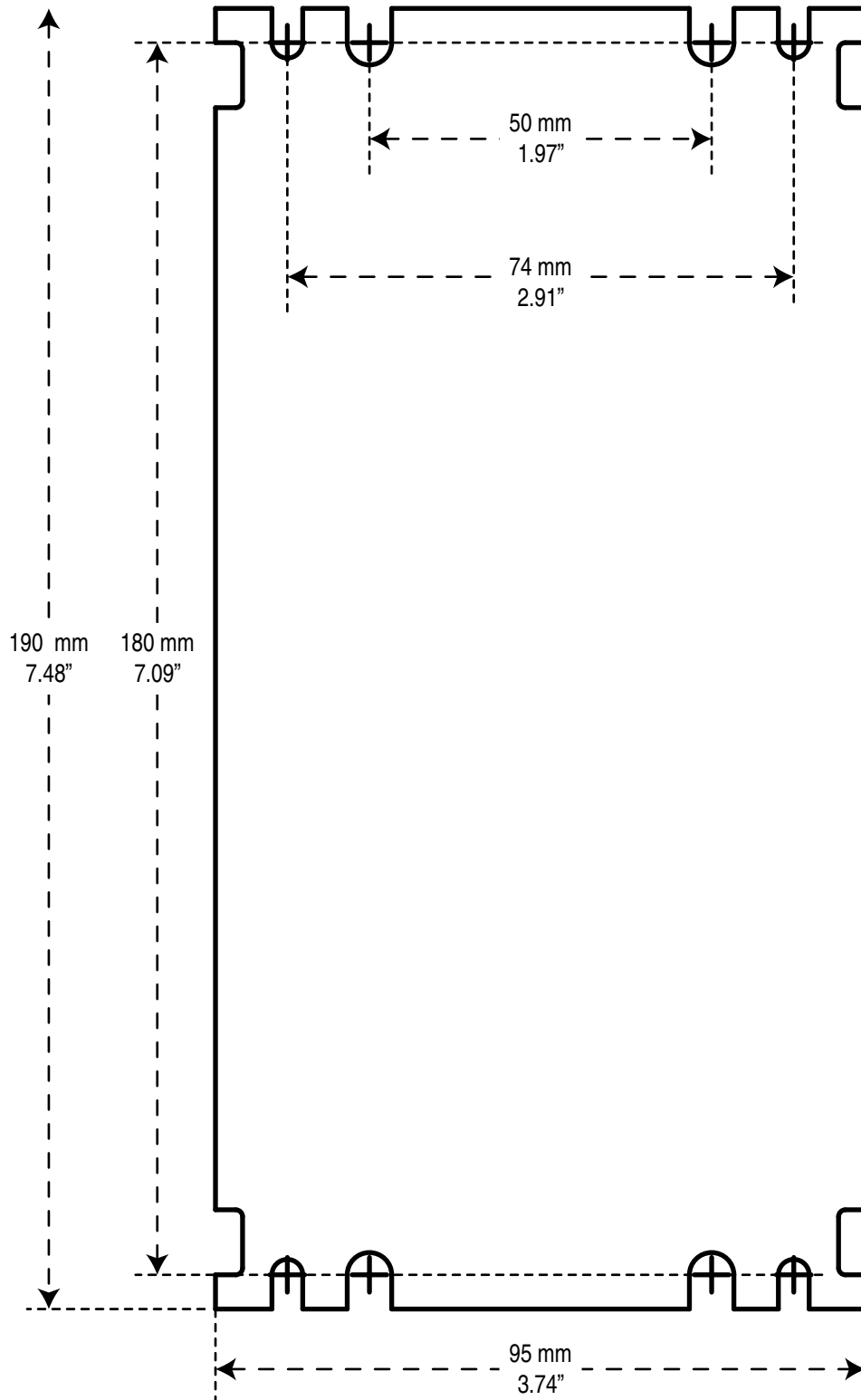



---

## ***Disclaimer***

Honeywell International Inc. (“HII”) reserves the right to make changes in specifications and other information contained in this document without prior notice, and the reader should in all cases consult HII to determine whether any such changes have been made. The information in this publication does not represent a commitment on the part of HII.

HII shall not be liable for technical or editorial errors or omissions contained herein; nor for incidental or consequential damages resulting from the furnishing, performance, or use of this material. HII disclaims all responsibility for the selection and use of software and/or hardware to achieve intended results.

This document contains proprietary information that is protected by copyright. All rights are reserved. No part of this document may be photocopied, reproduced, or translated into another language without the prior written consent of HII.

© 2015 Honeywell International Inc. All rights reserved.

Other product names or marks mentioned in this document may be trademarks or registered trademarks of other companies and are the property of their respective owners.

Web Address: [www.honeywellaidc.com](http://www.honeywellaidc.com)

## ***Patents***

For patent information, please refer to [www.hsmpats.com](http://www.hsmpats.com).

## ***Technical Assistance***

Contact information for technical support, product service, and repair can be found at [www.honeywellaidc.com](http://www.honeywellaidc.com).

## ***Limited Warranty***

Refer to [www.honeywellaidc.com/warranty\\_information](http://www.honeywellaidc.com/warranty_information) for your product's warranty information.

## ***User Documentation***

To download user documentation go to [www.honeywellaidc.com](http://www.honeywellaidc.com).

