

# MINISCAN MSXX04 SERIES INTEGRATION GUIDE

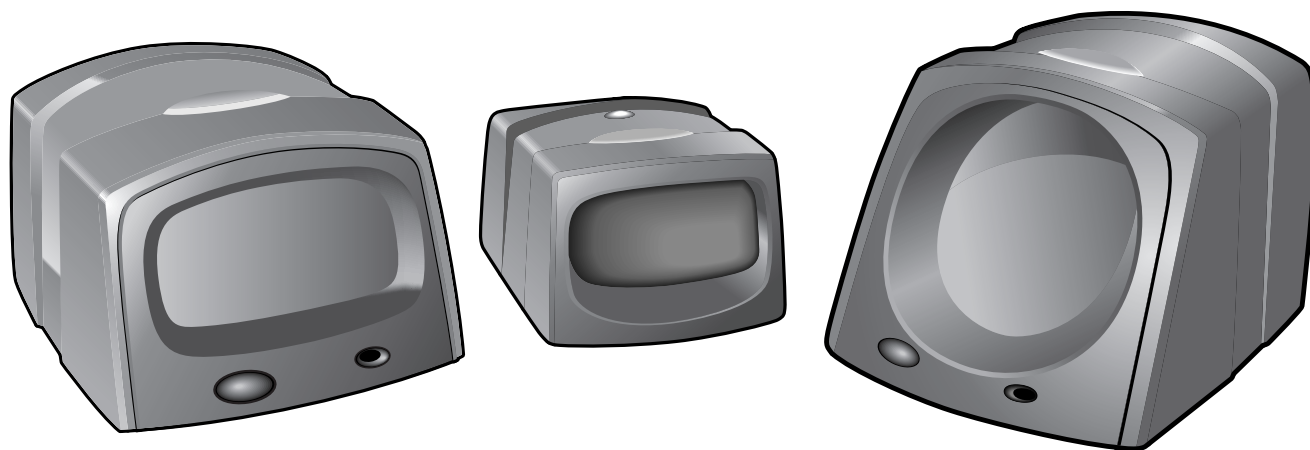



***MiniScan MSXX04 Series  
Integration Guide***

*72E-67134-10*

*Revision A*

*March 2017*

No part of this publication may be reproduced or used in any form, or by any electrical or mechanical means, without permission in writing from Zebra. This includes electronic or mechanical means, such as photocopying, recording, or information storage and retrieval systems. The material in this manual is subject to change without notice.

The software is provided strictly on an “as is” basis. All software, including firmware, furnished to the user is on a licensed basis. Zebra grants to the user a non-transferable and non-exclusive license to use each software or firmware program delivered hereunder (licensed program). Except as noted below, such license may not be assigned, sublicensed, or otherwise transferred by the user without prior written consent of Zebra. No right to copy a licensed program in whole or in part is granted, except as permitted under copyright law. The user shall not modify, merge, or incorporate any form or portion of a licensed program with other program material, create a derivative work from a licensed program, or use a licensed program in a network without written permission from Zebra. The user agrees to maintain Zebra’s copyright notice on the licensed programs delivered hereunder, and to include the same on any authorized copies it makes, in whole or in part. The user agrees not to decompile, disassemble, decode, or reverse engineer any licensed program delivered to the user or any portion thereof.

Zebra reserves the right to make changes to any software or product to improve reliability, function, or design.

Zebra does not assume any product liability arising out of, or in connection with, the application or use of any product, circuit, or application described herein.

No license is granted, either expressly or by implication, estoppel, or otherwise under any Zebra Technologies Corporation, intellectual property rights. An implied license only exists for equipment, circuits, and subsystems contained in Zebra products.

Zebra and the stylized Zebra head are trademarks of ZIH Corp., registered in many jurisdictions worldwide. All other trademarks are the property of their respective owners.

Zebra Technologies Corporation  
Lincolnshire, IL U.S.A.  
<http://www.zebra.com>

---

## Warranty

For the complete Zebra hardware product warranty statement, go to:  
<http://www.zebra.com/warranty>.

---

## Revision History

Changes to the original manual are listed below:

Change	Date	Description
-01 Rev A	2/2004	Initial release.
-02 Rev A	6/2004	Added Embedded Application information.
-03 Rev A	8/2006	Software updates.
-04 Rev A	3/2007	Updated service information and specifications.

<b>Change</b>	<b>Date</b>	<b>Description</b>
-05 Rev A	1/2008	Added new UPC/EAN supplemental options and Bookland ISBN format option, updated troubleshooting.
-06 Rev A	6/2010	Updated scanner mount instructions to include MS954; added instructions for connecting via RS-232, updated power supply part number; updated operating temperature for MS2204 and MS2204VHD; removed patent information; updated power supply information.
-07 Rev A	6/2014	Updated: MS954 specifications and decode zones. Added: MS954 default values table; various parameters for MS954 manufactured on/after July 1, 2014.
-08 Rev A	10/2014	Updated MS954 decode zones.
-09 Rev A	3/2015	Zebra Re-branding
-10 Rev A	3/2017	Added baud rates for the MS954.



# Table of Contents

Warranty .....	ii
Revision History .....	ii

## About This Guide

Introduction .....	xiii
Chapter Descriptions .....	xiii
Notational Conventions .....	xiv
Related Documents .....	xv
Service Information .....	xv

## Chapter 1: Getting Started

Introduction .....	1-1
MS1204FZY, MS2204, MS2204VHD, and MS3204 Features .....	1-2
MS954 Features .....	1-2
Typical Applications .....	1-3
MS1204FZY, MS2204, MS2204VHD, and MS3204 Applications .....	1-3
MS954 Applications .....	1-3
Block Diagrams .....	1-3
MS1204FZY, MS2204, MS2204VHD, and MS3204 Block Diagram .....	1-4
MS954 Block Diagram .....	1-4
Miniscan Block Diagram Descriptions .....	1-5

## Chapter 2: Installation

Introduction .....	2-1
Unpacking .....	2-1
Mounting .....	2-2
MS1204FZY/MS2204/MS2204VHD Mounting Dimensions .....	2-2
MS3204 Mounting Dimensions .....	2-3
MS954 Mounting Dimensions .....	2-3
Mounting the Scanner on the Stand .....	2-4
Mounting the Scanner on the Mounting Bracket .....	2-5

Connecting the MiniScan .....	2-7
Connecting the MSXX04 via RS-232 .....	2-8
Location and Positioning .....	2-9
Using the MiniScan as an Embedded Scanner .....	2-9
Conveyor Applications .....	2-12
Embedded Applications Requiring a Window .....	2-13
Accessories .....	2-17
Simple Serial Interface Software Developer's Kit (SSISDK) .....	2-18

### Chapter 3: Scanning

Introduction .....	3-1
MiniScan Scan Patterns .....	3-1
MS1204FZY / MS954 Scan Pattern .....	3-1
MS2204 and MS2204VHD Scan Patterns .....	3-2
MS3204 Scan Patterns .....	3-3
Scan Angle Selection .....	3-4
Selecting Scan Angle via SSI .....	3-4
Selecting Scan Angle via Parameter Bar Code .....	3-4
Operation in Blink Mode .....	3-4
Scanning Tips .....	3-5
Scan the Entire Symbol .....	3-5
Position at an Angle .....	3-5
Trigger Options .....	3-5
Continuous .....	3-5
Level Trigger .....	3-6
Pulse Trigger .....	3-6
Blink .....	3-6
Host Trigger .....	3-6
Beeper and LED Definitions .....	3-7

### Chapter 4: MS1204FZY Specifications

Introduction .....	4-1
MS1204FZY Electrical Interface .....	4-1
MS1204FZY Mechanical Drawings .....	4-3
MS1204FZY Technical Specifications .....	4-5
MS1204FZY Decode Zone .....	4-7
Usable Scan Length .....	4-8

### Chapter 5: MS2204 Specifications

Introduction .....	5-1
MS2204 Electrical Interface .....	5-1
MS2204 Mechanical Drawings .....	5-3
MS2204 Technical Specifications .....	5-5
MS2204 Decode Zones .....	5-8
MS2204 1D Decode Zone .....	5-8
MS2204 1D Decode Distances .....	5-9
MS2204 2D Decode Zone .....	5-10



MS2204 2D Decode Distances .....	5-11
Usable Scan Length .....	5-11
<b>Chapter 6: MS2204VHD Specifications</b>	
Introduction .....	6-1
MS2204VHD Electrical Interface .....	6-1
MS2204VHD Mechanical Drawings .....	6-3
MS2204VHD Technical Specifications .....	6-5
MS2204VHD Decode Zones .....	6-8
MS2204VHD 1D Decode Zone .....	6-8
MS2204VHD 1D Decode Distances .....	6-9
MS2204VHD 2D Decode Zone .....	6-10
MS2204VHD 2D Decode Distances .....	6-11
Usable Scan Length .....	6-11
<b>Chapter 7: MS3204 Specifications</b>	
Introduction .....	7-1
MS3204 Electrical Interface .....	7-2
MS3204 Mechanical Drawings .....	7-3
MS3204 Technical Specifications .....	7-5
MS3204 Decode Zones .....	7-8
Omnidirectional Decode Distances .....	7-8
2D Slab/Raster Decode Distances (MS3204-I000 Only) .....	7-10
Usable Scan Length .....	7-11
<b>Chapter 8: MS954 Specifications</b>	
Introduction .....	8-1
MS954 Electrical Interface .....	8-2
MS954 Mechanical Drawings .....	8-3
MS954 Technical Specifications .....	8-5
MS954 Decode Zone .....	8-7
Usable Scan Length .....	8-10
<b>Chapter 9: Maintenance and Troubleshooting</b>	
Introduction .....	9-1
Maintenance .....	9-1
Troubleshooting .....	9-2
<b>Chapter 10: Parameter Menus</b>	
Introduction .....	10-1
Operational Parameters .....	10-2
Default Table .....	10-2
Default Table for MS954 .....	10-8
Set Default Parameter .....	10-14
Set Defaults - MS1204, MS1204VHD, MS3204 .....	10-14

Set Defaults - MS954 .....	10-15
Scanning Options .....	10-16
Beeper Volume .....	10-16
Beeper Tone .....	10-17
Beeper Frequency Adjustment .....	10-17
Laser On Time .....	10-18
Scan Angle .....	10-18
Power Mode .....	10-19
Trigger Modes .....	10-20
Scanning Mode .....	10-21
Enhanced Aim Timeouts .....	10-22
Aiming Mode .....	10-23
Programmable Raster Height And Raster Expansion Speed .....	10-24
Timeout Between Decodes .....	10-25
Beep After Good Decode .....	10-26
Transmit "No Read" Message .....	10-27
Parameter Scanning .....	10-28
Parameter Pass Through .....	10-29
Linear Code Type Security Level .....	10-30
Bi-directional Redundancy .....	10-32
Adaptive Scanning .....	10-33
Interference Suppression Mode .....	10-34
Interference Suppression Scan Angle .....	10-35
UPC/EAN .....	10-36
Enable/Disable UPC-A .....	10-36
Enable/Disable UPC-E .....	10-36
Enable/Disable UPC-E1 .....	10-37
Enable/Disable EAN-8 .....	10-38
Enable/Disable EAN-13 .....	10-38
Enable/Disable Bookland EAN .....	10-39
UPC/EAN Coupon Code .....	10-40
Decode UPC/EAN Supplementals .....	10-41
User-Programmable Supplementals .....	10-45
Decode UPC/EAN Supplemental Redundancy .....	10-45
UPC/EAN/JAN Supplemental AIM ID Format .....	10-46
Transmit UPC-A Check Digit .....	10-47
Transmit UPC-E Check Digit .....	10-47
Transmit UPC-E1 Check Digit .....	10-48
UPC-A Preamble .....	10-49
UPC-E Preamble .....	10-50
UPC-E1 Preamble .....	10-51
Convert UPC-E to UPC-A .....	10-52
Convert UPC-E1 to UPC-A .....	10-53
EAN Zero Extend .....	10-53
Bookland ISBN Format .....	10-54
UPC/EAN Security Level .....	10-55
Linear UPC/EAN Decode .....	10-56
UPC Half Block Stitching .....	10-56
ISSN EAN .....	10-57
Coupon Report .....	10-58

Code 128 .....	10-59
Enable/Disable Code 128 .....	10-59
Enable/Disable GS1-128 (formerly UCC/EAN-128) .....	10-59
Enable/Disable ISBT 128 .....	10-60
ISBT Concatenation .....	10-61
Lengths for Code 128 .....	10-61
Code 128 Decode Performance .....	10-62
Code 128 Decode Performance Level .....	10-63
Code 39 .....	10-64
Enable/Disable Code 39 .....	10-64
Enable/Disable Trioptic Code 39 .....	10-64
Convert Code 39 to Code 32 .....	10-65
Code 32 Prefix .....	10-66
Set Lengths for Code 39 .....	10-67
Code 39 Check Digit Verification .....	10-68
Transmit Code 39 Check Digit .....	10-68
Enable/Disable Code 39 Full ASCII .....	10-69
Code 39 Decode Performance .....	10-70
Code 39 Decode Performance Level .....	10-71
Code 93 .....	10-72
Enable/Disable Code 93 .....	10-72
Set Lengths for Code 93 .....	10-73
Code 11 .....	10-74
Enable/Disable Code 11 .....	10-74
Set Lengths for Code 11 .....	10-75
Code 11 Check Digit Verification .....	10-76
Transmit Code 11 Check Digit .....	10-77
Interleaved 2 of 5 .....	10-78
Enable/Disable Interleaved 2 of 5 .....	10-78
Set Lengths for Interleaved 2 of 5 .....	10-79
I 2 of 5 Check Digit Verification .....	10-80
Transmit I 2 of 5 Check Digit .....	10-81
Convert I 2 of 5 to EAN-13 .....	10-81
Discrete 2 of 5 .....	10-82
Enable/Disable Discrete 2 of 5 .....	10-82
Set Lengths for Discrete 2 of 5 .....	10-83
Chinese 2 of 5 .....	10-84
Enable/Disable Chinese 2 of 5 .....	10-84
Korean 3 of 5 .....	10-85
Enable/Disable Korean 3 of 5 .....	10-85
Chinese 2 of 5 .....	10-86
Enable/Disable Chinese 2 of 5 .....	10-86
Matrix 2 of 5 .....	10-86
Enable/Disable Matrix 2 of 5 .....	10-86
Set Lengths for Matrix 2 of 5. ....	10-87
Matrix 2 of 5 Check Digit .....	10-89
.....	10-89
Transmit Matrix 2 of 5 Check Digit .....	10-89
Codabar .....	10-90
Enable/Disable Codabar .....	10-90

Set Lengths for Codabar .....	10-91
CLSI Editing .....	10-92
NOTIS Editing .....	10-92
Codabar Upper or Lower Case Start/Stop Characters Detection .....	10-93
MSI Plessey .....	10-94
Enable/Disable MSI Plessey .....	10-94
Set Lengths for MSI Plessey .....	10-95
MSI Plessey Check Digits .....	10-96
Transmit MSI Plessey Check Digit .....	10-96
MSI Plessey Check Digit Algorithm .....	10-97
PDF417/MicroPDF417 .....	10-98
Enable/Disable PDF417 .....	10-98
Enable/Disable MicroPDF417 .....	10-98
MicroPDF Performance .....	10-99
Code 128 Emulation .....	10-100
GS1 DataBar .....	10-101
GS1 DataBar-14 .....	10-101
GS1 DataBar Limited .....	10-101
GS1 DataBar Expanded .....	10-102
GS1 DataBar Limited Security Level .....	10-103
Convert GS1 DataBar to UPC/EAN .....	10-104
Composite .....	10-105
Composite CC-C .....	10-105
Composite CC-A/B .....	10-106
Composite TLC-39 .....	10-106
UPC Composite Mode .....	10-107
Data Options .....	10-108
Transmit Code ID Character .....	10-108
Prefix/Suffix Values .....	10-110
Scan Data Transmission Format .....	10-111
Simple Serial Interface (SSI) Options .....	10-113
Baud Rate .....	10-113
Baud Rate - For MS954 Devices Manufactured After July 1, 2014 .....	10-115
Parity .....	10-117
Check Parity .....	10-118
Software Handshaking .....	10-119
Host RTS Line State .....	10-120
Decode Data Packet Format .....	10-121
Stop Bit Select .....	10-121
Intercharacter Delay .....	10-122
Host Serial Response Time-out .....	10-122
Host Character Time-out .....	10-122
Event Reporting .....	10-123
Decode Event .....	10-123
Boot Up Event .....	10-124
Parameter Event .....	10-124
Macro PDF Features .....	10-125
Transmit Symbols in Codeword Format .....	10-125
Transmit Unknown Codewords .....	10-126
Escape Characters .....	10-127

Delete Character Set ECIs .....	10-128
ECI Decoder .....	10-129
Transmit Macro PDF User-Selected Fields .....	10-130
Transmit File Name .....	10-130
Transmit Block Count .....	10-131
Transmit Time Stamp .....	10-131
Transmit Sender .....	10-132
Transmit Addressee .....	10-132
Transmit Checksum .....	10-133
Transmit File Size .....	10-133
Transmit Macro PDF Control Header .....	10-134
Last Blocker Marker .....	10-134
Numeric Bar Codes .....	10-135
Cancel .....	10-137

## Chapter 11: Simple Serial Interface (SSI)

Introduction .....	11-1
Revision String .....	11-1
SSI Commands Not Supported .....	11-2

## Chapter 12: Mounting Templates

Introduction .....	12-1
MS1204FZY/MS2204/MS2204VHD Mounting Template .....	12-1
MS3204 Mounting Template .....	12-2
MS954 Mounting Template .....	12-2

## Appendix A: ASCII Character Sets

RS-232 ASCII Character Set .....	A-1
USB ASCII Character Set .....	A-6

## Glossary

## Index

Tell Us What You Think...



# About This Guide

---

## Introduction

The *MiniScan MSXX04 Series Integration Guide* provides general instructions for mounting, setting up, and programming the following MiniScan models:

- MS954
- MS1204FZY
- MS2204
- MS2204VHD
- MS3204.



**NOTE** Zebra recommends that an opto-mechanical engineer perform an opto-mechanical analysis prior to integration.

---

## Chapter Descriptions

This guide includes the following topics:

- [Chapter 1, Getting Started](#) provides an overview of the MiniScan scanners and features, and a block diagram of the scanner.
- [Chapter 2, Installation](#) describes how to mount and install the MiniScan scanner.
- [Chapter 3, Scanning](#) provides information on scan patterns, scanning, triggering options, and beeper and LED definitions.
- [Chapter 4, MS1204FZY Specifications](#) provides the technical and scanning specifications for the MS1204FZY scanner.
- [Chapter 5, MS2204 Specifications](#) provides the technical and scanning specifications for the MS2204 scanner.
- [Chapter 6, MS2204VHD Specifications](#) provides the technical and scanning specifications for the MS2204VHD scanner.

- *Chapter 7, MS3204 Specifications* provides the technical and scanning specifications for the MS3204 scanner.
- *Chapter 8, MS954 Specifications* provides the technical and scanning specifications for the MS954 scanner.
- *Chapter 9, Maintenance and Troubleshooting* provides information on maintaining and troubleshooting the MiniScan scanners.
- *Chapter 10, Parameter Menus* describes the programmable parameters, and provides bar codes for programming and hexadecimal equivalents for host download programming.
- *Chapter 11, Simple Serial Interface (SSI)* describes scanner-specific updates to the *Simple Serial Interface (SSI) Programmer's Guide*.
- *Chapter 12, Mounting Templates* provides mounting templates for the MiniScan scanners.
- *Appendix A, ASCII Character Sets* provides prefix and suffix values to assign for ASCII character data transmission.

---

## Notational Conventions

The following conventions are used in this document:

- *Italics* are used to highlight chapters and sections in this and related documents.
- bullets (•) indicate:
  - Action items
  - Lists of alternatives
  - Lists of required steps that are not necessarily sequential
- Sequential lists (e.g., those that describe step-by-step procedures) appear as numbered lists.



**NOTE** This symbol indicates something of special interest or importance to the reader. Failure to read the note will not result in physical harm to the reader, equipment or data.



**CAUTION** This symbol indicates that if this information is ignored, the possibility of data or material damage may occur.



**WARNING!** This symbol indicates that if this information is ignored the possibility that serious personal injury may occur.



---

## Related Documents

The following documents provide more information for the MiniScan Series scanners.

- *MiniScan Family of Scanners Quick Reference Guide*, p/n 72-58809-xx
- *Simple Serial Interface (SSI) Programmer's Guide*, p/n 72-40451-xx
- *Simple Serial Interface (SSI) Developer's Guide*, p/n 72-50705-xx

For the latest version of this guide and all guides, go to: <http://www.zebra.com/support>.

---

## Service Information

If you have a problem using the equipment, contact your facility's technical or systems support. If there is a problem with the equipment, they will contact the Zebra Global Customer Support Center at: <http://www.zebra.com/support>.

When contacting Zebra Support, please have the following information available:

- Serial number of the unit
- Model number or product name
- Software type and version number.

Zebra responds to calls by E-mail, telephone or fax within the time limits set forth in support agreements.

If your problem cannot be solved by Zebra Support, you may need to return your equipment for servicing and will be given specific directions. Zebra is not responsible for any damages incurred during shipment if the approved shipping container is not used. Shipping the units improperly can possibly void the warranty.

If you purchased your business product from a Zebra business partner, contact that business partner for support.



# Chapter 1 Getting Started



**CAUTION** Use of controls, adjustments or procedures other than those specified here can result in hazardous laser light exposure.

---

## Introduction

The MiniScan family of fixed-mount scanners is specifically designed for stand-alone applications, and OEM applications such as kiosks.

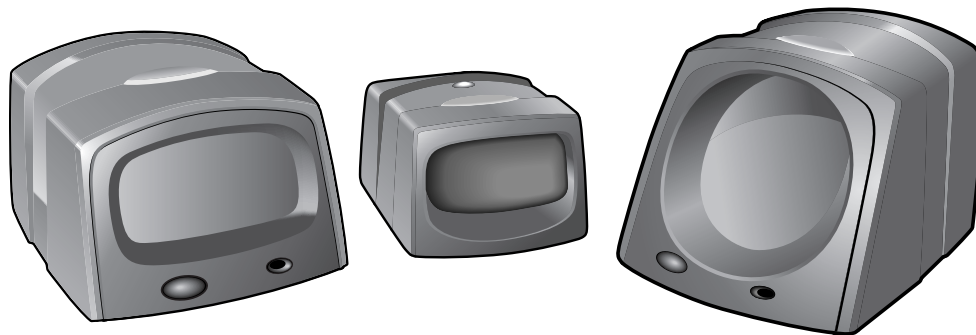

**Figure 1-1** *MiniScan Family of Scanners*

MSXX04 Series scanners provide easy and flexible integration of bar code scanning into a host device, and include the following models:

- The **MS1204FZY** offers fuzzy logic for premium scanning performance on all types of 1D bar codes including poorly printed and low contrast symbols. The MS1204FZY features a compact design for superior performance and durability in a form factor that easily integrates into OEM devices for embedded applications such as medical instruments, diagnostic equipment, vending machines, and gaming. As a fixed-mount scanner, the MS1204FZY is ideal for applications requiring unattended scanning such as manufacturing, warehouse and shipping, conveyor belts, library and document tracking systems.

- The **MS2204** and **MS2204VHD** offer a "smart" raster pattern optimized for 2D applications and poorly printed 1D bar codes. The high scan rate ensures fast and reliable data on all 1D symbols, and 2D codes such as PDF417, MicroPDF, GS1 DataBar and composite codes. These scanners are perfect for automated data entry applications that require high-speed scanning, performance, and small size, such as conveyor belts, manufacturing and warehouse, gas pumps, and security/ID verification.
- The **MS3204** features a high-speed omnidirectional scan pattern that makes it easy and intuitive for consumers to scan bar codes at the point of activity. The omnidirectional scan pattern reads bar codes quickly and accurately, minimizing the need for precise positioning of linear 1D bar codes. The MS3204 provides an easy and cost-effective way to enhance existing OEM devices with high-performance 1D and 2D scanning, making it the ideal solution for applications that require fast, accurate scanning such as kiosks, ATMs, listening stations, lottery machines, and vending machines.
- **MS954** scanner is extremely compact, provides easy and flexible integration of bar code scanning into a host device, and offers high-performance scanning on 1D bar codes. The MS954 is ideal for medical instruments and kiosks.

### **MS1204FZY, MS2204, MS2204VHD, and MS3204 Features**

- Stand-alone or OEM applications
- Quick and easy integration for OEM devices
- Excellent scanning performance on all types of bar codes (MS1204FZY supports 1D bar codes only)
- Rugged IP54 sealed housing with integrated beeper
- RS-232
- Easy programming and configuration
- Flexible mounting options
- LEDs and an integrated beeper indicating scanner power status and successful decodes.

### **MS954 Features**

- Stand-alone or OEM applications
- Quick and easy integration for OEM devices
- Excellent scanning performance on 1D bar codes
- RS-232
- Easy programming and configuration
- Flexible mounting options
- LEDs indicating scanner power status and successful decodes.

---

## Typical Applications

### **MS1204FZY, MS2204, MS2204VHD, and MS3204 Applications**

#### Fixed Mount Standalone Applications

- Manufacturing / warehouse
- Conveyer belts
- Security / ID verification
- POS.

#### OEM Applications

- Kiosks / ATMs
- Music listening stations
- Security / ID verification
- Lottery terminals / gaming.

### **MS954 Applications**

#### Fixed Mount Standalone Applications

- Clinical diagnostics
- Medical instruments
- Assembly lines.

#### OEM Applications

- Kiosks / ATMs
- Music listening stations
- Medical instruments
- Clinical diagnostics
- Lottery terminals / gaming.

---

## Block Diagrams

The MiniScan block diagrams illustrate the functional relationship of MiniScan components. A detailed description of each component in the block diagrams follows.

### MS1204FZY, MS2204, MS2204VHD, and MS3204 Block Diagram

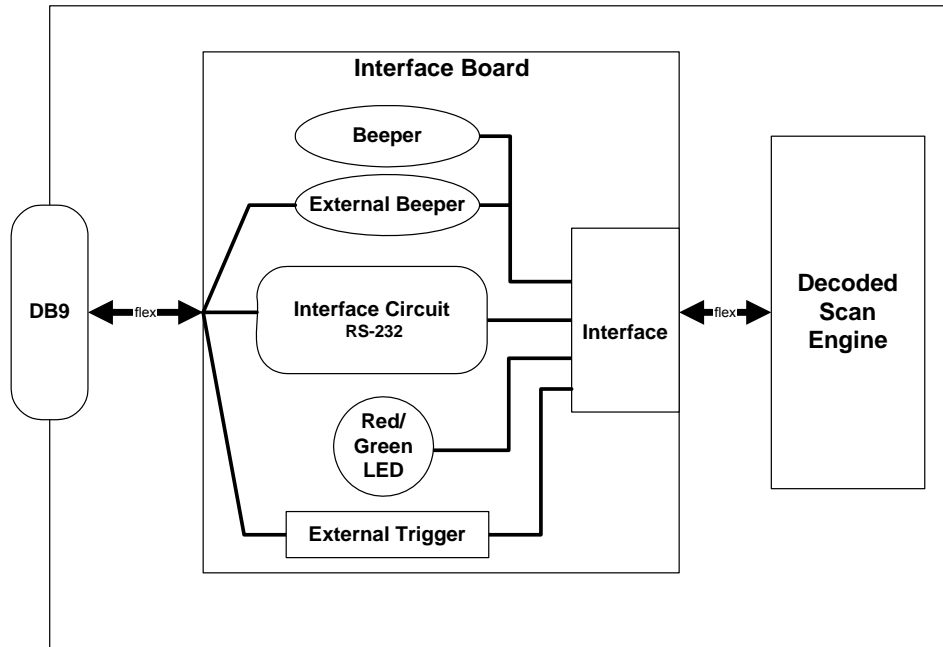

Figure 1-2 MS1204FZY, MS2204, MS2204VHD, and MS3204 Block Diagram

### MS954 Block Diagram

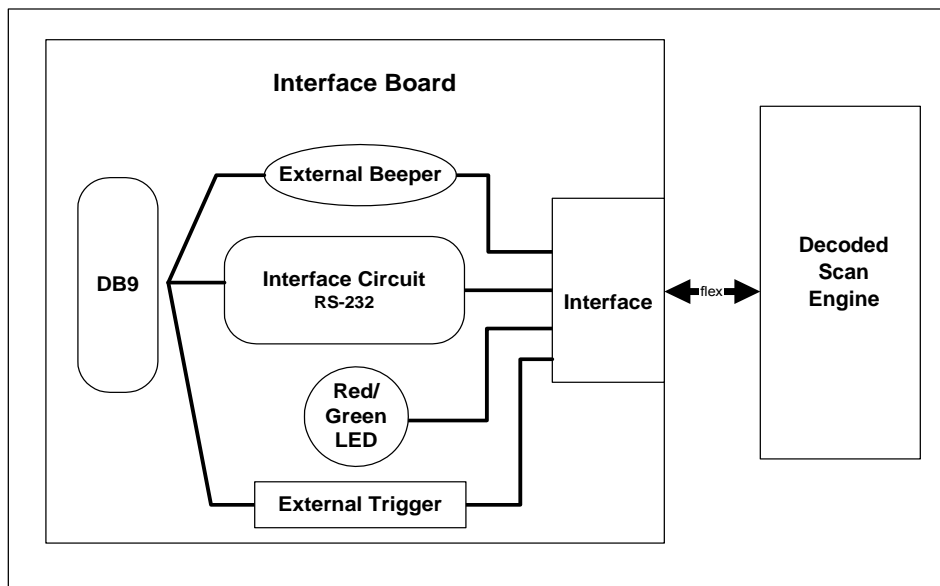

Figure 1-3 MS954 Block Diagram

## Miniscan Block Diagram Descriptions

**Decoded Scan Engine** - The scan engine emits a beam of laser light that reflects off the bar code to decode. Black bars absorb light, white spaces reflect light. The scan engine collects the reflected light and processes the signal through several analog filters. The filtered signal is digitized into a Digitized Barcode Pattern (DBP). The decoder micro-controller analyzes timing information to decode and transmit the bar code data. Data transmission occurs using Zebra's proprietary SSI Interface.

**Interface Board** - The interface board adapts the scan engine's interface into usable signals and data for the intended host. It also contains a beeper (MS1204FZY/2204/2204VHD/3204 models only) and red/green LED for audio/visual feedback, and provides for an external trigger and external beeper.

The MiniScan interface board converts TTL level SSI signals to proper RS-232 levels for connecting to any RS-232 compliant host.

**DB9** - The DB9 connector provides an outlet for the various interface signals used between a MiniScan scanner and the host. It also maintains pin compatibility with the previous generation LS1220 MiniScan host cables.





# Chapter 2 Installation

---

## Introduction

This chapter provides information on unpacking, mounting, and installing the MiniScan scanner.

---

## Unpacking

Remove the MiniScan from its packing and inspect for damage. If the scanner is damaged, call Zebra Support at the telephone number listed on [page xv](#).

KEEP THE PACKING. It is the approved shipping container and should be used if the equipment needs to be returned for servicing.

## Mounting

There are three mounting holes (threaded inserts) on the bottom of the MS1204FZY/2204/2204VHD/3204 chassis; two mounting holes on the MS954.

The following figures provide mounting dimensions for the MiniScan scanner housings. For a mounting template, see [Chapter 12, Mounting Templates](#).

✓ **NOTE** Use only non-magnetic M3x.5 screws with a maximum length of 3.6M to mount the MiniScan scanner chassis.

### MS1204FZY/MS2204/MS2204VHD Mounting Dimensions

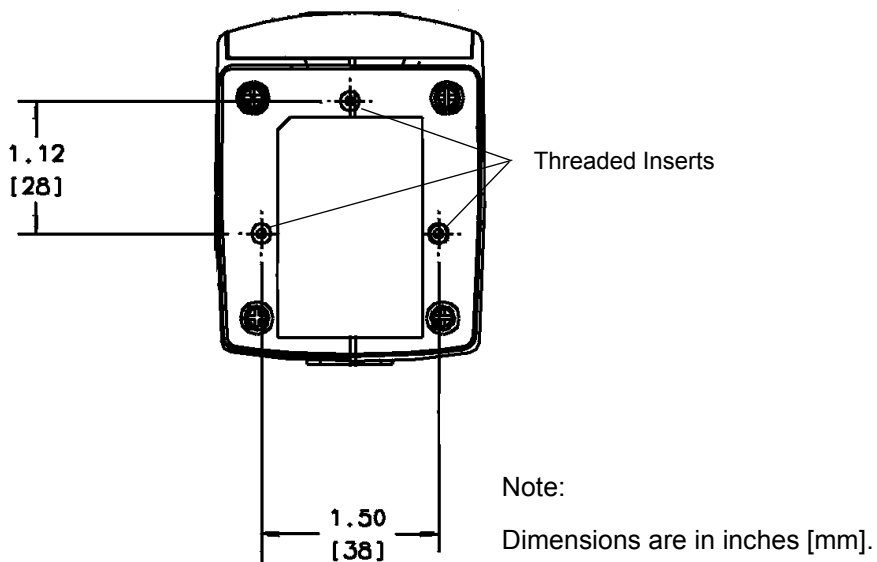

Figure 2-1 MS1204FZY/MS2204/MS2204VHD Mounting Dimensions

### MS3204 Mounting Dimensions

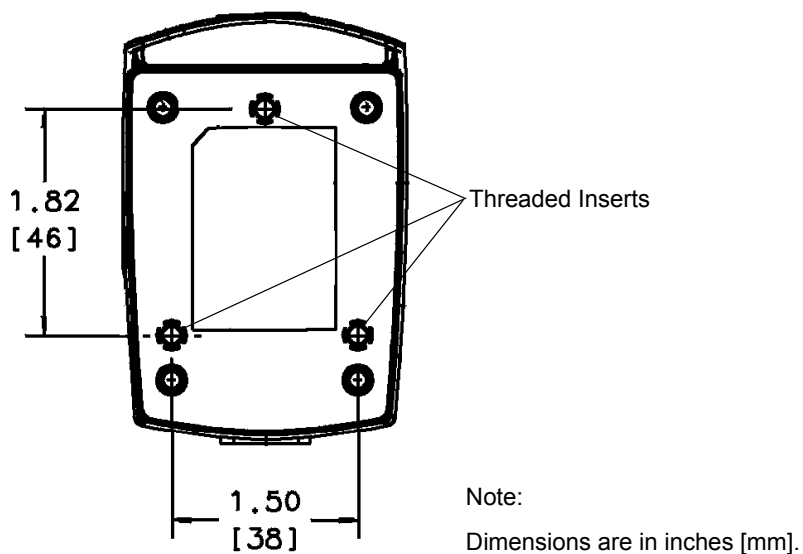

Figure 2-2 MS3204 Mounting Dimensions

### MS954 Mounting Dimensions

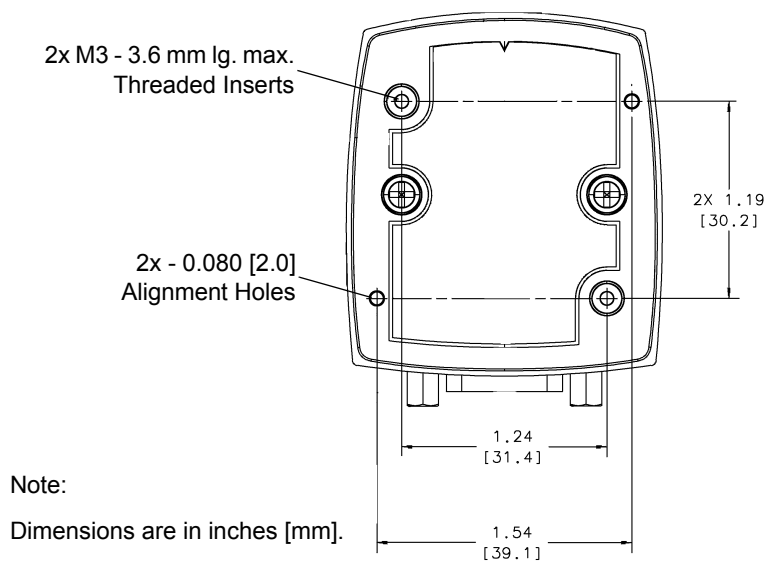

Figure 2-3 MS954 Mounting Dimensions

## Mounting the Scanner on the Stand

To mount the scanner on the optional stand:

1. To mount the MS954 to the scanner mount plate, align the scanner so its window faces the short edge of the plate, and its two threaded inserts align with the stand's two mounting holes that are closest to the edge of the plastic. Note that this model requires only two screws for mounting.

To mount all other MiniScan models, place the bottom of the scanner on the stand's scanner mount, aligning the scanner's center threaded insert (beneath the scan window) with the center mounting hole on the front of the stand. The two rear threaded inserts on the bottom of the scanner align with the proper mounting holes on the stand.

2. Secure the scanner to the stand using the screws provided with the stand (two for the MS954, three for all other models).

## Assembling the Stand

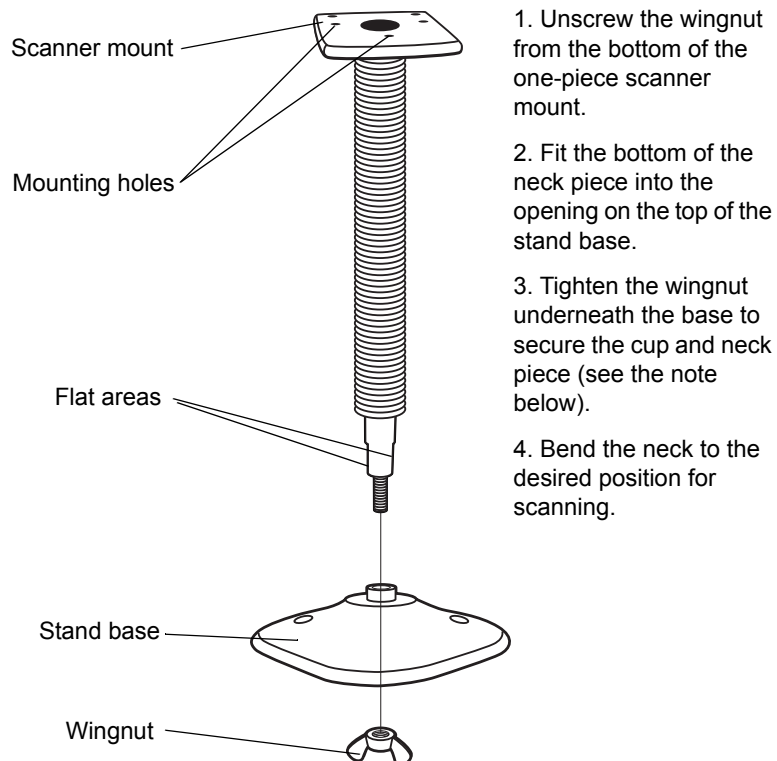

**Figure 2-4** Assembling the Stand



**NOTE** Before tightening the wingnut under the base, ensure that the flat areas on the flexible neck fit securely in the grooves in the base.

## Mounting the Stand (optional)

You can attach the base of the scanner's stand to a flat surface using two screws or double-sided tape (not provided).

### Screw Mount

1. Position the assembled base on a flat surface.
2. Screw one #10 wood screw into each screw-mount hole to secure the base of the stand.

### Tape Mount

1. Peel the paper liner off one side of each piece of tape and place the sticky surface over each of the three rectangular tape areas.
2. Peel the paper liner off the exposed sides of each piece of tape and press the stand on a flat surface until it is secure.

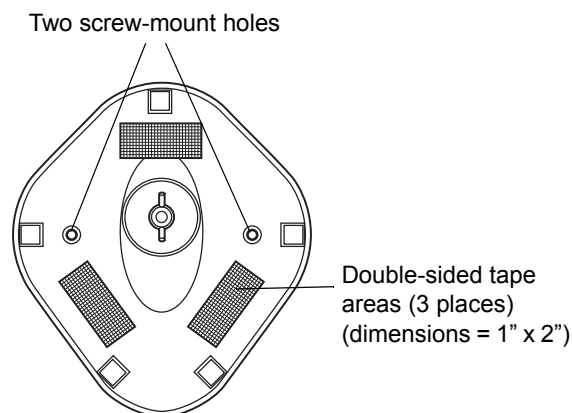

Figure 2-5 Mounting the Stand

## Mounting the Scanner on the Mounting Bracket

✓ **NOTE** The optional mounting bracket is for the MS1204FZY, MS2204, MS2204VHD, and MS3204 only.

The optional mounting bracket kit consists of a scanner bracket, a mounting bracket, and the hardware required to mount the scanner. The bracket kit accommodates adjustable angles for optimal positioning of the scanner.

To mount the MiniScan scanner on the bracket, first secure the scanner to the scanner bracket, then attach the mounting bracket to the wall (see [Figure 2-6 on page 2-6](#)):

1. Tilt the scanner bracket forward to access the center scanner mounting hole on the bracket.
2. Place the bottom of the scanner on the scanner bracket, aligning the scanner's center threaded insert (beneath the scan window) with the center mounting hole on the scanner bracket.
3. Insert one of the screws provided through the mounting hole and into the scanner's center threaded insert.

For the MS1204FZY, MS2204, and MS2204VHD, use a #0 Phillips screwdriver; for the MS3204, use a #1 Phillips screwdriver.

4. Tilt the scanner bracket in the opposite direction to access the rear scanner mounting holes (which are aligned with the rear inserts on the bottom of the scanner), then insert the remaining two screws provided through the two rear mounting holes and into the scanner's threaded inserts.
5. Secure the mounting bracket to a flat surface by inserting 1/8" or smaller fasteners through the surface and into the bracket's mounting holes. There are four mounting holes on the bottom of the mounting bracket for horizontal mounting, and six holes on the side for vertical mounting.

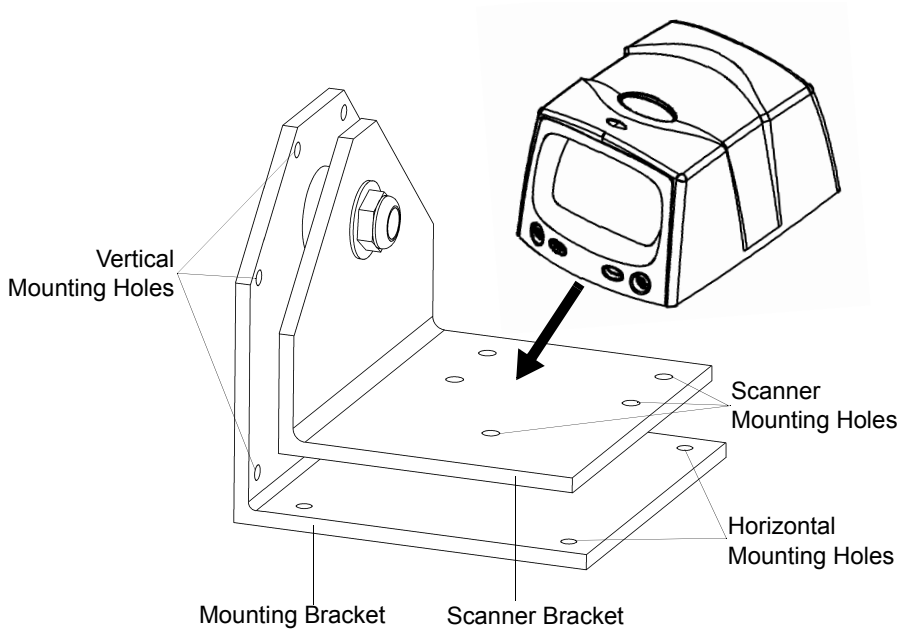

**Figure 2-6** *Mounting the Scanner and Bracket*

## Connecting the MiniScan

To connect the MiniScan to the host, connect the scanner cables in the order shown in [Figure 2-7](#).

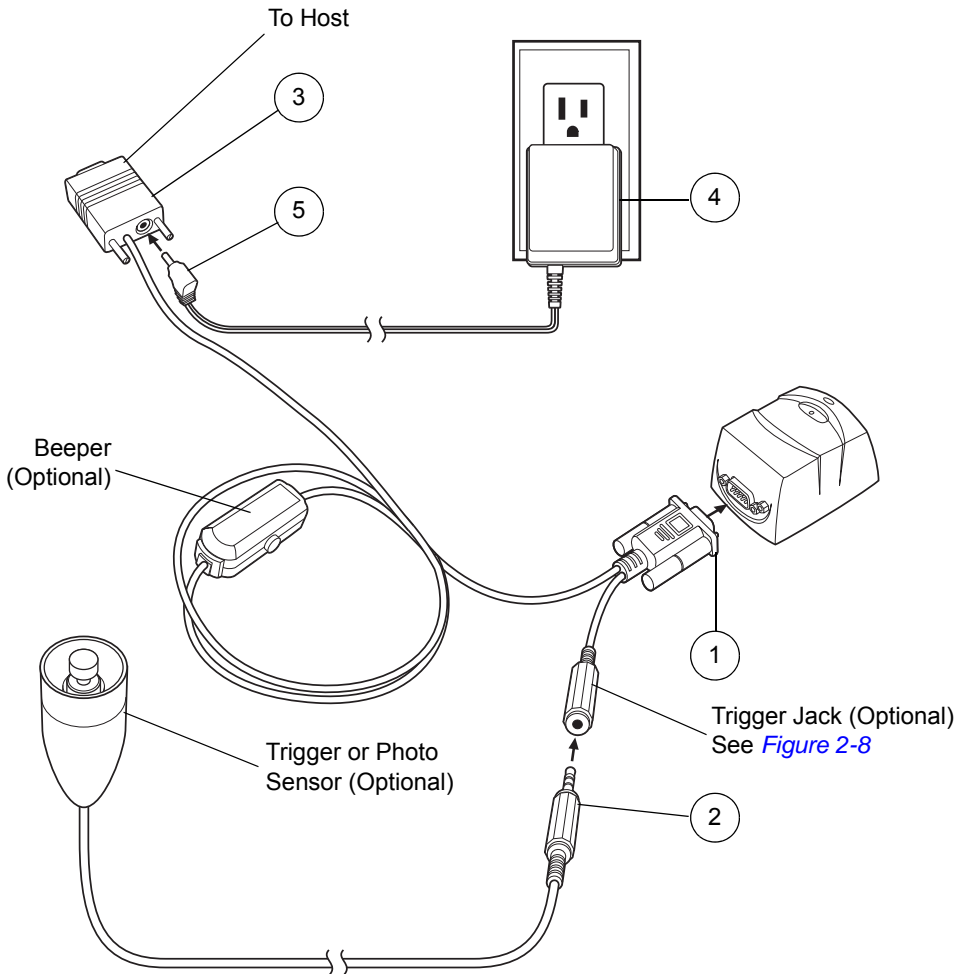

**Figure 2-7** Typical Connection Diagram

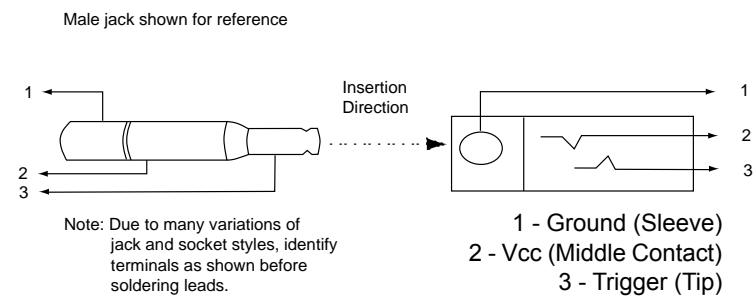

**Figure 2-8** Trigger Jack Connector Pins

## Connecting the MSXX04 via RS-232

Because Zebra scan engines use SSI communication protocol that requires hardware handshaking, you cannot use HyperTerminal in Microsoft Windows with the MSXX04. As an alternative, Zebra offers the SSI Demo program as a part of the SSISDK, available at no charge from the Zebra website. See [Simple Serial Interface Software Developer's Kit \(SSISDK\) on page 2-18](#). Use the SSI Demo program to quickly and easily trigger the MSXX04, scan a bar code, and view the data on the host screen.

After connecting the MSXX04 to the host, set up the SSI Demo:

1. Insert the SSI Demo CD into the host's CD drive and double-click on **setup.exe** to install the program.

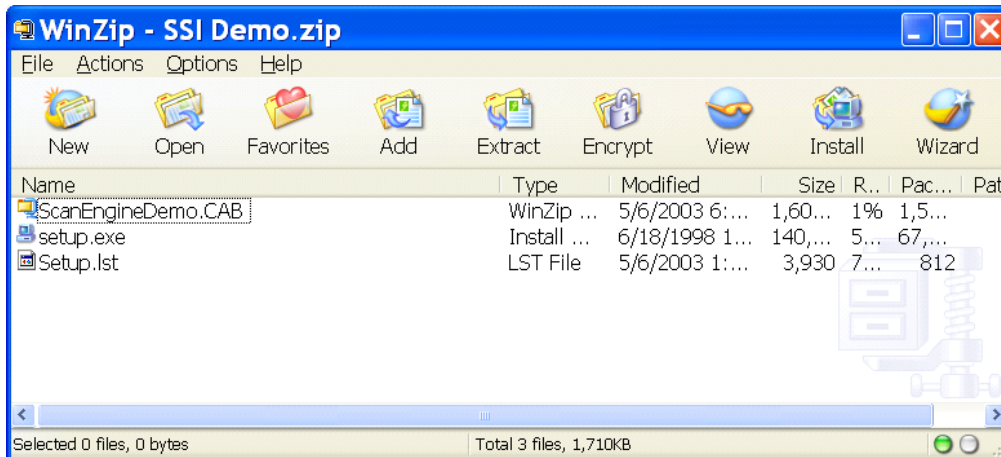

Figure 2-9 SSI Demo Installation Window

2. After extracting the files, select **Start -> SSI Engine Demo**.

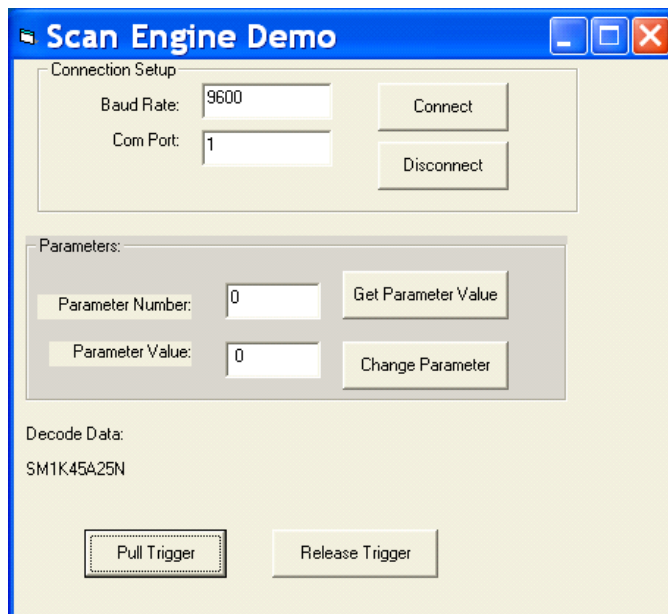

Figure 2-10 Scan Engine Demo Window

3. Click **Connect**.
4. Click **Pull Trigger** and view the decoded data in the bottom left-hand corner.



## Location and Positioning



**CAUTION** The following location and positioning guidelines do not consider unique application characteristics. Zebra recommends that an opto-mechanical engineer perform an opto-mechanical analysis prior to integration.



**NOTE** Integrate the scanner in an environment no more extreme than the product's specification, where the scanner will not exceed its temperature range. For instance, do not mount the scanner onto or next to a large heat source. When placing the scanner with another device, ensure there is proper convection or venting for heat. Follow these suggestions to ensure product longevity, warranty, and overall satisfaction with the scanner.

### Using the MiniScan as an Embedded Scanner

You can mount the MiniScan to read symbols automatically presented, or presented in a pre-determined location. In these applications, MiniScan positioning with respect to the symbol is critical. Failure to properly position the MiniScan can result in unsatisfactory scanning performance. Zebra also recommends a thermal analysis.

There are two methods of positioning the scanner:

- Use the [Calculating the Usable Scan Length Method on page 2-9](#) with consistently good quality symbols (see [page 2-10](#) for the MS954). This provides a mathematical solution to find the usable scan length.
- The [Testing the Usable Scan Length Method on page 2-11](#) uses real situation testing to adjust the usable scan length to fit the application conditions.

### Calculating the Usable Scan Length Method

Calculate usable scan length as follows (see [Figure 2-11 on page 2-10](#)):

$$L = 1.8 \times (D+d+B) \times \tan(A/2)$$

**Table 2-1** Calculation Constants

Constants	B	A
MS1204FZY (Default)	1.17	42°
MS1204FZY (Narrow Mode)	1.17	30°
MS2204	1.53	34°
MS2204VHD	1.53	34°
MS3204	1.93	34°

where:

D = Distance (in inches) from the front edge of the host housing to the bar code.

d = The host housing's internal optical path from the edge of the housing to the front of the MiniScan scanner.

B = Internal optical path from the scan mirror to the front edge of the MiniScan scanner.

A = Scan angle in degrees.

✓ **NOTE** This formula determines usable scan length, or 90% of scan line at any working distance. This formula is based on good quality symbols in the center of the working range and length of bar code.

### Calculating the Usable Scan Length Method (MS954 Only)

Calculate the usable scan length as follows (see [Figure 2-11](#)):

$$L = 2.0 \times (D+d+B) \times \tan(A/2)$$

**Table 2-2** MS954 Calculation Constants

Constants	B	A
MS954	0.87	47°
MS954 (Narrow Mode)	0.87	35°

where:

D = Distance (in inches) from the front edge of the host housing to the bar code.

d = The host housing's internal optical path from the edge of the housing to the front of the MiniScan scanner.

B = Internal optical path from the scan mirror to the front edge of the MiniScan scanner.

A = Scan angle in degrees.

✓ **NOTE** The MS954 does not require a margin on either side of the bar code to decode. The 47° scan line provides identical scanning performance to older MiniScan devices (e.g., MS923) with a scan line of 53°.

Consider the width of the scan line at any given distance when designing a system.

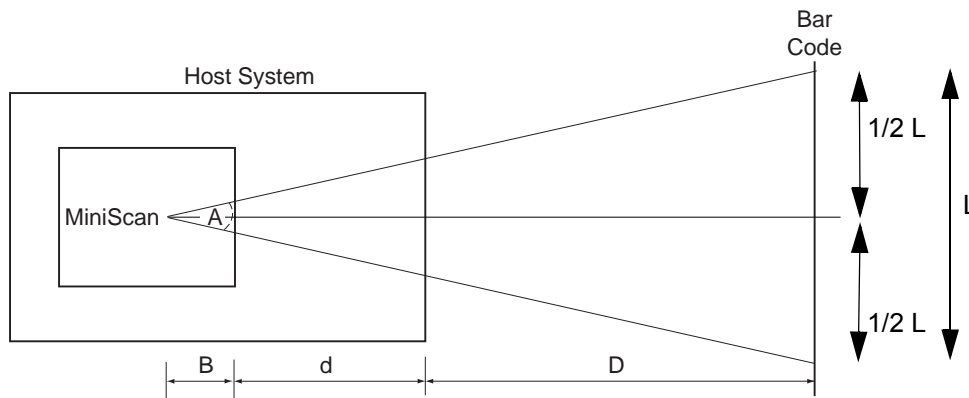

**Figure 2-11** Usable Scan Length Diagram

## Testing the Usable Scan Length Method

Due to the variety of symbol sizes, densities, print quality, etc., there is no simple way to calculate the ideal symbol distance. To optimize performance, use the *Testing The Usable Scan Length* positioning method:

1. Measure the maximum and minimum distances at which the MiniScan can read the symbols.
2. Check the near and far range on several symbols. If they are not reasonably consistent there may be a printing quality problem that can degrade the performance of the system. Zebra can provide advice on how to improve the installation.

✓ **NOTE** Poor quality symbols (from bad printing, wear, or damage) may not decode well when placed in the center of the depth of field (especially higher density codes). The scan beam has a minimum width in the central area, and when the scanner tries to read all symbol imperfections in this area it may not decode. After determining a preliminary spot using good quality symbols, test several reduced quality symbols and adjust the spot for the best overall symbol position.

3. Locate the scanner so the symbol is near the middle of the near/far range.
4. Center the symbol (left to right) in the scan line whenever possible.
5. Position the symbol so that the scan line is as near as possible to perpendicular to the bars and spaces in the symbol.
6. Avoid specular reflection (glare) off the symbol by tilting the top or bottom of the symbol away from the scanner. The exact angle is not critical, but it must be large enough so that if a mirror were inserted in the symbol location, the reflected scan line would miss the front surface of the scanner. For the maximum allowable angles refer to the Skew, Pitch and Roll angles listed in each MiniScan *Technical Specifications* table.
7. If placing an additional window between the scanner and the symbol, determine the optimum symbol location using a representative window in the desired window position.
8. Give the scanner time to dwell on the symbol for several scans. When first enabled, the MiniScan may take two or three scans before it reaches maximum performance. Enable the MiniScan before presenting the symbol, if possible.

## Conveyor Applications

Conveyor applications require setting the conveyor velocity to optimize the scanner's ability to read symbols. Also consider the orientation of the symbol with respect to the conveyor direction. [Figure 2-12 on page 2-12](#) illustrates the relationship of the conveyor velocity with respect to a symbol positioned perpendicular to the conveyor direction and [Figure 2-13 on page 2-13](#) illustrates the relationship of the conveyor velocity with respect to a symbol positioned parallel to the conveyor direction.

### Symbol is Perpendicular to Conveyor Movement

With the symbol bars perpendicular to the conveyor belt direction (Picket Fence presentation) the relationship is:

$$V = (R \times (F - W)) / N$$

where: V = Velocity of the conveyor (inches/second)

R = Scan Rate (see technical specifications)

F = 80% of width of scan beam

W = Symbol Width (inches)

N = Number of scans over symbol (minimum of 10 scans)

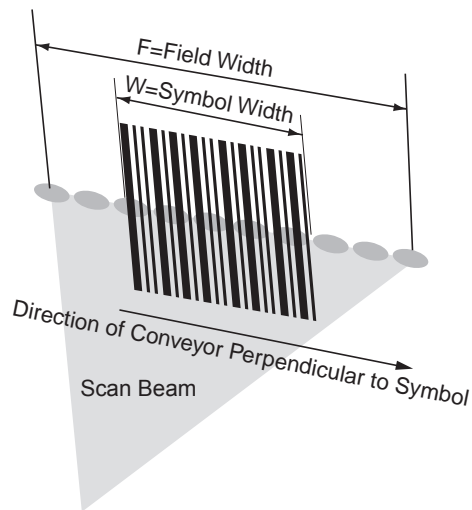

**Figure 2-12** *Symbol Perpendicular To Conveyor Movement*

### Example

R = 640 scans per second

F = 80% of 6 in.

W = 4 in.

N = 10

$V = (640 \times ((0.8 \times 6) - 4)) / 10 = 51.2 \text{ in./sec}$

### Symbol is Parallel to Conveyor Movement

With the symbol bars parallel to the conveyor belt direction (ladder presentation) the relationship is:

$$V = (R \times H) / N$$

where: V = Velocity of the conveyor (inches/second)

R = Scan Rate of scanner (see technical specifications)

H = Symbol height

N = Number of scans over symbol (minimum of 10 scans)

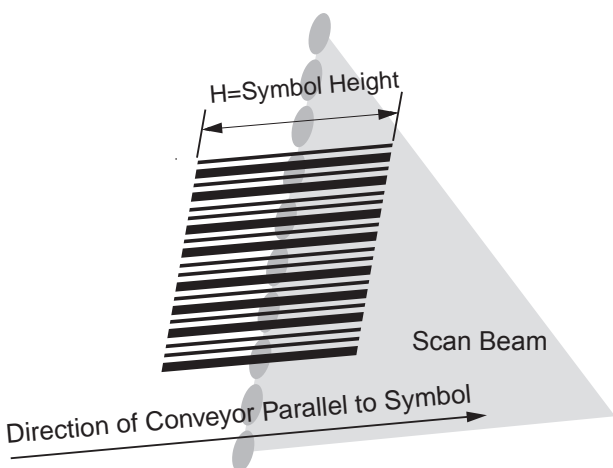

**Figure 2-13** Symbol Parallel To Conveyor Movement

#### Example

Use the previous formula to calculate the number of scans for a specific bar code, scanner, and conveyor speed; **a minimum of 10 scans per symbol is recommended.**

$$R = 640 \text{ scans/sec}$$

$$H = 60 \text{ mil}$$

$$N = 10 \text{ scans}$$

$$V = (640 \times .060) / 10 = 3.84 \text{ in./sec}$$

### Embedded Applications Requiring a Window

Use the following guidelines for applications that require a window in front of the MiniScan.

- ✓ **NOTE** Zebra does not recommend placing an exit window in front of the MiniScan; however, the following information is provided for applications that require such a window.

#### Window Material

Many window materials that look perfectly clear can contain stresses and distortions that can reduce scanner performance. For this reason, Zebra highly recommends using only optical glass or cell-cast acrylic with an anti-reflection coating. Following is a description of acrylic, and CR-39, another popular window material.

[Table 2-3 on page 2-14](#) outlines the suggested window properties.



**CAUTION** Consult an opto-mechanical engineer to recommend an appropriate window material and to determine if coatings are appropriate for the specific application.



**NOTE** Do not use polycarbonate material.

### **Acrylic**

When fabricated by cell-casting, acrylic has very good optical quality and low initial cost. However, protect the surface from the environment as acrylic is susceptible to attack by chemicals, mechanical stresses, and UV light. Acrylic has reasonably good impact resistance and can be ultrasonically welded.

### **CR-39**

CR-39 is a thermal-setting plastic produced by the cell-casting process, and is commonly used in plastic eye glasses lenses. CR-39 has excellent chemical and environmental resistance, including good surface hardness. Typically it does not require hard-coating, but can be hard coated for severe environments. CR-39 has reasonably good impact resistance and cannot be ultrasonically welded.

### **Chemically Tempered Float Glass**

Glass is a hard material which provides excellent scratch and abrasion resistance. However, unannealed glass is brittle. Increasing flexibility strength with minimal optical distortion requires chemical tempering. Glass cannot be ultrasonically welded and is difficult to cut into odd shapes.

**Table 2-3** *Suggested Window Properties*

<b>Property</b>	<b>Description</b>
Material	Red cell-cast acrylic.
Spectral Transmission	85% minimum from 640 to 690 nanometers.
Thickness	0.059 ± 0.005
Wavefront Distortion (transmission)	0.2 wavelengths peak-to-valley maximum over any 0.08 in. diameter within the clear aperture.
Clear Aperture	To extend to within 0.04 in. of the edges all around.
Surface Quality	60-20 scratch/dig
Coating	Both sides to be anti-reflection coated to provide 0.5% max reflectivity (each side) from 640 to 690 nanometers at nominal window tilt angle. Coatings must comply with the hardness adherence requirements of MIL-M-13508.

## Window Coatings

*Table 2-4* lists some exit window manufacturers and anti-reflection coaters.

### ***Anti-Reflection Coatings***

Apply an anti-reflection coating to the inside and/or outside of the window to significantly reduce the amount of light reflected off the window, back into the scan engine. The coating can also improve the range of acceptable window positions and minimize performance degradation due to signal loss as the light passes through the window. Zebra highly recommends using anti-reflection coatings on both the inside and outside of the window.

### ***Polysiloxane Coating***

Polysiloxane type coatings are applied to plastic surfaces to improve the surface resistance to both scratch and abrasion. They are usually applied by dipping, then air-drying in an oven with filtered hot air.

**Table 2-4** *Window Manufacturers and Coaters*

<b>Company</b>	<b>Discipline</b>	<b>Specifics</b>
Evaporated Coatings, Inc. 2365 Maryland Road Willow Grove, PA 19090 (215) 659-3080	Anti-reflection coater	Acrylic window supplier Anti-reflection coater
Fosta-Tek Optics, Inc. 320 Hamilton Street Leominster, MA 01453 (978) 534-6511	Cell-caster, hard coater, laser cutter	CR39 exit window manufacturer
Glasflex Corporation 4 Sterling Road Sterling, NJ 07980 (908) 647-4100	Cell-caster	Acrylic exit window manufacturer
Optical Polymers Int. (OPI) 110 West Main Street Milford, CT 06460 (203)-882-9093	CR-39 cell-caster, coater, laser cutter	CR39 exit window manufacturer
Polycast 70 Carlisle Place Stamford, CT 06902 800-243-9002	acrylic cell-caster, hard coater, laser cutter	Acrylic exit window manufacturer
TSP 2009 Glen Parkway Batavia, OH 45103 800-277-9778	acrylic cell-caster, coater, laser cutter	Acrylic exit window manufacturer

### Embedded Window Angle and Position

If placing a window between the MiniScan and the item to scan, observe the following guidelines:

- **Window Clear Opening** - Make the clear opening of the window large enough so that the entire scan beam passes through the window. Cutting off any part of the beam can result in internal reflections and degrade decode range performance. Ensure that window placement relative to the MiniScan accounts for tolerances on all parts involved in the assembly.
- **Window Angle** - Angle the window at least  $2^{\circ}$  more than the tilt of the window on the scanner (see [Table 2-5](#)). Further tilting the window is acceptable and decreases the possibility of a secondary reflection from that window degrading the scanner's performance.
- **Optical Working Range** - Adding a window can reduce the working range of the scanner since there is a signal loss when passing through window material. To minimize this reduction, use a special coating described in [Window Coatings on page 2-15](#). To understand the difference, test the scanner in the desired orientation and see if the difference affects scanner performance.

**Table 2-5** Secondary Window Angles

MiniScan Model	MiniScan Exit Window Angle from Vertical	Minimum Secondary Window Angle from Vertical
MS954	$28^{\circ}$	$30^{\circ}$
MS1204FZY, MS2204, MS2204VHD	$30^{\circ}$	$32^{\circ}$
MS3204	$35^{\circ}$	$37^{\circ}$



---

## Accessories

Zebra's Solution Builder (ordering guide) offers the following accessories for the MiniScan scanner.

- For power connection
  - Use Power Supply 50-14000-253R, -256R, -257, -258R, -259R, or PWRS-14000-253R, -256R, -257, -258R, -259R; Input Rated 100-240V, Output Rated 5Vdc, 850mA
- RS-232
  - Female DB9 with straight connector to RS-232 host (female DB9), with trigger jack and no beeper, p/n 25-13227-XX
  - Female DB9 with straight connector to RS-232 host (female DB9), with trigger jack and beeper, p/n 25-13228-XX
  - Female DB9 with straight connector to RS-232 host (female DB9), p/n 25-58918-XX
  - Female DB9 with right angle connector to RS-232 host (female DB9), p/n 25-58919-XX
  - Female DB9 with straight connector to RS-232 host (female DB9), with trigger jack and no hardware handshaking, p/n 25-63736-XX
- Cable Adapters
  - Female 25 pin D, TxD on pin 2, p/n 50-12100-378
  - Female 25 pin D, TxD on pin 3, p/n 50-12100-377
  - Male 25 pin D, TxD on pin 2, p/n 50-12100-380
  - Male 25 pin D, TxD on pin 3, p/n 50-12100-379
- Optional Accessories
  - Push button trigger cable, p/n 25-04950-01R
  - Photo sensor trigger cable, p/n 25-13176-01R (retroreflective, IR 850 nm, 7 foot range)
  - Fixed-mount stand, p/n 20-60136-01R
  - Mounting bracket, p/n KT-65578-01R

## **Simple Serial Interface Software Developer's Kit (SSISDK)**

The Software Developer's Kit, available from Zebra's website, provides the software tools required to integrate and communicate with the MiniScan scanners, including:

- Sample Windows<sup>®</sup> program with source code
- DLL with source code for building user applications
- ActiveX component (including help file) for easy integration into VisualBasic programs
- Simple Serial Interface documentation.

With over 70 programmable parameters, you can configure MiniScan scanners by scanning bar code menus, or through the serial interface using Zebra's Simple Serial Interface protocol.

For Windows<sup>®</sup>, DOS, and embedded system environments, this enables you to take full advantage of the scanner's features and obtain maximum performance.

# Chapter 3 Scanning

---

## Introduction

This chapter provides information on scan patterns, scanning, triggering options, and beeper and LED definitions.

---

## MiniScan Scan Patterns

### MS1204FZY / MS954 Scan Pattern

MS1204FZY and MS954 scanners emit a single scan line to quickly decode 1D bar codes.

---

**Figure 3-1** *Single Scan Line Scan Pattern*

## MS2204 and MS2204VHD Scan Patterns

The MS2204 and MS2204VHD generate different scan patterns (Smart Raster and High Density Single Scan Line) based on the software command received at the interface. You can use the raster pattern to read 1D bar codes and PDF417 symbols.



**NOTE** The MS2204 and MS2204VHD also support omnidirectional and semi-omnidirectional scan patterns, but are not optimized for these patterns.

### Smart Raster Scan Pattern

The MS2204 and MS2204VHD can create a single line which opens vertically to read PDF417 symbols using the Smart Raster feature. This feature autodetects the type of bar code being scanned and adjusts its pattern accordingly, providing optimal performance on 1D, PDF417, GS1 DataBar, and Composite codes.

Stage 1: "Slab" Raster Pattern



Stage 2: Open Raster Pattern

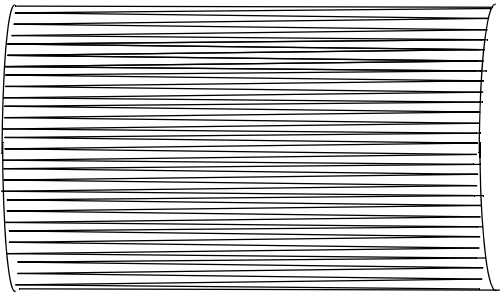

**Figure 3-2** *Raster Scan Pattern*

### High Density Single Scan Line Scan Pattern

The High Density single scan line appears as a "mini" raster and scans multiple areas of 1D codes to swiftly and accurately capture data on poorly printed and damaged bar codes.



**Figure 3-3** *High Density Single Scan Line Scan Pattern*

## MS3204 Scan Patterns

The MS3204 generates four scan patterns based on the software command received at the interface. These patterns are Smart Raster, Semi-omnidirectional, Omnidirectional, and High Density Single Scan Line. You can use the raster pattern to read 1D bar codes and PDF417 symbols. The omnidirectional pattern reads 1D bar codes in an omnidirectional manner.

### Smart Raster Scan Pattern

The MS3204 can create a single line which opens vertically to read PDF417 symbols using the Smart Raster feature. This feature autodetects the type of bar code being scanned and adjusts its pattern accordingly, providing optimal performance on 1D, PDF417, GS1 DataBar, and Composite codes.

Stage 1: "Slab" Raster Pattern



Stage 2: Open Raster Pattern

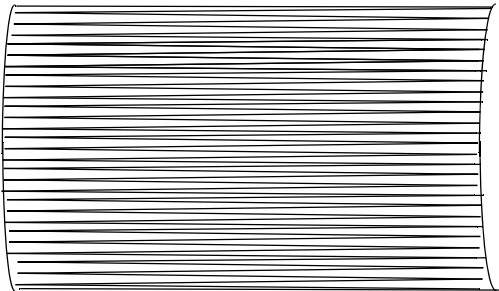

**Figure 3-4** *Raster Scan Pattern*

### Semi-omnidirectional Scan Pattern

The semi-omnidirectional pattern is an alternative to the full omnidirectional pattern that scans highly truncated 1D and GS1 DataBar bar codes. Present bar codes horizontally with no more than a 20° tilt.

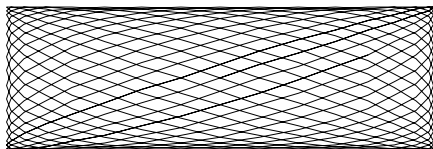

**Figure 3-5** *Semi-omnidirectional Scan Pattern*

### Omnidirectional Scan Pattern

The high-speed rotating omnidirectional scan pattern provides aggressive performance on 1D bar codes because there are no “holes” in the pattern. This ensures fast throughput at the point of activity and the ability to read 1D symbols in 360° of rotation, eliminating the need to orient the bar code in the field of view.

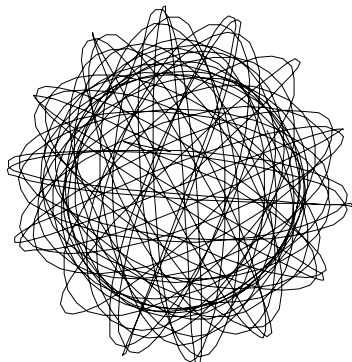

**Figure 3-6** *Omnidirectional Scan Pattern*

### High Density Single Scan Line Scan Pattern

The high density single scan line appears as a "mini" raster and scans multiple areas of 1D codes to swiftly and accurately capture data on poorly printed and damaged bar codes.



**Figure 3-7** *High Density Single Scan Line Scan Pattern*

---

## Scan Angle Selection

The MS1204FZY and MS954 scanners support two pre-set scan angles (see each scanner's technical specifications).

### Selecting Scan Angle via SSI

To use SSI to select the scan angle, issue the SSI PARAM\_SEND command with the NUM\_SCAN\_ANGLE (191) parameter number. This is set to the default angle (182), or you can select the alternate angle (181). See the *Simple Serial Interface (SSI) Programmer's Guide* (p/n 72-40451-xx) for more information.

### Selecting Scan Angle via Parameter Bar Code

You can also set the scan angle by scanning a parameter bar code (see [Scan Angle on page 10-18](#)). Scanning the parameter bar code retains that scan angle setting.

### Operation in Blink Mode

The scan angle system parameter determines the scan angle during Blink Mode.

---

## Scanning Tips

When scanning, make sure the symbol to scan is within the scanning range. See [Calculating the Usable Scan Length Method on page 2-9](#). Align the bar code with the scan beam. The green decode LED lights to indicate a successful decode.

### Scan the Entire Symbol

- The scan beam must cross every bar and space on the symbol.
- The larger the symbol, the farther away the scanner should be positioned.
- Position the scanner closer for symbols with bars that are close together.

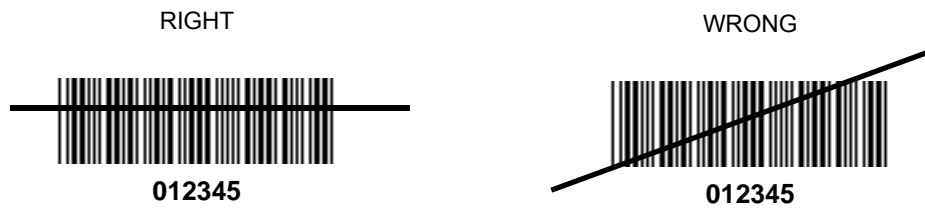

### Position at an Angle

Do not position the scanner exactly perpendicular to the bar code. In this position, light can bounce back into the scanner's exit window and prevent a successful decode.

---

## Trigger Options

### Continuous

The laser is enabled continuously and decode processing is continuously active. You can configure the scanner to scan and transmit a bar code, and then not decode the same bar code or any bar code for a set period of time. See [Timeout Between Decodes on page 10-25](#) to customize the application to the rate at which bar codes are presented.



**Continuous**



**NOTE** This option is not recommended during scanner programming via bar code menus.

## Level Trigger

The laser is enabled and decode processing begins when the trigger line activates. Decode processing continues until a good decode occurs, the trigger is released, or the Laser On Time expires. The laser is disabled once decode processing completes. The next decode attempt does not occur until the trigger line is released and then reactivated.



**Level**

## Pulse Trigger

The laser is enabled and decode processing begins when the trigger line activates. Decode processing continues regardless of the trigger line until a good decode occurs, or until the Laser On Time expires. The laser is disabled once decode processing completes. The next decode attempt does not occur until the trigger line is released and then reactivated.



**Pulse**

## Blink

✓ **NOTE** Only the MS1204FZY and MS954 support this option.

The laser blinks at a 25% duty cycle (reduced to 10% after 30 seconds of inactivity), until a bar code is presented. When a bar code is presented, the laser remains on until either the bar code is decoded or removed, or the session timeout expires. Once it decodes the bar code, the scanner does not decode it again until the bar code is removed.



**Blink**

## Host Trigger

An SSI Start Decode message from the host enables the laser and begins decode processing. Decode processing continues until a good decode occurs, an SSI Stop Decode message is received, or the Laser On Time expires. The laser is disabled once decode processing completes. The next decode attempt does not occur until the host sends the next Start Decode message.

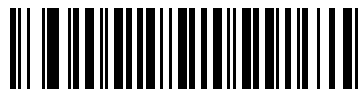

**Host**



## Beeper and LED Definitions

[Table 3-1](#) provides beeper definitions, and [Table 3-2](#) provides LED definitions.

**Table 3-1** *Beeper Definitions*

Beeper Sequence	Indication
<b>Standard Use</b>	
1 Beep - short high tone	A bar code symbol was decoded (if decode beeper is enabled).
1 Beep - long high tone	Thermal shutdown.
3 Beeps - short high tone (MS2204/2204VHD/3204 only)	Power-on or reset. Occurs immediately after the scanner turns on, indicating that the system software is working properly. If three beeps occur during normal operation, it is due to a reset and any work in progress is lost. If this occurs often, contact Zebra Support.
<b>Parameter Menu Scanning</b>	
2 Beeps - short high tone	Correct entry scanned or correct menu sequence performed.
1 Beep - hi/lo/hi/lo tone	Successful program exit with change in the parameter setting.
2 Beeps - lo/hi tone	Input error, incorrect bar code, or <b>Cancel</b> scanned, wrong entry, incorrect bar code programming sequence; remain in program mode.
<b>Communication</b>	
4 Beeps - short high tone	Communication error.
4 Beeps - hi/hi/hi/lo	Receive error.
3 Beeps - lo/hi/lo	ADF transmit error.

**Table 3-2** *LED Definitions*

LED	Indication
Red	Scanner is on.
Green	A bar code was successfully decoded.



# Chapter 4 MS1204FZY Specifications

---

## Introduction

This chapter provides the technical specifications for the MS1204FZY scanner.

---

## MS1204FZY Electrical Interface

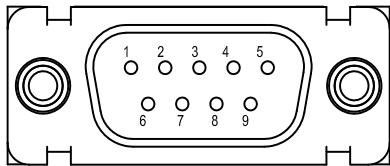

**Figure 4-1** *MiniScan Connector*

Table 4-1 lists the pin functions of the MS1204FZY interface.

**Table 4-1** MS1204FZY Electrical Interface

Pin No.	Pin Name	Type*	Function
1	Trigger	I	Signals scanner to begin scanning session.
2	TXD	O	Serial data transmit output. Drives the serial data receive input on the device communicating with the scanner.
3	RXD	I	Serial data receive input. Driven by the serial data transmit output on the device communicating with the scanner.
4	Not used		
5	Ground		Power supply ground input and signal ground reference.
6	Power	I	5.0 VDC $\pm$ 10%
7	CTS	I	Clear-to-send handshaking input line, used only in conjunction with the RTS line. Optionally used by another device to signal the scanner to begin transmitting data.
8	RTS	O	Request-to-send handshaking output line, used only in conjunction with the CTS line. Optionally used by the scanner to signal another device that data is available to send.
9	Beeper/Download	I/O	During normal operation this signal functions as an external beeper drive line. This signal can sink 50 mA of current to drive an external beeper, and is normally pulled up. This signal is also used to begin Flash Download operation when grounded externally during power up.

**\*I = Input O = Output**

# MS1204FZY Mechanical Drawings

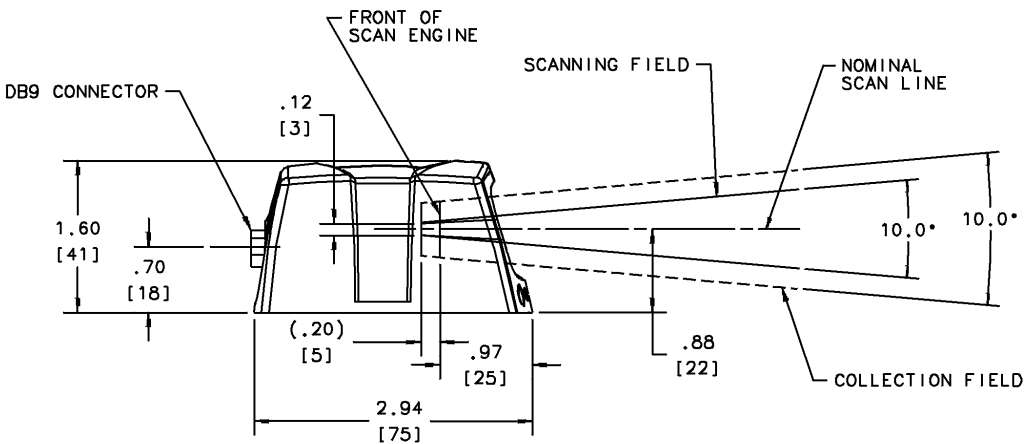

Notes:

Unless otherwise specified:

- Dimensions are in inches, dimensions in [ ] are mm.
- User mounting tolerances are not included.

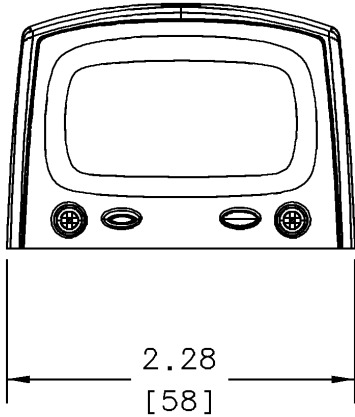
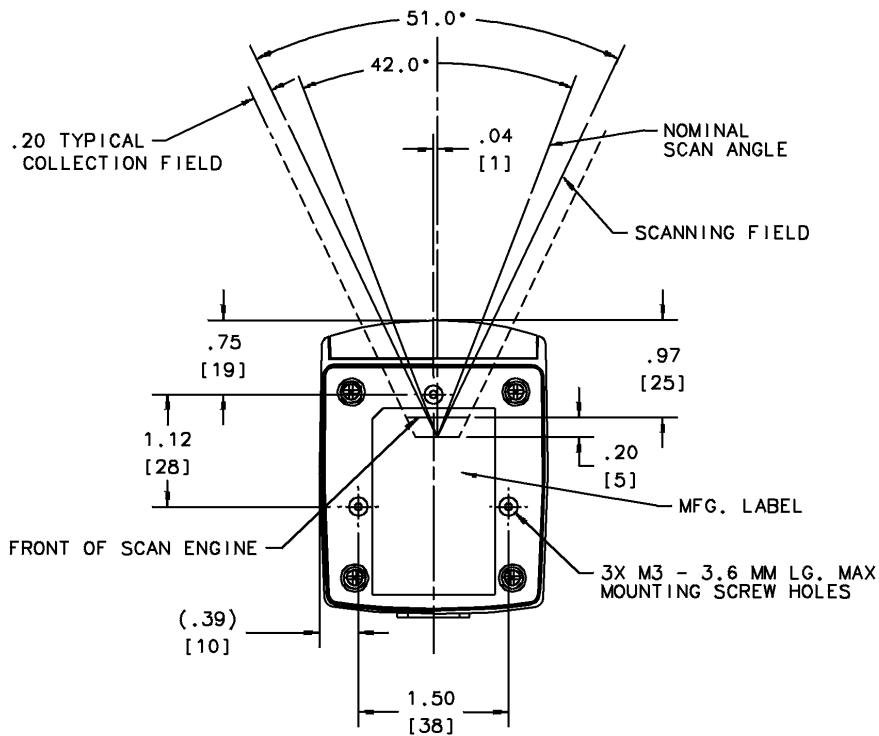

Figure 4-2 MS1204FZY Mechanical Drawing



Notes:

Unless otherwise specified:

- Dimensions are in inches, dimensions in [ ] are mm.
- User mounting tolerances are not included.

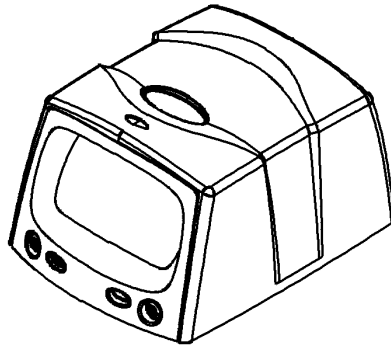

Figure 4-3 MS1204FZY Mechanical Drawing

## MS1204FZY Technical Specifications

Table 4-2 provides the MS1204FZY technical specifications.

**Table 4-2** MS1204FZY Technical Specifications @ 23°C

Item	Description
Power Requirements	
Input Voltage	5.0 VDC $\pm$ 10%
Scanning Current	160 mA $\pm$ 40 mA
Standby Current	20 mA $\pm$ 5 mA typical
V <sub>cc</sub> Noise Level	200 mV peak-to-peak max.
Laser Power	1.0 mW $\pm$ 0.12 mW, $\lambda$ = 650 nm nominal
Scan Rate	36 ( $\pm$ 5) scans/sec (bidirectional)
Print Contrast	Minimum 25% absolute dark/light reflectance measured at 650 nm.
Scan Angle	Default (Wide): 42° $\pm$ 2° Alternate (Narrow): 30° $\pm$ 2°
Scan Pattern	Single scan line
Skew Tolerance	$\pm$ 50° from normal (see <a href="#">Figure 4-4 on page 4-6</a> )
Pitch Angle	$\pm$ 65° from normal (see <a href="#">Figure 4-4 on page 4-6</a> )
Roll	$\pm$ 20° from vertical (see <a href="#">Figure 4-4 on page 4-6</a> )
Decode Depth of Field	See <a href="#">Figure 4-5 on page 4-7</a>
Ambient Light Immunity	
Sunlight	8,000 ft. candles (86,112 lux)
Artificial Light	450 ft. candles (4,844 lux)
Drop	Multiple 30" drops
Vibration	Unpowered scanner withstands a random vibration along each of the X, Y and Z axes for a period of one hour per axis, defined as follows: 20 to 80 Hz      Ramp up to 0.04 G <sup>2</sup> /Hz at the rate of 3dB/octave. 80 to 350 Hz    0.04 G <sup>2</sup> /Hz 350 to 2000 Hz   Ramp down at the rate of 3 dB/octave.
ESD	$\pm$ 20kV air discharge $\pm$ 8kV indirect discharge
Sealing	IP54
Operating Temperature	-4° to 122°F (-20° to 50°C)
Storage Temperature	-40° to 158°F (-40° to 70°C)
Humidity	5% to 95% non-condensing

**Note: Environmental and/or tolerance parameters are not cumulative.**

**Table 4-2** MS1204FZY Technical Specifications @ 23°C (Continued)

Item	Description
Laser Class	CDRH Class II, IEC Class 2
Height	1.60 in. (4.06 cm)
Width	2.28 in. (5.79 cm)
Depth	2.94 in. (7.47 cm)
Weight	4.45 oz. (126 gm)

**Note: Environmental and/or tolerance parameters are not cumulative.**

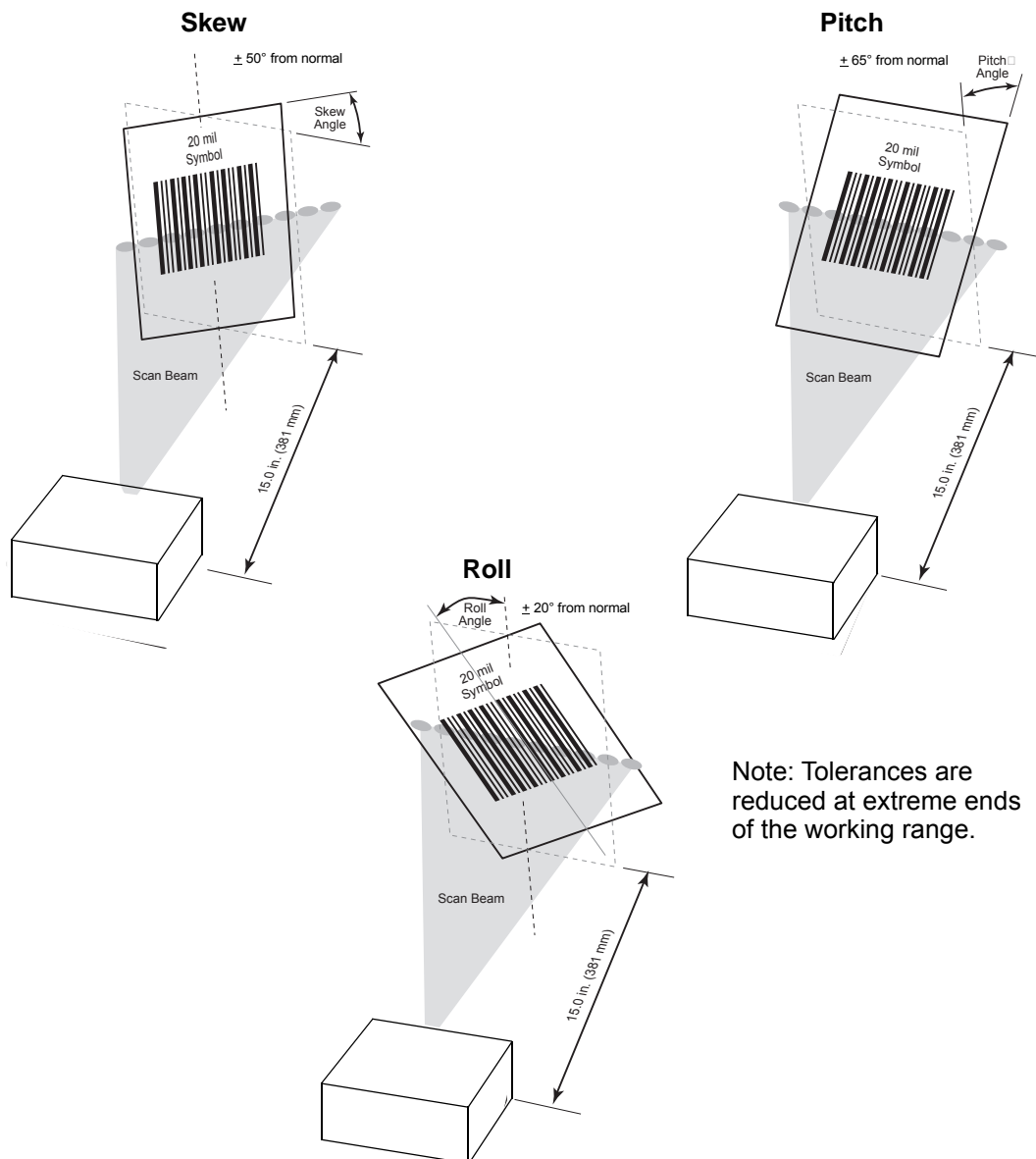
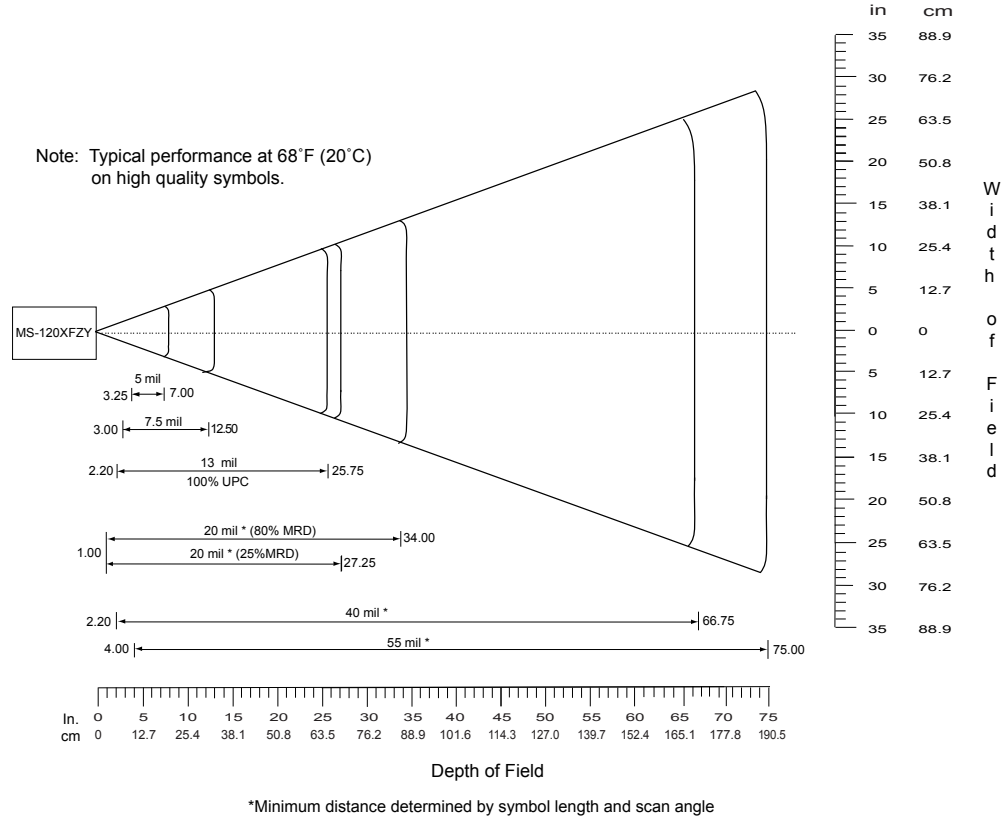

**Figure 4-4** Skew, Pitch and Roll



# MS1204FZY Decode Zone

The scanner offers a scan angle of either 30° or 42°. *Figure 4-5* shows the 42° symbol decode ranges. These figures are typical values. *Table 4-3 on page 4-8* lists the typical and guaranteed distances for the 42° scan angle for selected bar code densities. The minimum element width (or “symbol density”) is the width in mils of the narrowest element (bar or space) in the symbol. The maximum usable length of a symbol at any given range appears below. To calculate this distance, see *Calculating the Usable Scan Length Method on page 2-9*.



**Figure 4-5** MS1204FZY Typical Decode Zone (42° Scan Angle)

**Table 4-3** MS1204FZY Decode Distances (42° Scan Angle)

Symbol Density/ p/n / Bar Code Type / W-N Ratio	Bar Code Content/ Contrast <sup>1</sup>	Typical Working Ranges <sup>3</sup>		Guaranteed Working Ranges <sup>3</sup>	
		Near	Far	Near	Far
5.0 mil 64-17453-01 Code 39; 2.5:1	ABCDEFGH 80% MRD	3.25 in. 8.26 cm	7.00 in. 17.78 cm	4.75 in. 12.07 cm	5.25 in. 13.34 cm
7.5 mil 64-17452-01 Code 39; 2.5:1	ABCDEF 80% MRD	3.00 in. 7.62 cm	12.50 in. 31.75 cm	4.75 in. 12.07 cm	9.00 in. 22.86 cm
13 mil 64-05303-01 100% UPC	012345678905 80% MRD	2.20 in. 5.59 cm	25.75 in. 65.41 cm	Note 2	19.00 in. 48.26 cm
20 mil 60-01429-01 Code 39; 2.2:1	123 80% MRD	1.00 in. 2.54 cm (Note 2)	34.00 in. 86.36 cm	Note 2	24.00 in. 60.96 cm
20 mil 60-02710-01 Code 39; 2.2:1	123 25% MRD	1.00 in. 2.54 cm (Note 2)	27.25 in. 69.22 cm	Note 2	22.00 in. 55.88 cm
40 mil 64-17457-01 Code 39; 2.2:1	AB 80% MRD	2.20 in. 5.59 cm (Note 2)	66.75 in. 169.55 cm	Note 2	49.00 in. 124.46 cm
55 mil 64-17458-01 Code 39; 2.2:1	CD 80% MRD	4.00 in. 10.16 cm (Note 2)	75.00 in. 190.50 cm	Note 2	55.00 in. 139.70 cm

**Notes:**

1. Contrast measured as Mean Reflective Difference (MRD) at 650 nm.
2. Near ranges on lower densities largely depend on the width of the bar code and the scan angle.
3. Working range specifications: Photographic quality symbols, pitch = 10°, skew = 0°, roll = 0°, ambient light < 150 ft. candles, and temperature = 23 °C.

## Usable Scan Length

The decode zone is a function of various symbol characteristics including density, print contrast, wide-to-narrow ratio, and edge accuracy. Consider the width of the scan line at any given distance when designing a system.

[Calculating the Usable Scan Length Method on page 2-9](#) describes how to calculate the usable scan length. [Table 4-2 on page 4-5](#) provides the scan angle.

# Chapter 5 MS2204 Specifications

---

## Introduction

This chapter provides the technical specifications for the MS2204 scanner.

---

## MS2204 Electrical Interface

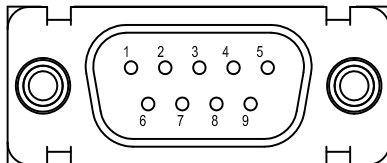

**Figure 5-1** *MiniScan Connector*

Table 5-1 lists the pin functions of the MS2204 interface.

**Table 5-1** MS2204 Electrical Interface

Pin No.	Pin Name	Type*	Function
1	Trigger	I	Signals scanner to begin scanning session.
2	TXD	O	Serial data transmit output. Drives the serial data receive input on the device communicating with the scanner.
3	RXD	I	Serial data receive input. Driven by the serial data transmit output on the device communicating with the scanner.
4	Not used		
5	Ground		Power supply ground input and signal ground reference.
6	Power	I	5.0 VDC $\pm$ 10%
7	CTS	I	Clear-to-send handshaking input line, used only in conjunction with the RTS line. Optionally used by another device to signal the scanner to begin transmitting data.
8	RTS	O	Request-to-send handshaking output line, used only in conjunction with the CTS line. Optionally used by the scanner to signal another device that data is available to send.
9	Beeper/Download	I/O	During normal operation this signal functions as an external beeper drive line. This signal can sink 50mA of current to drive an external beeper, and is normally pulled up. This signal is also used to begin Flash Download operation when grounded externally during power up.

**\*I = Input O = Output**

## MS2204 Mechanical Drawings

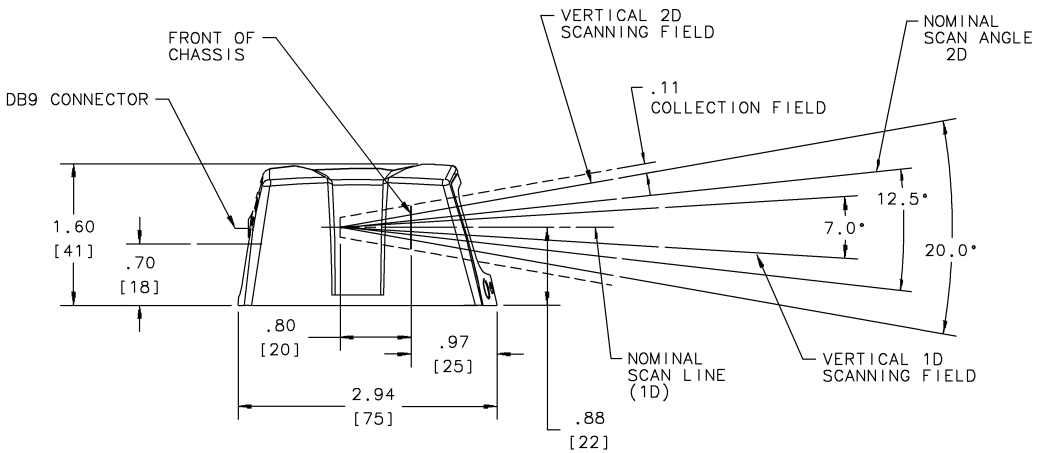

### Notes:

Unless otherwise specified:

- Dimensions are in inches, dimensions in [ ] are mm.
- User mounting tolerances are not included.

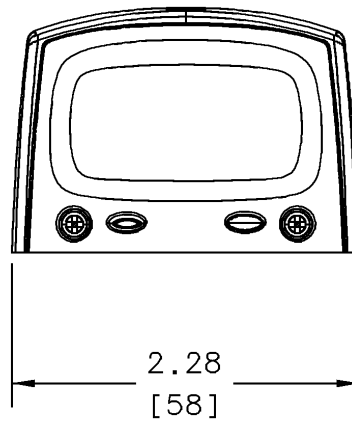
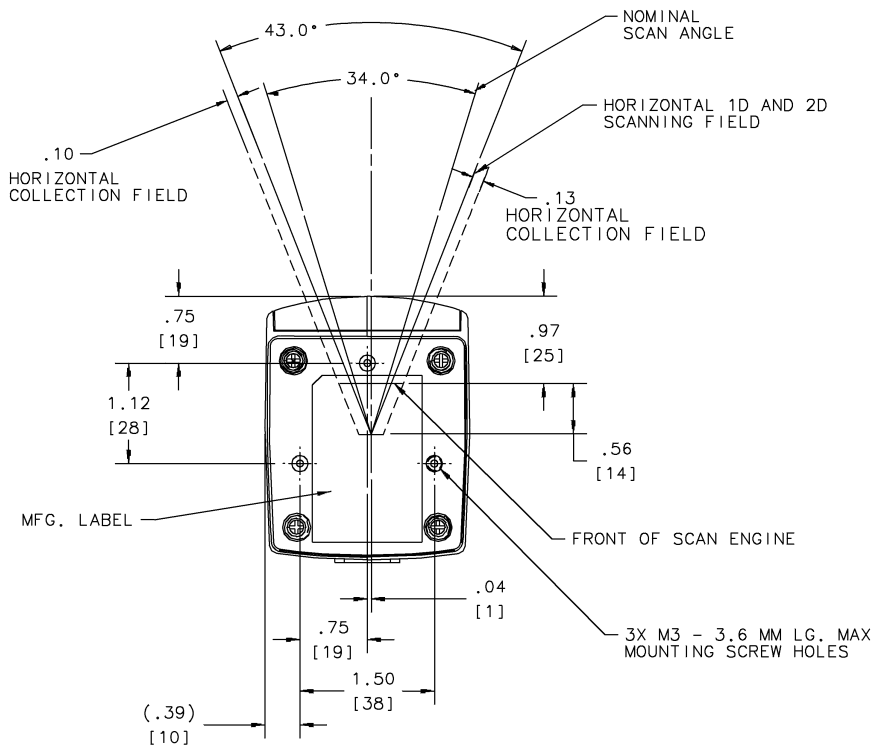

Figure 5-2 MS2204 Mechanical Drawing



Notes:

Unless otherwise specified:

- Dimensions are in inches, dimensions in [ ] are mm.
- User mounting tolerances are not included.

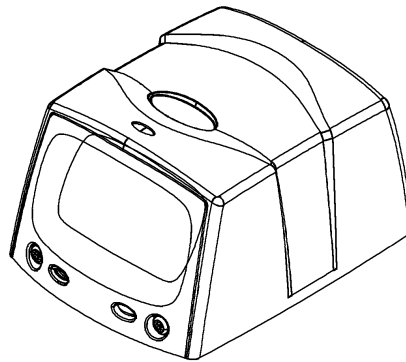

Figure 5-3 MS2204 Mechanical Drawing

## MS2204 Technical Specifications

[Table 5-2](#) provides the MS2204 technical specifications

**Table 5-2** MS2204 Technical Specifications @ 23°C

Item	Description
Power Requirements	
Input Voltage	5.0 VDC $\pm$ 10%
Scanning Current	250 $\pm$ 30 mA typical
Standby Current	25 $\pm$ 5 mA typical
V <sub>cc</sub> Noise Level	200 mV peak-to-peak max.
Laser Power	0.95 mW $\pm$ 0.1 mW, $\lambda$ = 650 nm nominal
Scan Rate	640 scans/sec.
Scan Frequency: Horizontal	320 Hz $\pm$ 5 Hz
Scan Frequency: Vertical	282 Hz $\pm$ 5 Hz
Frame Rate	24 frames/sec. 12 Hz $\pm$ 1 Hz (vertical)
Print Contrast	Minimum 35% absolute dark/light reflectance differential
Scan Angle	Horizontal: 34° $\pm$ 1.5° Vertical: 12.5° $\pm$ 1.5°
Scan Pattern	Smart raster, high density single scan line
Start Time	0.065 sec. to 75% of steady state horizontal amplitude
Skew Tolerance	$\pm$ 15° from plane parallel to symbol (see <a href="#">Figure 5-4 on page 5-7</a> )
Pitch Angle	$\pm$ 30° from normal (see <a href="#">Figure 5-4 on page 5-7</a> )
Roll	$\pm$ 4° from (for scanning benchmark label, assuming 3:1 codeword aspect ratio) (see <a href="#">Figure 5-4 on page 5-7</a> )
Decode Depth of Field	See <a href="#">Figure 5-5 on page 5-8</a> and <a href="#">Figure 5-6 on page 5-10</a>
Beam Deviation (offset from the nominal)	Horizontal: $\pm$ 3.0° Vertical: $\pm$ 3.0° Horizontal tilt: $\pm$ 2°
Ambient Light Immunity	
Sunlight	8,000 ft. candles (86,112 lux)
Artificial Light	450 ft. candles (4,844 lux)
Drop	Multiple 30" drops

**Table 5-2** MS2204 Technical Specifications @ 23°C (Continued)

Item	Description
Vibration	Unpowered scanner withstands a random vibration along each of the X, Y and Z axes for a period of one hour per axis, defined as follows: 20 to 80 Hz Ramp up to 0.04 G <sup>2</sup> /Hz at the rate of 3dB/octave. 80 to 350 Hz 0.04 G <sup>2</sup> /Hz 350 to 2000 Hz Ramp down at the rate of 3 dB/octave.
ESD	± 20kV air discharge ± 8kV indirect discharge
Sealing	IP54
Operating Temperature	-22° to 122°F (-30° to 50°C)
Storage Temperature	-40° to 158°F (-40° to 70°C)
Humidity	5% to 95% non-condensing
Laser Class	CDRH Class II, IEC Class 2
Height	1.60 in. (4.06 cm)
Width	2.28 in. (5.79 cm)
Depth	2.94 in. (7.47 cm)
Weight	4.73 oz. (134 gm)



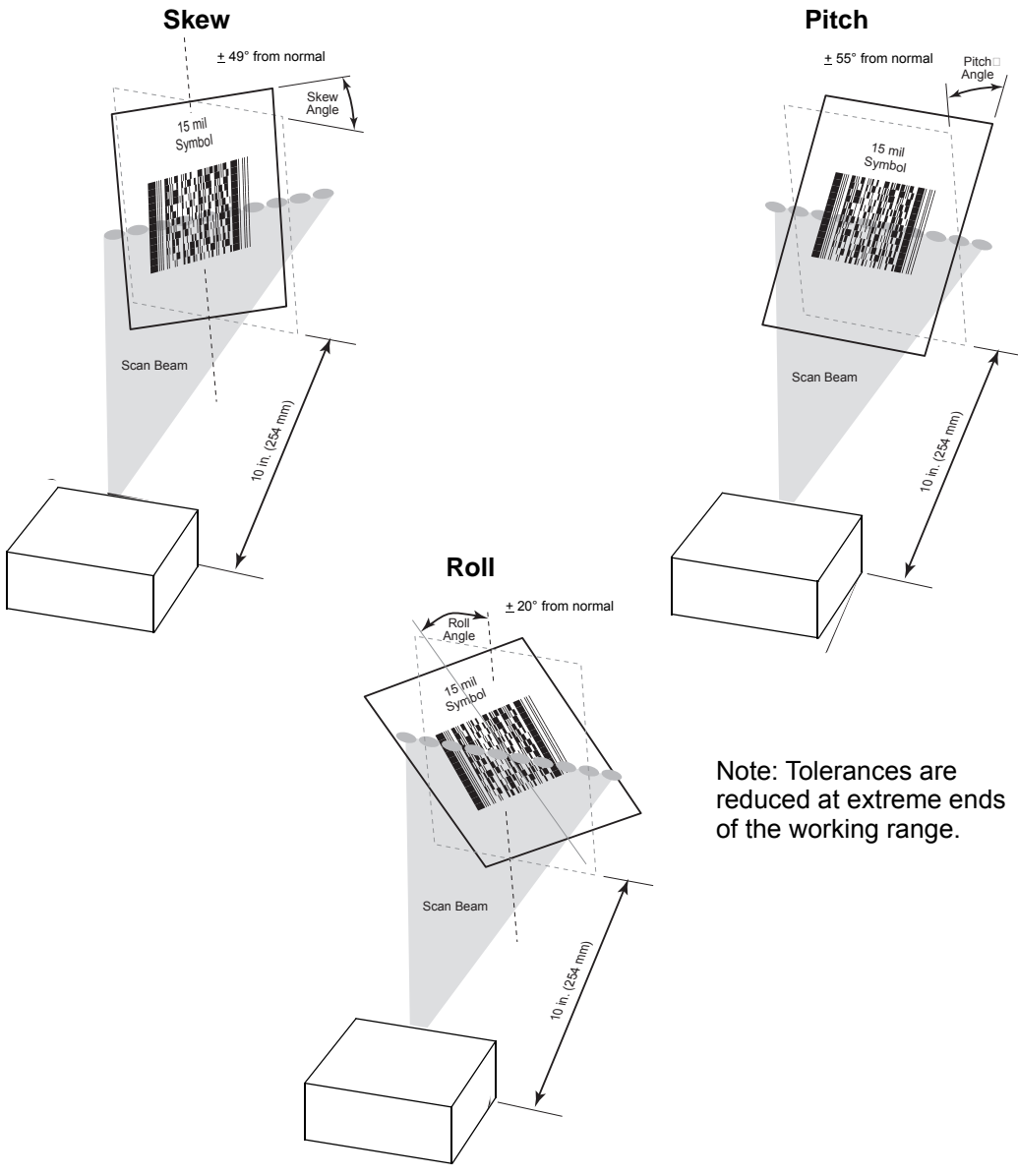

Figure 5-4 Skew, Pitch and Roll

## MS2204 Decode Zones

The decode zone is a function of various symbol characteristics including density, print contrast, wide to narrow ratio, and edge acuity. Typical values appear. [Table 5-3 on page 5-9](#) and [Table 5-4 on page 5-11](#) list the typical and guaranteed distances for selected bar code densities. The minimum element width (or “symbol density”) is the width in mils of the narrowest element (bar or space) in the symbol. The maximum usable length of a symbol at any given range appears below. To calculate this distance, see [Calculating the Usable Scan Length Method on page 2-9](#).

### MS2204 1D Decode Zone

Note: Typical performance at 68°F (20°C)  
on high quality symbols in normal room light.  
Vcc = 5V

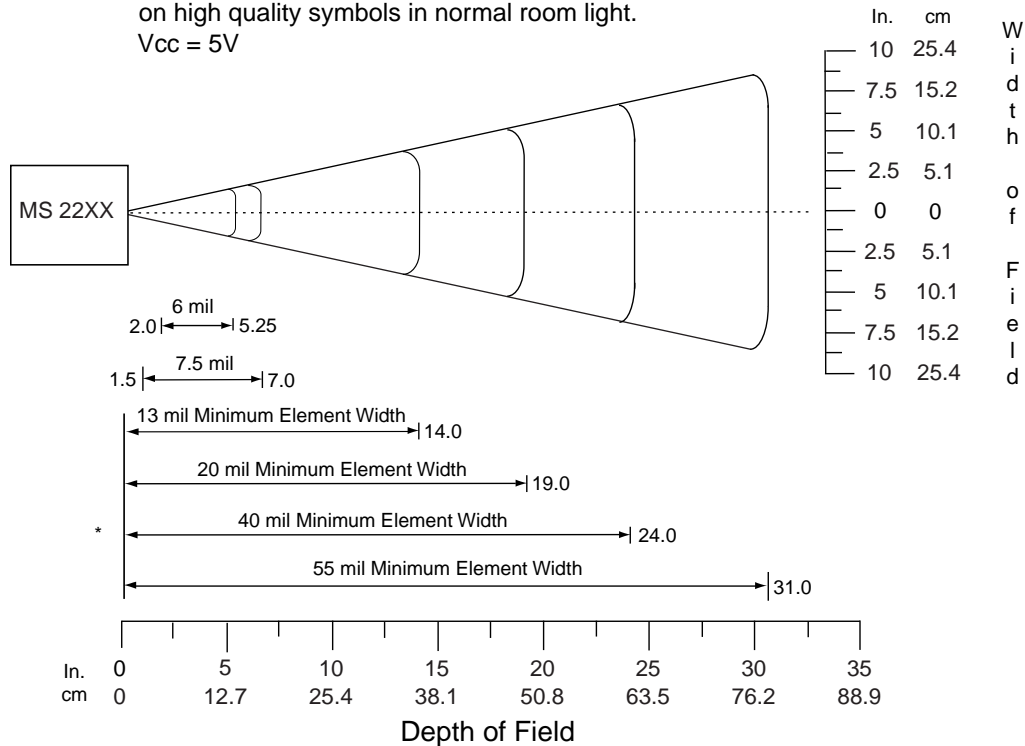

\* Minimum distance determined by symbol length and scan angle.

Figure 5-5 MS2204 1D Decode Distances

## MS2204 1D Decode Distances

**Table 5-3** MS2204 1D Decode Distances

Symbol Density/ p/n / Bar Code Type	Bar Code Content/ Contrast <sup>1</sup>	Typical Working Ranges <sup>3</sup>		Guaranteed Working Ranges <sup>3</sup>	
		Near	Far	Near	Far
6.0 mil 60-01755-01 Code 39	123 80% MRD	2.0 in. 5.08 cm	5.25 in. 13.34 cm	2.75 in. 7.00 cm	4.0 in. 10.16 cm
7.5 mil 64-17452-01 Code 39	ABCDEF 80% MRD	1.5 in. 3.81 cm	7.0 in. 17.78 cm	2.25 in. 5.72 cm	5.0 in. 12.7 cm
13 mil 64-05303-01 100% UPC	012345678905 80% MRD	Note 2	14.0 in. 35.56 cm	N/A	10.5 in. 26.67 cm
20 mil 64-17456-01 Code 39	123 80% MRD	Note 2	19.0 in. 48.26 cm	N/A	14.0 in. 35.56 cm
40 mil 64-17457-01 Code 39	AB 80% MRD	Note 2	24.0 in. 60.96 cm	N/A	18.0 in. 45.72 cm
55 mil 60-01601-01 Code 39	A 80% MRD	Note 2	31.0 in. 78.74 cm	Note 2	25.0 in. 63.50 cm

**Notes:**

**1. Contrast measured as Mean Reflective Difference (MRD) at 650 nm.**

**2. Near ranges on lower densities largely depend on the width of the bar code and the scan angle.**

**3. Working range specifications: Photographic quality symbols, pitch = 10°, skew = 0°, roll = 0°, ambient light < 150 ft. candles, and temperature = 23 °C.**

### MS2204 2D Decode Zone

Note: Typical performance at 68°F (20°C) on high quality symbols in normal room light. Y-module dimension = 3X.  
Vcc = 5V

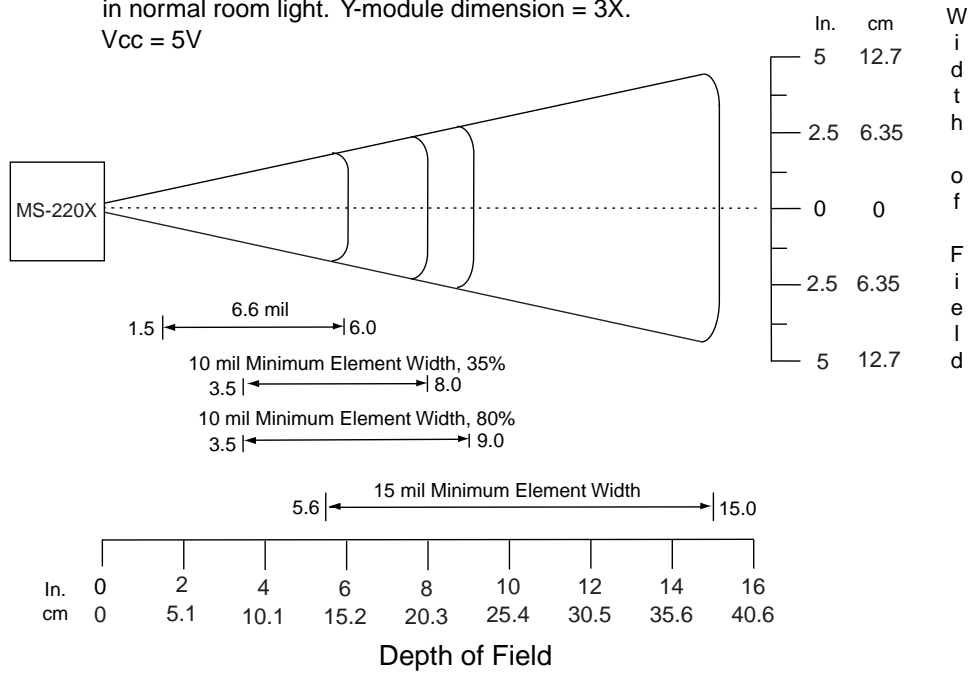

Figure 5-6 MS2204 2D Slab/Raster Decode Distances

✓ **NOTE** Not optimized for omnidirectional mode.

## MS2204 2D Decode Distances

**Table 5-4** MS2204 2D Slab/Raster Decode Distances

Symbol Density/ p/n / Bar Code Type	Bar Code Content/ Contrast <sup>1</sup>	Typical Working Ranges <sup>3</sup>		Guaranteed Working Ranges <sup>3</sup>	
		Near	Far	Near	Far
6.6 mil 64-14035-01 PDF417	ABCDEF 80% MRD	1.5 in. 3.81 cm	6.00 in. 15.24 cm	Note 2	4.75 in. 12.07 cm
10 mil 64-14937-01 PDF417	012345678905 35% MRD	3.5 in. 8.89 cm	8.0 in. 20.32 cm	Note 2	5.0 in. 12.7 cm
10 mil 64-14037-01 PDF417	80% MRD	3.5 in. 8.89 cm	9.0 in. 22.86 cm	Note 2	7.5 in. 19.05 cm
15 mil 64-14038-01 PDF417	80% MRD	5.6 in. 14.22 cm	15.0 in. 38.10 cm	Note 2	13.0 in. 33.02 cm

**Notes:**

1. Contrast measured as Mean Reflective Difference (MRD) at 650 nm.
2. Near ranges on lower densities largely depend on the width of the bar code and the scan angle.
3. Working range specifications: Photographic quality symbols, pitch = 10°, skew = 0°, roll = 0°, ambient light < 150 ft. candles, and temperature = 23 °C.



**NOTE** Not optimized for omnidirectional mode.

### Usable Scan Length

The decode zone is a function of various symbol characteristics including density, print contrast, wide-to-narrow ratio, and edge acuity. Consider the width of the decode zone at any given distance when designing a system.

*Calculating the Usable Scan Length Method on page 2-9* describes how to calculate the usable scan length.



# Chapter 6 MS2204VHD Specifications

---

## Introduction

This chapter provides the technical specifications for the MS2204VHD scanner.

---

## MS2204VHD Electrical Interface

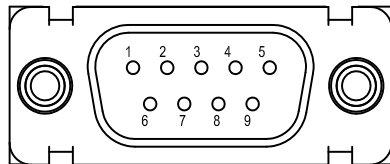

**Figure 6-1** *MiniScan Connector*

Table 6-1 lists the pin functions of the MS2204VHD.

**Table 6-1** MS2204VHD Electrical Interface

Pin No.	Pin Name	Type*	Function
1	Trigger	I	Signals scanner to begin scanning session.
2	TXD	O	Serial data transmit output. Drives the serial data receive input on the device communicating with the scanner.
3	RXD	I	Serial data receive input. Driven by the serial data transmit output on the device communicating with the scanner.
4	Not used		
5	Ground		Power supply ground input and signal ground reference.
6	Power	I	5.0 VDC $\pm$ 10%
7	CTS	I	Clear-to-send handshaking input line, used only in conjunction with the RTS line. Optionally used by another device to signal the scanner to begin transmitting data.
8	RTS	O	Request-to-send handshaking output line, used only in conjunction with the CTS line. Optionally used by the scanner to signal another device that data is available to send.
9	Beeper/Download	I/O	During normal operation this signal functions as an external beeper drive line. This signal can sink 50mA of current to drive an external beeper, and is normally pulled up. This signal is also used to begin Flash Download operation when grounded externally during power up.

**\*I = Input O = Output**



## MS2204VHD Mechanical Drawings

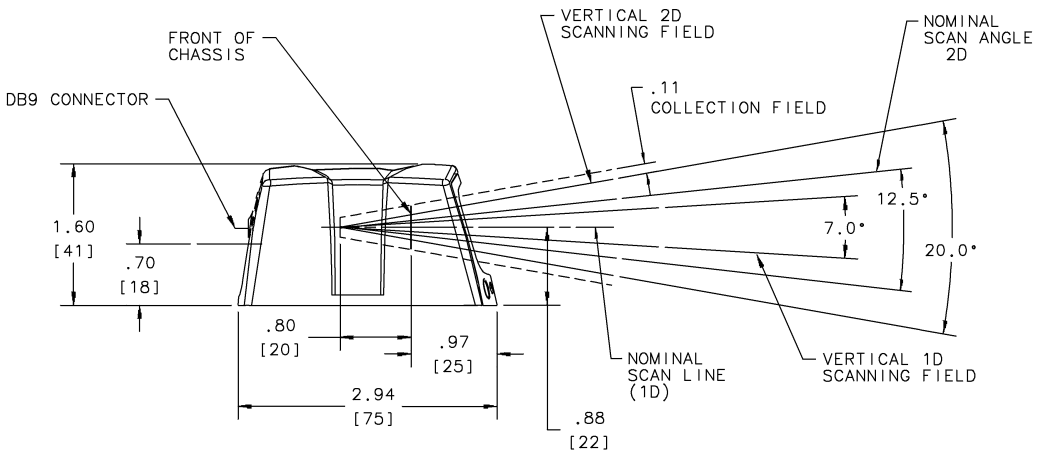

### Notes:

Unless otherwise specified:

- Dimensions are in inches, dimensions in [ ] are mm.
- User mounting tolerances are not included.

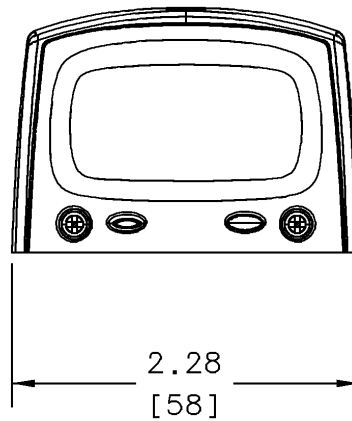

**Figure 6-2** MS2204VHD Mechanical Drawing

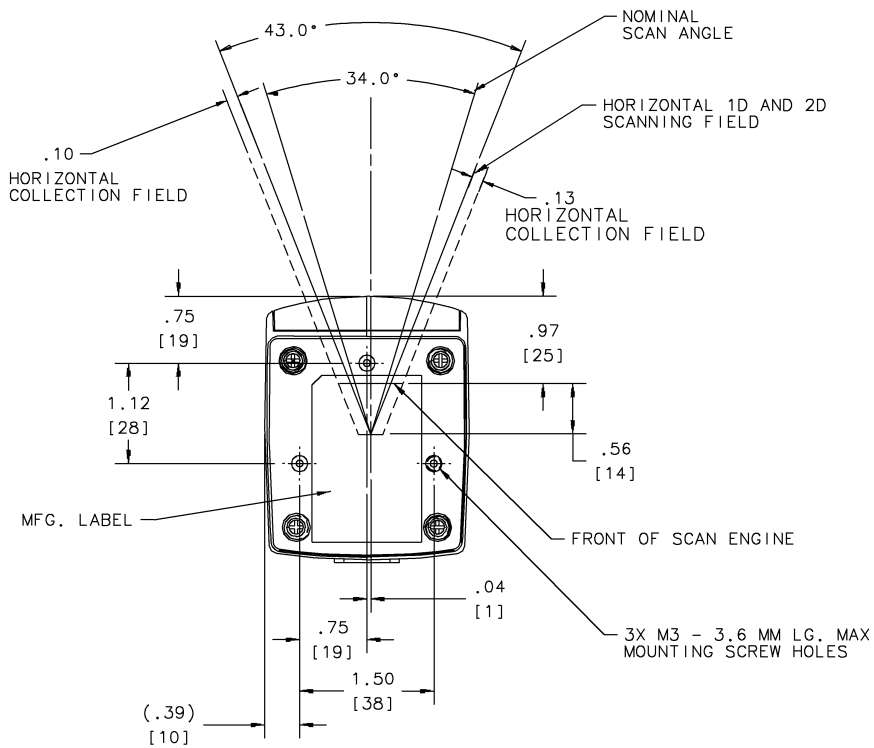

Notes:

Unless otherwise specified:

- Dimensions are in inches, dimensions in [ ] are mm.
- User mounting tolerances are not included.

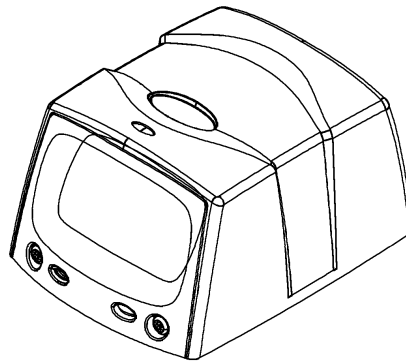

Figure 6-3 MS2204VHD Mechanical Drawing

## MS2204VHD Technical Specifications

[Table 6-2](#) provides the MS2204VHD technical specifications.

**Table 6-2** MS2204VHD Technical Specifications @ 23°C

Item	Description
Power Requirements	
Input Voltage	5.0 VDC $\pm$ 10%
Scanning Current	250 $\pm$ 30 mA typical
Standby Current	25 $\pm$ 5 mA typical
V <sub>cc</sub> Noise Level	200 mV peak-to-peak max.
Laser Power	0.7 mW $\pm$ 0.1 mW, $\lambda$ = 650 nm nominal
Scan Rate	640 scans/sec.
Scan Frequency: Horizontal	320 Hz $\pm$ 5 Hz
Scan Frequency: Vertical	282 Hz $\pm$ 5 Hz
Frame Rate	24 frames/sec. 12 Hz $\pm$ 1 Hz (vertical)
Print Contrast	Minimum 35% absolute dark/light reflectance differential
Scan Angle	Horizontal: 34° $\pm$ 3° Vertical: 12.5° $\pm$ 3°
Scan Pattern	Smart raster, high density single scan line
Start Time	0.065 sec. to 75% of steady state horizontal amplitude
Skew Tolerance	$\pm$ 15° from plane parallel to symbol (see <a href="#">Figure 6-4 on page 6-7</a> )
Pitch Angle	$\pm$ 30° from normal (see <a href="#">Figure 6-5 on page 6-8</a> )
Roll	$\pm$ 4° (for scanning benchmark label, assuming 3:1 codeword aspect ratio) (see <a href="#">Figure 6-4 on page 6-7</a> )
Decode Depth of Field	See <a href="#">Figure 6-5 on page 6-8</a> and <a href="#">Figure 6-6 on page 6-10</a>
Beam Deviation (offset from the nominal)	Horizontal: $\pm$ 3.0° Vertical: $\pm$ 3.0° Horizontal tilt: $\pm$ 2°
Additional Post Shock Beam Deviation (2000G Shock)	Horizontal: $\pm$ 3.0° max Vertical: $\pm$ 6.0° max
Ambient Light Immunity	
Sunlight	8,000 ft. candles (86,112 lux)
Artificial Light	450 ft. candles (4,844 lux)
Drop	Multiple 30" drops

**Table 6-2** MS2204VHD Technical Specifications @ 23°C (Continued)

Item	Description
Vibration	Unpowered scanner withstands a random vibration along each of the X, Y and Z axes for a period of one hour per axis, defined as follows: 20 to 80 Hz      Ramp up to 0.04 G <sup>2</sup> /Hz at the rate of 3dB/octave. 80 to 350 Hz      0.04 G <sup>2</sup> /Hz 350 to 2000 Hz   Ramp down at the rate of 3 dB/octave.
ESD	± 20kV air discharge ± 8kV indirect discharge
Sealing	IP54
Operating Temperature	-22° to 122°F (-30° to 50°C)
Storage Temperature	-40° to 158°F (-40° to 70°C)
Humidity	5% to 95% non-condensing
Laser Class	CDRH Class II, IEC Class 2
Height	1.60 in. (4.06 cm)
Width	2.28 in. (5.79 cm)
Depth	2.94 in. (7.47 cm)
Weight	4.73 oz. (134 gm)

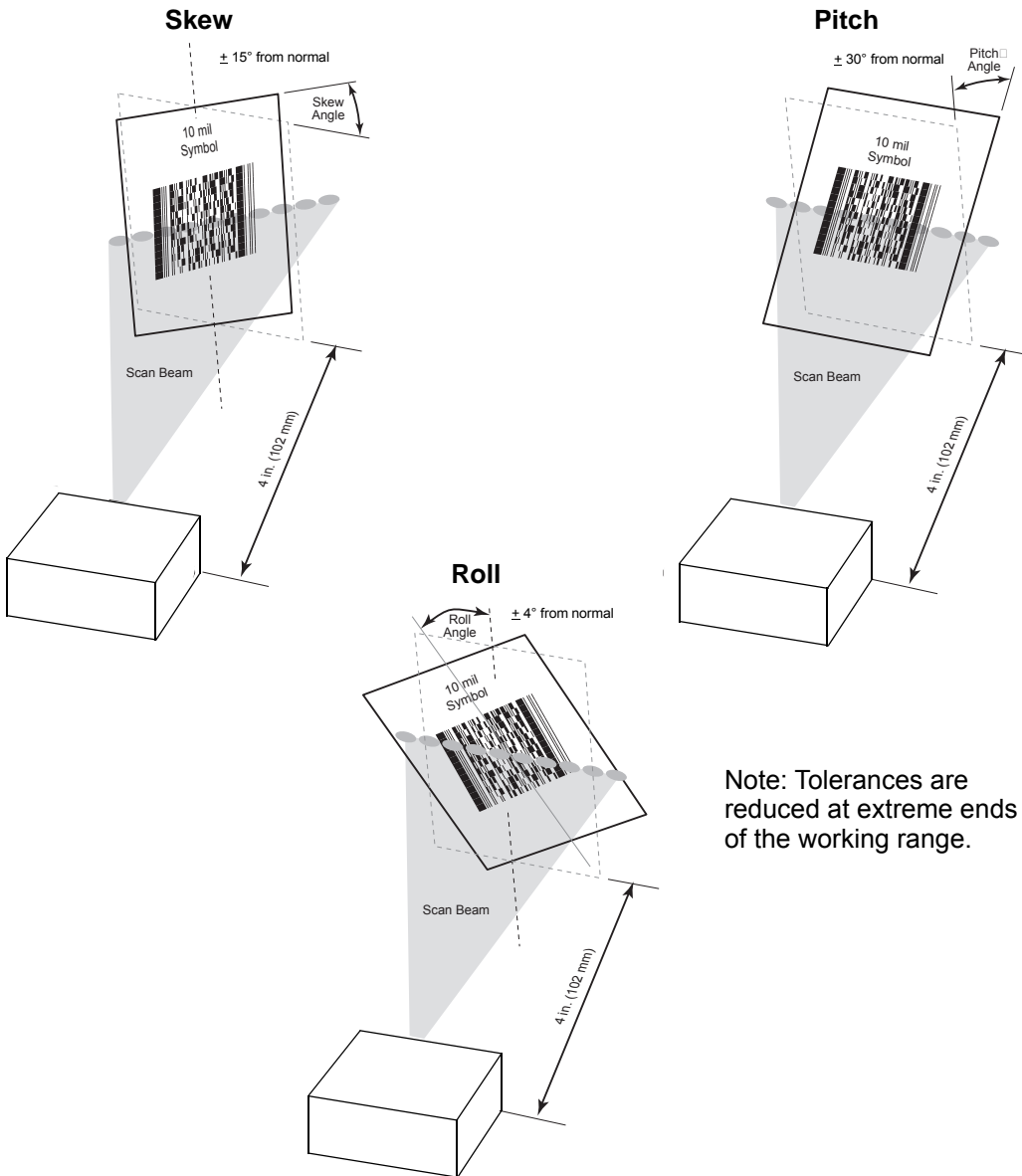

Figure 6-4 Skew, Pitch and Roll

## MS2204VHD Decode Zones

The decode zone is a function of various symbol characteristics including density, print contrast, wide to narrow ratio, and edge acuity. Typical values appear. [Table 6-3 on page 6-9](#) and [Table 6-4 on page 6-11](#) list the typical and guaranteed distances for selected bar code densities. The minimum element width (or “symbol density”) is the width in mils of the narrowest element (bar or space) in the symbol. The maximum usable length of a symbol at any given range appears below. To calculate this distance, see [Calculating the Usable Scan Length Method on page 2-9](#).

### MS2204VHD 1D Decode Zone

Note: Typical performance at 68°F (20°C)  
on high quality symbols in normal room light.  
Vcc = 5V

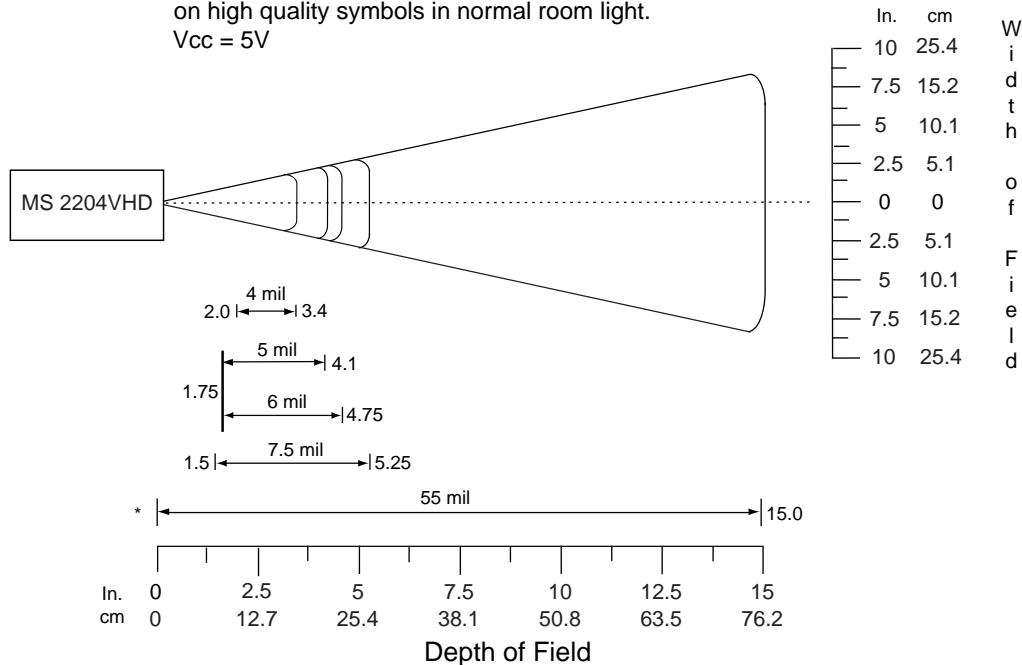

\* Minimum distance determined by symbol length and scan angle.

Figure 6-5 MS2204VHD 1D Slab/Raster Decode Distances

## MS2204VHD 1D Decode Distances

**Table 6-3** MS2204VHD 1D Decode Distances

Symbol Density/ p/n / Bar Code Type	Bar Code Content/ Contrast <sup>1</sup>	Typical Working Ranges <sup>3</sup>		Guaranteed Working Ranges <sup>3</sup>	
		Near	Far	Near	Far
4 mil 64-15660-01 Code 39	STI4026 80% MRD	2.0 in. 5.08 cm	3.4 in. 8.64 cm	2.75 in. 7.00 cm	2.8 in. 7.11 cm
5 mil 64-18779-01 Code 39	STI5025 80% MRD	1.75 in. 4.45 cm	4.1 in. 10.41 cm	2.25 in. 5.72 cm	3.5 in. 8.89 cm
6 mil 64-01755-01 Code 39	123 80% MRD	1.75 in. 4.45 cm	4.75 in. 12.07 cm	2.25 in. 5.72 cm	4.0 in. 10.16 cm
7.5 mil 63-04191-01 Code 39	STI30F4 80% MRD	1.50 in. 3.81 cm	5.25 in. 13.34 cm	2.00 in. 5.08 cm	4.75 in. 12.07 cm
55 mil 60-01601-01 Code 39	A 80% MRD	Note 2	15.0 in. 38.10 cm	Note 2	12.5 in. 31.75 cm

**Notes:**

**1. Contrast measured as Mean Reflective Difference (MRD) at 650 nm.**

**2. Near ranges on lower densities largely depend on the width of the bar code and the scan angle.**

**3. Working range specifications: Photographic quality symbols, pitch = 10°, skew = 0°, roll = 0°, ambient light < 150 ft. candles, and temperature = 23 °C.**

### MS2204VHD 2D Decode Zone

Note: Typical performance at 68°F (20°C) on high quality symbols in normal room light. Y-module dimension = 3X.  
Vcc = 5V

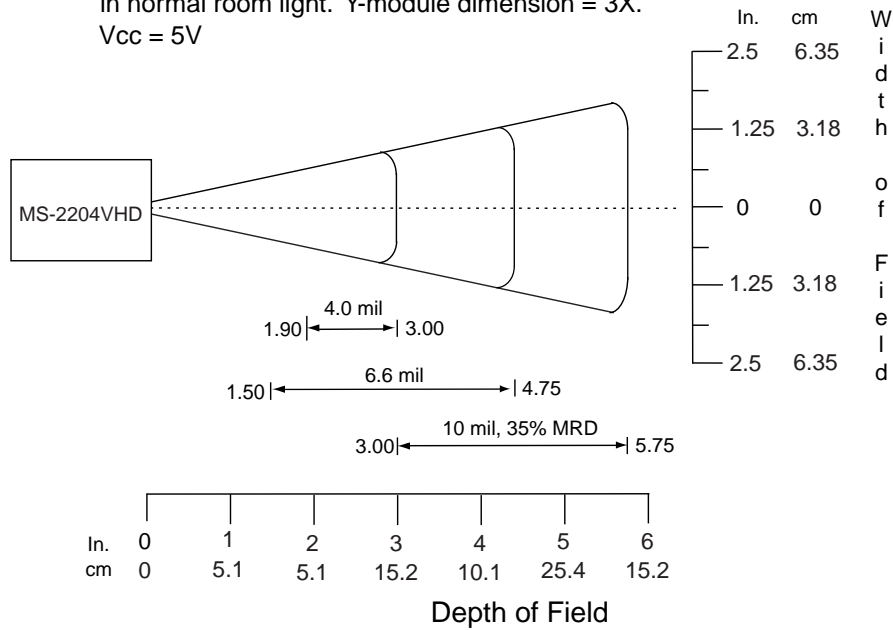

Figure 6-6 MS2204VHD 2D Slab/Raster Decode Distances

✓ **NOTE** Not optimized for omnidirectional mode.



## MS2204VHD 2D Decode Distances

**Table 6-4** MS2204VHD 2D Slab/Raster Decode Distances

Symbol Density/ p/n / Bar Code Type	Bar Code Content/ Contrast <sup>1</sup>	Typical Working Ranges <sup>3</sup>		Guaranteed Working Ranges <sup>3</sup>	
		Near	Far	Near	Far
4 mil 64-17025-01 PDF417	123 80% MRD	1.90 in. 4.83 cm	3.00 in. 7.62 cm	2.20 in. 5.59 cm	2.70 in. 6.89 cm
6.6 mil 64-14035-01 PDF417	ABCDEF 80% MRD	1.50 in. 3.81 cm	4.75 in. 12.07 cm	2.00 in. 5.08 cm	4.50 in. 11.43 cm
10 mil 64-14937-01 PDF417	012345678905 80% MRD	3.00 in. 7.62 cm	5.75 in. 14.61 cm	4.25 in. 10.80 cm	5.00 in. 12.72 cm

**Notes:**

1. Contrast measured as Mean Reflective Difference (MRD) at 650 nm.
2. Near ranges on lower densities largely depend on the width of the bar code and the scan angle.
3. Working range specifications: Photographic quality symbols, pitch = 10°, skew = 0°, roll = 0°, ambient light < 150 ft. candles, and temperature = 23 °C.

✓ **NOTE** Not optimized for omnidirectional mode.

## Usable Scan Length

The decode zone is a function of various symbol characteristics including density, print contrast, wide-to-narrow ratio, and edge acuity. Consider the width of the decode zone at any given distance when designing a system.

*Calculating the Usable Scan Length Method on page 2-9* describes how to calculate the usable scan length. The *Usable Scan Length Diagram on page 2-10* provides the scan angle.



# Chapter 7 MS3204 Specifications

---

## Introduction

This chapter provides the technical specifications for the MS3204 scanner.

## MS3204 Electrical Interface

This section describes the pin functions of the MS3204 scanner.

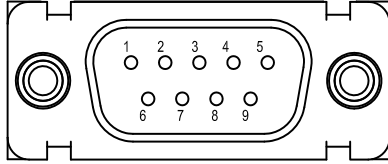

**Figure 7-1** MS3204 Connector

**Table 7-1** MS3204 Electrical Interface

Pin No.	Pin Name	Type*	Function
1	Trigger	I	Signals scanner to begin scanning session.
2	TXD	O	Serial data transmit output. Drives the serial data receive input on the device communicating with the scanner.
3	RXD	I	Serial data receive input. Driven by the serial data transmit output on the device communicating with the scanner.
4	Not used		
5	Ground		Power supply ground input and signal ground reference.
6	Power	I	5.0 VDC $\pm$ 10%
7	CTS	I	Clear-to-send handshaking input line, used only in conjunction with the RTS line. Optionally used by another device to signal the scanner to begin transmitting data.
8	RTS	O	Request-to-send handshaking output line, used only in conjunction with the CTS line. Optionally used by the scanner to signal another device that data is available to send.
9	Beeper/Download	I/O	During normal operation this signal functions as an external beeper drive line. This signal can sink 50mA of current to drive an external beeper, and is normally pulled up. This signal is also used to begin Flash Download operation when grounded externally during power up.

\*I = Input O = Output

## MS3204 Mechanical Drawings

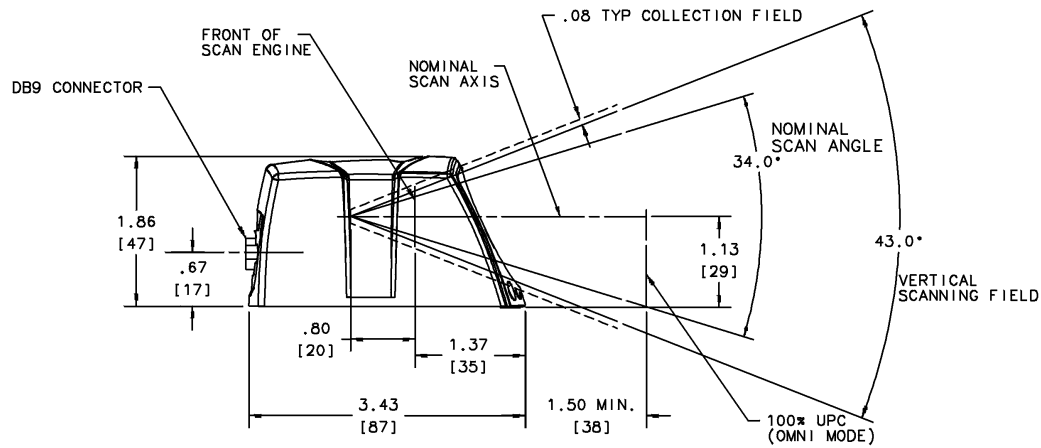

### Notes:

Unless otherwise specified:

- Dimensions are in inches, dimensions in [ ] are mm.
- User mounting tolerances are not included.

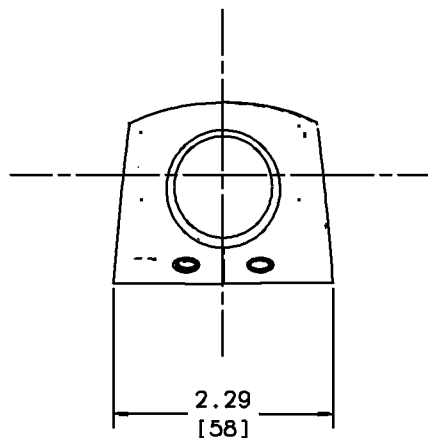

**Figure 7-2** MS3204 Mechanical Drawing

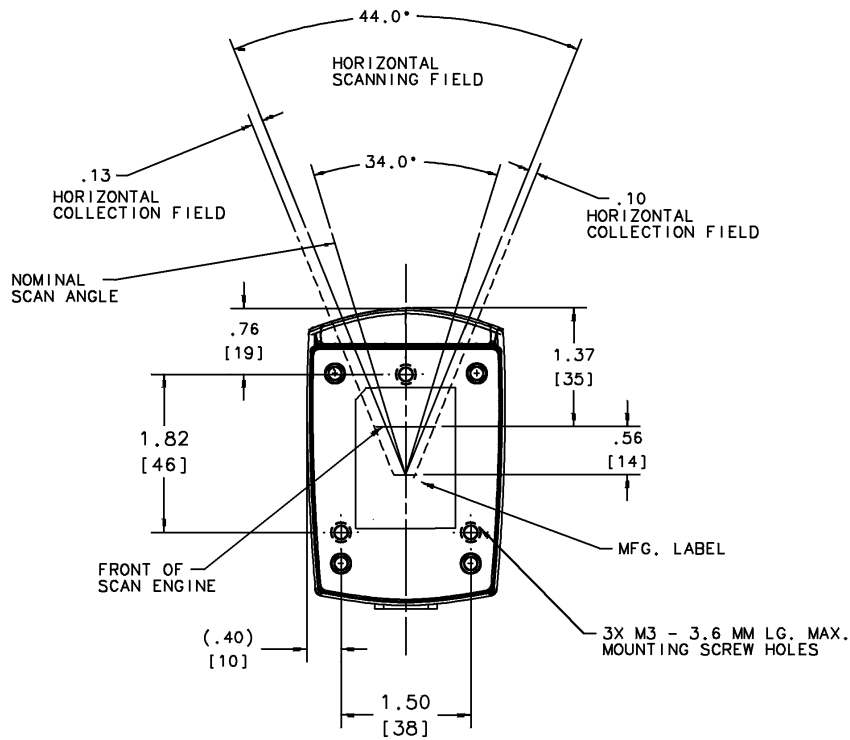

Notes:

Unless otherwise specified:

- Dimensions are in inches, dimensions in [ ] are mm.
- User mounting tolerances are not included.

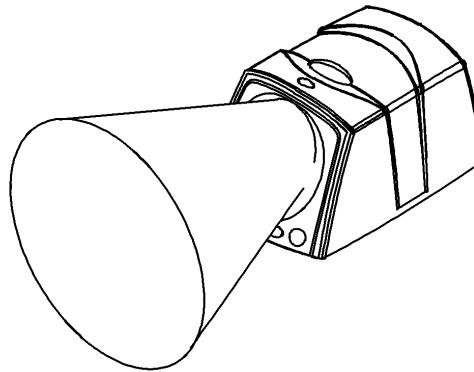

Figure 7-3 MS3204 Mechanical Drawing

## MS3204 Technical Specifications

**Table 7-2** MS3204 Technical Specifications @ 23°C

Item	Description
Power Requirements	
Input Voltage	+5.0 VDC $\pm$ 10%
Scanning Current	250 $\pm$ 30 mA typical
Standby Current	21 $\pm$ 5 mA typical
V <sub>cc</sub> Noise Level	200 mV peak-to-peak max.
Laser Power	0.7 mW typical, 0.8 mW maximum, $\lambda$ = 650 nm
Scan Rate	640 scans/second
Scan Frequency: Horizontal	320 Hz $\pm$ 5 Hz
Scan Frequency: Vertical	282 Hz $\pm$ 5 Hz
Frame Rate	24 frames/sec. 12 Hz $\pm$ 1 Hz (vertical)
Print Contrast	Minimum 35% absolute dark/light reflectance differential (PDF); 35% absolute dark/light reflectance differential (1D)
Scan Angle	Horizontal: 34° $\pm$ 1.5° Vertical: 12.5° $\pm$ 1.5°
Scan Pattern	<b>MS3204-I000</b> : Omnidirectional, semi-omnidirectional, smart raster, high density single scan line <b>MS3204-E000</b> : Omnidirectional only
Start Time	0.065 sec. to 75% of steady state horizontal amplitude
Skew Tolerance	$\pm$ 15° from normal (see <a href="#">Figure 7-4 on page 7-7</a> )
Pitch Angle	$\pm$ 30° from normal (see <a href="#">Figure 7-4 on page 7-7</a> )
Roll	$\pm$ 4° from vertical (see <a href="#">Figure 7-4 on page 7-7</a> ) (For scanning benchmark label, assuming 3:1 codeword aspect ratio). Note that this is dependent on the decoder.
Decode Depth of Field	See <a href="#">Figure 7-5 on page 7-8</a> and <a href="#">Figure 7-6 on page 7-10</a>
Beam Deviation (offset from the nominal)	Horizontal: $\pm$ 3.0° Vertical: $\pm$ 3.0° Horizontal tilt: $\pm$ 2°
Additional Post Shock Beam Deviation (2000G Shock)	Horizontal: $\pm$ 3.0° max Vertical: $\pm$ 6.0° max

**Table 7-2** MS3204 Technical Specifications @ 23°C (Continued)

Item	Description
Ambient Light Immunity Sunlight Artificial Light	8,000 ft. candles (86,112 lux) 450 ft. candles (4,844 lux)
Drop	Multiple 30 inch drops
Vibration	Unpowered scanner withstands a random vibration along each of the X, Y and Z axes for a period of one hour per axis, defined as follows: 20 to 80 Hz Ramp up to 0.04 G <sup>2</sup> /Hz at the rate of 3dB/octave. 80 to 350 Hz 0.04 G <sup>2</sup> /Hz 350 to 2000 Hz Ramp down at the rate of 3 dB/octave.
ESD	± 20kV air discharge ± 8kV indirect discharge
Sealing	IP54
Operating Temperature	-22 °F to 122 °F (-30 °C to 50 °C)
Storage Temperature	-40 °F to 158 °F (-40 °C to 70 °C)
Humidity	5% to 95% non-condensing
Laser Class	CDRH Class II, IEC Class 2
Height	1.98 in. (5.03 cm)
Width	2.41 in. (6.12 cm)
Depth	3.60 in. (9.14 cm)
Weight	4.97 oz. (141 g)



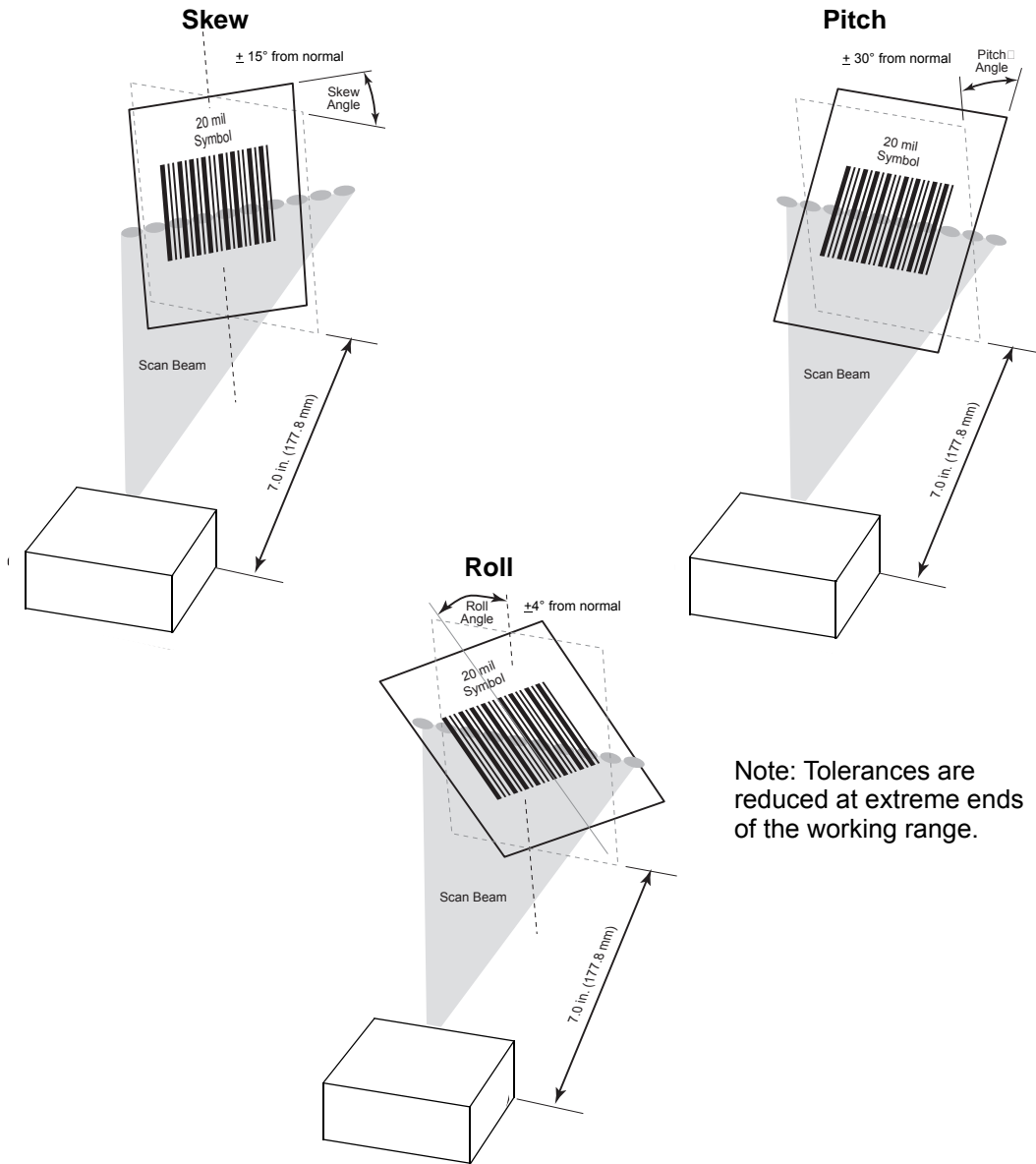

Figure 7-4 Skew, Pitch and Roll

## MS3204 Decode Zones

The decode zone is a function of various symbol characteristics including density, print contrast, wide to narrow ratio, and edge acuity. These figures are typical values. [Table 7-3 on page 7-9](#) and [Table 7-4 on page 7-11](#) list the typical and guaranteed distances for selected bar code densities. The minimum element width (or “symbol density”) is the width in mils of the narrowest element (bar or space) in the symbol. The maximum usable length of a symbol at any given range appears below. To calculate this distance, see [Calculating the Usable Scan Length Method on page 2-9](#).

### Omnidirectional Decode Distances

Note: Typical performance at 68°F (20°C)  
on high quality symbols in normal room light.  
Vcc = 5V

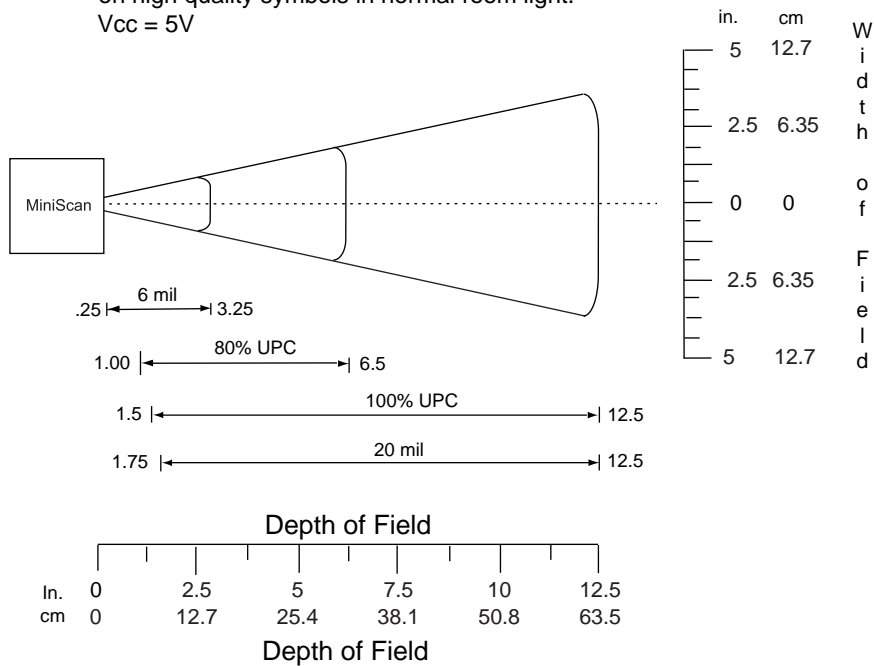

\* Minimum distance determined by symbol length and scan angle.

Figure 7-5 MS3204 Omnidirectional Decode Zone

**Table 7-3** MS3204 Omnidirectional Decode Distances

Symbol Density/ p/n / Bar Code Type	Bar Code Content/ Contrast <sup>1</sup>	Typical Working Ranges <sup>3</sup>		Guaranteed Working Ranges <sup>3</sup>	
		Near	Far	Near	Far
6.0 mil 60-01755-01 Code 39	123 80% MRD	0.25 in. 0.64 cm	3.25 in. 8.3 cm	0.75 in. 1.9 cm	2.25 in. 5.7 cm
64-06629-01 80% UPC	0080015 80% MRD	1.0 in. 2.5 cm	6.5 in. 16.5 cm	1.5 in. 3.8 cm	4.5 in. 11.4 cm
13 mil 64-05303-01 100% UPC	012345678905 80% MRD	1.5 in. 3.8 cm	12.5 in. 31.2 cm	Note 2	9.5 in. 24.1 cm
20 mil 1D 60-02710-03 LC 35%	123 80% MRD	1.75 in. 4.4 cm	12.5 in. 31.8 cm	Note 2	10.0 in. 25.4 cm

**Notes:**

**1. Contrast measured as Mean Reflective Difference (MRD) at 650 nm.**

**2. Near ranges on largely depend on the width of the bar code and the scan angle.**

**3. Working range specifications: Photographic quality symbols, pitch = 15°, skew = 0°, roll = 0°, ambient light < 150 ft. candles, and temperature = 23 °C, Vcc = 5V.**

**4. Measured from the front of the scanner.**

### 2D Slab/Raster Decode Distances (MS3204-I000 Only)

Note: Typical performance at 68°F (20°C)  
on high quality symbols in normal room light.  
Vcc = 5V

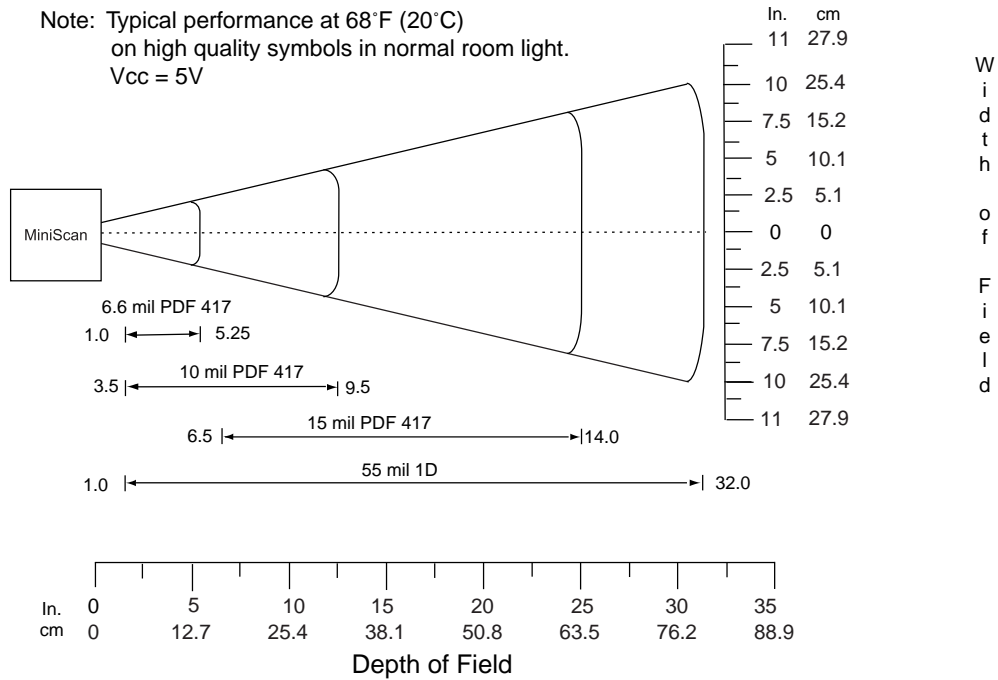

\* Minimum distance determined by symbol length and scan angle.

Figure 7-6 MS3204 2D Slab/Raster Decode Distance

**Table 7-4** MS3204-I000 2D Slab/Raster Decode Distances

Symbol Density/ p/n / Bar Code Type	Bar Code Content/ Contrast <sup>1</sup>	Typical Working Ranges <sup>3</sup>		Guaranteed Working Ranges <sup>3</sup>	
		Near	Far	Near	Far
6.6 mil 64-14035-01 2D	123 80% MRD	1.0 in. 2.54 cm	5.25 in. 13.34 cm	1.5 in. 3.8 cm	3.75 in. 9.5 cm
10 mil 64-14037-01 2D	ABCDEF 80% MRD	3.5 in. 8.89 cm	9.5 in. 24.13 cm	5.0 in. 12.7 cm	7.5 in. 9.5 cm
15 mil 64-14038-01 2D	012345678905 80% MRD	6.5 in. 16.51 cm	14.0 in. 35.6 cm	Note 2	11.0 in. 24.1 cm
55 mil 64-17458-01 1D	CD 80% MRD	1.0 in. 2.54 cm	32 in. 81.3 cm	Note 2	22.0 in. 55.9 cm

**Notes:**

**1. Contrast measured as Mean Reflective Difference (MRD) at 650 nm.**

**2. Near ranges on largely depend on the width of the bar code and the scan angle.**

**3. Working range specifications: Photographic quality symbols, pitch = 15°, skew = 0°, roll = 0°, ambient light < 150 ft. candles, and temperature = 23 °C, Vcc = 5V.**

**4. Measured from the front of the scanner.**

## Usable Scan Length

The decode zone is a function of various symbol characteristics including density, print contrast, wide-to-narrow ratio, and edge acuity. Consider the width of the decode zone at any given distance when designing a system.

*Calculating the Usable Scan Length Method on page 2-9* describes how to calculate the usable scan length. *Table 7-2 on page 7-5* provides the scan angle.



# Chapter 8 MS954 Specifications

---

## Introduction

This chapter provides the technical specifications for the MS954 scanner.

## MS954 Electrical Interface

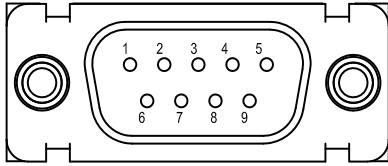

**Figure 8-1** MiniScan Connector

[Table 8-1](#) lists the pin functions of the MS954 interface.

**Table 8-1** MS954 Electrical Interface

Pin No.	Pin Name	Type*	Function
1	Trigger	I	Signals scanner to begin scanning session.
2	TXD	O	Serial data transmit output. Drives the serial data receive input on the device communicating with the scanner.
3	RXD	I	Serial data receive input. Driven by the serial data transmit output on the device communicating with the scanner.
4	Not used		
5	Ground		Power supply ground input and signal ground reference.
6	Power	I	5.0 VDC $\pm$ 10%
7	CTS	I	Clear-to-send handshaking input line, used only in conjunction with the RTS line. Optionally used by another device to signal the scanner to begin transmitting data.
8	RTS	O	Request-to-send handshaking output line, used only in conjunction with the CTS line. Optionally used by the scanner to signal another device that data is available to send.
9	Beeper/Download	I/O	During normal operation this signal functions as an external beeper drive line. This signal can sink 50 mA of current to drive an external beeper, and is normally pulled up. This signal is also used to begin Flash Download operation when grounded externally during power up.

**\*I = Input O = Output**



## MS954 Mechanical Drawings

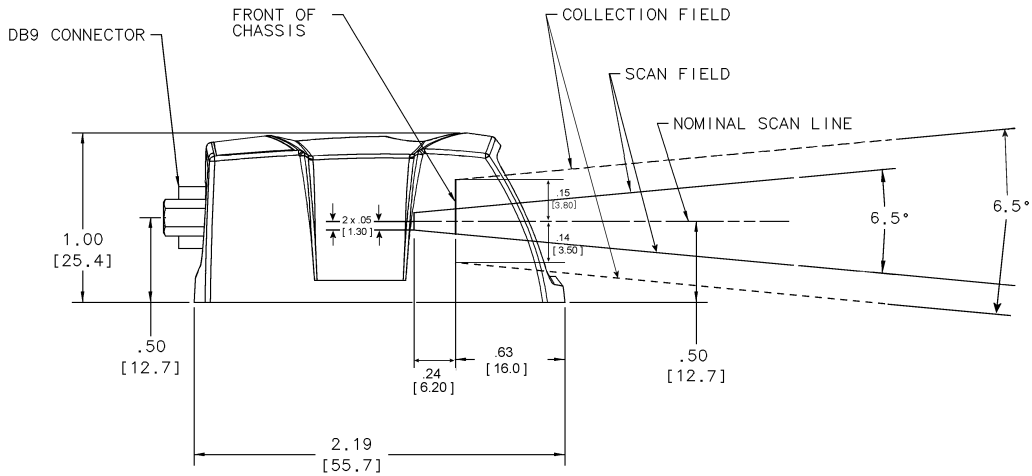

### Notes:

Unless otherwise specified:

- Dimensions are in inches, dimensions in [ ] are mm.
- User mounting tolerances are not included.

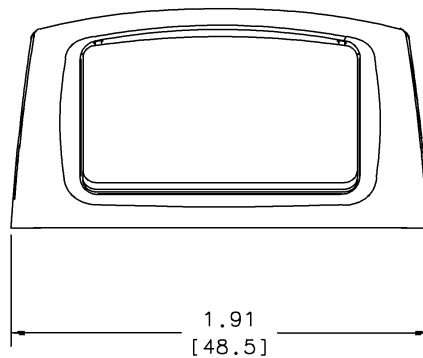

**Figure 8-2** MS954 Mechanical Drawing

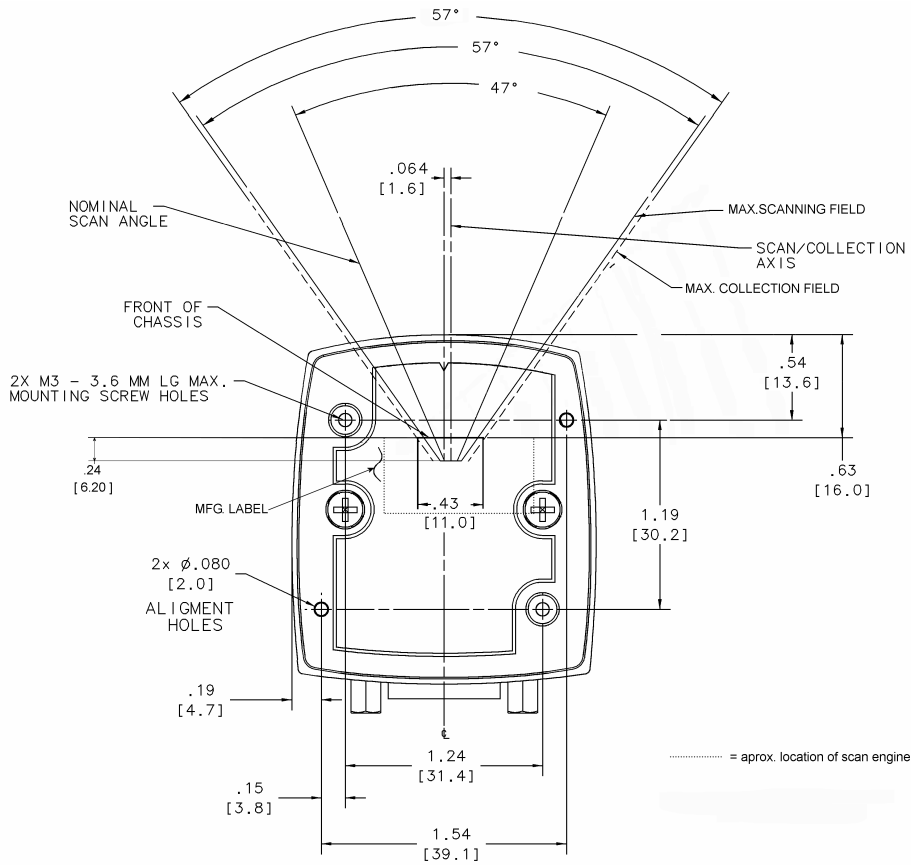

**Notes:**

Unless otherwise specified:

- Dimensions are in inches, dimensions in [ ] are mm.
- User mounting tolerances are not included.

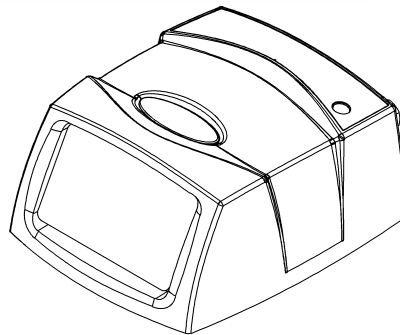

**Figure 8-3** MS954 Mechanical Drawing

## MS954 Technical Specifications

**Table 8-2** MS954 Technical Specifications @ 23°C

Item	Description
Power Requirements	
Input Voltage	5.0 VDC $\pm$ 10%
Scanning Current	105 mA typical; 130 mA max
Standby Current	27 mA typical; 60 mA max
V <sub>cc</sub> Noise Level	200 mV peak-to-peak max.
Laser Power	1.9 mW typical, $\lambda$ = 655 nm nominal
Scan Rate	104 ( $\pm$ 12) scans/sec (bidirectional)
Print Contrast	Minimum 25% absolute dark/light reflectance measured at 650 nm.
Scan Angle	Default (Wide): $47^\circ \pm 3^\circ$ Alternate (Narrow): $35^\circ \pm 3^\circ$ Note: The MS954 does not require margin on either side of the bar code to decode. The $47^\circ$ scan line provides identical scanning performance to older MiniScans (e.g., MS923) with a scan line of $53^\circ$ .
Scan Pattern	Single scan line
Skew Tolerance	$\pm 40^\circ$ from normal (see <a href="#">Figure 8-4 on page 8-6</a> )
Pitch Angle	$\pm 65^\circ$ from normal (see <a href="#">Figure 8-4 on page 8-6</a> )
Roll	$\pm 35^\circ$ from vertical (see <a href="#">Figure 8-4 on page 8-6</a> )
Decode Depth of Field	See <a href="#">Figure 8-5 on page 8-7</a> and <a href="#">Figure 8-6 on page 8-9</a>
Ambient Light Immunity	
Sunlight	10,000 ft. candles (107,640 lux)
Artificial Light	450 ft. candles (4,844 lux)
Drop	Multiple 30" drops
Vibration	Unpowered engine withstands a random vibration along each of the X, Y, and Z axes for a period of 1 hour per axis, defined as follows: 20 - 80 Hz: ramp up to $0.04G^2/Hz$ at the rate of 3dB/octave. 80 - 350 Hz: $00.04 G^2/Hz$ . 350 - 2000 Hz: ramp down at the rate of 3dB/octave.
ESD	$\pm 15kV$ air discharge $\pm 8kV$ indirect discharge
Operating Temperature	$-4^\circ F$ to $140^\circ F$ ( $-20^\circ C$ to $60^\circ C$ )
Storage Temperature	$-40^\circ F$ to $158^\circ F$ ( $-40^\circ C$ to $70^\circ C$ )
Humidity	95% (non-condensing)

**Table 8-2** MS954 Technical Specifications @ 23°C (Continued)

Item	Description
Laser Class	CDRH Class II, IEC Class 2
Height	1.02 in. (2.59 cm) maximum
Width	1.93 in. (4.90 cm) maximum
Depth	2.31 in. (5.87 cm) maximum
Weight	1.67 oz. (47.34 g)

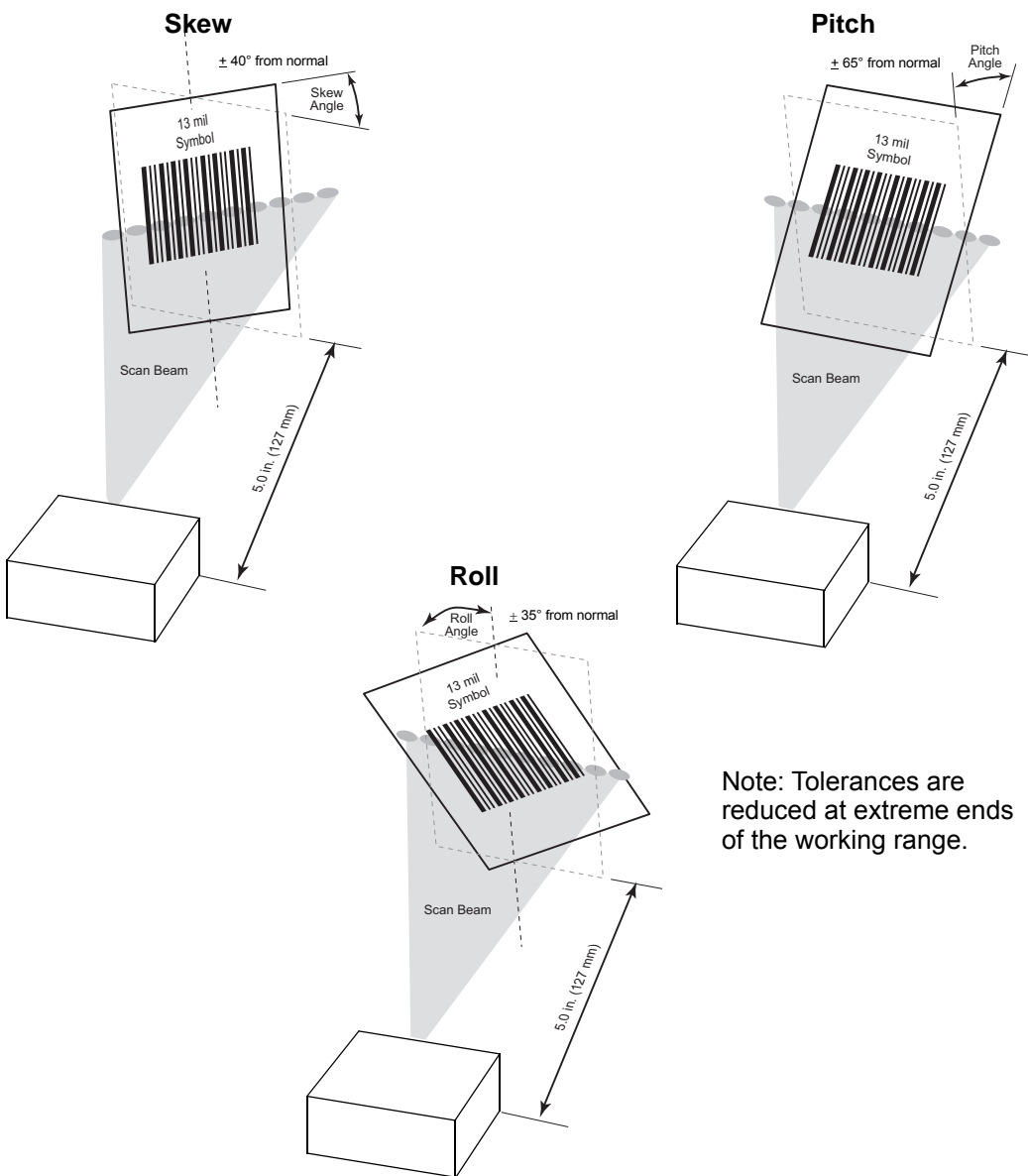
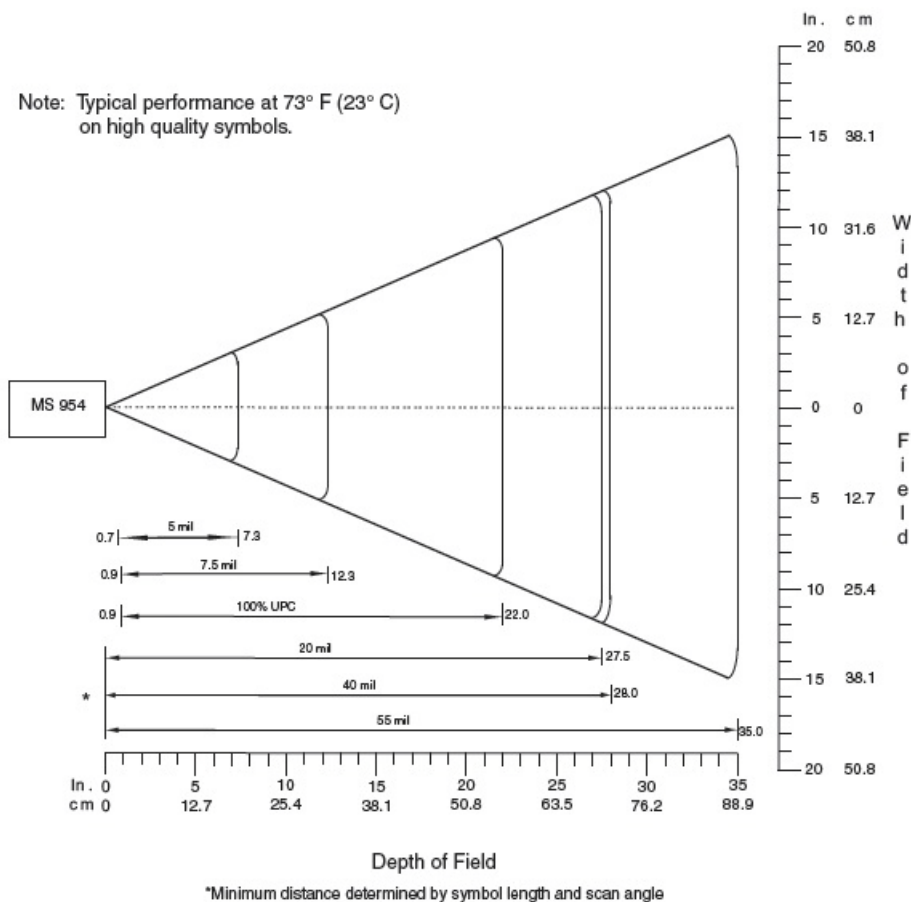

**Figure 8-4** Skew, Pitch and Roll

## MS954 Decode Zone

*Figure 8-5* (prior to July 1, 2014 manufacture date) and *Figure 8-6* (after July 1, 2014 manufacture date) shows the decode zones for the MS954 scanner. These figures are typical values. *Table 8-3* (prior to July 1, 2014 manufacture date) and *Table 8-4* (after July 1, 2014 manufacture date) lists the typical and guaranteed distances for selected bar code densities. The minimum element width (or “symbol density”) is the width in mils of the narrowest element (bar or space) in the symbol. To calculate this distance, see *Calculating the Usable Scan Length Method on page 2-9*.

### MS954 Decode Zone Prior to July 1, 2014 Manufacture Date.



**Figure 8-5** MS954 Decode Zone - Prior to July 1, 2014 Manufacture Date

**Table 8-3** MS954 Decode Distances - Prior to July 1, 2014 Manufacture Date

Symbol Density/ p/n / Bar Code Type/ W-N Ratio	Bar Code Content/ Contrast <sup>1</sup>	Typical Working Ranges		Guaranteed Working Ranges	
		Near	Far	Near	Far
5 mil 64-17453-01 Code 39; 2.5:1	ABCDEFGH 90% MRD	0.7 in. 1.8 cm	7.3 in. 18.54 cm	1.6 in. 4.06 cm	4.8 in. 12.19 cm
7.5 mil 64-17452-01 Code 39; 2.5:1	ABCDEF 90% MRD	0.9 in. 2.3 cm	12.4 in. 31.24 cm	1.4 in. 3.56 cm	8.8 in. 22.35 cm
13 mil 64-05303-01 100% UPC	12345678905 90% MRD	0.9 in. 2.3 cm	22.0 in. 55.88 cm	1.1 in. 2.79 cm	15.7 in. 39.88 cm
20 mil 60-01429-01 Code 39; 2.2:1	123 90% MRD	Note 2	27.5 in. 69.85 cm	Note 2	22.0 in. 55.88 cm
40 mil 64-17457-01 Code 39; 2.2:1	AB 90% MRD	Note 2	28.0 in. 71.12 cm	Note 2	23.0 in. 58.42 cm
55 mil 64-17458-01 Code 39; 2.2:1	CD 90% MRD	Note 2	35.0 in. 88.90 cm	Note 2	29.0 in. 73.66 cm

**Notes:**

**1. Contrast measured as Mean Reflective Difference (MRD) at 650 nm.**

**2. Near ranges on lower densities (not specified) largely depend on the width of the bar code and the scan angle.**

**3. Working range specifications at ambient temperature (23°C), pitch=15°, roll=0°, skew=0°, photographic quality, ambient light<200 ft-c.**

**MS954 Decode Zone After July 1, 2014 Manufacture Date**

Note: Typical performance at 73° F (23° C)  
on high quality symbols.

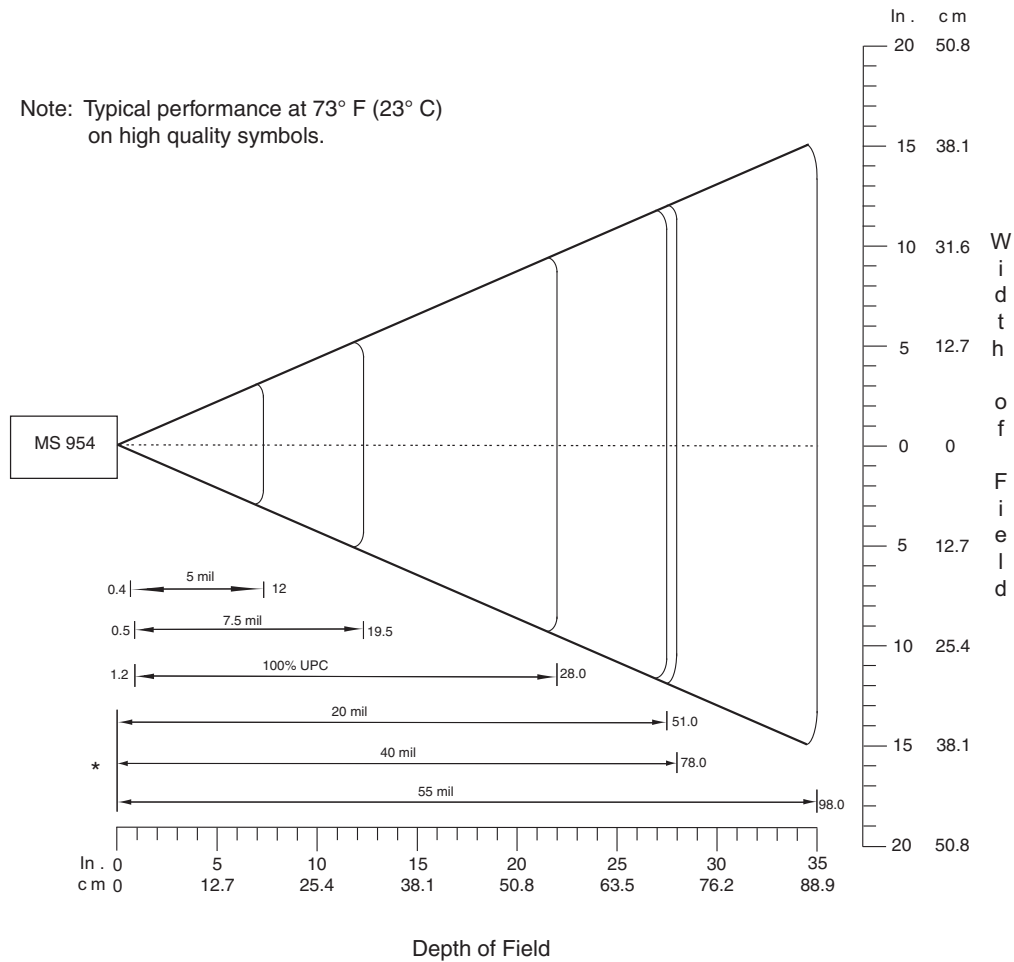

\*Minimum distance determined by symbol length and scan angle

**Figure 8-6** MS954 Decode Zone - After July 1, 2014 Manufacture Date

**Table 8-4** MS954 Decode Distances - After July 1, 2014 Manufacture Date

Symbol Density/ p/n / Bar Code Type/ W-N Ratio	Bar Code Content/ Contrast <sup>1</sup>	Typical Working Ranges		Guaranteed Working Ranges	
		Near	Far	Near	Far
5 mil 64-17453-01 Code 39; 2.5:1	ABCDEFGH 90% MRD	0.4 in. 1.0 cm	12.0 in. 30.5 cm	1.0 in. 2.54 cm	9.0 in. 22.86 cm
7.5 mil 64-17452-01 Code 39; 2.5:1	ABCDEF 90% MRD	0.5 in. 1.3 cm	19.5 in. 49.5 cm	1.0 in. 2.54 cm	15.0 in. 38.1 cm
13 mil 64-05303-01 100% UPC	12345678905 90% MRD	1.1 in. 3.0 cm	28.0 in. 71.1 cm	1.5 in. 3.81 cm	20.0 in. 50.8 cm
20 mil 60-01429-01 Code 39; 2.2:1	123 90% MRD	Note 2	51.0 in. 129.54 cm	Note 2	45.0 in. 114.3 cm
40 mil 64-17457-01 Code 39; 2.2:1	AB 90% MRD	Note 2	78.0 in. 198.12 cm	Note 2	50.0 in. 127.0 cm
55 mil 64-17458-01 Code 39; 2.2:1	CD 90% MRD	Note 2	98.0 in. 248.92 cm	Note 2	75.0 in. 190.5 cm

**Notes:**

**1. Contrast measured as Mean Reflective Difference (MRD) at 650 nm.**

**2. Near ranges on lower densities (not specified) largely depend on the width of the bar code and the scan angle.**

**3. Working range specifications at ambient temperature (23°C), pitch=15°, roll=0°, skew=0°, photographic quality, ambient light<200 ft-c.**

## Usable Scan Length

The decode zone is a function of various symbol characteristics including density, print contrast, wide-to-narrow ratio, and edge acuity. Consider the width of the scan line at any given distance when designing a system.

*Calculating the Usable Scan Length Method (MS954 Only) on page 2-10* describes how to calculate the usable scan length. The usable scan length diagram on *page 2-10* provides the scan angle.



# Chapter 9 Maintenance and Troubleshooting

---

## Introduction

The chapter provides information on maintenance and troubleshooting.

---

## Maintenance

Cleaning the exit window is the only maintenance required. Do not allow any abrasive material to touch the window. Clean the scan window with a damp cloth and, if necessary, a non-ammonia based detergent.

## Troubleshooting

**Table 9-1** *Troubleshooting*

Problem	Possible Cause	Possible Solutions
No red LED or nothing happens during a scan attempt.	No power to the scanner.	Check the system power. Confirm that the correct host interface cable is used.
		Connect the power supply.
		Re-connect loose cables.
Scanner cannot read the bar code.	Interface/power cables are loose.	Re-connect loose cables.
	Scanner is not programmed for the correct bar code type.	Program the scanner to read the type of bar code to be scanned. Scan other bar code(s) and bar code types.
	Incorrect communication parameters.	Set the correct communication parameters (baud rate, parity, stop bits, etc.)
	Bar code symbol is unreadable.	Check the symbol to make sure it is not defaced. Try scanning similar symbols of the same code type.
	Inappropriately hot environment.	Remove the scanner from the hot environment, and allow it to cool down.
Laser activates, followed by a beep sequence.	Beeper is configured.	See <a href="#">Table 3-1 on page 3-7</a> for beeper indication descriptions.
Scanner does not function.	Accidentally scanned <b>Host Trigger</b> , <b>Level Trigger</b> , or <b>Pulse Trigger</b> from <a href="#">Trigger Options on page 3-5</a> .	Download the <i>SSI Demonstration Utility for MiniScan</i> from <a href="http://www.zebra.com/support">http://www.zebra.com/support</a> . Install the utility, then use the utility to change the <b>Trigger Mode</b> parameter 138 (8Ah) to the value 04h (Continuous Mode) via SSI. See <a href="#">Chapter 11, Simple Serial Interface (SSI)</a> , and <a href="#">Trigger Modes on page 10-20</a> . Alternatively, use the utility's soft trigger button to activate the scanner, and scan the <b>Continuous</b> option of the <b>Trigger Mode</b> parameter. Note that this utility does not work with Zebra's non-handshaking interface cable (p/n 25-63736-01R).
		Connect an interface cable which has an external trigger jack, a push button trigger cable, and a power supply to the scanner. You can purchase these cables from Zebra, or make a similar one using the scanner's pinouts as a reference. See the specification chapter for your MiniScan model for pinouts. Using a momentary switch, short the scanner's trigger line to ground to activate the laser, then scan the <b>Continuous</b> option of the <b>Trigger Mode</b> parameter.

- ✓ **NOTE** If after performing these checks the symbol still does not scan, contact the distributor or call Zebra Support at the telephone number listed on [page xv](#).



# Chapter 10 Parameter Menus

---

## Introduction

This chapter describes programmable parameters, and provides bar codes for programming and hexadecimal equivalents for host download programming.

Throughout the programming bar code menus, asterisks (\*) indicate default values.

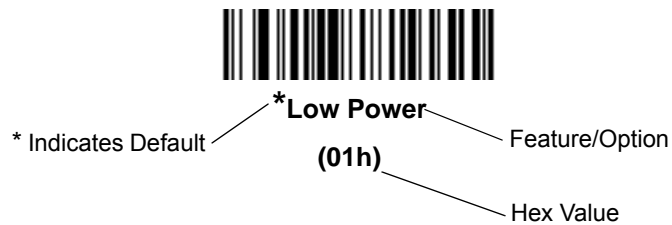

## Operational Parameters

MiniScan scanners ship with the default settings in [Table 10-1 on page 10-2](#). These default values are stored in non-volatile memory and are preserved even when the scanner powers down.

There are two ways to change the default values:

- Scan the appropriate bar codes in this chapter. These new values replace the standard default values in memory. To recall the default parameter values, scan the [Set All Defaults](#) bar code on [page 10-14](#).
- Download data through the scanner's serial port using Zebra's Simple Serial Interface (SSI). Hexadecimal parameter numbers appear in this chapter below the parameter title, and options appear in parenthesis beneath the accompanying bar codes. Refer to the *Simple Serial Interface (SSI) Programmer's Guide* for detailed instructions for changing parameters using this method.

## Default Table

[Table 10-1](#) lists the defaults for all parameters for the MS1204FZY, MS2204, MS2204VHD, MS3204 and the page number on which each parameter appears. For MS954 defaults, see [Default Table for MS954 on page 10-8](#). To change any option, scan the appropriate bar code(s).

**Table 10-1** Default Table for MS1204FZY, MS2204, MS2204VHD, MS3204

Parameter	Parameter Number	Default	Page Number
Set Default Parameter		All Defaults	<a href="#">10-14</a>
<b>Scanning Options</b>			
Beeper Volume	8Ch	High Volume	<a href="#">10-16</a>
Beeper Tone	91h	High Frequency	
Beeper Frequency Adjustment	F07 91h	2500 Hz	<a href="#">10-17</a>
Laser On Time	88h	5.0 sec: MS2204; MS2204VHD; MS3204	<a href="#">10-18</a>
Scan Angle (MS1204FZY)	BFh	Wide	<a href="#">10-18</a>
Power Mode	80h	Low Power	<a href="#">10-19</a>
Trigger Mode	8Ah	Level	<a href="#">10-20</a>
Scanning Mode (MS2204, MS2204VHD, and MS3204 only)	8Dh	Smart Raster	<a href="#">10-21</a>
Aiming Mode	F0h 7Eh	Disabled	<a href="#">10-23</a>
Raster Height (MS2204, MS2204VHD, and MS3204-I000 only)	E4h	15	<a href="#">10-24</a>
Raster Expansion Rate (MS2204, MS2204VHD, and MS3204-I000 only)	E5h	11	<a href="#">10-24</a>

**Table 10-1** Default Table (Continued) for MS1204FZY, MS2204, MS2204VHD, MS3204

Parameter	Parameter Number	Default	Page Number
Time-out Between Same Symbol	89h	0.6 sec	10-25
Time-out Between Different Symbols	90h	0.0 sec	10-25
Beep After Good Decode	38h	Enable	10-26
Transmit "No Read" Message	5Eh	Disable	10-27
Parameter Scanning	ECh	Enable	10-28
Linear Code Type Security Level	4Eh	1: MS1204FZY 2: MS2204; MS2204VHD; MS3204	10-30
Bi-directional Redundancy	43h	Disable	10-32
<b>UPC/EAN</b>			
UPC-A	01h	Enable	10-36
UPC-E	02h	Enable	10-36
UPC-E1	0Ch	Disable	10-37
EAN-8	04h	Enable	10-38
EAN-13	03h	Enable	10-38
Bookland EAN	53h	Disable	10-39
UPC/EAN Coupon Code	55h	Disable	10-40
Decode UPC/EAN Supplementals	10h	Ignore	10-41
User-Programmable Supplementals Supplemental 1: Supplemental 2:	F1h 43h F1h 44h		10-45
Decode UPC/EAN Supplemental Redundancy	50h	20	10-45
Transmit UPC-A Check Digit	28h	Enable	10-47
Transmit UPC-E Check Digit	29h	Enable	10-47
Transmit UPC-E1 Check Digit	2Ah	Enable	10-48
UPC-A Preamble	22h	System Character	10-49
UPC-E Preamble	23h	System Character	10-50
UPC-E1 Preamble	24h	System Character	10-51
Convert UPC-E to A	25h	Disable	10-52
Convert UPC-E1 to A	26h	Disable	10-53

**Table 10-1** Default Table (Continued) for MS1204FZY, MS2204, MS2204VHD, MS3204

Parameter	Parameter Number	Default	Page Number
EAN-8 Zero Extend	27h	Disable	10-53
Bookland ISBN Format	F1h 40h	ISBN-10	10-54
UPC/EAN Security Level	4Dh	0	10-55
Linear UPC/EAN Decode	44h	Disable	10-56
UPC Half Block Stitching (MS2204/ MS2204VHD/MS3204 only)	4Ah	Disable	10-56
<b>Code 128</b>			
Code 128	08h	Enable	10-59
GS1-128 (formerly UCC/EAN-128)	0Eh	Enable	10-59
ISBT 128	54h	Disable Enable: MS1204FZY	10-60
Code 128 Decode Performance (MS2204/MS2204VHD/MS3204 only)	48h	Enable	10-62
Code 128 Decode Performance Level (MS2204/MS2204VHD/MS3204 only)	49h	Level 3	10-63
<b>Code 39</b>			
Code 39	00h	Enable	10-64
Trioptic Code 39	0Dh	Disable	10-64
Convert Code 39 to Code 32	56h	Disable	10-65
Code 32 Prefix	E7h	Enable	10-66
Set Length(s) for Code 39	12h 13h	Length within Range: 02-55:MS1204FZY; 01-55:MS2204; MS2204VHD; MS3204	10-67
Code 39 Check Digit Verification	30h	Disable	10-68
Transmit Code 39 Check Digit	2Bh	Disable	10-68
Code 39 Full ASCII Conversion	11h	Disable	10-69
Code 39 Decode Performance (MS2204/MS2204VHD/MS3204 only)	46h	Enable	10-70
Code 39 Decode Performance Level (MS2204/MS2204VHD/MS3204 only)	47h	Level 3	10-71



**Table 10-1** Default Table (Continued) for MS1204FZY, MS2204, MS2204VHD, MS3204

Parameter	Parameter Number	Default	Page Number
<b>Code 93</b>			
Code 93	09h	Disable	10-72
Set Length(s) for Code 93	1Ah 1Bh	Length within Range: 04-55	10-73
<b>Code 11</b>			
Code 11	0Ah	Disable	10-74
Set Length(s) for Code 11	1Ch 1Dh	Length within Range: 04-55	10-75
Code 11 Check Digit Verification	34h	Disable	10-76
Transmit Code 11 Check Digits	2Fh	Disable	10-77
<b>Interleaved 2 of 5</b>			
Interleaved 2 of 5	06h	Enable	10-78
Set Length(s) for I 2 of 5	16h, 17h	1 Discrete Length: 14	10-79
I 2 of 5 Check Digit Verification	31h	Disable	10-80
Transmit I 2 of 5 Check Digit	2Ch	Disable	10-81
Convert I 2 of 5 to EAN 13	52h	Disable	10-81
<b>Discrete 2 of 5</b>			
Discrete 2 of 5	05h	Disable	10-82
Set Length(s) for D 2 of 5	14h 15h	1 Discrete Length: 12	10-83
<b>Chinese 2 of 5</b>			
Chinese 2 of 5	0cF0 0x98	Disable	10-84
<b>Codabar</b>			
Codabar	07h	Disable	10-90
Set Lengths for Codabar	18h 19h	Length within Range: 05-55	10-91
CLSI Editing	36h	Disable	10-92
NOTIS Editing	37h	Disable	10-92
<b>MSI Plessey</b>			
MSI Plessey	0Bh	Disable	10-94
Set Length(s) for MSI Plessey	1Eh 1Fh	Length Within Range: 06 - 55	10-95
MSI Plessey Check Digits	32h	One	10-96

**Table 10-1** Default Table (Continued) for MS1204FZY, MS2204, MS2204VHD, MS3204

Parameter	Parameter Number	Default	Page Number
Transmit MSI Plessey Check Digit	2Eh	Disable	<a href="#">10-96</a>
MSI Plessey Check Digit Algorithm	33h	Mod 10/Mod 10	<a href="#">10-97</a>
<b>PDF417/MicroPDF417 (MS2204, MS2204VHD, and MS3204 only)</b>			
PDF417	0Fh	MS220X: Enable MS3204: Disable	<a href="#">10-98</a>
MicroPDF417	E3h	Disable	<a href="#">10-98</a>
MicroPDF Performance	F0h 65h	Standard	<a href="#">10-99</a>
Code 128 Emulation	7Bh	Disable	<a href="#">10-100</a>
<b>GS1 DataBar</b>			
GS1 DataBar-14	F0h 52h	Disable	<a href="#">10-101</a>
GS1 DataBar Limited	F0h 53h	Disable	<a href="#">10-101</a>
GS1 DataBar Expanded	F0h 54h	Disable	<a href="#">10-102</a>
Convert GS1 DataBar to UPC/EAN (MS1204FZY only)	F0h 8Dh	Disable	<a href="#">10-104</a>
<b>Composite (MS2204, MS2204VHD and MS3204 only)</b>			
CC-C	F0h 55h	Disable	<a href="#">10-105</a>
CC-AB	F0h 56h	Disable	<a href="#">10-106</a>
TLC-39	F0h 73h	Disable	<a href="#">10-106</a>
UPC Composite Mode	F0h 58h	Always Linked	<a href="#">10-107</a>
<b>Data Options</b>			
Transmit Code ID Character	2Dh	None	<a href="#">10-108</a>
Prefix/Suffix Values			<a href="#">10-110</a>
Prefix	69h	NULL	
Suffix 1	68h	LF	
Suffix 2	6Ah	CR	
Scan Data Transmission Format	EBh	Data as is	<a href="#">10-111</a>
<b>Simple Serial Interface (SSI) Options</b>			
Baud Rate	9Ch	9600	<a href="#">10-113</a>
Parity	9Eh	None	<a href="#">10-117</a>
Check Parity	97h	Enable	<a href="#">10-118</a>
Software Handshaking	9Fh	ACK/NAK	<a href="#">10-119</a>
Host RTS Line State	9Ah	Low	<a href="#">10-120</a>

**Table 10-1** Default Table (Continued) for MS1204FZY, MS2204, MS2204VHD, MS3204

Parameter	Parameter Number	Default	Page Number
Decode Data Packet Format	EEh	Unpacketed	<a href="#">10-121</a>
Stop Bit Select	9Dh	1	<a href="#">10-121</a>
Intercharacter Delay	6Eh	0	<a href="#">10-122</a>
Host Serial Response Time-out	9Bh	2 sec	<a href="#">10-122</a>
Host Character Time-out	EFh	200 msec	<a href="#">10-122</a>
<b>Event Reporting</b>			
Decode Event	F0h 00h	Disable	<a href="#">10-123</a>
Boot Up Event	F0h 02h	Disable	<a href="#">10-124</a>
Parameter Event	F0h 03h	Disable	<a href="#">10-124</a>
<b>Macro PDF (MS2204, MS2204VHD, and MS3204 only)</b>			
Transmit Each Symbol in Codeword Format	Afh	Disable	<a href="#">10-125</a>
Transmit Unknown Codewords	BAh	Disable	<a href="#">10-126</a>
Escape Character	E9h	None	<a href="#">10-127</a>
<b>ECI (MS2204, MS2204VHD and MS3204 only)</b>			
Delete Character Set ECIs	E6h	Enable	<a href="#">10-128</a>
ECI Decoder	E8h	Enable	<a href="#">10-129</a>
<b>Transmit Macro PDF User-Selected Field (MS2204, MS2204VHD, and MS3204 only)</b>			
Transmit File Name	B0h	Disable	<a href="#">10-130</a>
Transmit Block Count	B1h	Disable	<a href="#">10-131</a>
Transmit Time Stamp	B2h	Disable	<a href="#">10-131</a>
Transmit Sender	B3h	Disable	<a href="#">10-132</a>
Transmit Addressee	B4h	Disable	<a href="#">10-132</a>
Transmit Checksum	B6h	Disable	<a href="#">10-133</a>
Transmit File Size	B5h	Disable	<a href="#">10-133</a>
Transmit Macro PDF Control Header	B7h	Disable	<a href="#">10-134</a>
Last Block Marker	B9h	Disable	<a href="#">10-134</a>

## Default Table for MS954

Table 10-2 lists the defaults for all parameters for the MS954 Only, and the page number on which each parameter appears (See Table 10-1 for MS1204FZY, MS2204, MS2204VHD, MS3204 defaults). To change any option, scan the appropriate bar code(s).

**Table 10-2** Default Table for MS954

**Table 11:**

Parameter	Parameter Number	Default	Page Number
Set Default Parameter		All Defaults	10-14
<b>Scanning Options</b>			
Laser On Time	88h	3.0 sec	10-18
Scan Angle	BFh	Wide	10-18
Power Mode	80h	Continuous On	10-19
Trigger Mode	8Ah	Continuous	10-20
Enhanced Aim Timeouts			10-22
Aim Timeout	F2h 55h	2.0 sec	
Scan Timeout	F2h 56h	1.0 sec	
Aiming Mode	F0h 7Eh	Disabled	10-23
Time-out Between Same Symbol	89h	1.0 sec	10-25
Time-out Between Different Symbols	90h	0.0 sec	10-25
Transmit "No Read" Message	5Eh	Disable	10-27
Parameter Scanning	ECh	Enable	10-28
Parameter Pass Through	F1h 71h	Disable	10-29
Linear Code Type Security Level	4Eh	1	10-30
Bi-directional Redundancy	43h	Disable	10-32
<b>Adaptive Scanning</b>			
Adaptive Scanning Mode	F1 CD	Disable	10-33
Adaptive Scanning Interference Suppression Mode	F8h 04h B3h	Interference Suppression Always On	10-34
Adaptive Scanning Interference Suppression Scan Angle	F8h 04h DBh	Wide	10-35

**Table 10-1** Default Table for MS954**Table 11:**

Parameter	Parameter Number	Default	Page Number
<b>UPC/EAN</b>			
UPC-A	01h	Enable	<a href="#">10-36</a>
UPC-E	02h	Enable	<a href="#">10-36</a>
UPC-E1	0Ch	Disable	<a href="#">10-37</a>
EAN-8	04h	Enable	<a href="#">10-38</a>
EAN-13	03h	Enable	<a href="#">10-38</a>
Bookland EAN	53h	Disable	<a href="#">10-39</a>
UPC/EAN Coupon Code	55h	Disable	<a href="#">10-40</a>
Decode UPC/EAN Supplementals	10h	Ignore	<a href="#">10-41</a>
User-Programmable Supplementals Supplemental 1: Supplemental 2:	F1h 43h F1h 44h		<a href="#">10-45</a>
Decode UPC/EAN Supplemental Redundancy	50h	7	<a href="#">10-45</a>
UPC/EAN/JAN Supplemental AIM ID Format	F1h A0h	Combined	<a href="#">10-45</a>
Transmit UPC-A Check Digit	28h	Enable	<a href="#">10-47</a>
Transmit UPC-E Check Digit	29h	Enable	<a href="#">10-47</a>
Transmit UPC-E1 Check Digit	2Ah	Enable	<a href="#">10-48</a>
UPC-A Preamble	22h	System Character	<a href="#">10-49</a>
UPC-E Preamble	23h	System Character	<a href="#">10-50</a>
UPC-E1 Preamble	24h	System Character	<a href="#">10-51</a>
Convert UPC-E to A	25h	Disable	<a href="#">10-52</a>
Convert UPC-E1 to A	26h	Disable	<a href="#">10-53</a>
EAN-8 Zero Extend	27h	Disable	<a href="#">10-53</a>
Bookland ISBN Format	F1h 40h	ISBN-10	<a href="#">10-54</a>
UPC/EAN Security Level	4Dh	0	<a href="#">10-55</a>
Linear UPC/EAN Decode	44h	Disable	<a href="#">10-56</a>
ISSN EAN	F1h 69h	Enable	<a href="#">10-57</a>
Coupon Report	F1h DAh	Both Coupon Formats	<a href="#">10-58</a>

**Table 10-1** Default Table for MS954**Table 11:**

Parameter	Parameter Number	Default	Page Number
<b>Code 128</b>			
Code 128	08h	Enable	<a href="#">10-59</a>
GS1-128 (formerly UCC/EAN-128)	0Eh	Enable	<a href="#">10-59</a>
ISBT 128	54h	Enable	<a href="#">10-60</a>
Check ISBT Table	F1h 42h	Enable	<a href="#">10-60</a>
ISBT Concatenation	F1h 41h	Disable	<a href="#">10-60</a>
<b>Code 39</b>			
Code 39	00h	Enable	<a href="#">10-64</a>
Trioptic Code 39	0Dh	Disable	<a href="#">10-64</a>
Convert Code 39 to Code 32	56h	Disable	<a href="#">10-65</a>
Code 32 Prefix	E7h	Disable	<a href="#">10-66</a>
Set Length(s) for Code 39	12h 13h	Length within Range: 02-55:MS1204FZY; MS954f 01-55:MS2204; MS2204VHD; MS3204	<a href="#">10-67</a>
Code 39 Check Digit Verification	30h	Disable	<a href="#">10-68</a>
Transmit Code 39 Check Digit	2Bh	Disable	<a href="#">10-68</a>
Code 39 Full ASCII Conversion	11h	Disable	<a href="#">10-69</a>
<b>Code 93</b>			
Code 93	09h	Disable	<a href="#">10-72</a>
Set Length(s) for Code 93	1Ah 1Bh	Length within Range: 04-55	<a href="#">10-73</a>
<b>Code 11</b>			
Code 11	0Ah	Disable	<a href="#">10-74</a>
Set Length(s) for Code 11	1Ch 1Dh	Length within Range: 04-55	<a href="#">10-75</a>
Code 11 Check Digit Verification	34h	Disable	<a href="#">10-76</a>
Transmit Code 11 Check Digits	2Fh	Disable	<a href="#">10-77</a>
<b>Interleaved 2 of 5</b>			
Interleaved 2 of 5	06h	Enable	<a href="#">10-78</a>
Set Length(s) for I 2 of 5	16h,17h	1 Discrete Length: 14	<a href="#">10-79</a>
I 2 of 5 Check Digit Verification	31h	Disable	<a href="#">10-80</a>

Table 10-1 Default Table for MS954

Table 11:

Parameter	Parameter Number	Default	Page Number
Transmit I 2 of 5 Check Digit	2Ch	Disable	10-81
Convert I 2 of 5 to EAN 13	52h	Disable	10-81
<b>Discrete 2 of 5</b>			
Discrete 2 of 5	05h	Disable	10-82
Set Length(s) for D 2 of 5	14h 15h	1 Discrete Length: 12	10-83
<b>Chinese 2 of 5</b>			
Chinese 2 of 5	0xF0 0x98	Disable	10-84
<b>Korean 3 of 5</b>			
Korean 3 of 5	F1h 45h	Disable	10-85
<b>Matrix 2 of 5</b>			
Matrix 2 of 5	F1h 6Ah	Disable	10-86
Matrix 2 of 5 Lengths	F1h 6Bh F1h 6Ch	1 Length - 14	10-86
Matrix 2 of 5 Check Digit	F1h 6Eh	Disable	10-89
Transmit Matrix 2 of 5 Check Digit	F1h 6Fh	Disable	10-89
<b>Codabar</b>			
Codabar	07h	Disable	10-90
Set Lengths for Codabar	18h 19h	Length within Range: 05-55	10-91
CLSI Editing	36h	Disable	10-92
NOTIS Editing	37h	Disable	10-92
Codabar Upper or Lower Case Start/Stop Characters Detection	F2h 57h	Lower Case	10-93
<b>MSI Plessey</b>			
MSI Plessey	0Bh	Disable	10-94
Set Length(s) for MSI Plessey	1Eh 1Fh	Length Within Range: 06 - 55	10-95
MSI Plessey Check Digits	32h	One	10-96
Transmit MSI Plessey Check Digit	2Eh	Disable	10-96

**Table 10-1** Default Table for MS954**Table 11:**

Parameter	Parameter Number	Default	Page Number
MSI Plessey Check Digit Algorithm	33h	Mod 10/Mod 10	<a href="#">10-97</a>
<b>GS1 DataBar</b>			
GS1 DataBar-14	F0h 52h	Disable	<a href="#">10-101</a>
GS1 DataBar Limited	F0h 53h	Disable	<a href="#">10-101</a>
GS1 DataBar Expanded	F0h 54h	Disable	<a href="#">10-102</a>
GS1 DataBar Limited Security Level	F1h D8h	Level 3	<a href="#">10-103</a>
Convert GS1 DataBar to UPC/EAN	F0h 8Dh	Disable	<a href="#">10-104</a>
<b>Data Options</b>			
Transmit Code ID Character	2Dh	None	<a href="#">10-108</a>
Prefix/Suffix Values			<a href="#">10-110</a>
Prefix	69h	NULL	
Suffix 1	68h	LF	
Suffix 2	6Ah	CR	
Scan Data Transmission Format	EBh	Data as is	<a href="#">10-111</a>
<b>Simple Serial Interface (SSI) Options</b>			
Baud Rate	9Ch	9600	<a href="#">10-113</a>
Parity	9Eh	Disable	<a href="#">10-117</a>
Check Parity	97h	Disable	<a href="#">10-118</a>
Software Handshaking	9Fh	ACK/NAK	<a href="#">10-119</a>
Host RTS Line State	9Ah	Low	<a href="#">10-120</a>
Decode Data Packet Format	EEh	Unpacketed	<a href="#">10-121</a>
Stop Bit Select	9Dh	1	<a href="#">10-121</a>
Intercharacter Delay	6Eh	0	<a href="#">10-122</a>
Host Serial Response Time-out	9Bh	2 sec	<a href="#">10-122</a>
Host Character Time-out	EFh	200 msec	<a href="#">10-122</a>
<b>Event Reporting</b>			
Decode Event	F0h 00h	Disable	<a href="#">10-123</a>
Boot Up Event	F0h 02h	Disable	<a href="#">10-124</a>



**Table 11:**

<b>Parameter</b>	<b>Parameter Number</b>	<b>Default</b>	<b>Page Number</b>
Parameter Event	F0h 03h	Disable	<i>10-124</i>
<b>Numeric Bar Codes</b>			
Numeric Bar Codes			<i>10-135</i>

---

## Set Default Parameter

### Set Defaults - MS1204, MS1204VHD, MS3204

Scan this bar code to return all parameters to the values listed in [Table 10-1 on page 10-2](#).

✓ **NOTE** See [Set Defaults - MS954 on page 10-15](#) for the MS954 default parameters.



**Set All Defaults**

## Set Defaults - MS954

The MS954 ships with the factory default settings in [Table 10-1 on page 10-2](#). These factory default values are stored in non-volatile memory and are preserved even when the scanner powers down. You can store changes to the factory default values as custom defaults. These values are also stored in non-volatile memory and are preserved even when the scanner powers down.

- Scan the appropriate bar code below to reset the MS954 to its default settings and/or set the scanner's current settings as the custom default.
- **Restore Defaults** - Scan this bar code to reset all default parameters as follows.
  - If you previously set custom defaults by scanning **Write to Custom Defaults**, scan **Restore Defaults** to retrieve and restore the scanner's custom default settings.
  - If you did not set custom defaults, scan **Restore Defaults** to restore the factory default values in [Table 8-1 on page 8-2](#).
- **Set Factory Defaults** - Scan this bar code to restore the factory default values in [Table 8-1 on page 8-2](#). This eliminates any custom defaults set.
- **Write to Custom Defaults** - Scan this bar code to store the current scanner settings as custom defaults. Once custom default settings are stored, you can recover them at any time by scanning **Restore Defaults**.



\* **Restore Defaults**



**Set Factory Defaults**



**Write to Custom Defaults**

---

## Scanning Options

### Beeper Volume

#### Parameter # 140

To select a decode beep volume, scan the **Low Volume**, **Medium Volume**, or **High Volume** bar code.



**Low Volume**



**Medium Volume**



**\*High Volume**

## Beeper Tone

### Parameter # 91h

To select a decode beep frequency (tone), scan the appropriate bar code.

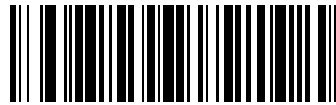

Low Frequency  
(02h)



Medium Frequency  
(01h)

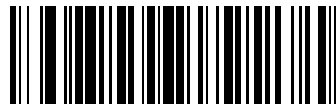

\*High Frequency  
(00h)

## Beeper Frequency Adjustment

### Parameter # F0h 91H

This parameter adjusts the frequency of the high beeper tone from the nominal 2500 Hz to another frequency matching the resonances of the installation. Program this in 10 Hz increments from 1220 Hz to 3770 Hz.

To increase the frequency, scan the bar code below, then scan three numeric bar codes beginning on [page 10-135](#) that correspond to the desired frequency adjustment divided by 10. For example, to set the frequency to 3000 Hz (an increase of 500 Hz), scan numeric bar codes 0, 5, 0, corresponding to 50, or (500/10).

To decrease the frequency, scan the bar code below, then scan three numeric bar codes beginning on [page 10-135](#) that correspond to the value (256 - desired adjustment/10). For example, to set the frequency to 2000 Hz (a decrease of 500 Hz), scan numeric bar codes 2, 0, 6, corresponding to 206, or (256 - 500/10).



Beeper Frequency Adjustment

## Laser On Time

### Parameter # 88h

This parameter sets the maximum time decode processing continues during a scan attempt. It is programmable in 0.1 second increments from 0.5 to 9.9 seconds.

To set a Laser On Time, scan the bar code below. Next scan two numeric bar codes beginning on [page 10-135](#) that correspond to the desired on time. Enter a leading zero for times less than 1.0 second. For example, to set an on time of 0.5 seconds, scan the bar code below, then scan the 0 and 5 bar codes. To change the selection or to cancel an incorrect entry, scan the [Cancel](#) bar code on [page 10-137](#)

The **Laser on Time** default for the MS954 is 3.0 Seconds. The default for the MS2204, MS2204VHD and MS3204 is 5.0 Seconds.



Laser On Time

## Scan Angle

### Parameter # BFh



**NOTE** Only the MS1204FZY and MS954 support this option.

This parameter sets the scan angle.

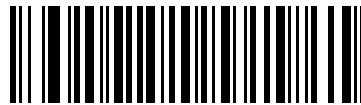

\*Default Angle (Wide)  
(06h)



Alternate Angle (Narrow)  
(05h)

## Power Mode

### Parameter # 80h

✓ **NOTE** For the MS954, the *Power Mode* default is **Continuous On**. For the MS1204FZY, MS2204, MS2204VHD, and MS3204, the default is **Low Power**.

This parameter determines whether or not power remains on after a decode attempt. In **Low Power** mode, the scanner enters into a low power consumption mode when possible, provided all WAKEUP signals are released. In **Continuous On** mode, power remains on after each decode attempt.



**Continuous On  
(00h)**



**Low Power  
(01h)**

## Trigger Modes

### Parameter # 8Ah

✓ **NOTE** The *Trigger Mode* default is **Continuous** for the MS954 only.

- **Level** - A trigger pull activates the laser and decode processing. The laser remains on and decode processing continues until a trigger release, a valid decode, or the Laser On Time-out occurs.
- **Pulse** - A trigger pull activates the laser and decode processing. The laser remains on and decode processing continues until a valid decode or the Laser On Time-out occurs.
- **Continuous** - The laser is always on and decoding.
- **Blink** - This trigger mode is used for triggerless presentation mode (scanstand) operation. Scanning range is reduced in this mode. Only the MS1204FZY and MS954 support this mode.
- **Host** - A host command issues the triggering signal. The scanner interprets an actual trigger pull as a Level triggering option.



\*Level  
(00h)



Pulse  
(02h)



Continuous  
(04h)

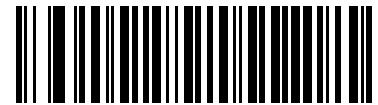

Blink  
(07h)



Host  
(08h)



## Scanning Mode

### Parameter # 8Dh

✓ **NOTE** This option is supported by the MS2204, MS2204VHD and MS3204 only.

Select one of the following scanning modes:

- Smart Raster
- Slab Only Raster
- Omnidirectional (Cyclone)
- Always Raster
- Programmable Raster
- Semi-Omnidirectional

✓ **NOTE** If you select **Omnidirectional**, Zebra recommends disabling the following parameters: PDF417, MicroPDF417, DataBar Limited, CC-C, CC-AB, TLC-39 and Linear UPC.



\* Smart Raster  
(01h)



Always Raster  
(02h)



Programmable Raster  
(03h)



Slab Pattern  
(04h)



Omnidirectional Pattern  
(06h)



Semi-Omni Pattern  
(07h)

## Enhanced Aim Timeouts

✓ **NOTE** Only the MS954 (manufactured on/after July 1, 2014) supports this option.

### Aim Timeout: Parameter # F2h 55h

### Scan Timeout: Parameter # F2h 56h

If you selected **Enhanced Aim** as the trigger mode, select an aim timeout and a scan timeout:

1. Scan the **Aim Timeout** or **Scan Timeout** bar code below.
2. Scan two numeric bar codes beginning on [page 10-135](#) that correspond to the desired timeout. Single digit values must have a leading zero. For example, to set a timeout of 0.5 seconds, scan the bar code below, then scan the **0** and **5** bar codes. To change the selection or cancel an incorrect entry, scan [Cancel on page 10-137](#).

The **Aim Timeout** value must be in the range of 0.0 - 9.9, and the default is 2.0 seconds.

The **Scan Timeout** value must be in the range of 0.5 - 9.9, and the default is 1.0 second.



**Aim Timeout**



**Scan Timeout**

## Aiming Mode

### Parameter # F0h 7Eh

✓ **NOTE** Only the MS1204FZY, MS2204, MS2204VHD, and MS3204 support this option.

For handheld mode only, select an aiming dot to appear for a normal or extended period of time.



**\*No Aiming Dot  
(00h)**



**Aiming Dot  
Normal (200 ms) Timeout  
(01h)**



**Aiming Dot  
Extended (400 ms) Timeout  
(02h)**

## Programmable Raster Height And Raster Expansion Speed

### Parameter # E4h, E5h

✓ **NOTE** Only the MS2204, MS2204VHD, and MS3204-I000 support this option.

This parameter selects the laser pattern's height and rate of expansion if you enabled Programmable Raster or Always Raster. This parameter is intended for very specific applications, and is usually not necessary.

Select the laser pattern's height and/or rate of expansion.

1. Scan the bar code for either **Raster Height** or **Raster Expansion Speed** below.
2. Scan two numeric bar codes beginning on [page 10-135](#) that represent a two-digit value. Valid values are between 01 and 15.

To change the selection or to cancel an incorrect entry, scan [Cancel on page 10-137](#).



**Raster Height (Default 15)**



**Raster Expansion Speed (Default 11)**

## Timeout Between Decodes

### Timeout Between Decodes, Same Symbol

#### Parameter # 89h

When in Continuous triggering mode, this parameter sets the minimum duration of not decoding data before the scanner decodes a second bar code identical to one just decoded. This reduces the risk of accidentally scanning the same symbol twice. It is programmable in 0.1 second increments from 0.0 to 9.9 seconds. The recommended interval is 1.0 seconds.

### Timeout Between Decodes, Different Symbol

#### Parameter # 90h

This option sets the minimum duration of not decoding data before the scanner decodes a second (different) bar code. Use this in continuous-on mode to prevent the beeper from beeping when a different symbol appears in the scanner's field of view before the timeout period between decodes expires. This is programmable in 0.1 second increments from 0.0 to 9.9 seconds. The recommended value is 0.0 seconds.

Select the timeouts between decodes for the same or different symbols.

1. Scan the option bar code to set.
2. Scan two numeric bar codes beginning on [page 10-135](#) which correspond to the desired interval, in 0.1 second increments.

To change the selection or to cancel an incorrect entry, scan the [Cancel](#) bar code on [page 10-137](#).



Timeout Between Decodes -  
Same Symbol



Timeout Between Decodes -  
Different Symbols

## **Beep After Good Decode**

### **Parameter # 38h**

Scan this symbol to set the scanner to beep after a good decode.



**\*Beep After Good Decode  
(01h)**

Scan this symbol to set the scanner not to beep after a good decode. The beeper still operates during parameter menu scanning and indicates error conditions.

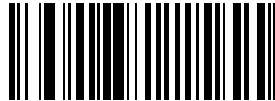

**Do Not Beep After Good Decode  
(00h)**

## Transmit "No Read" Message

### Parameter # 5Eh

Enable this option to transmit "NR" if a symbol does not decode. Any enabled prefix or suffixes are appended around this message.



**Enable No Read  
(01h)**

Disable this parameter to send no message to the host if the scanner cannot decode a symbol.



**\*Disable No Read  
(00h)**

## Parameter Scanning

### Parameter # ECh

To disable the decoding of parameter bar codes, scan the bar code below. The scanner can still decode the **Set Defaults** parameter bar code. To enable decoding parameter bar codes, either scan *\*Enable Parameter Scanning (01h)*, *Set All Defaults* or set this parameter to 01h via a serial command.



**\*Enable Parameter Scanning  
(01h)**



**Disable Parameter Scanning  
(00h)**



## Parameter Pass Through

✓ **NOTE** Only the MS954 (manufactured on/after July 1, 2014) supports this option.

### Parameter # F1h 71h

Enable **Parameter Pass Through** to transmit bar codes in the following format, in Code 128, to the host:

<FNC3>L<any length data>

<FNC3>B<12 characters of data>

Note that the special Code 128 character <FNC3> must appear at the beginning of this data. However, if the appropriate data does not follow this as shown above, it does not transmit to the host device.

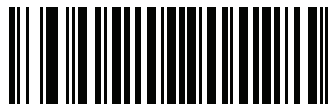

**Enable User Parameter Pass Through  
(01h)**

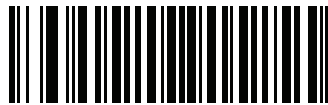

**\*Disable User Parameter Pass Through  
(00h)**

## Linear Code Type Security Level

### Parameter # 4Eh

✓ **NOTE** Does not apply to Code 128.

The MiniScan scanner offer four levels of decode security for linear code types (e.g., Code 39, Interleaved 2 of 5). Select higher security levels for decreasing levels of bar code quality. As security levels increase, the scanner's aggressiveness decreases.

Select the security level appropriate for your bar code quality.

### Linear Security Level 1

The scanner must successfully read the following code types twice before decoding:

Code Type	Length
Codabar	All
MSI Plessey	4 or less
D 2 of 5	8 or less
I 2 of 5	8 or less

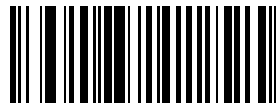

\*Linear Security Level 1  
(01h)

### Linear Security Level 2

The scanner must successfully read all code types twice before decoding.



\*Linear Security Level 2  
(02h)

### Linear Security Level 3

The scanner must successfully read code types other than the following twice before decoding. It must successfully read the following codes three times:

Code Type	Length
MSI Plessey	4 or less
D 2 of 5	8 or less
I 2 of 5	8 or less



Linear Security Level 3  
(03h)

### Linear Security Level 4

The scanner must successfully read all code types before decoding.

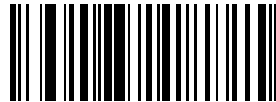

Linear Security Level 4  
(04h)

## Bi-directional Redundancy

### Parameter # 43h

This parameter is only valid if you enabled a *Linear Code Type Security Level* (see [page 10-30](#)). If you enable this, the scanner must successfully scan a bar code in both directions (forward and reverse) before decoding.



**Enable Bi-directional Redundancy  
(01h)**



**\*Disable Bi-directional Redundancy  
(00h)**

---

## Adaptive Scanning



**NOTE** Only the MS954 (manufactured on/after July 1, 2014) supports this option.

### Parameter # F1 CD

The MS954 offers adaptive scanning. The scan engine in the MS954 uses a range finder to provide feedback on how far away a bar code is when scanning, and automatically optimizes parameters to improve decode performance. These parameters include bandwidth, receiver gain, digitizer settings and scan angle.

Scan a bar code below to enable or disable adaptive scanning.

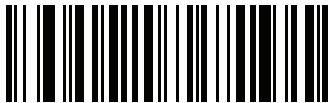

**Enable Adaptive Scanning  
(01h)**

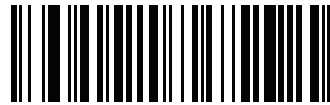

**\*Disable Adaptive Scanning  
(00h)**

## Adaptive Scanning (continued)

### Interference Suppression Mode

✓ **NOTE** Only the MS954 (manufactured on/after July 1, 2014) supports this option.

#### Parameter # F8h 04h B3h

- Disable Interference Suppression: Reduced working range is possible in the presence of interfering ambient light.
- Interference Suppression Always On: Recommended only if the scanner is always in the presence of interfering ambient light.
- Ambient Light Interference Suppression Auto Detection: The scan angle changes from wide angle to medium angle in the presence of interfering ambient light only when **Interference Suppression Scan Angle** is set to Medium.



Disable Interference Suppression  
(00h)



\*Interference Suppression Always On  
(01h)



Ambient Light Interference Suppression  
Auto Detection  
(02h)

## Adaptive Scanning (continued)

### Interference Suppression Scan Angle

- ✓ **NOTE** Only the MS954 (manufactured on/after July 1, 2014) supports this option.

#### Parameter # F8h 04h DBh

- Medium Interference Suppression Scan Angle: Recommended for maximum working range in the presence of interfering ambient light.
- Wide Interference Suppression Scan Angle: This is recommended for use applications where no change in scan angle is desired. Reduced working range is possible on certain bar codes in various lighting conditions. Using **Interference Suppression Scan Angle - Medium** can improve working range in this circumstance.



Interference Suppression Scan Angle - Medium  
(01h)

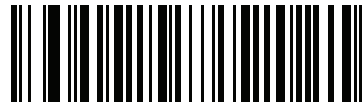

\*Interference Suppression Scan Angle - Wide  
(02h)

---

## UPC/EAN

### Enable/Disable UPC-A

#### Parameter # 01h

To enable or disable UPC-A, scan the appropriate bar code below.



**\*Enable UPC-A  
(01h)**

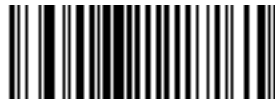

**Disable UPC-A  
(00h)**

### Enable/Disable UPC-E

#### Parameter # 02h

To enable or disable UPC-E, scan the appropriate bar code below.

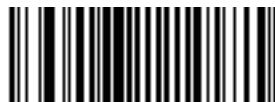

**\*Enable UPC-E  
(01h)**

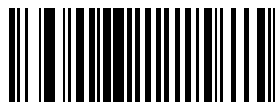

**Disable UPC-E  
(00h)**



**Enable/Disable UPC-E1****Parameter # 0Ch**

To enable or disable UPC-E1, scan the appropriate bar code below.



**Enable UPC-E1  
(01h)**



**\*Disable UPC-E1  
(00h)**

## Enable/Disable EAN-8

### Parameter # 04h

To enable or disable EAN-8, scan the appropriate bar code below.

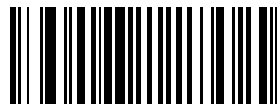

**\*Enable EAN-8  
(01h)**

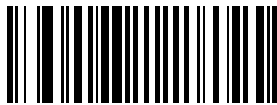

**Disable EAN-8  
(00h)**

## Enable/Disable EAN-13

### Parameter # 03h

To enable or disable EAN-13, scan the appropriate bar code below.

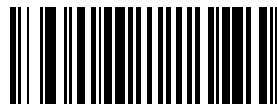

**\*Enable EAN-13  
(01h)**

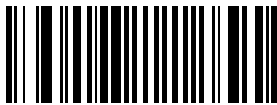

**Disable EAN-13  
(00h)**

## Enable/Disable Bookland EAN

### Parameter # 53h

To enable or disable EAN Bookland, scan the appropriate bar code below.



**Enable Bookland EAN  
(01h)**



**\*Disable Bookland EAN  
(00h)**



**NOTE** If you enable Bookland EAN, select a [Bookland ISBN Format on page 10-54](#). Also select either Decode UPC/EAN Supplementals, Autodiscriminate UPC/EAN Supplementals, or Enable 978/979 Supplemental Mode in [Decode UPC/EAN Supplementals on page 10-41](#).

## UPC/EAN Coupon Code

### Parameter # 55h

Enable this parameter to decode UPC-A bar codes starting with digit '5', EAN-13 bar codes starting with digit '99', and UPC-A/EAN-128 Coupon Codes. UPC-A, EAN-13 and EAN-128 must be enabled to scan all types of Coupon Codes.



**Enable UPC/EAN  
Coupon Code**



**\*Disable UPC/EAN  
Coupon Code**



**NOTE** Use [Decode UPC/EAN Supplemental Redundancy on page 10-45](#) to control autodiscrimination of the EAN-128 (right half) of a coupon code.

## Decode UPC/EAN Supplementals

### Parameter # 10h

Supplementals are bar codes appended according to specific format conventions (e.g., UPC A+2, UPC E+2, EAN 13+2). The following options are available:

- If you select **Ignore UPC/EAN with Supplementals**, and the scanner is presented with a UPC/EAN plus supplemental symbol, the scanner decodes UPC/EAN and ignores the supplemental characters.
- If you select **Decode UPC/EAN with Supplementals**, the scanner only decodes UPC/EAN symbols with supplemental characters, and ignores symbols without supplementals.
- If you select **Autodiscriminate UPC/EAN Supplementals**, the scanner decodes UPC/EAN symbols with supplemental characters immediately. If the symbol does not have a supplemental, the scanner must decode the bar code the number of times set via [Decode UPC/EAN Supplemental Redundancy on page 10-45](#) before transmitting its data to confirm that there is no supplemental.
- If you select one of the following **Supplemental Mode** options, the scanner immediately transmits EAN-13 bar codes starting with that prefix that have supplemental characters. If the symbol does not have a supplemental, the scanner must decode the bar code the number of times set via [Decode UPC/EAN Supplemental Redundancy on page 10-45](#) before transmitting its data to confirm that there is no supplemental. The scanner transmits UPC/EAN bar codes that do not have that prefix immediately.
  - **Enable 378/379 Supplemental Mode**
  - **Enable 978/979 Supplemental Mode**

✓ **NOTE** If you select 978/979 Supplemental Mode and are scanning Bookland EAN bar codes, see [Enable/Disable Bookland EAN on page 10-39](#) to enable Bookland EAN, and select a format using [Bookland ISBN Format on page 10-54](#).

- **Enable 977 Supplemental Mode**
- **Enable 414/419/434/439 Supplemental Mode**
- **Enable 491 Supplemental Mode**
- **Enable Smart Supplemental Mode** - applies to EAN-13 bar codes starting with any prefix listed previously.
- **Supplemental User-Programmable Type 1** - applies to EAN-13 bar codes starting with a 3-digit user-defined prefix. Set this 3-digit prefix using [User-Programmable Supplementals on page 10-45](#).
- **Supplemental User-Programmable Type 1 and 2** - applies to EAN-13 bar codes starting with either of two 3-digit user-defined prefixes. Set the 3-digit prefixes using [User-Programmable Supplementals on page 10-45](#).
- **Smart Supplemental Plus User-Programmable 1** - applies to EAN-13 bar codes starting with any prefix listed previously or the user-defined prefix set using [User-Programmable Supplementals on page 10-45](#).
- **Smart Supplemental Plus User-Programmable 1 and 2** - applies to EAN-13 bar codes starting with any prefix listed previously or one of the two user-defined prefixes set using [User-Programmable Supplementals on page 10-45](#).

✓ **NOTE** To minimize the risk of invalid data transmission, select either to decode or ignore supplemental characters.

## Decode UPC/EAN Supplementals (continued)

Select an option by scanning one of the following bar codes.

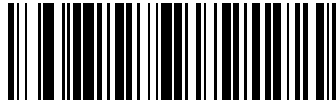

**Decode UPC/EAN With Supplementals  
(01h)**

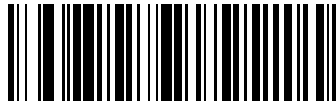

**\*Ignore UPC/EAN Supplementals  
(00h)**

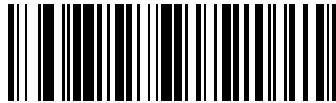

**Autodiscriminate UPC/EAN Supplementals  
(02h)**



**Enable 378/379 Supplemental Mode  
(04h)**



**Enable 978/979 Supplemental Mode  
(05h)**

**Decode UPC/EAN Supplementals (continued)**

**Enable 977 Supplemental Mode  
(07h)**



**Enable 414/419/434/439 Supplemental Mode  
(06h)**



**Enable 491 Supplemental Mode  
(08h)**



**Enable Smart Supplemental Mode  
(03h)**

## Decode UPC/EAN Supplementals (continued)



**Supplemental User-Programmable Type 1  
(09h)**



**Supplemental User-Programmable Type 1 and 2  
(0Ah)**



**Smart Supplemental Plus User-Programmable 1  
(0Bh)**



**Smart Supplemental Plus User-Programmable 1 and 2  
(0Ch)**



## User-Programmable Supplementals

### Supplemental 1: Parameter # F1h 43h

### Supplemental 2: Parameter # F1h 44h

If you selected a Supplemental User-Programmable option from *Decode UPC/EAN Supplementals on page 10-41*, select **User-Programmable Supplemental 1** to set the 3-digit prefix. Then select the 3 digits using the numeric bar codes beginning on *page 10-135*. Select **User-Programmable Supplemental 2** to set a second 3-digit prefix. Then select the 3 digits using the numeric bar codes beginning on *page 10-135*.



User-Programmable Supplemental 1



User-Programmable Supplemental 2

## Decode UPC/EAN Supplemental Redundancy

### Parameter # 50h

If you selected *Autodiscriminate UPC/EAN Supplementals*, use this option to adjust the number of times (from 2 to 30) to decode a symbol without supplementals before transmission. Five or above is recommended when decoding a mix of UPC/EAN symbols with and without supplementals.

✓ **NOTE** The default supplemental redundancy for MS954 is 7.

Scan the bar code below to select a decode redundancy value. Next scan two numeric bar codes beginning on *page 10-135*. Enter a leading zero for single digit numbers. To change the selection or to cancel an incorrect entry, scan the *Cancel* bar code on *page 10-137*.

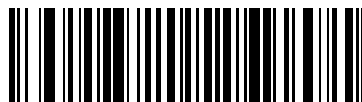

Decode UPC/EAN  
Supplemental Redundancy

## UPC/EAN/JAN Supplemental AIM ID Format

✓ **NOTE** Only the MS954 (manufactured on/after July 1, 2014) supports this option.

### Parameter # F1h A0h

Select an output format when reporting UPC/EAN/JAN bar codes with supplementals with AIM ID enabled:

- Separate - UPC/EAN with supplementals transmit as ]E<0 or 4><data>]E<1 or 2>[supp data]
- Combined - EAN-8 with supplementals transmit as ]E4<data>]E<1 or 2>[supp data]  
All other UPC/EAN with supplementals transmit as ]E3<data+supps>



Separate  
(00h)



\*Combined  
(01h)

**Transmit UPC-A Check Digit****Parameter # 28h**

Scan the appropriate bar code below to transmit the symbol with or without the UPC-A check digit.



**\*Transmit UPC-A Check Digit  
(01h)**



**Do Not Transmit UPC-A Check Digit  
(00h)**

**Transmit UPC-E Check Digit****Parameter # 29h**

Scan the appropriate bar code below to transmit the symbol with or without the UPC-E check digit.

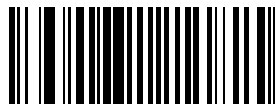

**\*Transmit UPC-E Check Digit  
(01h)**

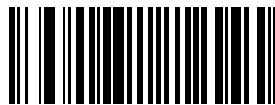

**Do Not Transmit UPC-E Check Digit  
(00h)**

## Transmit UPC-E1 Check Digit

### Parameter # 2Ah

Scan the appropriate bar code below to transmit the symbol with or without the UPC-E1 check digit.



**\*Transmit UPC-E1 CHECK DIGIT  
(01h)**



**Do Not Transmit UPC-E1 Check Digit  
(00h)**

## UPC-A Preamble

### Parameter # 22h

Preamble characters (Country Code and System Character) can transmit as part of a UPC-A symbol. Select one of the following options for transmitting UPC-A preamble to the host device: transmit system character only, transmit system character and country code ("0" for USA), or transmit no preamble.



**No Preamble**  
(<DATA>)  
(00h)

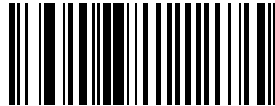

**\*System Character**  
(<SYSTEM CHARACTER> <DATA>)  
(01h)

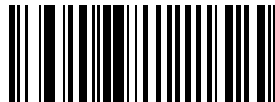

**System Character & Country Code**  
(< COUNTRY CODE> <SYSTEM CHARACTER> <DATA>)  
(02h)

## UPC-E Preamble

### Parameter # 23h

Preamble characters (Country Code and System Character) can transmit as part of a UPC-E symbol. Select one of the following options for transmitting UPC-E preamble to the host device: transmit system character only, transmit system character and country code ("0" for USA), or transmit no preamble.



**No Preamble**  
(<DATA>  
(00h)



**\*System Character**  
(<SYSTEM CHARACTER> <DATA>  
(01h)



**System Character & Country Code**  
(< COUNTRY CODE> <SYSTEM CHARACTER> <DATA>  
(02h)

## UPC-E1 Preamble

### Parameter # 24h

Preamble characters (Country Code and System Character) can transmit as part of a UPC-E1 symbol. Select one of the following options for transmitting UPC-E1 preamble to the host device: transmit system character only, transmit system character and country code ("0" for USA), or transmit no preamble.



**No Preamble**  
(<DATA>)  
(00h)



**\*System Character**  
(<SYSTEM CHARACTER> <DATA>)  
(01h)



**System Character & Country Code**  
(< COUNTRY CODE> <SYSTEM CHARACTER> <DATA>)  
(02h)

## Convert UPC-E to UPC-A

### Parameter # 25h

This parameter converts UPC-E (zero suppressed) decoded data to UPC-A format before transmission. After conversion, data follows UPC-A format and is affected by UPC-A programming selections (e.g., Preamble, Check Digit).

Scan **DO NOT CONVERT UPC-E TO UPC-A** to transmit UPC-E (zero suppressed) decoded data.

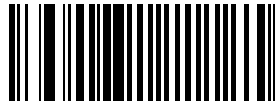

**Convert UPC-E To UPC-A  
(Enable)  
(01h)**

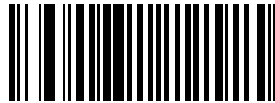

**\*Do Not Convert UPC-E To UPC-A  
(Disable)  
(00h)**



## Convert UPC-E1 to UPC-A

### Parameter # 26h

Enable this parameter to convert UPC-E1 (zero suppressed) decoded data to UPC-A format before transmission. After conversion, data follows UPC-A format and is affected by UPC-A programming selections (e.g., Preamble, Check Digit).

Scan **DO NOT CONVERT UPC-E TO UPC-A** to transmit UPC-E1 (zero suppressed) decoded data.



**Convert UPC-E1 To UPC-A  
(Enable)  
(01h)**



**\*Do Not Convert UPC-E1 To UPC-A  
(Disable)  
(00h)**

## EAN Zero Extend

### Parameter # 27h

Enable this parameter to add five leading zeros to decoded EAN-8 symbols to make them compatible in format to EAN-13 symbols.

Disable this parameter to transmit EAN-8 symbols as is.

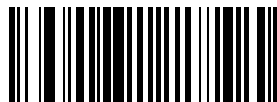

**Enable EAN Zero Extend  
(01h)**

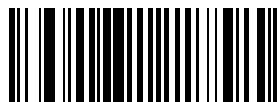

**\*Disable EAN Zero Extend  
(00h)**

## Bookland ISBN Format

### Parameter # F1h 40h

If you enabled Bookland EAN using [Enable/Disable Bookland EAN on page 10-39](#), select one of the following formats for Bookland data:

- **Bookland ISBN-10** - The scanner reports Bookland data starting with 978 in traditional 10-digit format with the special Bookland check digit for backward-compatibility. Data starting with 979 is not considered Bookland in this mode.
- **Bookland ISBN-13** - The scanner reports Bookland data (starting with either 978 or 979) as EAN-13 in 13-digit format to meet the 2007 ISBN-13 protocol.



**\*Bookland ISBN-10**  
(00h)



**Bookland ISBN-13**  
(01h)



**NOTE** For Bookland EAN to function properly, first enable Bookland EAN using [Enable/Disable Bookland EAN on page 10-39](#), then select either Decode UPC/EAN Supplementals, Autodiscriminate UPC/EAN Supplementals, or Enable 978/979 Supplemental Mode in [Decode UPC/EAN Supplementals on page 10-41](#).

## UPC/EAN Security Level

### Parameter # 4Dh

The MiniScan scanner offers four levels of decode security for UPC/EAN bar codes. Select higher levels of security for decreasing levels of bar code quality. Increasing security decreases the scanner's aggressiveness, so choose only that level of security necessary for the application.

#### UPC/EAN Security Level 0

This default setting allows the scanner to operate in its most aggressive state, while providing sufficient security in decoding "in-spec" UPC/EAN bar codes.

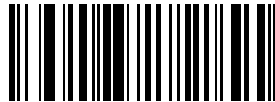

**\*UPC/EAN Security Level 0**  
(00h)

#### UPC/EAN Security Level 1

Select this option if misdecodes occur. This security level eliminates most misdecodes.



**UPC/EAN Security Level 1**  
(01h)

#### UPC/EAN Security Level 2

Select this option if Security level 1 fails to eliminate misdecodes.



**UPC/EAN Security Level 2**  
(02h)

#### UPC/EAN Security Level 3

If misdecodes still occur after selecting Security Level 2, select this security level. Be advised, selecting this option is an extreme measure against misdecoding severely out of spec bar codes. Selecting this level of security significantly impairs the decoding ability of the scanner. If this level of security is necessary, try to improve the quality of the bar codes.



**UPC/EAN Security Level 3**  
(03h)

## Linear UPC/EAN Decode

### Parameter # 44h

This option applies to code types containing two adjacent blocks (e.g., UPC-A, EAN-8, EAN-13). Enable this to transmit a bar code only when the scanner successfully decodes both the left and right blocks with one laser scan. Enable this option when bar codes are in proximity to each other.

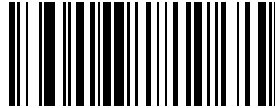

Enable Linear UPC/EAN Decode  
(01h)

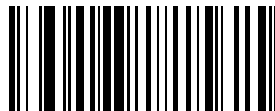

\*Disable Linear UPC/EAN Decode  
(00h)

## UPC Half Block Stitching

### Parameter # 4Ah

✓ **NOTE** Only the MS2204, MS2204VHD, and MS3204 support this option.

This parameter enables UPC Half Block Stitching.

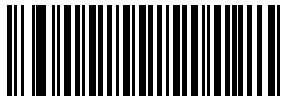

Enable UPC Half Block Stitching  
(01h)



\*Disable UPC Half Block Stitching  
(00h)

## ISSN EAN

### Parameter # F1h 69h

✓ **NOTE** Only the MS954 (manufactured on/after July 1, 2014) supports this option.

To enable or disable ISSN EAN, scan the appropriate bar code below.



**\*Enable ISSN EAN  
(01h)**



**Disable ISSN EAN  
(00h)**

## Coupon Report

✓ **NOTE** Only the MS954 (manufactured on/after July 1, 2014) supports this option.

### Parameter # F1h DAh

Traditional coupon symbols (old coupon symbols) are composed of two bar codes: UPC/EAN and Code128. A new coupon symbol is composed of a single Databar Expanded bar code. The new coupon format offers more options for purchase values (up to \$999.99) and supports complex discount offers such as a second purchase requirement.

An interim coupon symbol also exists that contains both types of bar codes: UPC/EAN and Databar Expanded. This format accommodates both retailers that do not recognize or use the additional information included in the new coupon symbol, as well as those who can process new coupon symbols.

Scan a bar code below to select one of the following options for decoding coupon symbols:

- **Old Coupon Symbols** - Scanning an old coupon symbol reports both UPC and Code 128, scanning an interim coupon symbol reports UPC, and scanning a new coupon symbol reports nothing (no decode).
- **New Coupon Symbols** - Scanning an old coupon symbol reports either UPC or Code 128, and scanning an interim coupon symbol or a new coupon symbol reports Databar Expanded.
- **Both Coupon Formats** - Scanning an old coupon symbol reports both UPC and Code 128, and scanning an interim coupon symbol or a new coupon symbol reports Databar Expanded.



**Old Coupon Symbols  
(00h)**



**New Coupon Symbols  
(01h)**



**\*Both Coupon Formats  
(02h)**

---

## Code 128

### Enable/Disable Code 128

#### Parameter # 08h

To enable or disable Code 128, scan the appropriate bar code below.

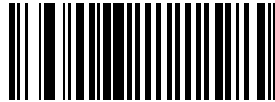

**\*Enable Code 128  
(01h)**



**Disable Code 128  
(00h)**

### Enable/Disable GS1-128 (formerly UCC/EAN-128)

#### Parameter # 0Eh

To enable or disable GS1-128, scan the appropriate bar code below.

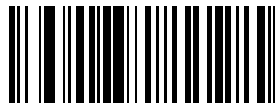

**\*Enable GS1-128  
(01h)**

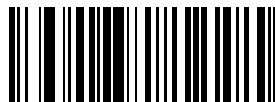

**Disable GS1-128  
(00h)**

## Enable/Disable ISBT 128

### Parameter # 54h

✓ **NOTE** Only the MS954 (manufactured on/after July 1, 2014) supports this option.

To enable or disable ISBT 128, scan the appropriate bar code below.



**\*Enable ISBT 128  
(01h)**



**Disable ISBT 128  
(00h)**



## ISBT Concatenation

✓ **NOTE** Only the MS954 (manufactured on/after July 1, 2014) supports this option..

### Parameter # F1h 41h

Select an option for concatenating pairs of ISBT code types:

- If you select **Disable ISBT Concatenation**, the device does not concatenate pairs of ISBT codes it encounters.
- If you select **Enable ISBT Concatenation**, there must be two ISBT codes in order for the device to decode and perform concatenation. The device does not decode single ISBT symbols.
- If you select **Autodiscriminate ISBT Concatenation**, the device decodes and concatenates pairs of ISBT codes immediately.



\*Disable ISBT Concatenation  
(00h)

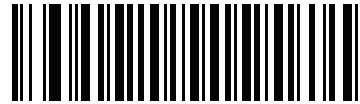

Enable ISBT Concatenation  
(01h)



Autodiscriminate ISBT Concatenation  
(02h)

### Lengths for Code 128

No length setting is required for Code 128.

## Code 128 Decode Performance

### Parameter # 48h

✓ **NOTE** Only the MS2204, MS2204VHD, and MS3204 support this option

This option offers three levels of decode performance or “aggressiveness” for Code 128 symbols. Increasing the performance level reduces the amount of required bar code orientation, which is useful when scanning very long and/or truncated bar codes. Increased levels reduce decode security.

If you enable this option, you can select a Decode Performance level from the next page to suit performance needs.



**\*Enable Code 128 Decode Performance  
(01h)**



**Disable Code 128 Decode Performance  
(00h)**

## Code 128 Decode Performance Level

### Parameter # 49h

✓ **NOTE** Only the MS2204, MS2204VHD, and MS3204 support this option

Select a level of decode performance.

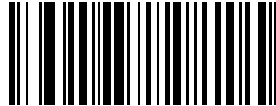

Code 128 Decode Performance Level 1  
(03h)

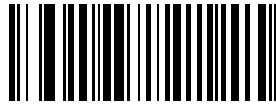

Code 128 Decode Performance Level 2  
(02h)

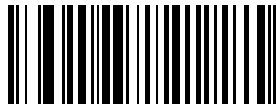

\*Code 128 Decode Performance Level 3  
(01h)

---

## Code 39

### Enable/Disable Code 39

#### Parameter # 00h

To enable or disable Code 39, scan the appropriate bar code below.

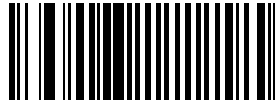

**\*Enable Code 39**  
(01h)

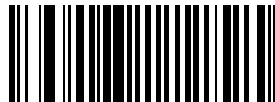

**Disable Code 39**  
(00h)

### Enable/Disable Trioptic Code 39

#### Parameter # 0Dh

Trioptic Code 39 is a variant of Code 39 used in marking computer tape cartridges. Trioptic Code 39 symbols always contain six characters. Do not enable Trioptic Code 39 and Code 39 Full ASCII simultaneously.

To enable or disable Trioptic Code 39, scan the appropriate bar code below.



**Enable Trioptic Code 39**  
(01h)



**\*Disable Trioptic Code 39**  
(00h)

## Convert Code 39 to Code 32

### Parameter # 56h

Code 32 is a variant of Code 39 used by the Italian pharmaceutical industry. Scan the appropriate bar code below to enable or disable converting Code 39 to Code 32.



**Convert Code 39 To Code 32  
(Enable)  
(01h)**



**NOTE** Code 39 must be enabled for this parameter to function.



**\*Do Not Convert Code 39 To Code 32  
(Disable)  
(00h)**

## Code 32 Prefix

### Parameter # E7h

Enable this parameter to add the prefix character "A" to all Code 32 bar codes. *Convert Code 39 to Code 32* must be enabled for this parameter to function.

- ✓ **NOTE** Disable Code 32 Prefix is the default for MS954. Enable Code 32 Prefix is the default for MS1204FZY, MS2204, MS2204VHD, MS3204.



**Enable Code 32 Prefix  
(01h)**



**Disable Code 32 Prefix  
(00h)**

## Set Lengths for Code 39

### Parameter # L1 = 12h, L2 = 13h

The length of a code refers to the number of characters (i.e., human readable characters), including check digit(s) the code contains. Set lengths for Code 39 to any length, one or two discrete lengths, or lengths within a specific range. If you enabled Code 39 Full ASCII, the recommended options are **Length Within a Range** or **Any Length**.

**One Discrete Length** - Select this option to decode only Code 39 symbols containing a selected length. Select the length using from the numeric bar codes beginning on [page 10-135](#). For example, to decode only Code 39 symbols with 14 characters, scan **Code 39 - One Discrete Length**, then scan **1** followed by **4**. To change the selection or cancel an incorrect entry, scan the *Cancel* bar code on [page 10-137](#).



**Code 39 - One Discrete Length**

**Two Discrete Lengths** - Select this option to decode only Code 39 symbols containing either of two selected lengths. Select lengths using the numeric bar codes beginning on [page 10-135](#). For example, to decode only Code 39 symbols containing either 2 or 14 characters, select **Code 39 - Two Discrete Lengths**, then scan **0**, **2**, **1**, and **4**. To change the selection or cancel an incorrect entry, scan the *Cancel* bar code on [page 10-137](#).

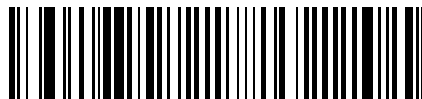

**Code 39 - Two Discrete Lengths**

**Length Within Range** - Select this option to decode only Code 39 symbols within a specified range. Select lengths using the numeric bar codes beginning on [page 10-135](#). For example, to decode Code 39 symbols containing between 4 and 12 characters, first scan **Code 39 Length Within Range**. Then scan **0**, **4**, **1**, and **2** (enter a leading zero for single digit numbers). To change the selection or cancel an incorrect entry, scan the *Cancel* bar code on [page 10-137](#).



**\*Code 39 - Length Within Range**

**Any Length** - Scan this option to decode Code 39 symbols containing any number of characters.



**Code 39 - Any Length**

## Code 39 Check Digit Verification

### Parameter # 30h

Enable this feature to check the integrity of all Code 39 symbols to verify that the data complies with specified check digit algorithm. The scanner decodes only Code 39 symbols which include a modulo 43 check digit.

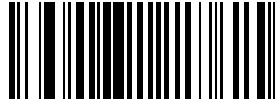

**Enable Code 39 Check Digit**  
(01h)

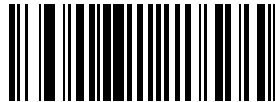

**\*Disable Code 39 Check Digit**  
(00h)

## Transmit Code 39 Check Digit

### Parameter # 2Bh

Scan this symbol to transmit the check digit with the data.



**Transmit Code 39 Check Digit**  
(Enable)  
(01h)

Scan this symbol to transmit data without the check digit.



**\*Do Not Transmit Code 39 Check Digit**  
(Disable)  
(00h)



## Enable/Disable Code 39 Full ASCII

### Parameter # 11h

To enable or disable Code 39 Full ASCII, scan the appropriate bar code below.

If you enable this, the ASCII character set assigns a code to letters, punctuation marks, numerals, and most control keystrokes on the keyboard.

The first 32 codes are non-printable and are assigned to keyboard control characters such as BACKSPACE and RETURN. The other 96 are printable codes because all except SPACE and DELETE produce visible characters.

Code 39 Full ASCII interprets the bar code special character (\$ + % /) preceding a Code 39 character and assigns an ASCII character value to the pair. For example, if you enable Code 39 Full ASCII and scan a **+B**, it transmits as **b**, **%J** as **?**, and **\$H** emulates the keystroke **BACKSPACE**. Scanning **ABC\$M** outputs the keystroke equivalent of **ABC ENTER**.

Do not enable Code 39 Full ASCII and Trioptic Code 39 simultaneously.

The scanner does not autodiscriminate between Code 39 and Code 39 Full ASCII.



**Enable Code 39 Full ASCII**  
(01h)



**\*Disable Code 39 Full ASCII**  
(00h)

## Code 39 Decode Performance

### Parameter # 46h

✓ **NOTE** Only the MS2204, MS2204VHD, and MS3204 support this option.

This option offers three levels of decode performance or “aggressiveness” for Code 39 symbols. Increasing the performance level reduces the amount of required bar code orientation, which is useful when scanning very long and/or truncated bar codes. Increased levels reduce decode security.

If you enable this option, you can select a Decode Performance level from the next page to suit performance needs.

✓ **NOTE** This option only works with Code 39 One Discrete Length.

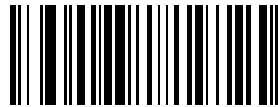

**\*Enable Code 39 Decode Performance  
(01h)**

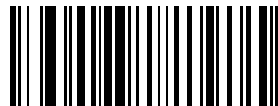

**Disable Code 39 Decode Performance  
(00h)**

## Code 39 Decode Performance Level

### Parameter # 47h

✓ **NOTE** Only the MS2204, MS2204VHD, and MS3204 support this option

Select a level of decode performance.

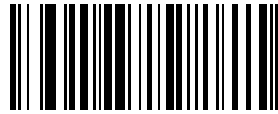

Code 39 Decode Performance Level 1  
(03h)

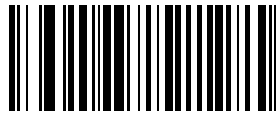

Code 39 Decode Performance Level 2  
(02h)



\*Code 39 Decode Performance Level 3  
(01h)

---

## Code 93

### Enable/Disable Code 93

#### Parameter # 09h

To enable or disable Code 93, scan the appropriate bar code below.



**Enable Code 93  
(01h)**



**\*Disable Code 93  
(00h)**

## Set Lengths for Code 93

### Parameter # L1 = 1Ah, L2 = 1Bh

The length of a code refers to the number of characters (i.e., human readable characters), including check digit(s) the code contains. Set lengths for Code 93 to any length, one or two discrete lengths, or lengths within a specific range.

**One Discrete Length** - Select this option to decode only codes containing a selected length. For example, select **Code 93 One Discrete Length**, then scan **1, 4** using the numeric bar codes that begin on [page 10-135](#), to decode only Code 93 symbols containing 14 characters. To change the selection or cancel an incorrect entry, scan the [Cancel](#) bar code on [page 10-137](#).



**Code 93 - One Discrete Length**

**Two Discrete Lengths** - Select this option to decode only codes containing two selected lengths. For example, select **Code 93 Two Discrete Lengths**, then scan **0, 2, 1, 4** using the numeric bar codes that begin on [page 10-135](#), to decode only Code 93 symbols containing 2 or 14 characters. To change the selection or cancel an incorrect entry, scan the [Cancel](#) bar code on [page 10-137](#).



**Code 93 - Two Discrete Lengths**

**Length Within Range** - Select this option to decode only codes within a specified range. For example, to decode Code 93 symbols containing between 4 and 12 characters, first scan **Code 93 Length Within Range**, then scan **0, 4, 1** and **2** (enter a leading zero for single digit numbers) using the numeric bar codes that begin on [page 10-135](#). To change the selection or cancel an incorrect entry, scan the [Cancel](#) bar code on [page 10-137](#).



**\*Code 93 - Length Within Range**

**Any Length** - Scan this option to decode Code 93 symbols containing any number of characters.



**Code 93 - Any Length**

---

## Code 11

### Enable/Disable Code 11

#### Parameter # 0Ah

To enable or disable Code 11, scan the appropriate bar code below.



**Enable Code 11  
(01h)**

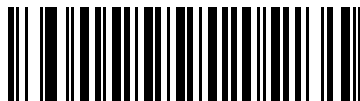

**\*Disable Code 11  
(00h)**

## Set Lengths for Code 11

### Parameter # L1 = 1Ch, L2 = 1Dh

The length of a code refers to the number of characters (i.e., human readable characters), including check digit(s) the code contains. Set lengths for Code 11 to any length, one or two discrete lengths, or lengths within a specific range.

**One Discrete Length** - Select this option to decode only codes containing a selected length. For example, select **Code 11 One Discrete Length**, then scan **1, 4** using the numeric bar codes that begin on [page 10-135](#) to decode only Code 11 symbols containing 14 characters. To change the selection or cancel an incorrect entry, scan the **Cancel** bar code on [page 10-137](#).

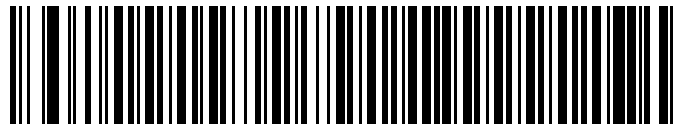

**Code 11 - One Discrete Length**

**Two Discrete Lengths** - Select this option to decode only codes containing two selected lengths. For example, select **Code 11 Two Discrete Lengths**, then scan **0, 2, 1, 4** using the numeric bar codes that begin on [page 10-135](#) to decode only Code 11 symbols containing 2 or 14 characters. To change the selection or cancel an incorrect entry, scan the **Cancel** bar code on [page 10-137](#).

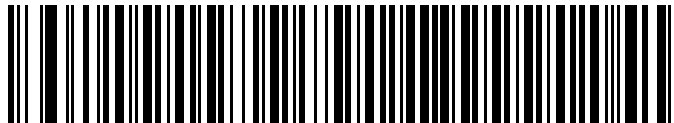

**Code 11 - Two Discrete Lengths**

**Length Within Range** - Select this option to decode only codes within a specified range. For example, to decode Code 11 symbols containing between 4 and 12 characters, first scan **Code 11 Length Within Range**, then scan **0, 4, 1** and **2** (enter a leading zero for single digit numbers) using the numeric bar codes that begin on [page 10-135](#). To change the selection or cancel an incorrect entry, scan the **Cancel** bar code on [page 10-137](#).



**\*Code 11 - Length Within Range**

**Any Length** - Scan this option to decode Code 11 symbols containing any number of characters.



**Code 11 - Any Length**

## Code 11 Check Digit Verification

### Parameter # 34h

Enable this parameter to check the integrity of a Code 11 symbol to ensure it complies with a specified check digit algorithm. Select either to check for one check digit, check for two check digits, or to disable the feature.



**\*Disable  
(00h)**

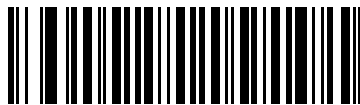

**One Check Digit  
(01h)**

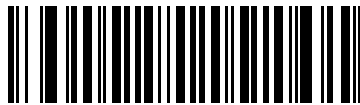

**Two Check Digits  
(02h)**



## Transmit Code 11 Check Digit

### Parameter # 2Fh

Scan this symbol to transmit the check digit with the data.

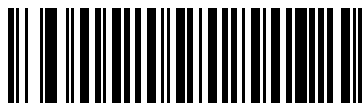

**Transmit Code 11 Check Digit  
(Enable)  
(01h)**

Scan this symbol to transmit data without the check digit.

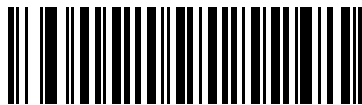

**\*Do Not Transmit Code 11 Check Digit  
(Disable)  
(00h)**

---

## Interleaved 2 of 5

### Enable/Disable Interleaved 2 of 5

#### Parameter # 06h

To enable or disable Interleaved 2 of 5, scan the appropriate bar code below.

- ✓ **NOTE** **Disable Interleaved 2 of 5** is the default for MS954. **Enable Interleaved 2 of 5** is the default for the MS1204FZY, MS2204, MS2204VHD, and MS3204

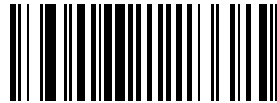

**Enable Interleaved 2 of 5  
(01h)**

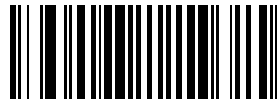

**Disable Interleaved 2 of 5  
(00h)**

## Set Lengths for Interleaved 2 of 5

### Parameter # L1 = 16h, L2 = 17h

The length of a code refers to the number of characters (i.e., human readable characters) the code contains, and includes check digits. Set lengths for I 2 of 5 for any length, one or two discrete lengths, or lengths within a specific range.

**One Discrete Length** - Select this option to decode only codes containing a selected length. For example, select **I 2 of 5 One Discrete Length**, then scan **1, 4** using the numeric bar codes that begin on [page 10-135](#) to decode only I 2 of 5 symbols containing 14 characters. To change the selection or cancel an incorrect entry, scan the **Cancel** bar code on [page 10-137](#).



**\*I 2 of 5 - One Discrete Length**

**Two Discrete Lengths** - Select this option to decode only codes containing two selected lengths. For example, select **I 2 of 5 Two Discrete Lengths**, then scan **0, 2, 1, 4** using the numeric bar codes that begin on [page 10-135](#) to decode only I 2 of 5 symbols containing 2 or 14 characters. To change the selection or cancel an incorrect entry, scan the **Cancel** bar code on [page 10-137](#).



**I 2 of 5 - Two Discrete Lengths**

**Length Within Range** - Select this option to decode only codes within a specified range. For example, to decode I 2 of 5 symbols containing between 4 and 12 characters, first scan **I 2 of 5 Length Within Range**, then scan **0, 4, 1** and **2** (enter a leading zero for single digit numbers) using the numeric bar codes that begin on [page 10-135](#). To change the selection or cancel an incorrect entry, scan the **Cancel** bar code on [page 10-137](#).



**I 2 of 5 - Length Within Range**

**Any Length** - Scan this option to decode I 2 of 5 symbols containing any number of characters.



**NOTE** Selecting this option can lead to misdecodes for I 2 of 5 codes.



**I 2 of 5 - Any Length**

## I 2 of 5 Check Digit Verification

### Parameter # 31h

Enabled this parameter to check the integrity of an I 2 of 5 symbol to ensure it complies with a specified algorithm, either USS (Uniform Symbology Specification), or OPCC (Optical Product Code Council).



**\*Disable  
(00h)**



**USS Check Digit  
(01h)**



**OPCC Check Digit  
(02h)**

## Transmit I 2 of 5 Check Digit

### Parameter # 2Ch

Scan this symbol to transmit the check digit with the data.



**Transmit I 2 of 5 Check Digit  
(Enable)  
(01h)**

Scan this symbol to transmit data without the check digit.



**\*Do Not Transmit I 2 of 5 Check Digit  
(Disable)  
(00h)**

## Convert I 2 of 5 to EAN-13

### Parameter # 52h

This parameter converts a 14 character I 2 of 5 code into EAN-13, and transmits to the host as EAN-13. To accomplish this, I 2 of 5 must be enabled, one length must be set to 14, and the code must have a leading zero and a valid EAN-13 check digit.



**Convert I 2 of 5 to EAN-13  
(Enable)  
(01h)**



**\*Do Not Convert I 2 of 5 to EAN-13  
(Disable)  
(00h)**

---

## Discrete 2 of 5

### Enable/Disable Discrete 2 of 5

#### Parameter # 05h

To enable or disable Discrete 2 of 5, scan the appropriate bar code below.



Enable Discrete 2 of 5  
(01h)



\*Disable Discrete 2 of 5  
(00h)

## Set Lengths for Discrete 2 of 5

### Parameter # L1 = 14h, L2 = 15h

The length of a code refers to the number of characters (i.e., human readable characters) the code contains, and includes check digits. Set lengths for D 2 of 5 to any length, one or two discrete lengths, or lengths within a specific range.

**One Discrete Length** - Select this option to decode only codes containing a selected length. For example, select **D 2 of 5 One Discrete Length**, then scan **1, 4** using the numeric bar codes that begin on [page 10-135](#) to decode only D 2 of 5 symbols containing 14 characters. To change the selection or cancel an incorrect entry, scan the *Cancel* bar code on [page 10-137](#).



**\*D 2 of 5 - One Discrete Length**

**Two Discrete Lengths** - Select this option to decode only codes containing two selected lengths. For example, select **D 2 of 5 Two Discrete Lengths**, then scan **0, 2, 1, 4** using the numeric bar codes that begin on [page 10-135](#) to decode only D 2 of 5 symbols containing 2 or 14 characters. To change the selection or cancel an incorrect entry, scan the *Cancel* bar code on [page 10-137](#).



**D 2 of 5 - Two Discrete Lengths**

**Length Within Range** - Select this option to decode codes within a specified range. For example, to decode D 2 of 5 symbols containing between 4 and 12 characters, first scan **D 2 of 5 Length Within Range**, then scan **0, 4, 1** and **2** (enter a leading zero for single digit numbers) using the numeric bar codes that begin on [page 10-135](#). To change the selection or cancel an incorrect entry, scan the *Cancel* bar code on [page 10-137](#).



**D 2 of 5 - Length Within Range**

**Any Length** - Scan this option to decode D 2 of 5 symbols containing any number of characters.



**NOTE** Selecting this option can lead to misdecodes for D 2 of 5 codes.



**D 2 of 5 - Any Length**

---

## Chinese 2 of 5

### Enable/Disable Chinese 2 of 5

#### Parameter # 0xF0 0x98

To enable or disable Chinese 2 of 5, scan the appropriate bar code below.



Enable Chinese 2 of 5  
(0x01)



\*Disable Chinese 2 of 5  
(0x00)

\



**NOTE** Chinese 2 of 5 is supported by the MS954 only.



---

## Korean 3 of 5

✓ **NOTE** Only the MS954 (manufactured on/after July 1, 2014) supports this option.

### Enable/Disable Korean 3 of 5

#### Parameter # F1h 45h

To enable or disable Korean 3 of 5, scan the appropriate bar code below.

✓ **NOTE** The length for Korean 3 of 5 is fixed at 6.



Enable Korean 3 of 5  
(01h)



\*Disable Korean 3 of 5  
(00h)

---

## Chinese 2 of 5

### Enable/Disable Chinese 2 of 5

#### Parameter # F0h 98h

To enable or disable Chinese 2 of 5, scan the appropriate bar code below.

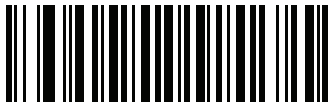

Enable Chinese 2 of 5  
(01h)

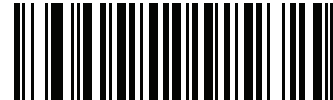

\*Disable Chinese 2 of 5  
(00h)

---

## Matrix 2 of 5

✓ **NOTE** Only the MS954 (manufactured on/after July 1, 2014) supports this option.

### Enable/Disable Matrix 2 of 5

#### Parameter # F1h 6Ah

To enable or disable Matrix 2 of 5, scan the appropriate bar code below.



Enable Matrix 2 of 5  
(01h)



\*Disable Matrix 2 of 5  
(00h)

## Set Lengths for Matrix 2 of 5.

✓ **NOTE** Only the MS954 (manufactured on/after July 1, 2014) supports this option.

### Parameter # L1 = F1h 6Bh, L2 = F1h 6Ch

The length of a code refers to the number of characters (i.e., human readable characters), including check digit(s) the code contains. Set lengths for Matrix 2 of 5 to any length, one or two discrete lengths, or lengths within a specific range.

- **One Discrete Length** - Select this option to decode only Matrix 2 of 5 symbols containing a selected length. Select the length using the [Numeric Bar Codes on page 10-135](#). For example, to decode only Matrix 2 of 5 symbols with 14 characters, scan **Matrix 2 of 5 - One Discrete Length**, then scan **1** followed by **4**. To correct an error or to change the selection, scan [Cancel on page 10-137](#).
- **Two Discrete Lengths** - Select this option to decode only Matrix 2 of 5 symbols containing either of two selected lengths. Select lengths using the [Numeric Bar Codes on page 10-135](#). For example, to decode only Matrix 2 of 5 symbols containing either 2 or 14 characters, select **Matrix 2 of 5 - Two Discrete Lengths**, then scan **0**, **2**, **1**, and then **4**. To correct an error or to change the selection, scan [Cancel on page 10-137](#).
- **Length Within Range** - Select this option to decode a Matrix 2 of 5 symbol with a specific length range. Select lengths using the [Numeric Bar Codes on page 10-135](#). For example, to decode Matrix 2 of 5 symbols containing between 4 and 12 characters, first scan **Matrix 2 of 5 - Length Within Range**. Then scan **0**, **4**, **1**, and **2** (enter a leading zero for single digit numbers). To correct an error or change the selection, scan [Cancel on page 10-137](#).

- **Any Length** - Scan this option to decode Matrix 2 of 5 symbols containing any number of characters within the digital scanner's capability.



\*Matrix 2 of 5 - One Discrete Length



Matrix 2 of 5 - Two Discrete Lengths

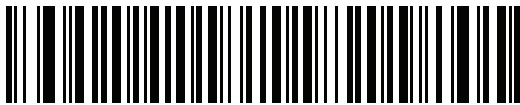

Matrix 2 of 5 - Length Within Range



Matrix 2 of 5 - Any Length

## Matrix 2 of 5 Check Digit

✓ **NOTE** Only the MS954 (manufactured on/after July 1, 2014) supports this option.

### Parameter # F1h 6Eh

The check digit is the last character of the symbol used to verify the integrity of the data. Scan the appropriate bar code below to transmit the bar code data with or without the Matrix 2 of 5 check digit.



Enable Matrix 2 of 5 Check Digit  
(01h)



\*Disable Matrix 2 of 5 Check Digit  
(00h)

## Transmit Matrix 2 of 5 Check Digit

✓ **NOTE** Only the MS954 (manufactured on/after July 1, 2014) supports this option.

### Parameter # F1h 6Fh

Scan a bar code below to transmit Matrix 2 of 5 data with or without the check digit.



Transmit Matrix 2 of 5 Check Digit  
(01h)



\*Do Not Transmit Matrix 2 of 5 Check Digit  
(00h)

---

## Codabar

### Enable/Disable Codabar

#### Parameter # 07h

To enable or disable Codabar, scan the appropriate bar code below.



**Enable Codabar  
(01h)**

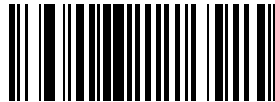

**\*Disable Codabar  
(00h)**

## Set Lengths for Codabar

### Parameter # L1 = 18h, L2 = 19h

The length of a code refers to the number of characters (i.e., human readable characters) the code contains, including start or stop characters. Set lengths for Codabar to any length, one or two discrete lengths, or lengths within a specific range.

**One Discrete Length** - Select this option to decode only codes containing a selected length. For example, select **Codabar One Discrete Length**, then scan **1, 4** using the numeric bar codes that begin on [page 10-135](#), to decode only Codabar symbols containing 14 characters. To change the selection or cancel an incorrect entry, scan the **Cancel** bar code on [page 10-137](#).



**Codabar - One Discrete Length**

**Two Discrete Lengths** - Select this option to decode only codes containing two selected lengths. For example, select **Codabar Two Discrete Lengths**, then scan **0, 2, 1, 4** using the numeric bar codes that begin on [page 10-135](#), to decode only Codabar symbols containing 2 or 14 characters. To change the selection or cancel an incorrect entry, scan the **Cancel** bar code on [page 10-137](#).



**Codabar - Two Discrete Lengths**

**Length Within Range** - Select this option to decode a code within a specified range. For example, to decode Codabar symbols containing between 4 and 12 characters, first scan **Codabar Length Within Range**, then scan **0, 4, 1** and **2** (enter a leading zero for single digit numbers) using the numeric bar codes that begin on [page 10-135](#). To change the selection or cancel an incorrect entry, scan the **Cancel** bar code on [page 10-137](#).



**\*Codabar - Length Within Range**

**Any Length** - Scan this option to decode Codabar symbols containing any number of characters.



**Codabar - Any Length**

## CLSI Editing

### Parameter # 36h

Enable this parameter to strip the start and stop characters and insert a space after the first, fifth, and tenth characters of a 14-character Codabar symbol.

✓ **NOTE** Symbol length does not include start and stop characters.

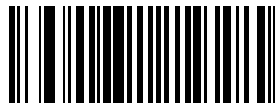

Enable CLSI Editing  
(01h)

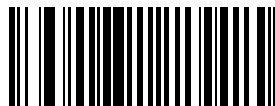

\*Disable CLSI Editing  
(00h)

## NOTIS Editing

### Parameter # 37h

Enable this parameter to strip the start and stop characters from decoded Codabar symbol.

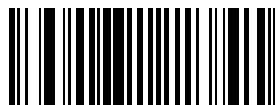

Enable NOTIS Editing  
(01h)

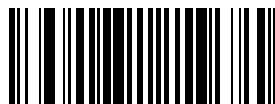

\*Disable NOTIS Editing  
(00h)



## Codabar Upper or Lower Case Start/Stop Characters Detection

Parameter # # F2h 57h

✓ **NOTE** Only the MS954 (manufactured on/after July 1, 2014) supports this option.

Select whether to detect upper case or lower case Codabar start/stop characters.

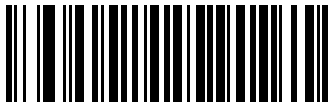

**\*Lower Case  
(01h)**



**Upper Case  
(00h)**

---

## MSI Plessey

### Enable/Disable MSI Plessey

#### Parameter # 0Bh

To enable or disable MSI Plessey, scan the appropriate bar code below.



**Enable MSI Plessey  
(01h)**



**\*Disable MSI Plessey  
(00h)**

## Set Lengths for MSI Plessey

### Parameter # L1 = 1Eh, L2 = 1Fh

The length of a code refers to the number of characters (i.e., human readable characters) the code contains, and includes check digits. Set lengths for MSI Plessey to any length, one or two discrete lengths, or lengths within a specific range.

**One Discrete Length** - Select this option to decode only codes containing a selected length. For example, select **MSI Plessey One Discrete Length**, then scan **1, 4** using the numeric bar codes that begin on [page 10-135](#) to decode only MSI Plessey symbols containing 14 characters. To change the selection or cancel an incorrect entry, scan the [Cancel](#) bar code on [page 10-137](#).



**MSI Plessey - One Discrete Length**

**Two Discrete Lengths** - Select this option to decode only those codes containing two selected lengths. For example, select **MSI Plessey Two Discrete Lengths**, then scan **0, 2, 1, 4** using the numeric bar codes that begin on [page 10-135](#) to decode only MSI Plessey symbols containing 2 or 14 characters. To change the selection or cancel an incorrect entry, scan the [Cancel](#) bar code on [page 10-137](#).



**MSI Plessey - Two Discrete Lengths**

**Length Within Range** - Select this option to decode codes within a specified range. For example, to decode MSI Plessey symbols containing between 4 and 12 characters, first scan **MSI Plessey Length Within Range**, then scan **0, 4, 1** and **2** (enter a leading zero for single digit numbers) using the numeric bar codes that begin on [page 10-135](#). To change the selection or cancel an incorrect entry, scan the [Cancel](#) bar code on [page 10-137](#).



**\*MSI Plessey - Length Within Range**

**Any Length** - Scan this option to decode MSI Plessey symbols containing any number of characters.



**NOTE** Selecting this option can lead to misdecodes for MSI Plessey codes.



**MSI Plessey - Any Length**

## MSI Plessey Check Digits

### Parameter # 32h

These check digits at the end of the bar code verify the integrity of the data. At least one check digit is required. Check digits are not automatically transmitted with the data.



**\*One MSI Plessey Check Digit  
(00h)**

If you select two check digits, also select an [MSI Plessey Check Digit Algorithm on page 10-97](#).



**Two MSI Plessey Check Digit  
(01h)**

## Transmit MSI Plessey Check Digit

### Parameter # 2Eh

Scan this symbol to transmit the check digit with the data.



**Transmit MSI Plessey Check Digit  
(Enable)  
(01h)**

Scan this symbol to transmit data without the check digit.



**\*Do Not Transmit MSI Plessey Check Digit  
(Disable)  
(00h)**

## MSI Plessey Check Digit Algorithm

### Parameter # 33h

If you selected the Two MSI Plessey check digits option, an additional verification is required to ensure integrity. Select one of the following algorithms.



**MOD 10/ MOD 11  
(00h)**



**\*MOD 10/ MOD 10  
(01h)**

---

## PDF417/MicroPDF417

✓ **NOTE** Only the MS2204, MS2204VHD, and MS3204 support this option.

### Enable/Disable PDF417

#### Parameter # 0Fh

To enable or disable PDF417, scan the appropriate bar code below.



**Enable PDF417  
(01h)**



**Disable PDF417  
(00h)**

### Enable/Disable MicroPDF417

#### Parameter # E3h

To enable or disable MicroPDF417, scan the appropriate bar code below.



**Enable MicroPDF417  
(01h)**



**\*Disable MicroPDF417  
(00h)**

## MicroPDF Performance

### Parameter # F0h 65h

If the scanner is having trouble decoding MicroPDF symbols, select Selective Performance. Note that this can decrease decoding aggressiveness on some symbols.



**\*Standard Performance for MicroPDF**



**Selective Performance for MicroPDF**

## Code 128 Emulation

### Parameter # 7Bh

Enable this parameter to transmit data from certain MicroPDF417 symbols as if it was encoded in Code 128 symbols. Transmit AIM Symbology Identifiers must be enabled for this parameter to work.

Enable Code 128 Emulation to transmit these MicroPDF417 symbols with one of the following prefixes:

]C1 if the first codeword is 903-907, 912, 914, 915

]C2 if the first codeword is 908 or 909

]C0 if the first codeword is 910 or 911

Disable Code 128 Emulation to transmit these MicroPDF417 symbols with one of the following prefixes:

]L3 if the first codeword is 903-907, 912, 914, 915

]L4 if the first codeword is 908 or 909

]L5 if the first codeword is 910 or 911

Scan a bar code below to enable or disable Code 128 Emulation.



**Enable Code 128 Emulation  
(01h)**



**\*Disable Code 128 Emulation  
(00h)**



---

## GS1 DataBar

### GS1 DataBar-14

#### Parameter # F0h 52h

To enable or disable GS1 DataBar-14, scan the appropriate bar code below.

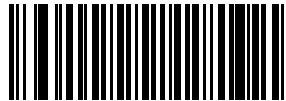

Enable GS1 DataBar-14  
(01h)

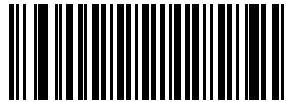

\*Disable GS1 DataBar-14  
(00h)

### GS1 DataBar Limited

#### Parameter # F0h 53h

To enable or disable GS1 DataBar Limited, scan the appropriate bar code below.



Enable GS1 DataBar Limited  
(01h)

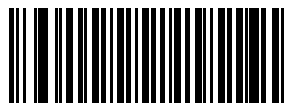

\*Disable GS1 DataBar Limited  
(00h)

## GS1 DataBar Expanded

### Parameter # F0h 54h

To enable or disable GS1 DataBar Expanded, scan the appropriate bar code below.



**Enable GS1 DataBar Expanded  
(01h)**

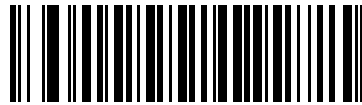

**\*Disable GS1 DataBar Expanded  
(00h)**

### GS1 DataBar Limited Security Level

✓ **NOTE** Only the MS954 (manufactured on/after July 1, 2014) supports this option.

#### Parameter # F1h D8h

The digital scanner offers four levels of decode security for GS1 DataBar Limited bar codes. There is an inverse relationship between security and digital scanner aggressiveness. Increasing the level of security may result in reduced aggressiveness in scanning, so only choose the level of security necessary.

- Level 1 – No clear margin required. This complies with the original GS1 standard, yet might result in erroneous<sup>1</sup> decoding of the DataBar Limited bar code when scanning some UPC symbols that start with the digits “9” and “7”.
- Level 2 – Automatic risk detection. This level of security may result in erroneous decoding of DataBar Limited bar codes when scanning some UPC symbols. If a misdecode is detected, the scanner operates in Level 3 or Level 1.
- Level 3 – Security level reflects newly proposed GS1 standard that requires a 5X trailing clear margin.
- Level 4 – Security level extends beyond the standard required by GS1. This level of security requires a 5X leading and trailing clear margin.



Security Level 1  
(01h)



Security Level 2  
(02h)



\*Security Level 3  
(03h)



Security Level 4  
(04h)

---

1. May result in erroneous decoding due to Databar Limited and UPC symbologies.

## Convert GS1 DataBar to UPC/EAN

### Parameter # F0h 8Dh

✓ **NOTE** Only the MS1204FZY supports this option.

This parameter only applies to GS1 DataBar-14 and GS1 DataBar Limited symbols not decoded as part of a Composite symbol. Enable this conversion to strip the leading '010' from GS1 DataBar-14 and GS1 DataBar Limited symbols encoding a single zero as the first digit, and report the bar code as EAN-13.

For bar codes beginning with two or more zeros but not six zeros, this strips the leading '0100' and reports the bar code as UPC-A. The UPC-A Preamble parameter to transmit the system character and country code applies to converted bar codes. Note that neither the system character nor the check digit can be stripped.



**Enable Convert GS1 DataBar to UPC/EAN  
(01h)**



**\*Disable Convert GS1 DataBar to UPC/EAN  
(00h)**

---

## Composite

✓ **NOTE** Only the MS2204, MS2204VHD, and MS3204 support this option.

### Composite CC-C

#### Parameter # F0h 55h

Scan a bar code below to enable or disable Composite bar codes of type CC-C.



**Enable CC-C  
(01h)**



**\*Disable CC-C  
(00h)**

## Composite CC-A/B

### Parameter # F0h 56h

Scan a bar code below to enable or disable Composite bar codes of type CC-A/B.

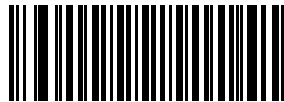

Enable CC-A/B  
(01h)

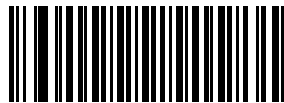

\*Disable CC-A/B  
(00h)

## Composite TLC-39

### Parameter # F0h 73h

Scan a bar code below to enable or disable Composite bar codes of type TLC-39.

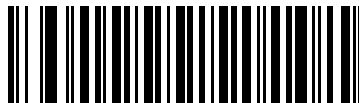

Enable TLC39  
(01h)



\*Disable TLC39  
(00h)

## UPC Composite Mode

### Parameter # F0h 58h

Select an option to link UPC symbols with a 2D symbol during transmission as if they were one symbol:

- Select **UPC Never Linked** to transmit UPC bar codes regardless of whether the scanner detects a 2D symbol.
- Select **UPC Always Linked** to transmit UPC bar codes and the 2D portion. If 2D is not present, the UPC bar code does not transmit.
- If you select **Autodiscriminate UPC Composites**, the scanner determines if there is a 2D portion, then transmits the UPC, as well as the 2D portion if present.

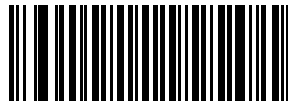

**UPC Never Linked  
(00h)**



**\*UPC Always Linked  
(01h)**

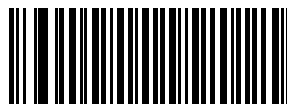

**Autodiscriminate UPC Composites  
(02h)**

## Data Options

### Transmit Code ID Character

#### Parameter # 2Dh

A code ID character identifies the code type of a scanned bar code. This can be useful when decoding more than one code type. The code ID character is inserted between the prefix character (if selected) and the decoded symbol.

Select no code ID character, a Symbol Code ID character, or an AIM Code ID character. The Symbol Code ID characters are listed below.

**Table 10-1** *Symbol Code ID Characters*

Code Type	Symbol Identifier
UPC-A, UPC-E, UPC-E1, EAN-13, EAN-8	A
Code 39, Code 32	B
Codabar	C
Code 128, ISBT 128	D
Code 93	E
Interleaved 2 of 5	F
Discrete 2 of 5, D 2of 5 IATA	G
Code 11	H
MSI Plessey	J
GS1-128	K
Bookland EAN	L
Trioptic Code 39	M
Coupon Code	N
GS1 DataBar (all variants)	R
Composite*	T
Scanlet	W

**\*Note: UPC/EAN Composite transmits in two portions, each with a "T" prefix.**



**Transmit Code ID Character (continued)**

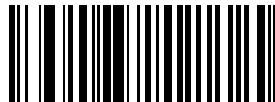

**Symbol Code ID Character  
(02h)**

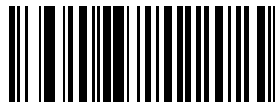

**AIM Code ID Character  
(01h)**



**\*None  
(00h)**

## Prefix/Suffix Values

### Parameter # P = 69h, S1 = 68h, S2 = 6Ah

You can append a prefix and/or one or two suffixes to scan data for use in data editing. To set a value for a prefix or suffix, scan a four-digit number (i.e., four bar codes from [Numeric Bar Codes on page 10-135](#)) that corresponds to that value. See [Table A-1 on page A-1](#) for the four-digit codes.

To change the selection or cancel an incorrect entry, scan the [Cancel](#) bar code on [page 10-137](#).

✓ **NOTE** In order to use Prefix/Suffix values, first set the [Scan Data Transmission Format on page 10-111](#).

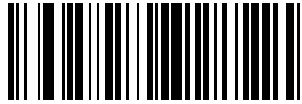

Scan Prefix  
(07h)

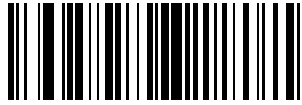

Scan Suffix 1  
(06h)



Scan Suffix 2  
(08h)

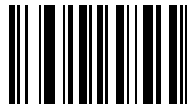

Data Format Cancel

## Scan Data Transmission Format

### Parameter # EBh

To change the scan data format, scan one of the following eight bar codes corresponding to the desired format.

✓ **NOTE** To set values for the prefix and/or suffix, see [Prefix/Suffix Values on page 10-110](#).



\*Data As Is  
(00h)



<DATA> <SUFFIX 1>  
(01h)



<DATA> <SUFFIX 2>  
(02h)



<DATA> <SUFFIX 1> <SUFFIX 2>  
(03h)

## Scan Data Transmission Format (continued)



<PREFIX> <DATA>  
(04h)



<PREFIX> <DATA> <SUFFIX 1>  
(05h)



<PREFIX> <DATA> <SUFFIX 2>  
(06h)



<PREFIX> <DATA> <SUFFIX 1> <SUFFIX 2>  
(07h)

---

## Simple Serial Interface (SSI) Options

### Baud Rate

#### Parameter # 9Ch

✓ **NOTE** To set the baud rate for MS954 devices manufactured after July 1, 2014 see [10-115](#).

Baud rate is the number of bits of data that transmit per second. Set the scanner's baud rate setting to match the data rate setting of the host. If not, data may not reach the host device or may reach it in distorted form.



**Baud Rate 300  
(01h)**



**Baud Rate 600  
(02h)**



**Baud Rate 1200  
(03h)**



**Baud Rate 2400  
(04h)**

**Baud Rate (continued)**

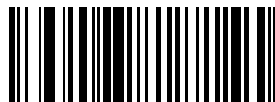

**Baud Rate 4800  
(05h)**



**\*Baud Rate 9600  
(06h)**



**Baud Rate 19,200  
(07h)**



**38,400  
(08h)**

**Baud Rate - For MS954 Devices Manufactured After July 1, 2014**

Scan a baud rate below to set the baud rate for MS954 devices manufactured after July 1, 2014.



**Baud Rate 1200  
(03h)**



**Baud Rate 2400  
(04h)**



**Baud Rate 4800  
(05h)**



**\*Baud Rate 9600  
(06h)**



**Baud Rate 19,200  
(07h)**

**Baud Rate (continued)**



**Baud Rate 38,400  
(08h)**



**Baud Rate 57,600  
(0Ah)**



**Baud Rate 115,200  
(0Bh)**



## Parity

### Parameter # 9Eh

A parity check bit is the most significant bit of each ASCII coded character. Select the parity type according to host device requirements.

If you select **Odd** parity, the parity bit has a value 0 or 1, based on data, to ensure that the coded character contains an odd number of 1 bits.

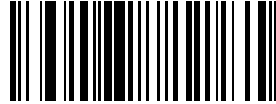

**Odd**  
**(00h)**

If you select **Even** parity, the parity bit has a value 0 or 1, based on data, to ensure that the coded character contains an even number of 1 bits.

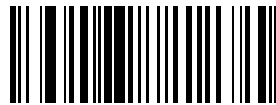

**Even**  
**(01h)**

Select **Mark** parity and the parity bit is always 1.

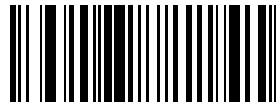

**Mark**  
**(02h)**

Select **Space** parity and the parity bit is always 0.



**Space**  
**(03h)**

If no parity is required, select **None**.



**\*None**  
**(04h)**

## Check Parity

### Parameter # 97h

✓ **NOTE** The default is **Check Parity** for the MS1204FZY, MS2204, MS2204VHD, and MS3204. The default for the MS954 is **Do Not Check Parity**.

Select whether or not to check the parity of received characters. Select the type of parity through the *Parity* parameter.



**Check Parity  
(01h)**



**Do Not Check Parity  
(00h)**

## Software Handshaking

### Parameter # 9Fh

This parameter offers control of data transmission in addition to that offered by hardware handshaking. Hardware handshaking is always enabled and cannot be disabled by the user.

#### Disable ACK/NAK Handshaking

If you select this option, the decoder neither generates nor expects ACK/NAK handshaking packets.



**Disable ACK/NAK**

**(00h)**

#### Enable ACK/NAK Handshaking

If you select this option, after transmitting data, the scanner expects either an ACK or NAK response from the host. The scanner also ACKs or NAKs messages from the host.

The scanner waits up to the programmable Host Serial Response Time-out to receive an ACK or NAK. If the scanner does not get a response in this time, it resends its data up to two times before discarding the data and declaring a transmit error.

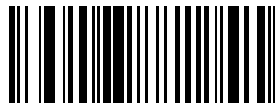

**\*Enable ACK/NAK**

**(01h)**

## Host RTS Line State

### Parameter # 9Ah

✓ **NOTE** Only the MS1204FZY, MS2204, MS2204VHD, and MS3204 support this option.

This parameter sets the idle state of the Serial Host RTS line.

The SSI Interface is for use with host applications which also implement the SSI protocol. However, you can use the scanner in a "scan-and-transmit" mode to communicate with any standard serial communications software on a host PC (see [Decode Data Packet Format on page 10-121](#)). If transmission errors occur in this mode, the host PC may be asserting hardware handshaking lines which interfere with the SSI protocol. Scan the **HOST: RTS HIGH** bar code to address this problem.



**\*Host: RTS Low  
(00h)**



**Host: RTS High  
(01h)**

## Decode Data Packet Format

### Parameter # EEh

This parameter selects whether to transmit decoded data in raw format (unpacketed), or with the packet format as defined by the serial protocol.

Selecting the raw format disables ACK/NAK handshaking for decode data.



**\*Send Raw Decode Data**  
(00h)



**Send Packeted Decode Data**  
(01h)

## Stop Bit Select

### Parameter # 9Dh

The stop bit(s) at the end of each transmitted character marks the end of transmission of one character and prepares the receiving (host) device for the next character in the serial data stream. Set the number of stop bits (one or two) to match host device requirements.



**\*1 Stop Bit**  
(01h)



**2 Stop Bits**  
(02h)

## Intercharacter Delay

### Parameter # 6Eh

The intercharacter delay gives the host system time to service its receiver and perform other tasks between characters. Select the intercharacter delay option matching host requirements. The delay period can range from no delay to 99 msec in 1 msec increments. After scanning the bar code below, scan two bar codes beginning on [page 10-135](#) to set the desired time-out. To change the selection or cancel an incorrect entry, scan the [Cancel](#) bar code on [page 10-137](#).



Intercharacter Delay

## Host Serial Response Time-out

### Parameter # 9Bh

This parameter specifies how long the decoder waits for an ACK or NAK before resending. Also, if the decoder wants to send, and the host was already granted permission to send, the decoder waits for the designated time-out before declaring an error.

The delay period can range from 0.0 to 9.9 seconds in 0.1 second increments. After scanning the bar code below, scan two numeric bar codes beginning on [page 10-135](#). Time durations of less than 1.0 second require a leading zero. To change the selection or cancel an incorrect entry, scan the [Cancel](#) bar code on [page 10-137](#).



Host Serial Response Time-out

## Host Character Time-out

### Parameter # EFh

This parameter determines the maximum time the decoder waits between characters transmitted by the host before discarding the received data and declaring an error. Set the time-out in 0.01 second increments from 0.01 seconds to 0.99 seconds. After scanning the bar code below, scan two bar codes beginning on [page 10-135](#) to set the time-out. To change the selection or cancel an incorrect entry, scan the [Cancel](#) bar code on [page 10-137](#).



Host Character Time-out

## Event Reporting

The host can request the decoder to provide certain information (events) relative to the decoder's behavior. Enable or disable the events listed in [Table 10-2](#) by scanning the appropriate bar codes on the following pages. For the parameter number format for these parameters, refer to the *Simple Serial Interface (SSI) Programmer's Guide* for parameters numbered 256 or higher.

**Table 10-2** *Event Codes*

Event Class	Event	Code Reported
Decode Event	Non parameter decode	01h
Boot Up Event	System power-up	03h
Parameter Event	Parameter entry error	07h
	Parameter stored	08h
	Defaults set (and parameter event is enabled by default)	0Ah
	Number expected	0Fh

### Decode Event

#### Parameter # F0h 00h

Enable this to send a message to the host upon a successful decoded. Disable this to send no message.



**Enable**  
**(01h)**



**\*Disable**  
**(00h)**

## Boot Up Event

### Parameter # F0h 02h

Enable this to send a message to the host when power is applied. Disable this to send no message.



Enable  
(01h)



\*Disable  
(00h)

## Parameter Event

### Parameter # F0h 03h

Enable this to send a message to the host when an event listed in [Table 10-2 on page 10-123](#) occurs. Disable this to send no message.



Enable  
(01h)



\*Disable  
(00h)



## Macro PDF Features



**NOTE** Only the MS2204, MS2204VHD, and MS3204 support this option.

### Transmit Symbols in Codeword Format

#### Parameter # Afh

Enable this to transmit each PDF symbol as directly decoded data codewords, whether or not that symbol is part of a macro PDF sequence. Note that data is output as codeword values, not as interpreted data.

“Codeword values” is an ASCII representation of a number from 000 to 928 for each codeword, preceded by an escape character. This escape character is a backslash by default, but you can change this value. For example, the codeword value 005 is sent to the host in the form of \005 for GLIs, and \C005C for ECIs. This output format is based on the AIM USA Uniform Symbology Specification for PDF417 (1994).

All output codewords are exactly 4 characters for GLIs and 6 characters for ECIs. However, there can be non-decodable characters in the PDF symbol, such as a GLI sequence. This special codeword sequence activates a certain kind of interpretation to the encoded data. Non-decodable codewords like GLIs are embedded in the output stream like any other codeword, e.g., \927\001.

Because GLIs are indistinguishable from other codewords in the output data stream, the host must recognize them as GLIs and process their interpretations.

Note that when a macro PDF sequence transmits, the last character in the last block of data transmitted is always \922 (if selected). This indicates the end of that macro PDF transmission.

Scan the appropriate bar code to enable or disable this.



**Enable Transmit In Codeword Format**

**(01h)**



**\*Disable Transmit In Codeword Format**

**(00h)**

## Transmit Unknown Codewords

### Parameter # BAh

Select **Transmit Unknown Codewords** to use the output codeword format for transmitting any non-GLI or non-macro PDF codeword. Select **Do Not Transmit Unknown Codewords** to sound a decode error beep when the scanner encounters an unknown codeword.



**Transmit Unknown Codewords**

**(01h)**



**\*Do Not Transmit Unknown Codewords**

**(00h)**

## Escape Characters

### Parameter # E9h

This enables the backslash (\) character as an Escape character for systems that can process transmissions containing special data sequences. Scan a bar code below to either format special data (e.g., GLI escapes, MacroPDF417 Control Block optional fields) according to the GLI (Global Label Identifier) protocol or the ECI (Extended Channel Interpretation) protocol, or to disable this parameter.



**ECI Protocol**  
(01h)



**GLI Protocol**  
(02h)



**\*None**  
(00h)

## Delete Character Set ECIs

### Parameter # E6h

✓ **NOTE** Only the MS2204, MS2204VHD, and MS3204 support this option.

Select **Delete Character Set ECIs** to delete any escape sequences representing Character Set ECIs (also known as GLIs) from its buffer before transmission. In many receiving systems, you can remove Character Set ECIs without affecting the way data is displayed or processed.

Select **Transmit Character Set ECIs** to transmit data from PDF417 and MicroPDF417 bar codes containing Character Set ECIs, even when the ECI Protocol is disabled.

Scan a bar code to delete or transmit character set ECIs.



**Delete Character Set ECIs**  
(01h)



**\*Transmit Character Set ECIs**  
(00h)

## ECI Decoder

### Parameter # E8h

✓ **NOTE** This option is supported by the MS2204, MS2204VHD and MS3204 only.

This parameter enables the scanner to interpret any Extended Channel Interpretations (ECIs) that are supported by the scanner firmware. This does not affect symbols not encoded using ECIs. This version of the product supports ECIs 000900 through 000913, used for efficient encoding of Common Data Syntax Format 00-99. If this parameter is disabled, and a symbol is scanned that was encoded using an ECI escape, the scanner transmits the ECI escape followed by the uninterpreted data.

Scan a bar code to enable or disable this option.



**\*Enable ECI Decoder  
(01h)**



**Disable ECI Decoder  
(00h)**

---

## Transmit Macro PDF User-Selected Fields

✓ **NOTE** Only the MS2204, MS2204VHD, and MS3204 support this option

Enable or disable each of the following parameters to indicate whether to transmit the specified field in subsequently scanned Macro PDF417 symbols. You cannot change these options in the middle of a Macro PDF set entry. All user-selected fields are prefixed by \923 for GLIs, and \C923C for ECIs. Tags and examples in the following parameters demonstrate GLI protocol, but you can use the ECI tag (\C923C) instead if ECI protocol is enabled.

### Transmit File Name

#### Parameter # B0h

Transmit File Name activates transmission of the file name field. The field character tag is \923\000. For example, the filename MANHOURS.WK1 is sent as: \923\000MANHOURS.WK1.



**Enable File Name Transmit**

**(01h)**



**\*Disable File Name Transmit**

**(00h)**

## Transmit Block Count

### Parameter # B1h

Transmit Block Count activates transmission of the block count field. The field character tag is \923\001. For example, the field may be: \923\0011856.



**Enable Transmit Block Count**

**(01h)**



**\*Disable Transmit Block Count**

**(00h)**

## Transmit Time Stamp

### Parameter # B2h

Transmit Time Stamp activates transmission of the time stamp field. The field character tag is \923\002. For example, the field may be: \923\0022123443243234.



**Enable Transmit Time Stamp**

**(01h)**



**\*Disable Transmit Time Stamp**

**(00h)**

## Transmit Sender

### Parameter # B3h

Transmit Sender activates transmission of the sender field. The field character tag is \923\003. For example, the field may be: \923\003Zebra Holtsville, NY.



**Enable Sender Transmit**

**(01h)**



**\*Disable Sender Transmit**

**(00h)**

## Transmit Addressee

### Parameter # B4h

Transmit Addressee activates transmission of the addressee field. The field character tag is \923\004. For example, the field may be: \923\004AIM USA.



**Enable Addressee Transmit**

**(01h)**



**\*Disable Addressee Transmit**

**(00h)**



## Transmit Checksum

### Parameter # B6h

Transmit Checksum activates transmission of the checksum field. The field character tag is \923\006. For example, the field may be: \923\00663823.



**Enable Checksum Transmit**

**(01h)**



**\*Disable Checksum Transmit**

**(00h)**

## Transmit File Size

### Parameter # B5h

Transmit File Size activates transmission of the file size field. The field character tag is \923\005. For example, the field may be: \923\005179234.



**Enable File Size Transmit**

**(01h)**



**\*Disable File Size Transmit**

**(00h)**

## Transmit Macro PDF Control Header

### Parameter # B7h

Transmit Macro PDF Control Header activates transmission of the control header, which contains the segment index and the file ID. For example, the field can be: \92800000\725\120\343. The five digits after the \928 are the segment index (or block index), and \725\120\343 is the file ID.



**Enable Macro PDF Control Header  
Transmit  
(01h)**



**\*Disable Macro PDF Control Header  
Transmit  
(00h)**

## Last Blocker Marker

### Parameter # B9h

**Enable Last Block Marker** marks the last block in the set by the codeword \922.



**Enable Last Block Marker  
(01h)**



**\*Disable Last Block Marker  
(00h)**

---

## Numeric Bar Codes

For parameters requiring specific numeric values, scan the appropriately numbered bar code(s).



0



1



2



3



4

---

## Numeric Bar Codes (continued)



5



6



7



8



9

## Cancel

To change a selection or cancel an incorrect entry, scan the bar code below.



**Cancel**



# Chapter 11 Simple Serial Interface (SSI)

---

## Introduction

MiniScan scanners communicate with a host device using the Simple Serial Interface (SSI). This interface is only available on MSXX04 models.

The *Simple Serial Interface (SSI) Programmer's Guide* (p/n 72-40451-xx) and *Simple Serial Interface (SSI) Developer's Guide* (p/n 72-50705-xx) provide general information on SSI, include information on the decoder's hardware signals, and describe the commands. The following SSI information is specific to the MiniScan scanner.

✓ **NOTE** MiniScan scanners only support Multipackaging Option 1. See the *SSI Programmer's Guide* for more information.

---

## Revision String

When the decoder sends the REPLY\_REVISION message, the revision string is in the following format:

```
S/W_REVISION <space> BOARD_TYPE <space> ENGINE_CODE <space> PGM_CHKSUM
```

where:

- **S/W\_REVISION** is the release name of the software
- **BOARD\_TYPE** is *N* for non-flash decoder board, *F* for flash
- **ENGINE\_CODE** indicates the type of scanner paired with the decoder
- **PGM\_CHKSUM** is the two-byte checksum of the program code.

*Table 11-1* lists the codes identifying the MiniScan scanner when using SSI.

**Table 11-1** *MiniScan Codes*

Code	Description
07h	MS1204FZY
38h	MS2204
3Eh	MS2204VHD
48h	MS3204-I000
4ch	MS3204-E000
37h	MS954

---

## SSI Commands Not Supported

The MiniScan scanner do NOT support the following SSI commands included in the *Simple Serial Interface (SSI) Programmer's Guide*:

- C4h AIM\_OFF
- C5h AIM\_ON
- B1h IMAGE\_DATA
- F7h IMAGER\_MODE
- B4h VIDEO\_DATA



# Chapter 12 Mounting Templates

---

## Introduction

This chapter provides mounting templates for MiniScan scanners. Copy the page with your MiniScan model's template to aid in mounting.

### **MS1204FZY/MS2204/MS2204VHD Mounting Template**

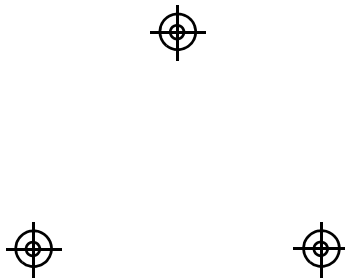

**Figure 12-1** *MS1204FZY/MS2204/MS2204VHD Mounting Template*

## MS3204 Mounting Template

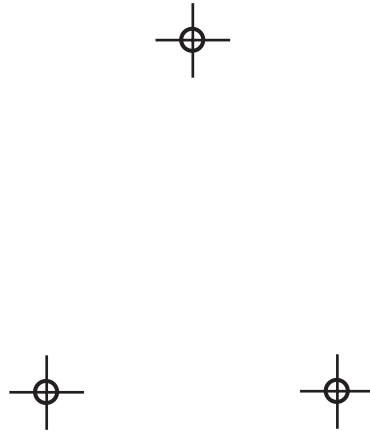

Figure 12-2 MS3204 Mounting Template

## MS954 Mounting Template

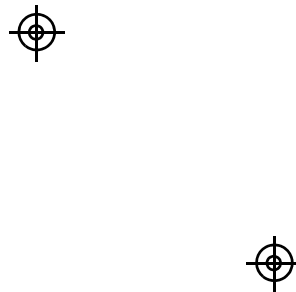

Figure 12-3 MS954 Mounting Template

# Appendix A ASCII Character Sets

## RS-232 ASCII Character Set

You can assign the values in [Table A-1](#) as prefixes or suffixes for ASCII character data transmission in an RS-232 environment.

**Table A-1** *Prefix/Suffix Values*

Prefix/Suffix Value	Full ASCII Code 39 Encode Character	ASCII Character
1000	%U	NUL
1001	\$A	SOH
1002	\$B	STX
1003	\$C	ETX
1004	\$D	EOT
1005	\$E	ENQ
1006	\$F	ACK
1007	\$G	BELL
1008	\$H	BACKSPACE
1009	\$I	HORIZONTAL TAB
1010	\$J	LF/NEW LINE
1011	\$K	VT
1012	\$L	FF
1013	\$M	CR/ENTER
1014	\$N	SO
1015	\$O	SI

**Table A-1** Prefix/Suffix Values (Continued)

Prefix/Suffix Value	Full ASCII Code 39 Encode Character	ASCII Character
1016	\$P	DLE
1017	\$Q	DC1
1018	\$R	DC2
1019	\$S	DC3
1020	\$T	DC4
1021	\$U	NAK
1022	\$V	SYN
1023	\$W	ETB
1024	\$X	CAN
1025	\$Y	EM
1026	\$Z	SUB
1027	%A	ESC
1028	%B	FS
1029	%C	GS
1030	%D	RS
1031	%E	US
1032	Space	Space
1033	/A	!
1034	/B	"
1035	/C	#
1036	/D	\$
1037	/E	%
1038	/F	&
1039	/G	'
1040	/H	(
1041	/I	)
1042	/J	*
1043	/K	+
1044	/L	,

**Table A-1** *Prefix/Suffix Values (Continued)*

Prefix/Suffix Value	Full ASCII Code 39 Encode Character	ASCII Character
1045	-	-
1046	.	.
1047	/O	/
1048	0	0
1049	1	1
1050	2	2
1051	3	3
1052	4	4
1053	5	5
1054	6	6
1055	7	7
1056	8	8
1057	9	9
1058	/Z	:
1059	%F	;
1060	%G	<
1061	%H	=
1062	%I	>
1063	%J	?
1064	%V	@
1065	A	A
1066	B	B
1067	C	C
1068	D	D
1069	E	E
1070	F	F
1071	G	G
1072	H	H
1073	I	I

**Table A-1** *Prefix/Suffix Values (Continued)*

Prefix/Suffix Value	Full ASCII Code 39 Encode Character	ASCII Character
1074	J	J
1075	K	K
1076	L	L
1077	M	M
1078	N	N
1079	O	O
1080	P	P
1081	Q	Q
1082	R	R
1083	S	S
1084	T	T
1085	U	U
1086	V	V
1087	W	W
1088	X	X
1089	Y	Y
1090	Z	Z
1091	%K	[
1092	%L	\
1093	%M	]
1094	%N	^
1095	%O	_
1096	%W	`
1097	+A	a
1098	+B	b
1099	+C	c
1100	+D	d
1101	+E	e
1102	+F	f

**Table A-1** *Prefix/Suffix Values (Continued)*

Prefix/Suffix Value	Full ASCII Code 39 Encode Character	ASCII Character
1103	+G	g
1104	+H	h
1105	+I	i
1106	+J	j
1107	+K	k
1108	+L	l
1109	+M	m
1110	+N	n
1111	+O	o
1112	+P	p
1113	+Q	q
1114	+R	r
1115	+S	s
1116	+T	t
1117	+U	u
1118	+V	v
1119	+W	w
1120	+X	x
1121	+Y	y
1122	+Z	z
1123	%P	{
1124	%Q	
1125	%R	}
1126	%S	~
1127		Undefined
7013		ENTER

## USB ASCII Character Set

Use the values in [Table A-2](#) for ASCII character data transmission in a USB environment.

**Table A-2** USB ASCII Character Set

Prefix/ Suffix Value	Full ASCII Code 39 Encode Char.	Keystroke
1000	%U	CTRL 2
1001	\$A	CTRL A
1002	\$B	CTRL B
1003	\$C	CTRL C
1004	\$D	CTRL D
1005	\$E	CTRL E
1006	\$F	CTRL F
1007	\$G	CTRL G
1008	\$H	CTRL H / <b>BACKSPACE*</b>
1009	\$I	CTRL I / <b>HORIZONTAL TAB*</b>
1010	\$J	CTRL J
1011	\$K	CTRL K
1012	\$L	CTRL L
1013	\$M	CTRL M / <b>ENTER*</b>
1014	\$N	CTRL N
1015	\$O	CTRL O
1016	\$P	CTRL P
1017	\$Q	CTRL Q
1018	\$R	CTRL R
1019	\$S	CTRL S
1020	\$T	CTRL T
1021	\$U	CTRL U
1022	\$V	CTRL V
1023	\$W	CTRL W

**\*The keystroke in bold transmits only if you enabled Function Key Mapping.**



**Table A-2** USB ASCII Character Set (Continued)

Prefix/ Suffix Value	Full ASCII Code 39 Encode Char.	Keystroke
1024	\$X	CTRL X
1025	\$Y	CTRL Y
1026	\$Z	CTRL Z
1027	%A	CTRL [ / <b>ESC*</b>
1028	%B	CTRL \
1029	%C	CTRL ]
1030	%D	CTRL 6
1031	%E	CTRL -
1032	Space	Space
1033	/A	!
1034	/B	"
1035	/C	#
1036	/D	\$
1037	/E	%
1038	/F	&
1039	/G	'
1040	/H	(
1041	/I	)
1042	/J	*
1043	/K	+
1044	/L	,
1045	-	-
1046	.	.
1047	/o	/
1048	0	0
1049	1	1
1050	2	2

**\*The keystroke in bold transmits only if you enabled Function Key Mapping.**

**Table A-2** USB ASCII Character Set (Continued)

Prefix/ Suffix Value	Full ASCII Code 39 Encode Char.	Keystroke
1051	3	3
1052	4	4
1053	5	5
1054	6	6
1055	7	7
1056	8	8
1057	9	9
1058	/Z	:
1059	%F	;
1060	%G	<
1061	%H	=
1062	%I	>
1063	%J	?
1064	%V	@
1065	A	A
1066	B	B
1067	C	C
1068	D	D
1069	E	E
1070	F	F
1071	G	G
1072	H	H
1073	I	I
1074	J	J
1075	K	K
1076	L	L
1077	M	M

**\*The keystroke in bold transmits only if you enabled Function Key Mapping.**

**Table A-2** USB ASCII Character Set (Continued)

Prefix/ Suffix Value	Full ASCII Code 39 Encode Char.	Keystroke
1078	N	N
1079	O	O
1080	P	P
1081	Q	Q
1082	R	R
1083	S	S
1084	T	T
1085	U	U
1086	V	V
1087	W	W
1088	X	X
1089	Y	Y
1090	Z	Z
1091	%K	[
1092	%L	\
1093	%M	]
1094	%N	^
1095	%O	_
1096	%W	`
1097	+A	<b>a</b>
1098	+B	<b>b</b>
1099	+C	<b>c</b>
1100	+D	<b>d</b>
1101	+E	<b>e</b>
1102	+F	<b>f</b>
1103	+G	<b>g</b>
1104	+H	<b>h</b>

**\*The keystroke in bold transmits only if you enabled Function Key Mapping.**

**Table A-2** USB ASCII Character Set (Continued)

Prefix/ Suffix Value	Full ASCII Code 39 Encode Char.	Keystroke
1105	+I	i
1106	+J	j
1107	+K	k
1108	+L	l
1109	+M	m
1110	+N	n
1111	+O	o
1112	+P	p
1113	+Q	q
1114	+R	r
1115	+S	s
1116	+T	t
1117	+U	u
1118	+V	v
1119	+W	w
1120	+X	x
1121	+Y	y
1122	+Z	z
1123	%P	{
1124	%Q	
1125	%R	}
1126	%S	~
<b>ALT Keys</b>	<b>Keystroke</b>	
2064	ALT 2	
2065	ALT A	
2066	ALT B	
2067	ALT C	

**\*The keystroke in bold transmits only if you enabled Function Key Mapping.**

**Table A-2** USB ASCII Character Set (Continued)

Prefix/ Suffix Value	Full ASCII Code 39 Encode Char.	Keystroke
2068	ALT D	
2069	ALT E	
2070	ALT F	
2071	ALT G	
2072	ALT H	
2073	ALT I	
2074	ALT J	
2075	ALT K	
2076	ALT L	
2077	ALT M	
2078	ALT N	
2079	ALT O	
2080	ALT P	
2081	ALT Q	
2082	ALT R	
2083	ALT S	
2084	ALT T	
2085	ALT U	
2086	ALT V	
2087	ALT W	
2088	ALT X	
2089	ALT Y	
2090	ALT Z	

**\*The keystroke in bold transmits only if you enabled Function Key Mapping.**

**Table A-2** USB ASCII Character Set (Continued)

Prefix/ Suffix Value	Full ASCII Code 39 Encode Char.	Keystroke
<b>Other Value</b>		<b>Keystroke</b>
GUI Shift Keys		
The Apple™ iMac keyboard has an apple key on either side of the space bar. Windows-based systems have a GUI key to the left of the left ALT key, and to the right of the right ALT key.		
3000		Right Control Key
3048		GUI 0
3049		GUI 1
3050		GUI 2
3051		GUI 3
3052		GUI 4
3053		GUI 5
3054		GUI 6
3055		GUI 7
3056		GUI 8
3057		GUI 9
3065		GUI A
3066		GUI B
3067		GUI C
3068		GUI D
3069		GUI E
3070		GUI F
3071		GUI G
3072		GUI H
3073		GUI I
3074		GUI J
3075		GUI K
3076		GUI L
3077		GUI M

**\*The keystroke in bold transmits only if you enabled Function Key Mapping.**

**Table A-2** USB ASCII Character Set (Continued)

Prefix/ Suffix Value	Full ASCII Code 39 Encode Char.	Keystroke
3078	GUI N	
3079	GUI O	
3080	GUI P	
3081	GUI Q	
3082	GUI R	
3083	GUI S	
3084	GUI T	
3085	GUI U	
3086	GUI V	
3087	GUI W	
3088	GUI X	
3089	GUI Y	
3090	GUI Z	
<b>F Keys</b>	<b>Keystroke</b>	
5001	F1	
5002	F2	
5003	F3	
5004	F4	
5005	F5	
5006	F6	
5007	F7	
5008	F8	
5009	F9	
5010	F10	
5011	F11	
5012	F12	
5013	F13	

**\*The keystroke in bold transmits only if you enabled Function Key Mapping.**

**Table A-2** USB ASCII Character Set (Continued)

Prefix/ Suffix Value	Full ASCII Code 39 Encode Char.	Keystroke
5014	F14	
5015	F15	
5016	F16	
5017	F17	
5018	F18	
5019	F19	
5020	F20	
5021	F21	
5022	F22	
5023	F23	
5024	F24	
<b>Keypad</b>	<b>Keystroke</b>	
6042	*	
6043	+	
6044	undefined	
6045	-	
6046	.	
6047	/	
6048	0	
6049	1	
6050	2	
6051	3	
6052	4	
6053	5	
6054	6	
6055	7	
6056	8	

**\*The keystroke in bold transmits only if you enabled Function Key Mapping.**



**Table A-2** USB ASCII Character Set (Continued)

Prefix/ Suffix Value	Full ASCII Code 39 Encode Char.	Keystroke
6057	9	
6058	Enter	
6059	Num Lock	
<b>Extended Keypad</b>	<b>Keystroke</b>	
7001	Break	
7002	Delete	
7003	PgUp	
7004	End	
7005	Pg Dn	
7006	Pause	
7007	Scroll Lock	
7008	Backspace	
7009	Tab	
7010	Print Screen	
7011	Insert	
7012	Home	
7013	Enter	
7014	Escape	
7015	Up Arrow	
7016	Down Arrow	
7017	Left Arrow	
7018	Right Arrow	

**\*The keystroke in bold transmits only if you enabled Function Key Mapping.**



# Glossary

---

## A

**AIM.** Automatic Identification Manufacturers, Inc. is the trade association for manufacturers of automatic identification systems.

**Alphanumeric.** A character set that contains letters, numbers and other characters such as special symbols.

**Aperture.** The opening in an optical system defined by a lens or baffle that establishes the field of view.

**ASCII.** American Standard Code for Information Interchange. A 7 bit-plus-parity code representing 128 letters, numerals, punctuation marks and control characters. It is a standard data transmission code in the U.S.

**Aspect Ratio.** The ratio of symbol height to symbol length in a 2-dimensional symbol.

**Autodiscrimination.** The ability of an interface controller to determine the code type of a scanned bar code. After this determination is made, the information content is decoded.

**Automatic Identification System.** The application of various technologies, such as bar code recognition, image recognition, voice recognition and RF/MW transponders, for the purpose of data entry into a data processing system and bypassing the key-entry component of traditional data entry.

---

## B

**Background.** The area surrounding a printed symbol including the spaces and quiet zones.

**Bar.** The dark element in a printed bar code symbol.

**Bar Code.** A pattern of variable-width bars and spaces which represents numeric or alphanumeric data in machine-readable form. The general format of a bar code symbol consists of a leading margin, start character, data or message character, check character (if any), stop character, and trailing margin. Within this framework, each recognizable symbology uses its own unique format. See **Symbology**.

**Bar Code Character.** A single group of bars and spaces which represent an individual number, letter, punctuation mark or other symbol.

**Bar Code Density.** The number of characters represented per unit of measurement (e.g., characters per inch).

**Bar Code Reader.** A device used to read or decode a bar code symbol.

**Bar Code Symbol.** The combination of symbol characters and features required by a particular symbology, including quiet zones, start and stop characters, data characters, check characters and other auxiliary patterns, that together form a complete scannable entity. See **Symbol**.

**Bar Height.** The dimension of a bar measured perpendicular to the bar width.

**Bar Width.** Thickness of a bar measured from the edge closest to the symbol start character to the trailing edge of the same bar.

**Baud Rate.** A measure of the data flow or number of signaling events occurring per second. When one bit is the standard "event," this is a measure of bits per second (bps). For example, a baud rate of 50 means transmission of 50 bits of data per second.

**Bi-directional.** Denotes that a machine-readable symbol can be read successfully in two directions – either backwards or forwards. Also identifies a scanner that can operate on a bar code that can be read independent of scanning direction.

**Binary.** Denotes a numbering system to base 2 in which numbers are expressed as combinations of the digits 0 and 1 with positional weighting based on powers of 2. In computing, these can be represented electrically by 'off' and 'on' respectively or in machine-readable symbols by narrow and wide elements or by the absence or presence of a bar module.

**Bit.** Binary digit. One bit is the basic unit of binary information. Generally, eight consecutive bits compose one byte of data. The pattern of 0 and 1 values within the byte determines its meaning.

**Bits per Second (bps).** Bits transmitted or received.

**bps.** See **Bits Per Second**.

**Byte.** On an addressable boundary, eight adjacent binary digits (0 and 1) combined in a pattern to represent a specific character or numeric value. Bits are numbered from the right, 0 through 7, with bit 0 the low-order bit. One byte in memory is used to store one ASCII character.

or

A sequential series of bits comprising one character and handled as one unit. Usually encoded in the ASCII format, a byte usually consists of eight bits and represents one alphabetic or special character, two decimal digits or eight binary bits.

---

## C

**CDRH.** Center for Devices and Radiological Health. A federal agency responsible for regulating laser product safety. This agency specifies various laser operation classes based on power output during operation.

**CDRH Class 1.** This is the lowest power CDRH laser classification. CDRH Class 1 devices are safe under reasonably foreseeable conditions of operation. Software and other controls to limit exposure to laser light may be required to achieve CDRH Class 1 operation. The CDRH time base for Class 1 devices is 10,000 seconds.

**CDRH Class 2.** CDRH Class II devices may not emit more than 1 milliwatt average radiant power. Eye protection for CDRH Class II devices is normally afforded by aversion responses, including the blink reflex.

**Character.** A pattern of bars and spaces which either directly represents data or indicates a control function, such as a number, letter, punctuation mark, or communications control contained in a message.

**Character Set.** Those characters available for encoding in a particular bar code symbology.

**Check Digit.** A digit used to verify a correct symbol decode. The scanner inserts the decoded data into an arithmetic formula and checks that the resulting number matches the encoded check digit. Check digits are required for UPC but are optional for other symbologies. Using check digits decreases the chance of substitution errors when a symbol is decoded.

**Codabar.** A discrete self-checking code with a character set consisting of digits 0 to 9 and six additional characters: ( - \$ : / , +).

**Code.** A set of unambiguous rules specifying the way in which data may be represented as numbers and letters used to represent information. See **Number System**.

**Code 128.** A high density symbology which allows the controller to encode all 128 ASCII characters without adding extra symbol elements.

**Code 3 of 9 (Code 39).** A versatile and widely used alphanumeric bar code symbology with a set of 43 character types, including all uppercase letters, numerals from 0 to 9 and 7 special characters ( - . / + % \$ and space). The code name is derived from the fact that 3 of 9 elements representing a character are wide, while the remaining 6 are narrow.

**Code 93.** An industrial symbology compatible with Code 39 but offering a full character ASCII set and a higher coding density than Code 39.

**Code Length.** Number of data characters in a bar code between the start and stop characters, not including those characters.

**Codeword.** As a symbol character value, this is an intermediate level of coding between source data and the graphical encodation in the symbol.

**COM port.** Communication port; ports are identified by number, e.g., COM1, COM2.

**Concatination.** The construction of a string of data from two or more strings by appending each string in succession. The linking or chaining together of separate items of data in a bar code symbol or of the data contained in two or more separate bar code symbols (also referred to as message append and structured append).

**Continuous Code.** A bar code or symbol in which all spaces within the symbol are parts of characters. There are no intercharacter gaps in a continuous code. The absence of gaps allows for greater information density.

**Contrast.** The difference in reflectance between the black and white (or bar and space) areas of a symbol.

---

## D

**Data Identifier.** A specified character or string of characters that defines the intended use of the data element that follows. For the purposes of automatic data capture technologies, data identifier refers to the alphanumeric identifiers as defined in ANSI MH10.8.2, formerly known as ANSI/FACT data identifiers.

**Data Matrix.** This error correcting, 2-dimensional matrix symbology was originally developed in 1989, and a finalized design was completed in 1995 by International Data Matrix. It's capable of encoding various character sets including strictly numeric data, alphanumeric data and all ISO 646 (ASCII) characters, as well as special character sets. The symbology has both error detection and error correction features. Each Data Matrix symbol consists of data regions, which contain nominally square modules set out in a regular array. A dark module is a binary 1 and a light module is a binary 0. There is no specified minimum or maximum for the X or Y dimension. The data region is surrounded by a finder pattern, a perimeter to the data region that is 1 module wide, which is surrounded by a quiet zone on all four sides of the symbol. Two adjacent sides are solid dark lines used primarily to define physical size, orientation and symbol distortion. The two opposite sides consist of alternating dark and light modules. These are used primarily to define the cell structure but also assist in determining physical size and distortion. There are 2 types of Data Matrix symbologies: ECC 000 - 140 with several available levels of convolutional error correction, and ECC 200, which uses Reed-Solomon error correction. For ISO/IEC JTC 1/SC 31 purposes, only ECC 200 is recommended. The intellectual property rights associated with Data Matrix have been committed to the public domain.

**Data Structure.** The stipulation of the type of information that is included in a bar code, such as its order and format.

**Dead Zone.** An area within a scanner's field of view, in which specular reflection may prevent a successful decode.

**Decode.** To recognize a bar code symbology (e.g., UPC/EAN) and then analyze the content of the specific bar code scanned.

**Decode Algorithm.** A decoding scheme that converts pulse widths into data representation of the letters or numbers encoded within a bar code symbol.

**Decoder.** An electronic package that receives the signals from the scanning function, performs the algorithm to interpret the signals into meaningful data and provides the interface to other devices.

**Decryption.** Decryption is the decoding and unscrambling of received encrypted data. Also see, **Encryption** and **Key**.

**Depth of Field.** The range between minimum and maximum distances at which a scanner can read a symbol with a certain minimum element width.

**Diffuse Reflection.** The component of reflected light that emanates in all directions from the reflecting surface.

**Discrete 2 of 5.** A binary bar code symbology representing each character by a group of five bars, two of which are wide. The location of wide bars in the group determines which character is encoded; spaces are insignificant. Only numeric characters (0 to 9) and START/STOP characters may be encoded.

**Discrete Code.** A bar code or symbol in which the spaces between characters (intercharacter gaps) are not part of the code.

**DRAM.** Dynamic random access memory.

---

## E

**EAN.** European Article Number. This European/International version of the UPC provides its own coding format and symbology standards. Element dimensions are specified metrically. EAN is used primarily in retail.

**EAN/UPC.** A fixed-length, numeric 13-digit bar code symbol consisting of 30 dark elements and 29 intervening light elements. Each character is represented by 2 bars and 2 spaces over 7 modules. A bar may be comprised of 1, 2, 3 or 4 modules. Each EAN/U.P.C. symbol consists of a leading quiet zone, a start pattern, 7 left-hand data characters, a center bar pattern, 5 right-hand data characters, a Modulo 10 check character, a stop pattern and a trailing quiet zone.

U.P.C. is often considered a 12-digit code. The 13th digit of EAN/U.P.C. symbol is a derived character in the left-most position. In the case of U.P.C., this derived left-most character is a 0.

**Element.** Generic term for a bar or space.

**Encoded Area.** Total linear dimension occupied by all characters of a code pattern, including start/stop characters and data.

**ENQ (RS-232).** ENQ software handshaking is also supported for the data sent to the host.

**Error Correction.** A reader or decoder's use of mathematical schemes to reconstruct or replace damaged or missing symbol characters to enable the reading of the symbol data.

**Error-Correction Characters.** Symbol characters used for error correction and detection, calculated automatically from the other symbol characters.

**Error-Correction Level.** An indicator of the number of characters used in a symbology for error correction. A higher level of error correction allows for correcting greater potential symbol damage.

**Error Detection.** This occurs when error-correction characters detect that the presence of errors in the symbol exceeds the error correction capacity, and keeps the symbol from being decoded as erroneous data.

**Error-Detection Characters.** Symbol characters reserved for error detection that are calculated automatically from the other symbol characters.

**ESD.** Electro-Static Discharge

---

## F

**Fixed Beam Bar Code Reader.** A scanning device where scanning motion is achieved by moving the object relative to the reader; as opposed to a moving beam reader.

---

## G

**GS1 DataBar.** Formerly Reduced Space Symbology (RSS): A family of space efficient symbologies developed by UCC.EAN.

**Guard Bars.** Bars located at both ends and the center of a UPC and EAN symbol to provide reference points for scanning.

---

## H

**Horizontal Bar Code.** A bar code or symbol with an overall length dimension that is parallel to the horizon, which resembles a picket fence.

**Host Computer.** A computer that serves other terminals in a network, providing such services as computation, database access, supervisory programs and network control.

**Hz.** Hertz; A unit of frequency equal to one cycle per second.

---

## I

**IEC.** International Electrotechnical Commission. This international agency regulates laser safety by specifying various laser operation classes based on power output during operation.

**IEC 60825-1 Class 1.** This is the lowest power IEC laser classification. IEC Class 1 devices are safe under reasonably foreseeable conditions of operation. Software and other controls to limit exposure to laser light may be required to achieve IEC Class 1 operation. The IEC time base for Class 1 devices is 100 seconds if intentional viewing of laser light is not required in the design or function of the device. The IEC time base for Class 1 devices is 30,000 seconds where intentional viewing of laser light is inherent in the design or function of the device.

**Input/Output Ports.** I/O ports are primarily dedicated to passing information into or out of the terminal memory. Series 9000 mobile computers include Serial and USB ports.

**Intercharacter Gap.** The space between two adjacent bar code characters in a discrete code.

**Interleaved 2 of 5.** A binary bar code symbology representing character pairs in groups of five bars and five interleaved spaces. Interleaving provides for greater information density. The location of wide elements (bar/spaces) within each group determines which characters are encoded. This continuous code type uses no intercharacter spaces. Only numeric (0 to 9) and START/STOP characters may be encoded.

**Interleaved Bar Code.** A bar code in which characters are paired together, using bars to represent the first character and the intervening spaces to represent the second.

**I/O Ports.** interface The connection between two devices, defined by common physical characteristics, signal characteristics, and signal meanings. Types of interfaces include RS-232 and PCMCIA.

---

## K

**Key.** A key is the specific code used by the algorithm to encrypt or decrypt the data. Also see, **Encryption** and **Decrypting**.

---

## L

**LASER.** Light Amplification by Stimulated Emission of Radiation. The laser is an intense light source. Light from a laser is all the same frequency, unlike the output of an incandescent bulb. Laser light is typically coherent and has a high energy density.

**Laser Diode.** A gallium-arsenide semiconductor type of laser connected to a power source to generate a laser beam. This laser type is a compact source of coherent light.

**Laser Scanner.** An optical bar code reading device using a coherent laser light beam as its source of illumination.

**LCD.** See **Liquid Crystal Display**.



**LED Indicator.** A semiconductor diode (LED - Light Emitting Diode) used as an indicator, often in digital displays. The semiconductor uses applied voltage to produce light of a certain frequency determined by the semiconductor's particular chemical composition.

**Light Emitting Diode.** See **LED**.

**Liquid Crystal Display (LCD).** A display that uses liquid crystal sealed between two glass plates. The crystals are excited by precise electrical charges, causing them to reflect light outside according to their bias. They use little electricity and react relatively quickly. They require external light to reflect their information to the user.

---

## M

**Matrix Symbols.** A 2-dimensional array of regular polygon shaped cells where the center-to-center distance of adjacent elements is uniform. The arrangement of the cells represents data and/or symbology functions. Matrix symbols may include recognition patterns that do not follow the same rule as the other elements within the symbol (i.e., Data Matrix and Maxicode).

**MIL.** 1 mil = 1 thousandth of an inch; a unit of measure often used to quantify bar code printing and scanning dimensions.

**Misread (Misdecode).** A condition which occurs when the data output of a reader or interface controller does not agree with the data encoded within a bar code symbol.

**Module.** (1) The narrowest nominal width unit of measure in a symbol. In certain symbologies, element widths are specified as multiples of 1 module. Equivalent to X dimension; or (2) a single cell in a matrix symbology used to encode 1 bit of data. In Maxicode, the module shape is a regular hexagon. In Data Matrix, the module shape is nominally square. In PDF417, the module shape is a regular rectangle. In bar code symbologies, the module shape is a regular rectangle.

**Module Check Digit or Character.** A character within the symbol data field calculated using modular arithmetic that is used for error detection. The calculated character is determined by applying a code algorithm to the data field contents. See **Check Character**.

**Moving Beam Bar Code Reader.** A device where scanning motion is achieved by mechanically moving the optical geometry.

**MRD.** Minimum reflectance difference: a formula that is used to determine if there is an adequate difference between absorbed and reflected light.

---

## N

**Nanometer.** Unit of measure used to define the wavelength of light that is equal to  $10^{-9}$  meter.

**Nominal.** The exact (or ideal) intended value for a specified parameter. Tolerances are specified as positive and negative deviations from this value.

**Nominal Size.** Standard size for a bar code symbol. Most UPC/EAN codes are used over a range of magnifications (e.g., from 0.80 to 2.00 of nominal).

**Non-Contact Reader/Scanner.** Bar code readers requiring no physical contact with the printed symbol.

**Non-read.** The absence of data at the scanner output after an attempted scan, which is due to no code, defective code, scanner failure or operator error.

---

## O

**Omnidirectional.** Bar codes read in any orientation relative to the scanner.

**Optical Throw.** The distance from the scanner face to the closest point at which symbol can be read; also, optical throw is the difference between range and depth of field.

**Orientation.** The alignment of the symbol's scan path. Two possible orientations are horizontal with vertical bars and spaces (picket fence) and vertical with horizontal bars and spaces (ladder).

**Overhead.** The fixed number of characters required for start, stop and checking in a given symbol. For example, a symbol requiring a start, stop and 2 check characters contains 4 characters of overhead.

---

## P

**Parameter.** A variable that can have different values assigned to it.

**PDF417.** An error correcting 2-dimensional multi-row symbol developed in 1992 by Symbol Technologies, PDF417 symbols are constructed from 4 bars and 4 spaces over 17 modules. The symbol size is from 3 to 90 rows. There is no specified minimum or maximum for X or Y dimension. With at least the recommended minimum level of error correction, the recommended Y dimension is 3X. With less than the minimum recommended level of error correction, the recommended Y dimension is 4X. A quiet zone of 2X is specified on each side of a symbol. Because of delta decode techniques, the symbology is immune from uniform bar width growth. PDF417 supports cross-row scanning. The intellectual property rights associated with PDF417 have been committed to the public domain.

**Percent Decode.** The average probability that a single scan of a bar code would result in a successful decode. In a well-designed bar code scanning system, that probability should approach near 100%.

**Pitch.** Rotation of a bar code symbol in an axis parallel to the direction of the bars.

**Plessey Code.** A pulse-width, modulated bar code commonly used for shelf marking in grocery stores.

**Postnet Code.** Code developed by the U.S. Postal Service to assist in the automatic sorting of mail.

**Print Contrast Signal (PCS).** Measurement of the contrast (brightness difference) between the bars and spaces of a symbol. A minimum PCS value is needed for a bar code symbol to be scannable.  $PCS = (RL - RD) / RL$ , where RL is the reflectance factor of the background and RD the reflectance factor of the dark bars.

**Programming Mode.** The state in which a scanner is configured for parameter values. See **Scanning Mode**.

---

## Q

**Quiet Zone.** A clear space, containing no dark marks, which precedes the start character of a bar code symbol and follows the stop character.

**QWERTY.** A standard keyboard commonly used on North American and some European PC keyboards. "QWERTY" refers to the arrangement of keys on the left side of the third row of keys.

---

## R

**Reflectance.** Amount of light returned from an illuminated surface.

**Resolution.** The narrowest element dimension which is distinguished by a particular reading device or printed with a particular device or method.

**RS-232.** An Electronic Industries Association (EIA) standard that defines the connector, connector pins, and signals used to transfer data serially from one device to another.

---

## S

**Scan Area.** Area intended to contain a symbol.

**Scanner.** An electronic device used to scan bar code symbols and produce a digitized pattern that corresponds to the bars and spaces of the symbol. Its three main components are: 1) Light source (laser or photoelectric cell) - illuminates a bar code; 2) Photodetector - registers the difference in reflected light (more light reflected from spaces); 3) Signal conditioning circuit - transforms optical detector output into a digitized bar pattern.

**Scanning Mode.** The scanner is energized, programmed and ready to read a bar code.

**Scanning Sequence.** A method of programming or configuring parameters for a bar code reading system by scanning bar code menus.

**Self-Checking Code.** A symbology that uses a checking algorithm to detect encoding errors within the characters of a bar code symbol.

**Skew.** Rotation of a bar code symbol on an axis parallel to the symbol's length.

**Space.** The lighter element of a bar code formed by the background between bars.

**Space Width.** The thickness of a space measured from the edge closest to the symbol start character to the trailing edge of the same space.

**Specular Reflection.** The mirror-like direct reflection of light from a surface, which can cause difficulty decoding a bar code.

**Stacked Symbol (2-D Symbols).** A 2-dimensional (2-D) symbol with sequences of linear (width-coded) data that are stacked one upon another (i.e., PDF417).

**Start/Stop Character.** A pattern of bars and spaces that provides the scanner with start and stop reading instructions and scanning direction. The start and stop characters are normally to the left and right margins of a horizontal code.

**Substrate.** A foundation material on which a substance or image is placed.

**Symbol.** A scannable unit that encodes data within the conventions of a certain symbology, usually including start/stop characters, quiet zones, data characters and check characters.

**Symbol Aspect Ratio.** The ratio of symbol height to symbol width.

**Symbol Density.** The number of data characters per unit length; usually expressed as characters per inch (CPI).

**Symbol Height.** The distance between the outside edges of the quiet zones of the first row and the last row.

**Symbol Length.** Length of symbol measured from the beginning of the quiet zone (margin) adjacent to the start character to the end of the quiet zone (margin) adjacent to a stop character.

**Symbology.** The structural rules and conventions for representing data within a particular bar code type (e.g. UPC/EAN, Code 39, PDF417, etc.).

---

## T

**Tilt.** Rotation of a bar code symbol on an axis perpendicular to the substrate.

**Tolerance.** Allowable deviation from the nominal bar or space width.

**Two-dimensional symbology.** A machine-readable symbol which must be examined both vertically and horizontally to read the entire message.

A 2-dimensional (2-D) symbol may be one of two types of machine-readable symbols: a Matrix Symbol or a stacked symbol. 2-D symbols differ from linear bar codes with the ability for high data content, small size, data efficiency and error correction capability.

---

## U

**UCC.** Uniform Code Council: the organization that administers the U.P.C and other retail standards.

**UCC.EAN-128.** Code 128 with a Function 1 character in the first position that is the symbology used with the UCC.EAN format for a universal product number (UPN).

**UPC.** Universal Product Code. A relatively complex numeric symbology. Each character consists of two bars and two spaces, each of which is any of four widths. The standard symbology for retail food packages in the United States.

---

## V

**Variable Length Code.** A code with a number of encoded characters within a range, as opposed to a code with a fixed number of encoded characters.

**Vertical Bar Code.** A bar code pattern presented in such orientation that the symbol from start to stop is perpendicular to the horizon. The individual bars are in an array appearing as rungs of a ladder.

**Visible Laser Diode (VLD).** A solid state device which produces visible laser light.

---

## W

**Wand Scanner.** A handheld scanning device used as a contact bar code or OCR reader.

**Wedge.** A device that plugs in between a keyboard and a terminal and allows data to be entered by a keyboard or by various types of scanners.

---

## X

**X Dimension.** The dimension of the narrowest bar and narrowest space in a bar code.

---

## Y

**Y Dimension.** The height of the modules in a row of a 2-dimensional (2-D) symbols.



# Index

## A

accessories	2-17
adding window	2-13
aiming modes	10-23
anti-reflection coaters	2-15
applications	1-3
fixed mount	1-3
OEM	1-3
assembling stand	2-4

## B

bar codes	
adaptive scanning	10-33
Chinese 2 of 5	10-86
codabar start and stop characters	10-93
coupon report	10-58
enhanced aim timeouts	10-22
GS1 databar limited security level	10-103
ISBT concatenation	10-61
ISSN EAN	10-57
Korean 3 of 5	10-85
korean 3 of 5	10-85
matrix 2 of 5	10-86
matrix 2 of 5 check digit	10-89
matrix 2 of 5 lengths	10-87
parameter pass through	10-29
transmit matrix 2 of 5 check digit	10-89
UPC/EAN	
supp redundancy	10-46
UPC/EAN/JAN	
supplemental AIM ID format	10-46
beeper	
definitions	3-7
beeper definitions	3-7
block diagram	1-3

bracket	
mounting scanner	2-5
bullets	xiv

## C

calculating the usable scan length	2-9, 2-10
Chinese 2 of 5	10-86
codabar bar codes	
start and stop characters	10-93
code 128 bar codes	
ISBT concatenation	10-61
codewords	10-125
transmit unknown	10-126
conventions	
notational	xiv
conveyor applications	
applications	
conveyor	2-12
coupon report	10-58

## D

decode zone	
MS1204FZY	4-7
MS2204	5-8
MS2204VHD	6-8
MS3204	7-8
default parameter	
MS1204, MS1204VHD, MS3204	10-14
MS954	10-15
default table	10-2
dimensions	
MS1204	4-6
MS2204	5-6
MS2204VHD	6-6
MS3204	7-6

MS954 ..... 8-6

**E**

ECI  
 decoder ..... 10-129  
 delete character set ECIs ..... 10-128  
 electrical interface  
 MS1204FZY ..... 4-1  
 MS2204 ..... 5-2  
 MS2204VHD ..... 6-1  
 MS3204 ..... 7-2  
 MS954 ..... 8-2  
 escape characters ..... 10-127

**G**

GS1 databar  
 GS1 databar limited security level ..... 10-103

**H**

humidity  
 MS1204FZY ..... 4-5  
 MS2204 ..... 5-6  
 MS2204VHD ..... 6-6  
 MS3204 ..... 7-6  
 MS954 ..... 8-5

**I**

information, service ..... xv  
 installation  
 connecting MiniScan ..... 2-7  
 connecting via RS-232 ..... 2-8  
 location ..... 2-9  
 mechanical drawing  
 MS1204FZY ..... 4-3  
 MS2204 ..... 5-3  
 MS2204VHD ..... 6-3  
 MS3204 ..... 7-3  
 MS954 ..... 8-3  
 mounting ..... 2-2  
 mounting scanner on bracket ..... 2-5  
 mounting scanner on stand ..... 2-4  
 mounting stand ..... 2-5  
 stand ..... 2-4  
 interface pin-outs ..... 4-1, 5-1, 6-1, 7-2, 8-2

**K**

Korean 3 of 5 bar codes ..... 10-85

**L**

laser class  
 MS1204FZY ..... 4-6  
 MS2204 ..... 5-6  
 MS2204VHD ..... 6-6  
 MS3204 ..... 7-6  
 MS954 ..... 8-6  
 laser driver ..... 3-1  
 laser power  
 MS1204FZY ..... 4-5  
 MS2204 ..... 5-5  
 MS2204VHD ..... 6-5  
 MS3204 ..... 7-5  
 MS954 ..... 8-5  
 LED  
 definitions ..... 3-7

**M**

macro PDF  
 delete character set ECIs ..... 10-128  
 ECI decoder ..... 10-129  
 escape characters ..... 10-127  
 last blocker marker ..... 10-134  
 transmit addressee ..... 10-132  
 transmit block count ..... 10-131  
 transmit checksum ..... 10-133  
 transmit file name ..... 10-130  
 transmit filesize ..... 10-133  
 transmit macro PDF control header ..... 10-134  
 transmit sender ..... 10-132  
 transmit symbols in codeword format ..... 10-125  
 transmit time stamp ..... 10-131  
 transmit unknown codewords ..... 10-126  
 transmit user-selected fields ..... 10-130  
 maintenance ..... 9-1  
 matrix 2 of 5 bar codes ..... 10-86  
 check digit ..... 10-89  
 lengths ..... 10-87  
 transmit check digit ..... 10-89  
 mechanical drawing  
 MS1204FZY ..... 4-3  
 MS2204 ..... 5-3  
 MS2204VHD ..... 6-3  
 MS3204 ..... 7-3  
 MS954 ..... 8-3  
 mounting ..... 2-2  
 mounting bracket ..... 2-5  
 mounting template ..... 12-1, 12-2

**N**

notational conventions ..... xiv



**O**

operational parameters . . . . . 10-2

**P**

parameters, operational . . . . . 10-2

pitch angle

MS1204FZY . . . . . 4-5

MS2204 . . . . . 5-5

MS2204VHD . . . . . 6-5

MS3204 . . . . . 7-5

MS954 . . . . . 8-5

power requirements

MS1204FZY . . . . . 4-5

MS2204 . . . . . 5-5

MS2204VHD . . . . . 6-5

MS3204 . . . . . 7-5

MS954 . . . . . 8-5

print contrast

MS1204FZY . . . . . 4-5

MS2204 . . . . . 5-5

MS2204VHD . . . . . 6-5

MS3204 . . . . . 7-5

MS954 . . . . . 8-5

programming bar codes

aiming mode . . . . . 10-23

beep after good decode . . . . . 10-26

beeper tone . . . . . 10-17

beeper volume . . . . . 10-16

bi-directional redundancy . . . . . 10-32

cancel . . . . . 10-137

Codabar . . . . . 10-90

CLSI editing . . . . . 10-92

enable/disable . . . . . 10-90

length . . . . . 10-91

NOTIS editing . . . . . 10-92

Code 11 . . . . . 10-74

check digit verification . . . . . 10-76

lengths . . . . . 10-75

transmit check digit . . . . . 10-77

Code 128 . . . . . 10-59

decode performance . . . . . 10-62

GS1-128 . . . . . 10-59

lengths . . . . . 10-61

Code 128 emulation . . . . . 10-100

Code 39 . . . . . 10-64

check digit verification . . . . . 10-68

Code 39 full ASCII . . . . . 10-69

decode performance . . . . . 10-70

lengths . . . . . 10-67

transmit check digit . . . . . 10-68

Trioptic Code 39 . . . . . 10-64

Code 93 . . . . . 10-72

lengths . . . . . 10-73

composite CC-A/B . . . . . 10-105

composite CC-C . . . . . 10-105

convert GS1 DataBar to UPC/EAN . . . . . 10-104

delete character set ECIs . . . . . 10-128

Discrete 2 of 5 . . . . . 10-82

lengths . . . . . 10-83

ECI decoder . . . . . 10-129

escape characters . . . . . 10-127

event reporting . . . . . 10-123–10-124

boot up event . . . . . 10-124

decode event . . . . . 10-123

parameter event . . . . . 10-124

GS1 DataBar . . . . . 10-101

GS1 DataBar Expanded . . . . . 10-102

GS1 DataBar Limited . . . . . 10-101

GS1 DataBar-14 . . . . . 10-101

Interleaved 2 of 5 . . . . . 10-78

check digit verification . . . . . 10-80

convert I 2 of 5 to EAN-13 . . . . . 10-81

lengths . . . . . 10-79

transmit check digit . . . . . 10-81

ISBT 128

enable/disable . . . . . 10-60

laser on time . . . . . 10-18

last blocker marker . . . . . 10-134

linear code type security . . . . . 10-30–10-31

linear UPC/EAN decode . . . . . 10-56

MicroPDF417 . . . . . 10-98

performance . . . . . 10-99

MSI plessey . . . . . 10-94

check digit algorithm . . . . . 10-97

check digits . . . . . 10-96

lengths . . . . . 10-95

transmit check digit . . . . . 10-96

numeric bar codes . . . . . 10-135

PDF417 . . . . . 10-98

power mode . . . . . 10-19

prefix/suffix values . . . . . 10-110

programmable raster size/expansion . . . . . 10-24

scan angle . . . . . 10-18

scan data transmission format . . . . . 10-111

scanning mode . . . . . 10-21

serial parameters

baud rate . . . . . 10-113

check parity . . . . . 10-118

data packet format . . . . . 10-121

host RTS line state . . . . . 10-120

host serial response time-out . . . . . 10-122

intercharacter delay . . . . . 10-122

parity . . . . . 10-117

software handshaking . . . . . 10-119

stop bit select . . . . . 10-121

set defaults . . . . . 10-14

SSI options	10-113
timeout between decodes	10-25
transmit addressee	10-132
transmit block count	10-131
transmit checksum	10-133
transmit code ID character	10-108
transmit file name	10-130
transmit filesize	10-133
transmit macro PDF control header	10-134
transmit macro PDF user-selected fields	10-130
transmit no read message	10-27, 10-28
transmit sender	10-132
transmit symbols in codeword format	10-125
transmit time stamp	10-131
transmit unknown codewords	10-126
trigger modes	10-20
UPC composite mode	10-107
UPC half block stitching	10-56
UPC/EAN	10-36
bookland EAN	10-39
bookland ISBN format	10-54
convert UPC-E to UPC-A	10-52
convert UPC-E1 to UPC-A	10-53
coupon code	10-40
decode supplementals	10-41
EAN zero extend	10-53
EAN-13	10-38
EAN-8	10-38
EAN-8 to EAN-13 type	10-55
security level	10-55
supplemental redundancy	10-45
supplementals	10-42
UPC-A	10-36
UPC-A check digit	10-47
UPC-A preamble	10-49
UPC-E	10-36
UPC-E check digit	10-47
UPC-E preamble	10-50
UPC-E1	10-37
UPC-E1 check digit	10-48
UPC-E1 preamble	10-51
user-programmable supplementals	10-45

## S

scan angle	
MS1204FZY	4-5
MS2204	5-5
MS2204VHD	6-5
MS3204	7-5
MS954	8-5
scan patterns	
cyclone omnidirectional	3-4
high density single scan line	3-2

raster	3-2, 3-3
single scan line	3-1
scan rate	
MS1204FZY	4-5
MS2204	5-5
MS2204VHD	6-5
MS3204	7-5
MS954	8-5
scanner pattern	3-1
scanning modes	10-21
scanning tips	3-5
service information	xv
skew, pitch and roll	
MS1204FZY	4-6
MS2204	5-7
MS2204VHD	6-7
MS3204	7-7
MS954	8-6
Software	2-18
software developer's kit	2-18
SSI	
Commands not Supported	11-2
Revision String	11-1
SSI demo	2-8
SSISDK	2-18
stand	
mounting	2-5
mounting scanner	2-4

## T

technical specifications	
MS3204	7-5
MS954	8-5
temperature	
MS120XFZY	4-5
MS2204	5-6
MS2204VHD	6-6
MS3204	7-6
MS954	8-5
theory of operation	
laser driver	3-1
power management	3-1
triggering	
host	3-5
troubleshooting	9-2

## U

UPC/EAN bar codes	
ISSN EAN	10-57
usable scan length	2-9, 2-10

**V**

## vibration

MS1204FZY .....	4-5
MS2204 .....	5-6
MS2204VHD .....	6-6
MS3204 .....	7-6
MS954 .....	8-5

**W**

## weight

MS1204FZY .....	4-6
MS2204 .....	5-6
MS2204VHD .....	6-6
MS3204 .....	7-6
MS954 .....	8-6

## window

adding .....	2-13
--------------	------

## window coatings .....

anti-reflection .....	2-15
polysiloxane .....	2-15

## window manufacturers .....

## window material .....

acrylic .....	2-14
CR-39 .....	2-14
glass .....	2-14

## window properties .....



# *Tell Us What You Think...*

We'd like to know what you think about this Manual. Please take a moment to fill out this questionnaire and fax this form to: (631) 627-7184, or mail to:

Zebra Technologies Corporation  
Lincolnshire, IL U.S.A.  
Attention: Technical Publications Manager  
Advanced Data Capture Division

**IMPORTANT:** If you need product support, please call the appropriate customer support number provided. Unfortunately, we cannot provide customer support at the fax number above.

Manual Title: \_\_\_\_\_  
(please include revision level)

How familiar were you with this product before using this manual?

- Very familiar     Slightly familiar     Not at all familiar

Did this manual meet your needs? If not, please explain.

---

---

---

---

What topics need to be added to the index, if applicable?

---

---

---

---

What topics do you feel need to be better discussed? Please be specific.

---

---

---

---

What can we do to further improve our manuals?

---

---

---

---







Zebra Technologies Corporation  
Lincolnshire, IL U.S.A.  
<http://www.zebra.com>

Zebra and the stylized Zebra head are trademarks of ZIH Corp., registered in many jurisdictions worldwide. All other trademarks are the property of their respective owners.

© 2017 Symbol Technologies LLC, a subsidiary of Zebra Technologies Corporation. All rights reserved.