

Magellan™ 9300i and 9400i

Scanner and Scanner-Scale with Imaging Technology



Quick Reference Guide

Datalogic ADC, Inc.

959 Terry Street
Eugene, OR 97402
USA

Telephone: (541) 683-5700

Fax: (541) 345-7140

©2014-2015 Datalogic ADC, Inc.

An Unpublished Work - All rights reserved. No part of the contents of this documentation or the procedures described therein may be reproduced or transmitted in any form or by any means without prior written permission of Datalogic ADC, Inc. or its subsidiaries or affiliates ("Datalogic" or "Datalogic ADC"). Owners of Datalogic products are hereby granted a non-exclusive, revocable license to reproduce and transmit this documentation for the purchaser's own internal business purposes. Purchaser shall not remove or alter any proprietary notices, including copyright notices, contained in this documentation and shall ensure that all notices appear on any reproductions of the documentation.

Should future revisions of this manual be published, you can acquire printed versions by contacting your Datalogic representative. Electronic versions may either be downloadable from the Datalogic website (www.datalogic.com) or provided on appropriate media. If you visit our website and would like to make comments or suggestions about this or other Datalogic publications, please let us know via the "Contact Datalogic" page.

Disclaimer

Datalogic has taken reasonable measures to provide information in this manual that is complete and accurate, however, Datalogic reserves the right to change any specification at any time without prior notice.

Datalogic and the Datalogic logo are registered trademarks of Datalogic S.p.A. in many countries, including the U.S.A. and the E.U. All other brand and product names may be trademarks of their respective owners.

Magellan is a registered trademark of Datalogic ADC, Inc. in many countries, including the U.S.A. and All-Weighs, FirstStrike, SmartSentry and SurroundScan are registered trademarks of Datalogic ADC, Inc. in the U.S.A. OmegaTek, Produce Rail, Productivity Index Reporting, and ScaleSentry are all trademarks of Datalogic ADC, Inc.

Patents

See www.patents.datalogic.com for patent list.

See the Regulatory Addendum included with your product for additional regulatory, safety and legal information.



Table of Contents

INTRODUCTION	1
Operation	1
Certification Label	2
Scanning Items	3
Weighing Items (Scale Models)	4
Scale Sentry™ Option	4
Electronic Article Surveillance (EAS) Deactivation Options	4
Sensormatic Coupled Mode	4
Sensormatic Decoupled Mode	4
Sensormatic Hybrid Mode	4
Controls and Indicators	5
Cleaning	6
CSS Option	6
LED and Beeper Indications	7
Error Codes	8
ScaleSentry™ Indications	8
Sensormatic® EAS Indications	8
Label Programming Mode Indications	8
Warranty	9

NOTES



Introduction

This manual provides user reference information for the following Magellan™ multi-plane imaging scanners and scanner-scales: Model 939401, Model 939403, Model 939404, Model 939405, and Model 939406.

With digital imagers in all planes, the 9300i/9400i scanner is capable of reading both 1D and 2D bar codes seamlessly without requiring item orientation by the cashier. This manual describes basic operation. For more detailed information about setup, installation and programming, see the Product Reference Guide for this product. These manuals are provided in Portable Document Format (PDF) for viewing and printing from the website listed on the back cover of this manual. Additionally, printed manuals can be ordered from your dealer/distributor.

Operation



If applicable, apply power to the EAS Controller box before powering on the scanner.

Certification Label

At the time the local scale regulatory authority certifies the scanner/scale for use, a certification label is affixed to the unit. Depending upon the size and shape of the label, placement can be made in one of the locations shown in Figure 1.

Figure 1. Affixing the Scale Certification Label

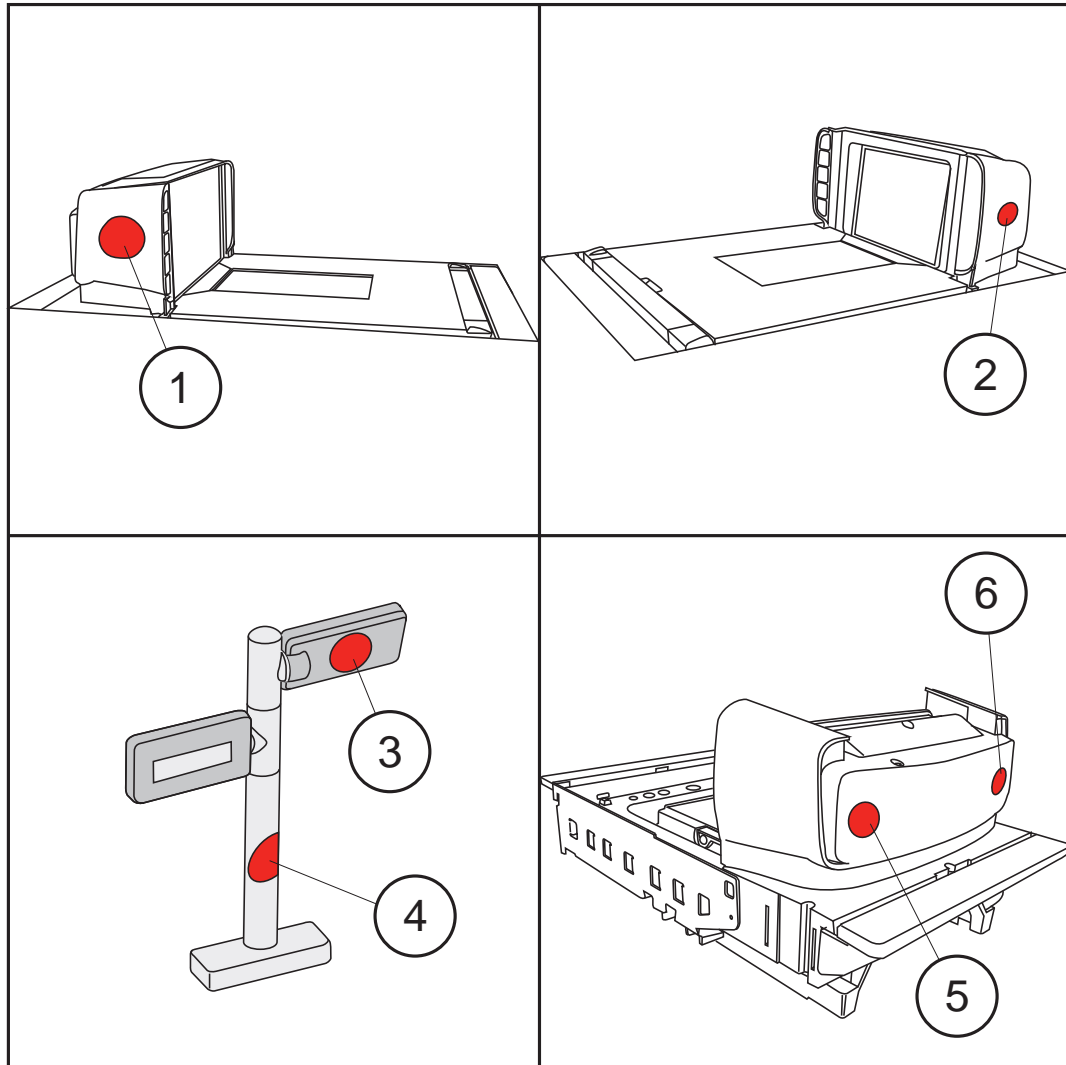

1	Left end of scanner bonnet	4	Remote Display Post
2	Right end of scanner bonnet	5	Back of Bonnet on either side of the logo.
3	Back of Remote Display Head	6	

Scanning Items

Slide or push items through the scan zone in a right-to-left or left-to-right movement. The scanner is equally efficient at scanning items in either direction. It is unnecessary to shift the position of the bar code, as the scanner can "read" it from the bottom, left, right, front and back side of an item, as long as it is fully within the scan zone.

Figure 2. Scan Zones

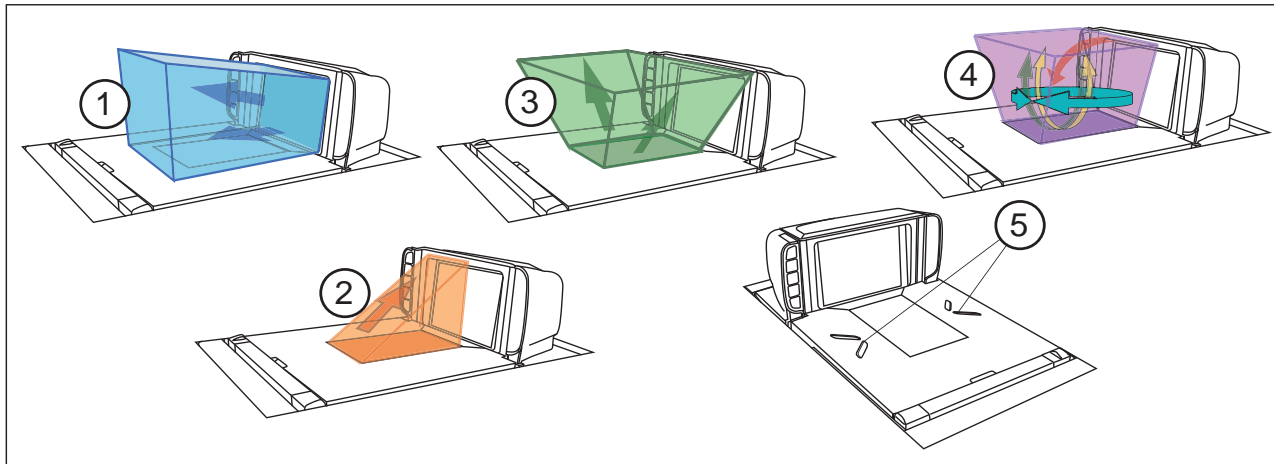

1	Vertical Window Scan Zone	4	Preferred Scan Zone "Sweet Spot"
2	Checker Side Scan Zone	5	Arrow Guides
3	Horizontal Window Scan Zone		

For best scanning results...

- Keep items in their natural orientation. Don't favor any of the scan windows.
- Use the arrow guides to (#6 in Figure 2) to center items over the horizontal window.
- Push or slide items instead of lifting them. Avoid unnecessary hand and wrist movements such as rotation, gripping or twisting, as this can cause repetitive motion injuries. This helpful technique can also allay the possibility of lifting thousands of pounds per day



NOTE

If a POS terminal holds the scanner in a disabled state, the scanner enters limited scanning mode which allows reading of programming labels but 'chirps' other labels.

The all-inclusive scan pattern and advanced FirstStrike™ decoding software ensures the scanner will read most hard-to-read codes quickly and without a need to particularly reorient items.

Weighing Items (Scale Models)

The unique platter design allows you to place items anywhere on its surface, including leaning atop its vertical section, to be weighed accurately. In addition, the Produce Rail™ allows items to rest above the counter and other non-weighing surfaces. See Figure 3.

Once weighed items have been positioned, enter PLU (price Look-Up) data as described in your POS system instructions. Item weight is displayed on the Remote Display and/or the host display.

Figure 3. Weighing Items

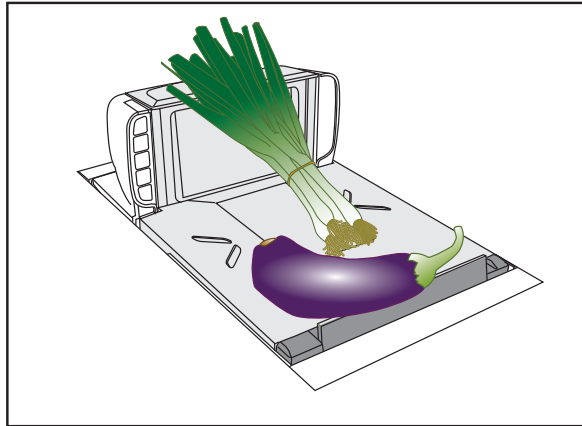

Scale Sentry™ Option

The optional ScaleSentry feature monitors items placed on the platter to detect and indicate if they are overhanging non-weighing surfaces. If the system's infrared (IR) beams sense items encroaching past the sides of the weigh platter at counter level or on the surface of the weigh platter, the speaker will sound a unique tone and/or the ScaleSentry LED indicator will illuminate to indicate a ScaleSentry error condition. A scale transaction cannot be completed until the item(s) are repositioned to rest fully on the platter (move them towards the center), clearing the condition. Reference the PRG for more ScaleSentry options and details.

Electronic Article Surveillance (EAS) Deactivation Options

Deactivation of Sensormatic®, Nedap® or Checkpoint® EAS tags is an optional function. The scanner must be expressly enabled to perform in either capacity.

Sensormatic Coupled Mode

When the scanner is configured to use Coupled EAS Deactivation Mode, deactivation of a given item happens automatically following its bar code being successfully read.

Sensormatic Decoupled Mode

When in Decoupled Mode, the sales associate must press the Manual EAS Deactivation button in order to deactivate an item. In this mode, deactivation is independent of the scanning function.

Sensormatic Hybrid Mode

When in Hybrid Mode, deactivation of a given item happens automatically following its bar code being successfully read, however, deactivation is independent of the scanning function.

Controls and Indicators

The scanner features a conspicuous green LED indicator bar atop the control panel side of its vertical “bonnet” (item #2 in Figure 4). Additionally, a configurable speaker is used to sound scanning, weighing and EAS deactivation indications, ScaleSentry event, etc.



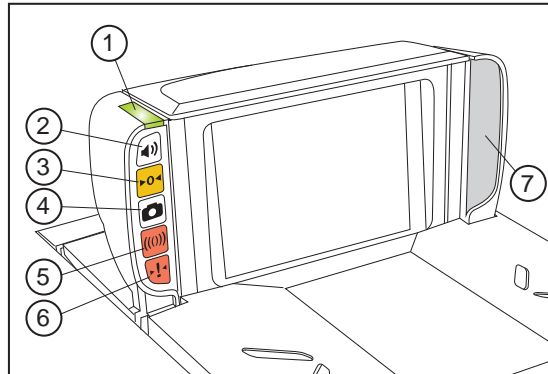



Figure 4. Top Side LED Indicators



1	LED Indicator “Bar”	5	Manual EAS Deactivation Button
2	Scanner Control Button ^b	6	Scale Sentry Override Button
3	Scale Zero Button	7	Speaker
4	Camera Button		

Table 1. Control Panel

See [LED and Beeper Indications](#) for more information regarding each of the indicators..

1	LED Indicator Bar  This bar lights/flashes to indicate functions such as a good read, ScaleSentry event, etc.	5	Manual EAS Deactivation Button  When in EAS Manual Deactivation Mode, push this button to deactivate an item. The LED illuminates to indicate EAS functions with red, green OR orange color.
2	Scanner Control Button  -If the scanner is ‘asleep”, press this button to wake it up. -Press this button momentarily to enter beeper volume change state. Select one of five volume settings. -Press this button between 1 and 4 seconds to enter beeper tone change state. -Press this button for 10 seconds to initiate a soft reset.	6	ScaleSentry Override Button  When configured to do so, a push of this button will override a detected scale overhang condition. This red LED indicates the current ScaleSentry condition. See the LED and Beeper Indications section for more information.
3	Scale Zero Button  With all weight removed from the scale, push this button to set the scale to zero. The yellow LED indicates scale functions.	7	Speaker  Sounds ^a beeps, error tones and other audible signals to indicate good read, ScaleSentry alert, system error and other conditions.
4	Image Capture Button  This button is used to capture images using the vertical window. See the PRG for more information.		

a. Some audible indications are configurable to be on or off, as well as offer their own programmable options for pitch, volume, etc.

b. Button functions may be disabled for some applications based on user requirements. See the programming section of the PRG for details.

Cleaning

Exterior surfaces and scan windows exposed to spills, smudges or debris accumulation require periodic cleaning to assure best performance during scanning and weighing operations. Use a clean, lint-free cloth or paper towel dampened with a nonabrasive, mild, water-based window cleaner to wipe away stains, smudges, fingerprints, spills, etc. from the scan window and exterior surfaces (Figure 5a).

Figure 5. Cleaning the Scanner

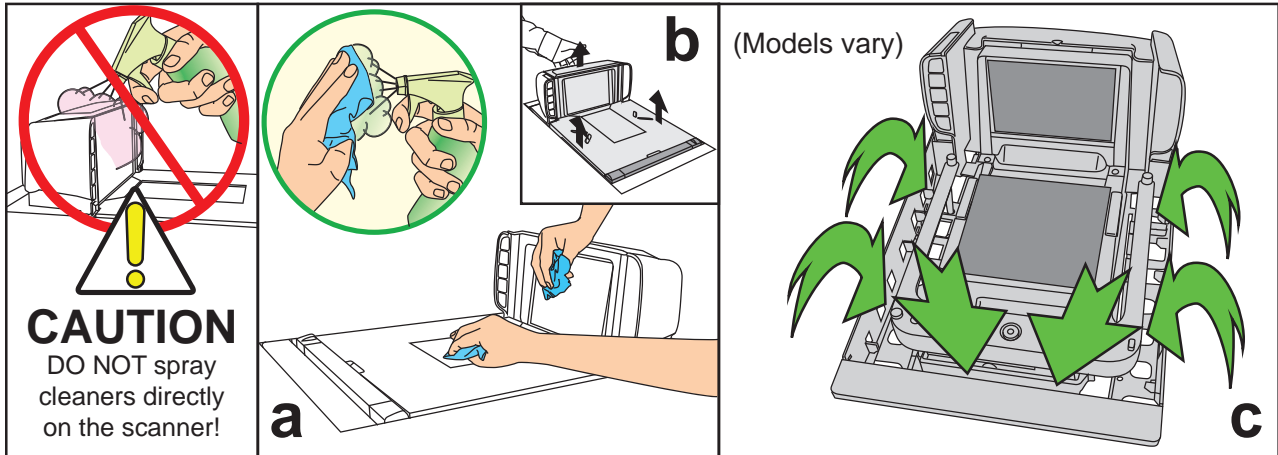

DO NOT use abrasive cleaning agents or abrasive pads to clean this product. Harsh chemicals, disinfectants, and cleansers can cause damage which will adversely affect scanning and weighing performance.

Daily, clean the debris chutes between the platter and the outer housing (Figure 5c). Most items can be cleared from the debris chutes by carefully running a thin, stiff object like a credit card along all sides of the weighing surface. If necessary, remove the platter (Figure 5b) to clean the debris chutes and drip rail.

CSS Option

Figure 6. Customer Service Scanner (CSS)

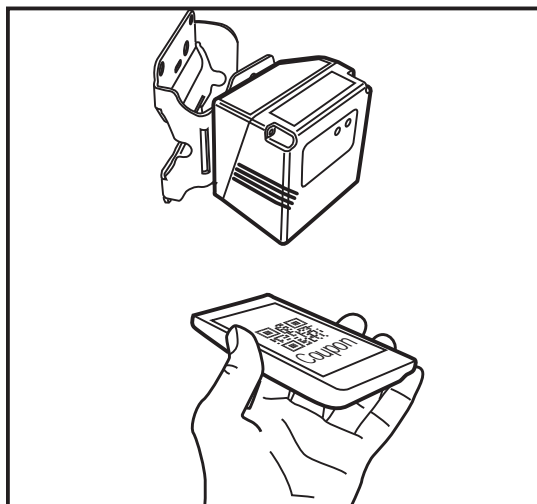

A Customer Service Scanner (CSS) can be teamed with the system which enables mobile commerce (see Figure 6). This unit can be positioned separately for optimal customer access. This eliminates the need for an additional scanner, power supply, outlet, interface cable, POS port and mounting hardware. The customer can scan bar codes from their mobile phone screen or paper coupons while the cashier continues to scan regular items in parallel.

LED and Beeper Indications

The scanner's beeper sounds and its lamps and indicator LEDs illuminate to indicate various functions or errors. The tables in this section list some of these indications. Reference the PRG for a more complete listing.



NOTE

Behaviors listed in the tables are programmable, and may or may not be turned on. For example, certain indications such as the power-up beep can be disabled using programming bar code labels.

INDICATION	Scanner LED	BEEPER				COMMENT
		Count	Frequency	Volume	Duration	
Pre-operating Mode	OFF	OFF				
Power-up Beep	N/A	Unique WAV file sound.				Default sound is a synthesized chord ending with two light bells.
Good Read Beep	Bright flash	1	Current	Current	Current	Frequency, volume and duration are configurable.
ROM Failure	200ms ON 200 ms OFF	1	Error	Highest	200ms ON 200ms OFF	Indicates either Boot or Program ROM failure.
Scanner Active Mode	On steady and dim	N/A				The scanner is ready for operation. Scanning is immediately available.
Scanner Disabled	Continuous blink 100ms ON / 900ms OFF	N/A				The Host has disabled scanning.
Sleep Mode	10ms ON 1990ms OFF	N/A				The scanner has been inactive for a period and is in a power-saving mode.
Chirp Indications (see comment)	N/A	6	Highest	Current	20ms ON 20ms OFF	A 'Chirp' is used to indicate the following: -Reading labels while in limited scanning mode. -Label rejection during label programming. -A label with no data. -Labels rejected through the auxiliary port when in Scanner Diagnostics Mode.
INDICATION	Scale LED	BEEPER				COMMENT
Scale at Zero	On steady	N/A				The scale is at rest and reads zero weight. The scale is ready to weigh.
Scale Error Reporting	Coded sequence	N/A				When the scanner is in Scale Diagnostics Mode, the Remote Scale Display and the Scale LED indicator can communicate specific scale failures. See the PRG for more details.

Error Codes

Upon startup, if the scanner sounds a long error tone followed by alternating flashing of the green and yellow LED indicators, and an error code is displayed on the Health & Status Indicator, this means the scanner has not passed its automatic Selftest and has entered FRU (Field Replaceable Unit) isolation mode. The scanner remains in this mode, until any button is pushed.

After a button is pushed, the scanner flashes the green LED a set number of times to indicate the error code. After one cycle of flashing has passed, another button push resets the scanner. The Product Reference Guide (PRG) describes the LED flash codes associated with an error found. If your scanner indicates any of these errors, note the code number, then contact Helpdesk for assistance.

ScaleSentry™ Indications

Flashing Red = ScaleSentry beam blocked.

Off = ScaleSentry beam is not blocked

Sensormatic® EAS Indications

If the scanner is equipped with the optional Sensormatic EAS option, various deactivation and validation indications will be enabled.

INDICATION	EAS LED	BEEPER				COMMENT
		Count	Frequency	Volume	Duration	
Entering EAS Coupled Mode	Green ON	N/A				
Upon sensing an inactive to active transition	Red ON Green OFF	N/A				While in EAS Coupled Mode.
Upon sensing an active to inactive transition	Red OFF Green ON	N/A				While in EAS Coupled Mode.
Upon receiving validation of EAS tag deactivation	Orange ON until EAS beeper turns OFF	1	~ 1500 Hz	Current	Configurable	While in EAS Coupled Mode.
EAS Bad Beep	N/A	Same as FRU error tone				While in EAS Coupled Mode.

Label Programming Mode Indications

These indications occur only when the scanner is in Programming Mode or when placing the scanner in that mode.

INDICATION	LED	BEEP(S)
Label Programming Mode Entry	Continuous blink 1 sec. ON / 1 sec. OFF	Same as good read indication
Acceptance of Partial Labels	N/A	1
Partial Label Reading Cancel	N/A	6
Acceptance of Complete Labels	N/A	3

Warranty

Datalogic warrants to Customer that this product will be free from defects in materials and workmanship for a period of 1 year from product shipment. Datalogic ADC Limited Factory Warranty

Warranty Coverage

Datalogic ADC ('Datalogic') hardware products are warranted against defects in material and workmanship under normal and proper use. The liability of Datalogic under this warranty is limited to furnishing the labor and parts necessary to remedy any defect covered by this warranty and restore the product to its normal operating condition. Repair or replacement of product during the warranty does not extend the original warranty term. Products are sold on the basis of specifications applicable at the time of manufacture and Datalogic has no obligation to modify or update products once sold.

If Datalogic determines that a product has defects in material or workmanship, Datalogic shall, at its sole option repair or replace the product without additional charge for parts and labor, or credit or refund the defective products duly returned to Datalogic. To perform repairs, Datalogic may use new or reconditioned parts, components, subassemblies or products that have been tested as meeting applicable specifications for equivalent new material and products. Customer will allow Datalogic to scrap all parts removed from the repaired product. The warranty period shall extend from the date of shipment from Datalogic for the duration published by Datalogic for the product at the time of purchase (Warranty period). Datalogic warrants repaired hardware devices against defects in workmanship and materials on the repaired assembly for a 90 day period starting from the date of shipment of the repaired product from Datalogic or until the expiration of the original warranty period, whichever is longer. Datalogic does not guarantee, and it is not responsible for, the maintenance of, damage to, or loss of configurations, data, and applications on the repaired units and at its sole discretion can return the units in the 'factory default' configuration or with any software or firmware update available at the time of the repair (other than the firmware or software installed during the manufacture of the product). Customer accepts responsibility to maintain a back up copy of its software and data.

Warranty Claims Process

In order to obtain service under the Factory Warranty, Customer must notify Datalogic of the claimed defect before the expiration of the applicable Warranty period and obtain from Datalogic a return authorization number (RMA) for return of the product to a designated Datalogic service center. If Datalogic determines Customer's claim is valid, Datalogic will repair or replace product without additional charge for parts and labor. Customer shall be responsible for packaging and shipping the product to the designated Datalogic service center, with shipping charges prepaid. Datalogic shall pay for the return of the product to Customer if the shipment is to a location within the country in which the Datalogic service center is located. Customer shall be responsible for paying all shipping charges, duties, taxes, and any other charges for products returned to any other locations. Failure to follow the applicable RMA policy, may result in a processing fee. Customer shall be responsible for return shipment expenses for products which Datalogic, at its sole discretion, determines are not defective or eligible for warranty repair.

Warranty Exclusions

The Datalogic Factory Warranty shall not apply to:

-
- (i) any product which has been damaged, modified, altered, repaired or upgraded by other than Datalogic service personnel or its authorized representatives;
 - (ii) any claimed defect, failure or damage which Datalogic determines was caused by faulty operations, improper use, abuse, misuse, wear and tear, negligence, improper storage or use of parts or accessories not approved or supplied by Datalogic;
 - (iii) any claimed defect or damage caused by the use of product with any other instrument, equipment or apparatus;
 - (iv) any claimed defect or damage caused by the failure to provide proper maintenance, including but not limited to cleaning the upper window in accordance with product manual;
 - (v) any defect or damage caused by natural or man-made disaster such as but not limited to fire, water damage, floods, other natural disasters, vandalism or abusive events that would cause internal and external component damage or destruction of the whole unit, consumable items;
 - (vi) any damage or malfunctioning caused by non-restoring action as for example firmware or software upgrades, software or hardware reconfigurations etc.;
 - (vii) the replacement of upper window/cartridge due to scratching, stains or other degradation and/or
 - (viii) any consumable or equivalent (e.g., cables, power supply, batteries, keypads, touch screen, triggers etc.).

No Assignment

Customer may not assign or otherwise transfer its rights or obligations under this warranty except to a purchaser or transferee of product. No attempted assignment or transfer in violation of this provision shall be valid or binding upon Datalogic.

DATALOGIC'S LIMITED WARRANTY IS IN LIEU OF ALL OTHER WARRANTIES, EXPRESS OR IMPLIED, ORAL OR WRITTEN, STATUTORY OR OTHERWISE, INCLUDING, WITHOUT LIMITATION, ANY IMPLIED WARRANTIES OF MERCHANTABILITY, FITNESS FOR A PARTICULAR PURPOSE, OR NONINFRINGEMENT. DATALOGIC SHALL NOT BE LIABLE FOR ANY DAMAGES SUSTAINED BY CUSTOMER ARISING FROM DELAYS IN THE REPLACEMENT OR REPAIR OF PRODUCTS UNDER THE ABOVE. THE REMEDY SET FORTH IN THIS WARRANTY STATEMENT IS THE CUSTOMER'S SOLE AND EXCLUSIVE REMEDY FOR WARRANTY CLAIMS. UNDER NO CIRCUMSTANCES WILL DATALOGIC BE LIABLE TO CUSTOMER OR ANY THIRD PARTY FOR ANY LOST PROFITS, OR ANY INCIDENTAL, CONSEQUENTIAL IN-DIRECT, SPECIAL OR CONTINGENT DAMAGES REGARDLESS OF WHETHER DATALOGIC HAD ADVANCE NOTICE OF THE POSSIBILITY OF SUCH DAMAGES.

Risk of Loss

Customer shall bear risk of loss or damage for product in transit to Datalogic. Datalogic shall assume risk of loss or damage for product in Datalogic's possession. In the absence of specific written instructions for the return of product to Customer, Datalogic will select the carrier, but Datalogic shall not thereby assume any liability in connection with the return shipment.



www.datalogic.com

©2014-2015 Datalogic ADC, Inc., Inc. All rights reserved.
Datalogic and the Datalogic logo are registered trademarks of Datalogic S.p.A. in many countries, including the U.S.A. and the E.U.

Datalogic ADC, Inc.

959 Terry Street | Eugene | OR 97402 | USA

Telephone: (1) 541-683-5700 | Fax: (1) 541-345-7140

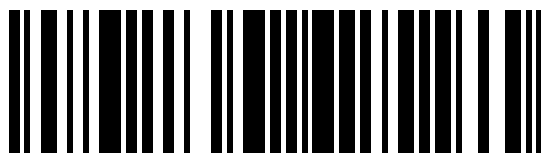

820073914

(Rev. A)

April 2015