

PowerScan® BT8300 Family

Industrial Handheld Bar Code Reader
with Bluetooth® Wireless Technology



Product Reference Guide

Datalogic Scanning, Inc.

959 Terry Street
Eugene, Oregon 97402
USA
Telephone: (541) 683-5700
Fax: (541) 345-7140

An Unpublished Work - All rights reserved. No part of the contents of this documentation or the procedures described therein may be reproduced or transmitted in any form or by any means without prior written permission of Datalogic Scanning, Inc. or its subsidiaries or affiliates ("Datalogic" or "Datalogic Scanning"). Owners of Datalogic products are hereby granted a non-exclusive, revocable license to reproduce and transmit this documentation for the purchaser's own internal business purposes. Purchaser shall not remove or alter any proprietary notices, including copyright notices, contained in this documentation and shall ensure that all notices appear on any reproductions of the documentation.

Should future revisions of this manual be published, you can acquire printed versions by contacting your Datalogic representative. Electronic versions may either be downloadable from the Datalogic website (www.scanning.datalogic.com) or provided on appropriate media. If you visit our website and would like to make comments or suggestions about this or other Datalogic publications, please let us know via the "Contact Datalogic" page.

Disclaimer

Datalogic has taken reasonable measures to provide information in this manual that is complete and accurate, however, Datalogic reserves the right to change any specification at any time without prior notice.

Datalogic and the Datalogic logo are registered trademarks of Datalogic S.p.A. in many countries, including the U.S.A and the E.U. All other brand and product names referred to herein may be trademarks of their respective owners.

Microsoft Windows®, Windows® XP and the Windows logo are registered trademarks of Microsoft Corporation.

Patents

This product is covered by one or more of the following patents.

Design Pat. AU 310201; AU 310202; CN 693980; CN735959; HK 0602013.5M001; HK 0602013.5M002; JP 1305693; KR 30-0460940; US D570,843 S; USD588,596 S.

US Pat. 5,992,740; 6,305,606 B1; 6,517,003; 6,808,114 B1; 6,997,385 B2; 7,387,246 B2; 5,367,151; 5,449,893; 5,545,889; 6,098,877; 6,220,514 B1; 6,412,698 B2; 6,607,132 B1; 6,817,529 B2; 6,834,805 B2; 7,948,214 B2.

European Pat. 789,315 B1; 895,175 B1; 1,128,314 B1; 1,128,315 B1; 1,396,811 B1; 1,413,971 B1; 1,816,585 B1; 1,942,442 B1.

Additional patents pending.

CONTENTS

1	INTRODUCTION	1
2	INSTALLATION	1
2.1	BC 8030-BT Interface Cable Connections	1
2.2	RS-232 Connection	2
2.3	USB	2
2.4	IBM USB POS	2
2.5	WEDGE Connection	2
2.6	PEN Emulation Connection	2
2.7	PowerScan™ BT8300 Battery Maintenance	3
2.7.1	Battery Safety	3
2.7.2	Battery Charging	4
2.7.3	Replacing PowerScan™ BT8300 Batteries	4
2.8	Mounting The BC 8030-BT Cradle	5
2.8.1	Desktop Mounting	6
2.8.2	Wall Mounting	8
3	POWERSCAN™ BT8300 SYSTEM	10
3.1	POWERSCAN™ BT8300/BC 8030-BT	10
3.2	POWERSCAN™ BT8300/BLUETOOTH-ENABLED PC	10
4	CONFIGURATION	11
4.1	Configuration Methods	11
4.1.1	Reading Configuration Barcodes	11
4.1.2	Using Datalogic Aladdin™	11
4.1.3	Copy Command	11
4.1.4	Sending Configuration Strings from Host	11
4.2	Setup Procedures	11
4.2.1	Restore PowerScan BT 8300 Default	11
4.3	Connecting the PowerScan BT8300	12
4.3.1	Overview	12
	PowerScan™ BT8300/BC 8030-BT Configuration	12
	PowerScan™ BT8300/Bluetooth-Enabled PC Configuration	12
4.3.2	Before You Begin	12
4.4	Interface Selection	19
4.5	USB Reader Configuration	21
4.6	Changing Default Settings	22
	RS-232 PARAMETERS	23
	USB PARAMETERS	26
	WEDGE PARAMETERS	31
	PEN EMULATION	36
	DATA FORMAT	41
	POWER SAVE	55
	READING PARAMETERS	57
	DECODING PARAMETERS	62
	CODE SELECTION	65
	ADVANCED FORMATTING	79
	RADIO PARAMETERS	95
	BLUETOOTH PARAMETERS	98
	DISPLAY and KEYPAD PARAMETERS (3-Key Model)	108
	DISPLAY and KEYPAD PARAMETERS (16-Key Model)	112
5	REFERENCES	127
5.1	RS-232 Parameters	127
5.1.1	Handshaking	127
5.2	Pen Parameters	128
5.2.1	Minimum Output Pulse	128
5.2.2	Conversion to Code 39 and Code 128	128
5.2.3	Overflow	128
5.2.4	Output and Idle Levels	129
5.2.5	Inter-Block Delay	129
5.3	Data Format	130
5.3.1	Header/Terminator Selection	130
5.3.2	Define Special Key Sequence	131
5.3.3	Address Stamping	137
5.3.4	Address Delimiter	137

CONTENTS

5.3.5	Time Stamping Format	137
5.3.6	Time Stamping Delimiter	137
5.4	Power Save	138
5.4.1	Sleep State	138
5.4.2	Enter Sleep Timeout	138
5.5	Reading Parameters	138
5.5.1	Trigger Signal	138
5.5.2	Trigger Click	138
5.5.3	Trigger-Off Timeout	138
5.5.4	Reads per Cycle	138
5.5.5	Safety Time	139
5.6	Decoding Parameters	139
5.6.1	Ink-Spread	139
5.6.2	Overflow Control	139
5.6.3	Interdigit Control	139
5.7	Advanced Formatting	139
5.7.1	Match Conditions	139
5.8	Radio Parameters	140
5.8.1	Power-Off Timeout	140
5.8.2	Beeper Control for Radio Response	140
5.8.3	Batch Mode	140
5.8.4	See Me	141
5.9	BLUETOOTH PARAMETERS	142
5.9.1	Communication Type	142
5.9.2	Link By Contact	142
5.9.3	Link By Label	142
5.9.4	Start Up Connect	143
5.9.5	Auto Reconnect	143
5.9.6	Reconnect Attempt Interval	143
5.9.7	Reconnect Attempt Mode	143
5.9.8	Power Class	143
5.9.9	Security Mode	144
5.9.10	PIN Code & PIN Length	144
5.9.11	Variable PIN Code	144
5.9.12	HID Caps Lock Auto-Recognition (IBM AT-Compatible Only)	144
5.9.13	HID Alt Mode	144
5.9.14	HID Interchar Delay	145
5.9.15	HID Send Unknown ASCII Character	145
5.10	Display Parameters (Some BT8300 Models only)	145
5.10.1	Display Mode	145
5.11	Configuration Editing Commands	146
5.12	Custom Default Configuration	146
5.13	Code Type Recognition	147
5.14	Configuration Copying Commands	147
5.14.1	Copy PowerScan™ BT8300 Series	147
5.14.2	Copy BC 8030-BT	148
5.15	Default Parameters for POS Terminals	149
5.16	Firmware Upgrade	150
5.17	16-Key PowerScan BT8300-DK Display and Keypad Parameters	150
5.17.1	16-key Keyboard Data Format Enable/Disable	150
5.17.2	Scanner Code ID	151
5.17.3	Scanner Code Length	151
6	MESSAGE FORMATTING	152
6.1	Standard Message Formatting	152
6.2	Advanced Message Formatting	152
6.3	Messages from SCANNER Command Keys	153
6.3.1	PowerScan BT8300 keypad	153
7	TECHNICAL FEATURES	155
7.1	PowerScan™ BT8300	155
7.2	BC 8030-BT	156
7.3	System CONFIGURATION	157
7.4	Status Indicators	157
7.5	Reading Diagrams	159

GENERAL VIEW



Figure A – PowerScan™ BT8300 Series Readers

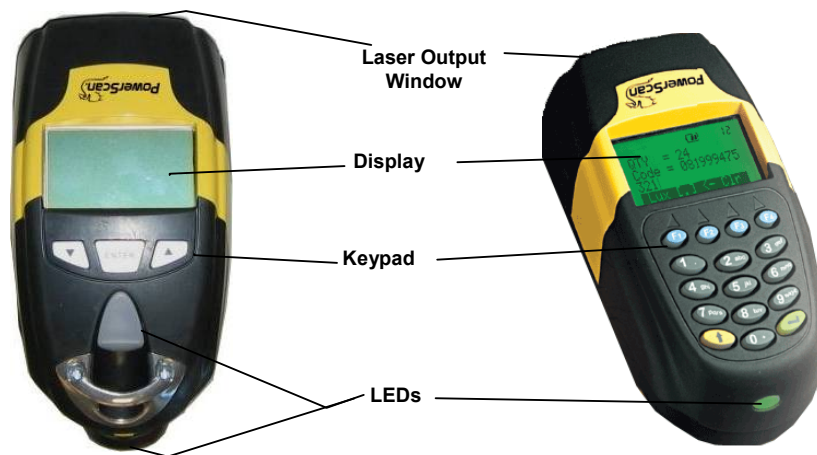

Figure B – PowerScan™ BT8300 Series Readers with Display

BC 8030-BT CRADLE

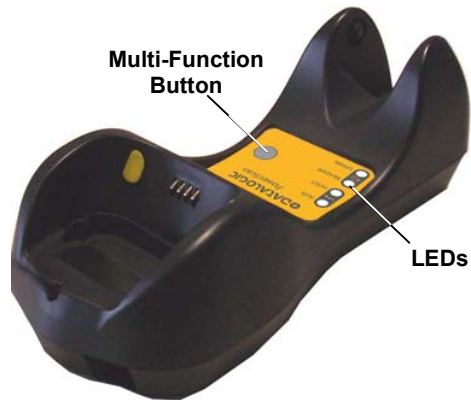

Figure C – BC 8030-BT

The label on the cradle contains LED indicators and a multi-function button. When the button is pressed for less than 8 seconds, the cradle will act in one of two ways:

1. If not already paired with a BT8300, it will start to search for all "discoverable" BT8300 scanners in radio range; this procedure allows a link with a maximum of four PowerScan BT8300 readers

OR

2. If it already has a connection with at least one PowerScan BT8300 reader, it will transmit a "broadcast" message." When the broadcast is sent, all properly configured scanners that are linked to that base and within radio range coverage will emit a beep and blink within 5 seconds.

This functionality is useful to:

- verify which scanners are linked to a certain base station
- detect a scanner forgotten somewhere

When the button is pressed for longer than 8 seconds, all paired scanners will be unpaired.

1 INTRODUCTION

Datalogic renews its range of industrial laser scanners introducing the **PowerScan™ BT8300** family. Robustness and ergonomics remain unsurpassed: clearly audible beeper and bright "good read" LEDs for areas where noise levels are normally high; the aim mode, which helps point to the right code, has now been extended to the whole **PowerScan™** family. Optical parts are completely suspended on shock absorbers and a careful choice of the body materials, such as the co-moulded rubber, protect the **PowerScan™** from damage due to "falls".

New enhanced architecture, based on an M16 high-speed microprocessor, enables exceptional performance for promptness and reading speed of standard codes as well as the ability to read poorly printed and damaged codes. Puzzle Solver Technology™, a patent from Datalogic, adds further strength to the **PowerScan™** powerful engine.

In all applications where mobility is a value, the new **PowerScan™ BT8300** represents the key to increase productivity and flexibility in the working area. **PowerScan™ BT8300** communicates through a low power, license free radio in the 2.4 GHz band (Bluetooth®) and allows bi-directional communication between the base station and the host. **PowerScan™ BT8300** also includes a display and either a 3 or 16-key push-button keypad. Thanks to these features, the operator can type unreadable codes or additional information (like quantity) and visualize the code read. The cordless system offers scalable solutions to solve simple applications and complex projects:

- PowerScan BT8300/BC 8030-BT: up to four readers can transmit data to one base station
- PowerScan BT8300/Bluetooth-Enabled PC: up to 7 readers can connect with the Host.

Your **PowerScan™** reader is supplied with its own Quick Reference Guide, which provides connection, diagrams, reading diagrams, basic application parameter settings, default values, and specific technical features. You can use either the Quick Reference Guide or this Manual for initial configuration in order to set the default values and select the interface for your application. This manual provides all the necessary information for complete mechanical installation and system software configuration.

2 INSTALLATION

2.1 BC 8030-BT Interface Cable Connections

The BC 8030-BT incorporates a multi-standard interface, which can be connected to a Host by simply plugging the correct interface cable into the Host connector, placed on the base of the cradle. In addition the cradle must be connected to an external power supply.



To disconnect the cable, insert a paper clip or other similar object into the hole corresponding to the Host connector on the body of the cradle. Push down on the clip while unplugging the cable.

2.2 RS-232 Connection

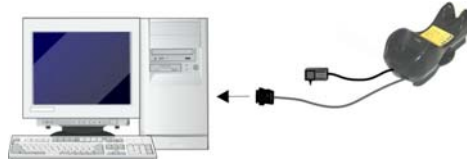

2.3 USB

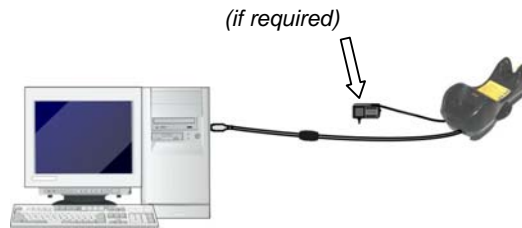

2.4 IBM USB POS

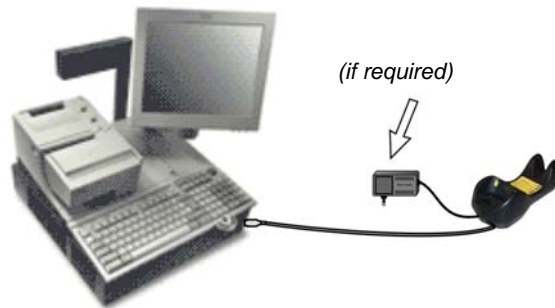

2.5 WEDGE Connection

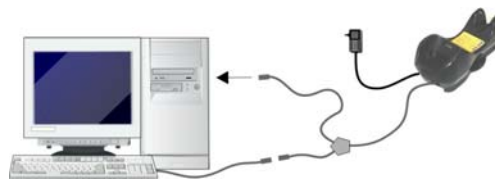

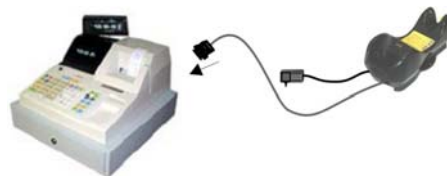

2.6 PEN Emulation Connection



2.7 PowerScan™ BT8300 Battery Maintenance

 NOTE	<p>Before installing the Battery, read “Battery Safety” on this and the following pages. Datalogic recommends annual replacement of rechargeable battery packs to ensure maximum performance.</p>
--	---

2.7.1 Battery Safety

 WARNING	<p>Do not discharge the battery using any device except the scanner. When the battery is used in devices other than the designated product, it may damage the battery or reduce its life expectancy. If the device causes an abnormal current to flow, it may cause the battery to become hot, explode or ignite and cause serious injury. Lithium-ion battery packs may get hot, explode or ignite and cause serious injury if exposed to abusive conditions. Be sure to follow the safety warnings listed below:</p>
 WARNING	<p>Do not place the battery pack in fire or heat. Do not connect the positive terminal and negative terminal of the battery pack to each other with any metal object (such as wire). Do not carry or store the battery pack together with metal objects. Do not pierce the battery pack with nails, strike it with a hammer, step on it or otherwise subject it to strong impacts or shocks. Do not solder directly onto the battery pack. Do not expose the battery pack to liquids, or allow the battery to get wet. Do not apply voltages to the battery pack contacts. In the event the battery pack leaks and the fluid gets into your eye, do not rub the eye. Rinse well with water and immediately seek medical care. If left untreated, the battery fluid could cause damage to the eye.</p>
 CAUTION	<p>Always charge the battery at 32° – 104°F (0° - 40°C) temperature range. Use only the authorized power supplies, battery pack, chargers, and docks supplied by your Datalogic reseller. The use of any other power supplies can damage the device and void your warranty. Do not disassemble or modify the battery. The battery contains safety and protection devices, which, if damaged, may cause the battery to generate heat, explode or ignite. Do not place the battery in or near fire, on stoves or other high temperature locations. Do not place the battery in direct sunlight, or use or store the battery inside cars in hot weather. Doing so may cause the battery to generate heat, explode or ignite. Using the battery in this manner may also result in a loss of performance and a shortened life expectancy. Do not place the battery in microwave ovens, high-pressure containers or on induction cookware. Immediately discontinue use of the battery if, while using, charging or storing the battery, the battery emits an unusual smell, feels hot, changes color or shape, or appears abnormal in any other way. Do not replace the battery pack when the device is turned on. Do not remove or damage the battery pack’s label. Do not use the battery pack if it is damaged in any part. Battery pack usage by children should be supervised.</p>

As with other types of batteries, Lithium-Ion (LI) batteries will lose capacity over time. Capacity deterioration is noticeable after one year of service whether the battery is in use or not. It is difficult to precisely predict the finite life of a LI battery, but cell manufacturers rate them at 500 charge cycles. In other words, the batteries should be expected to take 500 full discharge / charge cycles before needing replacement. This number is higher if partial discharging / recharging is adhered to rather than full / deep discharging.

The typical manufacturer advertised useful life of LI batteries is one to three years, depending on usage and number of charges, etc., after which they should be removed from service, especially in mission critical applications. Do not continue to use a battery that is showing excessive loss of capacity, it should be properly recycled / disposed of and replaced. For most applications, batteries should be replaced after one year of service to maintain customer satisfaction and minimize safety concerns.

Collect and recycle waste batteries separately from the device in compliance with European Directive 2006/66/EC, 2002/95/EC, 2002/96/EC and subsequent modifications, US and China regulatory and others laws and regulations about the environment.

2.7.2 Battery Charging

Once the system is connected and powered, place the PowerScan™ BT8300 into the cradle to charge the battery. When the reader is correctly inserted in the cradle, the "Reader" red LED on the cradle goes on to indicate that the battery is charging. The "Reader" green LED on the cradle goes on when the battery is completely charged.

2.7.3 Replacing PowerScan™ BT8300 Batteries

To change the batteries in your PowerScan™ BT8300 scanner, press the black button or unscrew the fixing screw on the handle cover and extract the battery pack from the reader handle.

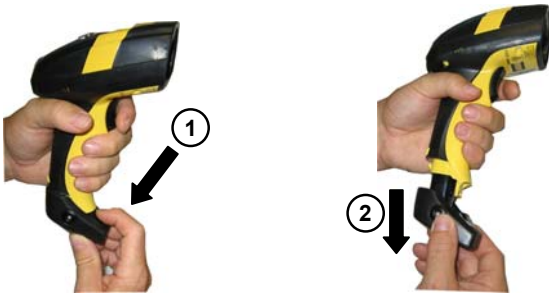

	<p>When the batteries are extracted from the scanner, the timer maintains the current hour and date for about 1 minute.</p>
<p>NOTE</p>	

Replace the old battery pack with a new one by inserting it within the reader handle and pushing it until it clicks.

	<p>Do not incinerate, disassemble, short terminals or expose to high temperature. Risk of fire, explosion. Use specified charger only. Risk of explosion if the battery is replaced by an incorrect type. Dispose of the batteries as required by the relevant laws in force. See "Battery Safety" on the previous pages.</p>
<p>WARNING</p>	

2.8 Mounting The BC 8030-BT Cradle

The cradle package contains the following items:

- BC 8030-BT Cradle
- BC 8030-BT Quick Reference Guide
- 2 adhesive strips
- 2 wall-mounting lock hinges
- 1 horizontal base
- 1 inclined base

The cradle (BC 8030-BT) can be mounted for portable or fixed desktop usage, or it can be fixed to a wall. The horizontal base allows portable and fixed desktop usage, while the inclined base provides desktop and wall mounting guaranteeing a comfortable handling of the PowerScan™ BT8300 reader.



BC 8030-BT Cradle mounted on the Horizontal Base



BC 8030-BT Cradle mounted on the Inclined Base

2.8.1 Desktop Mounting

For desktop usage, you can mount the cradle either on the horizontal base, for reduced overall dimensions, or on the inclined base for a more ergonomic taking out and insertion of the reader onto the cradle.

Horizontal base

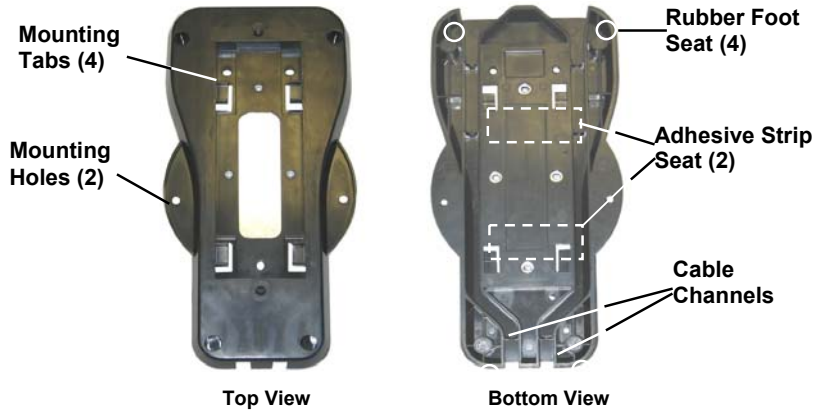

Inclined base

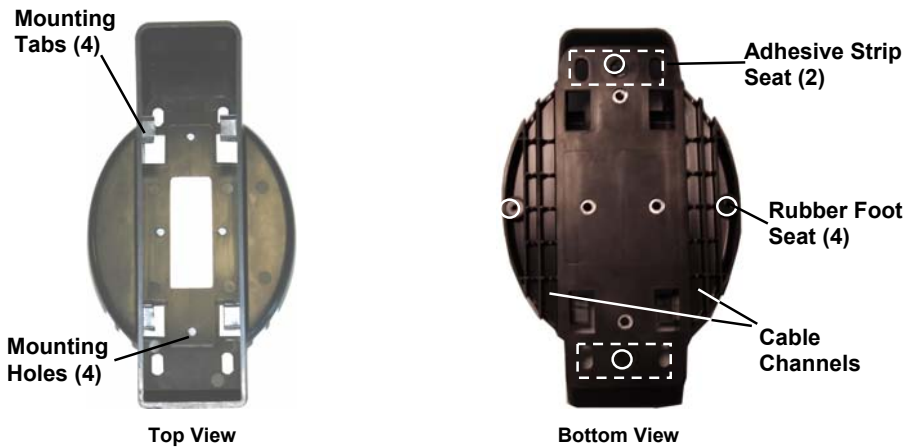

Portable Desktop Use

1. Correctly position the BC 8030-BT onto the base by sliding it along the mounting tabs until aligned.



2. Carefully clean the rubber foot seats of the base to remove any impurities that could reduce adhesion.
3. Remove the protective plastic from the rubber feet and stick them onto the bottom surface of the base.
4. If mounting the BC 8030-BT cradle, insert the antenna in the appropriate hole on the body of the cradle and screw it clockwise until tight.

Fixed Desktop Use

For fixed desktop installation, use the adhesive strips or fixing screws (not provided) according to your needs.

For mounting with adhesive strips:

1. Position the cradle onto the base by sliding it along the mounting tabs until aligned.
2. Carefully clean the adhesive strip seats of the base to remove any impurities that could reduce adhesion.
3. Remove the protective plastic from one side of the adhesive strips and stick them onto the base surface.
4. Position the cables to be connected to the BC 8030-BT cradle along the dedicated channels, as shown in the figures below:



Horizontal Base



Inclined Base

5. Remove the plastic from the other side of the strips and affix the base to the table.
6. If mounting the BC 8030-BT cradle, insert the antenna in the appropriate hole on the body of the cradle and screw it clockwise until tight.

For mounting with screws:

1. Position the cables to be connected to the BC 8030-BT cradle along the dedicated channels, as shown in the figures below:
2. Position the base on the table and affix it by means of the screws (not provided).
3. Position the cradle on the base by sliding it along the mounting tabs until aligned.
4. If mounting the BC 8030-BT cradle, insert the antenna in the appropriate hole on the body of the cradle and screw it clockwise until tight.

2.8.2 Wall Mounting



Remove the yellow caps and insert the two wall mounting lock hinges provided with your cradle.

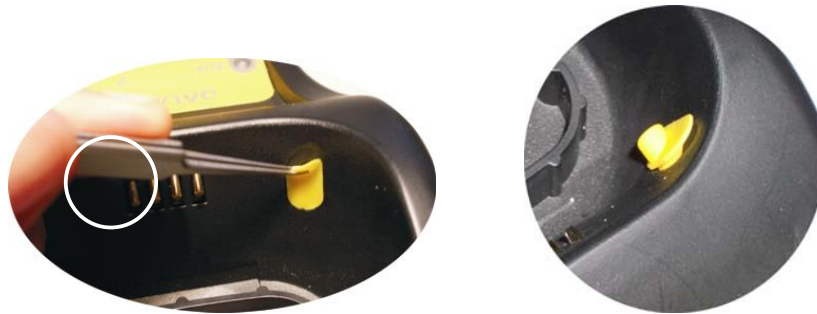

1. Position the cables to be connected to the BC 8030-BT cradle along the dedicated channels (see figures on page 7).

If using the adhesive strips:

- a. Carefully clean the adhesive strip seats of the base to remove any impurities that could reduce adhesion.
- b. Remove the protective plastic from one side of the adhesive strips and stick them onto the base surface.
- c. Remove the plastic from the other side of the strips and affix the base to the wall as indicated in the figure below.

If using the mounting screws:

- a. Using the mounting holes on the base as a pattern, mark the wall where you desire to mount the BC 8030-BT.
- b. Drill the appropriate size holes and insert the threaded dowels (not provided) into the holes.
- c. Position the base on the wall as indicated in the figure below and affix it by means of the screws (not provided).



Inclined Base Wall-mounting

2. Attach the cradle on the base by sliding it along the mounting tabs until aligned.
3. If mounting the BC 8030-BT cradle, insert the antenna in the appropriate hole on the body of the cradle and screw it clockwise until tight.

3 POWERSCAN™ BT8300 SYSTEM

There are two basic system layouts that can be employed:

- PowerScan BT8300/BC 8030-BT
- PowerScan BT8300/Bluetooth-Enabled PC

3.1 POWERSCAN™ BT8300/BC 8030-BT

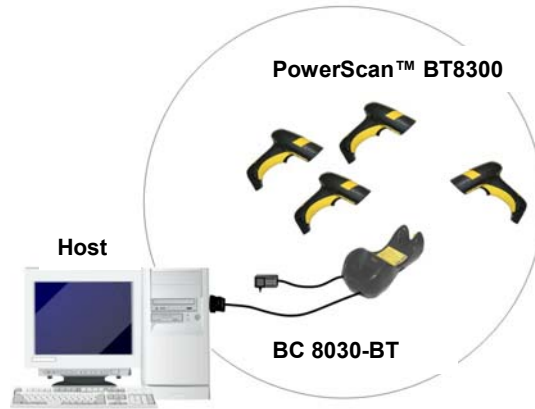

3.2 POWERSCAN™ BT8300/BLUETOOTH-ENABLED PC

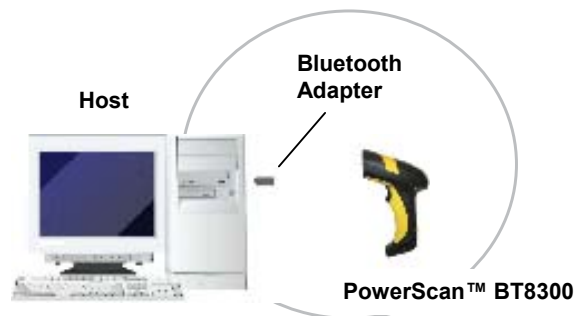

4 CONFIGURATION

4.1 Configuration Methods

4.1.1 Reading Configuration Barcodes

This manual can be used for complete setup and configuration of your reader by following the setup procedures in this chapter (see par. 4.2 for an overview).

If you wish to change the default settings, this manual provides complete configuration of your reader in an easy way.

To configure your reader:

1. Open the folded page in [Appendix C](#) with the hex-numeric table and keep it open during the device configuration.
2. Read the **Enter Configuration** code ONCE, available at the top of each page of configuration.
3. Modify the desired parameters in one or more sections following the procedures given for each group.
4. Read the **Exit and Save Configuration** code ONCE, available at the top of each page of configuration.

Reference notes describing the operation of the more complex parameters are given in chapter 1.

4.1.2 Using Datalogic Aladdin™

Datalogic Aladdin™ is a multi-platform utility program providing a quick and user-friendly configuration method via the RS-232/USB-COM interface.

It also allows upgrading the software of the connected device (see the Datalogic Aladdin™ Help On-Line for more details).

4.1.3 Copy Command

A previously configured device (Master), can be used to send its configuration directly to other devices of the same type (Slaves). The particular procedure for each device is given in par. 5.14.

4.1.4 Sending Configuration Strings from Host

An alternative configuration method is provided in Appendix A using the RS-232 interface. This method is particularly useful when many devices need to be configured with the same settings. Batch files containing the desired parameter settings can be prepared to configure devices quickly and easily.

4.2 Setup Procedures

4.2.1 Restore PowerScan BT 8300 Default

Before starting configuration and every time you want to restore factory settings, read the label below. Please note that the default mode on PowerScan BT8300 is Handheld - Cradle communication:

Restore PowerScan BT8300 Default



4.3 Connecting the PowerScan BT8300

4.3.1 Overview

PowerScan™ BT8300/BC 8030-BT Configuration

1. Connect a BC 8030-BT cradle to the Host. For installation and connection information see the BC 8030-BT Quick Reference Guide.
2. Charge the PowerScan BT8300 battery using a BC 8030-BT, the CHR-PM80 or BC-P080 chargers as described in the BT8300 Quick Reference Guide. A full charge takes 4 hours if using an external power supply; while it takes up to 10 hours if supplying power through the USB port.
3. Configure the reader as described in this manual or the BT8300 Quick Reference Guide.
4. Configure the BC 8030-BT cradle. See BC 8030-BT Configuration in the BC 8030-BT Quick Reference Guide.

- OR -

PowerScan™ BT8300/Bluetooth-Enabled PC Configuration

1. Install any drivers provided with the Bluetooth adapter.
2. Charge the PowerScan™ BT8300 battery using a BC-8030-BT, the CHR-PM80 or the MC-P080 chargers as described in this Quick Reference Guide. A full charge takes 4 hours if using an external power supply; while it takes up to 10 hours if supplying power through the USB port.
3. Configure the reader as described in this manual or the BT8300 Quick Reference Guide.

4.3.2 Before You Begin

In order to use the connection procedures below, the handheld and base station must be in an UNPAIRED state. If the reader is connected to a device, you must follow the procedure below to UNPAIR the Base Station and the handheld before attempting to link to a new device. If the handheld is not already connected to another device, then you can skip this step and go straight to the Linking instructions that begin on the next page.

Unpairing the Reader

To unpair the PowerScan BT8300 reader from a BC 8030-BT base station, press and hold the button on the BC 8030-BT (>8 seconds), then read the Unpair bar code below with each PowerScan BT8300 which you want to unpair from the cradle.

Unpair



You can Unpair the PowerScan BT8300 reader from a Bluetooth-Enabled PC to make it available for pairing with another PC. Read the bar code above to disconnect the reader from its PC.

Please note that in order to connect different scanners to a Base that is already connected to the maximum four scanners, you must follow the procedure above.

Linking the PowerScan™ BT8300 to the BC 8030-BT Cradle

The PowerScan BT 8300 reader can be connected with the PowerScan BC 8030-BT cradle in either of three ways. After the BC-8030-BT cradle is powered on and connected to the Host, configure the Power Scan BT8300 by reading the following bar codes in the given sequence as described in each section.



NOTE

Remember: The mandatory condition for establishing a new connection between a BT reader and a BT cradle is that they share the same security configuration. The connection timeout is 30 seconds. Four ascending beeps from the reader indicate a successful link, otherwise there are four descending tones.

Link by Contact

Read the bar codes in sequence as shown in the steps below:

1. 
2. 
3. 
4. 

5. Firmly position the reader onto the cradle. The BC 8030-BT cradle will emit a beep and the yellow LED will blink while the cradle is trying to establish the connection. Four ascending beeps will be emitted, signaling that the BC 8030-BT cradle has been successfully connected to the PowerScan BT8300, and the yellow LED on the cradle will stop blinking.
6. To connect another PowerScan PBT8300 to the BC 8030-BT cradle, repeat the sequence from steps 1 through 5. One Cradle can connect with a maximum of four readers.
7. Upon completing the connection between the reader and cradle you must set up the correct interface for your system. Refer to the BC 8030-BT Base Station Charger QRG for information and programming labels, and scan the appropriate bar code to select your system's interface type.

END of procedure. YOUR READER IS NOW READY TO READ CODES.

Link by Inquiry

1.

Enter Configuration



2.

Handheld - Cradle



3.

Exit and Save Configuration



4. To connect another PowerScan PBT8300 to the BC 8030-BT cradle, repeat in the sequence from steps 1 through 3 before continuing. One Cradle can connect with a maximum of four readers.

5. Quickly press the button (<8 seconds and release) on the BC 8030-BT cradle. The yellow LED on the cradle will blink and it will search for any PowerScan BT 8300 readers in radio range. After finishing, the cradle will emit a beep and begin to link with PowerScan BT8300 readers found.



6. The green LED on each PowerScan BT8300 reader will blink when the BC 8030-BT cradle tries to link with it. To confirm the connection with the cradle, press the trigger on the reader within 10 seconds, before the timeout expires.

7. Four ascending beeps will be emitted, signaling that the BC 8030-BT cradle has been successfully connected to the PowerScan BT8300, and the green LED on the reader will stop blinking.

8. Upon completing the connection between the reader and cradle you must set up the correct interface for your system. Refer to the BC 8030-BT Base Station Charger QRG for information and programming labels, and scan the appropriate bar code to select your system's interface type.

END of procedure. YOUR READER IS NOW READY TO READ CODES.

Link by Label

1.  Enter Configuration
2.  Handheld - Cradle
3.  Cradle Address
4.

+

Read 12 characters to represent Cradle Bluetooth Address
5.  Exit and Save Configuration
6. Four ascending beeps will be emitted, signaling that the PowerScan BT8300 has been successfully connected to the BC 8030-BT Cradle and the Green LED

END of procedure. YOUR READER IS NOW READY TO READ CODES.



NOTE *Another way to link the PowerScan™ BT8300 to the BC 8030-BT Cradle with the Link by Label method can be to create a label that includes the appropriate command and the cradle MAC address. Please refer to the Bluetooth Parameters Reference in this Product Reference Guide (PRG), or contact Technical Support for more information.*

Linking the PowerScan BT8300 to a Bluetooth-Enabled PC

The PowerScan BT8300 reader can optionally be linked to a Bluetooth-enabled host with the serial port profile (SPP) or human interface device (HID) as a virtual keyboard.





NOTE *Depending on the driver used by your device, specific actions may be required the first time a connection is made between the PowerScan PBT8300 and a generic Bluetooth peripheral. For further information, download "Initial Bluetooth Connection Guide," available on the Datalogic website in the PowerScan BT section.*

Linking to a PC in Serial Port Profile (Slave) Mode

To link a PowerScan BT8300 reader in Serial Port Profile (Slave) Mode to a Bluetooth-enabled host, read the following codes in the given sequence.

1. 

Enter Configuration
2. 

Serial Port Profile (Slave)
3. 

Exit and Save Configuration
4. Use the HOST computer's Bluetooth manager to "Add Bluetooth Device Wizard" and select "PowerScan BT8300." When prompted for a passkey, enter the default of "1234" or whatever you have already assigned to your scanner. A window will notify you of Incoming Port and Outcoming Port when the PowerScan BT8300 is successful added to the PC.
5. Open the Outcoming Port using your application program; for test purposes you can verify the communication using the Hyperterminal tool in Windows.
6. Four ascending beeps will be emitted, signaling that the PowerScan BT8300 has been successfully connected to the Bluetooth-enabled PC.

END of procedure. YOUR READER IS NOW READY TO READ CODES.

Linking to a PC in Serial Port Profile (Master) Mode

To link a PowerScan BT8300 reader in Serial Port Profile (Master) Mode to a Bluetooth-enabled host, follow the instructions below and read the bar codes in the given sequence.

1. Select the "COM Ports" tab on the Window's Bluetooth Manager and add the Incoming Port. You will receive a notification that the Incoming Port is added successfully.
2. Open the Incoming Port using your application program; for test purposes you can verify the communication using the Hyperterminal tool in Windows.

3. Enter Configuration

4. Serial Port Profile (Master)

5. Host Address

6. +
12 digits for the Host Bluetooth adapter



7. Exit and Save Configuration

8. When prompted for a passkey, enter the default of "1234" or whatever you have already assigned to your scanner.
9. Four ascending beeps will be emitted, signaling that the PowerScan BT8300 has been successfully connected to the Bluetooth-enabled PC and the Green LED on the reader will stop blinking.

END of procedure. YOUR READER IS NOW READY TO READ CODES.

Linking to a PC in HID

To link a PowerScan BT8300 reader in HID to a Bluetooth-enabled PC, please read the following bar codes in the given sequence:

1. 
Enter Configuration
2. 
HID Profile
3. 
Exit and Save Configuration
4. Use the host computer's Bluetooth Manager to "Add Bluetooth Device Wizard" and select "PowerScan BT8300." In the next window, enter the PIN code if you are using Security Mode 2 or Security Mode 3, or choose "Don't use passkey" if you set Security Mode 1.



The default Security Mode in HID mode is mode 1 - Authentication and Encryption Disable.

5. Four ascending beeps will be emitted, signaling that the PowerScan BT8300 has been successfully connected to the Bluetooth-enabled PC.

END of procedure. YOUR READER IS NOW READY TO READ CODES.

4.4 Interface Selection

Read the interface selection code for your application.

RS-232

Standard



POS TERMINALS

Nixdorf Mode A



Fujitsu



ICL Mode



For POS terminal default settings refer to par. 5.15.

PEN



WEDGE

IBM AT or PS/2 PCs



IBM XT



PC Notebook



IBM SURE1



IBM Terminal 3153



IBM TERMINALS 31XX, 32XX, 34XX, 37XX:

To select the interface for these IBM Terminals, read the correct KEY TRANSMISSION code. Select the KEYBOARD TYPE if necessary (default = advanced keyboard).

KEY TRANSMISSION MODE

make-only keyboard



make-break keyboard



KEYBOARD TYPE

◆ advanced keyboard



typewriter keyboard



ALT MODE

The ALT-mode selection allows barcodes sent to the PC to be interpreted correctly independently from the Keyboard Nationality used. **You do not need to make a Keyboard Nationality selection.**

(default = Num Lock Unchanged). **Make sure the Num Lock key on your keyboard is ON.**

IBM AT - ALT mode



PC Notebook - ALT mode



WYSE TERMINALS

ANSI Keyboard



PC Keyboard



ASCII Keyboard



VT220 style Keyboard



DIGITAL TERMINALS

VT2xx/VT3xx/VT4xx



4.5 USB Reader Configuration

The USB interface is available for PowerScan™ BC 8030-BT devices and is compatible with the following Operating Systems:

Windows 98 (and later)	IBM POS for Windows
Mac OS 8.0 (and later)	4690 Operating System

USB Start-up

As with all USB devices, upon connection, the Host performs several checks by communicating with the device. During this phase normal operations are suspended. Basic conditions must be met before the device is ready — **the correct USB driver must be loaded.**

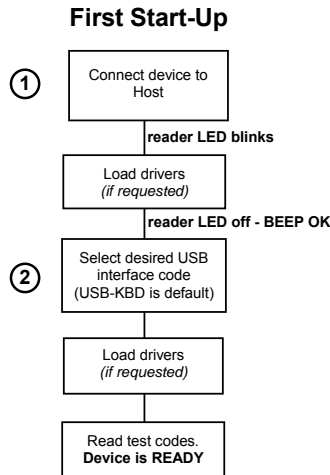

① For all systems, the correct USB driver for the default USB-KBD interface is included in the Host Operating System and will either be loaded automatically or will be suggested by the O.S. and should therefore be selected from the dialog box (the first time only).

Normally the Host supplies sufficient power to the device and the start-up phase ends correctly.

In rare cases, if the Host does not supply sufficient power to the device, a dialog box will appear on the Host and the device will be blocked. In this case, disconnect the USB device cable **at the Host**, and then try a different USB port as indicated by the Operating System message. (The device emits the beep OK signal. You can now read codes).

② At this point you can read the USB interface configuration code according to your application. Load drivers from the O.S. (if requested). When configuring the USB-COM interface, the relevant files and drivers must be installed from the USB Device Installation software, which can be downloaded from the web page <http://www.scanning.datalogic.com>.

The device is ready. Successive start-ups will automatically recognize the previously loaded drivers.

USB

USB-KBD



USB-KBD-ALT-MODE



USB-KBD-APPLE



USB-COM*



USB-IBM-Table Top



USB-IBM-Hand Held



* When configuring USB-COM, the relevant files and drivers must be installed from the USB Device Installation software, which can be downloaded from the web site <http://www.scanning.datalogic.com>.

4.6 Changing Default Settings

Once your reader is set up, you can change the default parameters to meet your application needs. Refer to the preceding paragraphs for initial configuration in order to set the default values and select the interface for your application.

In this manual, the configuration parameters are divided into logical groups making it easy to find the desired function based on its reference group.

The first four groups are for Standard Interface parameter configuration for PowerScan BT8300/BC 8080-BT configurations only:

- **RS-232**
- **USB**
- **WEDGE**
- **PEN EMULATION**

The following parameter groups are common to all interface applications:

DATA FORMAT parameters regard the messages sent to the Host system for all interfaces except Pen Emulation.

POWER SAVE manages overall current consumption in the reading device.

READING PARAMETERS control various operating modes and indicator status functioning.

DECODING PARAMETERS maintain correct barcode decoding in certain special reading conditions.

CODE SELECTION parameters allow configuration of a personalized mix of codes, code families and their options.

ADVANCED FORMATTING PARAMETERS allow code concatenation and advanced formatting of messages towards the Host. It cannot be used with Pen Emulation connections.

RADIO PARAMETERS allow configuration of radio control parameters.

BLUETOOTH PARAMETERS provide options for configuring Bluetooth parameters.

DISPLAY PARAMETERS (some BT8300 series models only) allow configuration of reader display parameters.

RS-232 PARAMETERS

PowerScan™ BT8300/BC 8030-BT configurations only

⊙	BAUD RATE	⊙
⊙	PARITY	⊙
⊙	DATA BITS	⊙
⊙	STOP BITS	⊙
⊙	HANDSHAKING	⊙
⊙	INTER-CHARACTER DELAY	⊙
⊙	SERIAL TRIGGER LOCK	⊙

1. Read the **Enter Configuration** code ONCE, available at the top of each page.

2. Read configuration codes from the desired groups.



= Read the code and follow the procedure given



= Default value

3. Read the **Exit and Save Configuration** code ONCE, available at the top of each page.

Enter Configuration



RS-232

Exit and Save Configuration



BAUD RATE

300 baud



600 baud



1200 baud



2400 baud



4800 baud



◆ 9600 baud



19200 baud



38400 baud



PARITY

◆ none



even parity



odd parity



DATA BITS

7 bits



◆ 8 bits



9 bits



Enter Configuration



RS-232

Exit and Save Configuration



STOP BITS

◆ 1 stop bit



2 stop bits



HANDSHAKING

◆ disable



hardware (RTS/CTS)



software (XON/XOFF)



RTS always ON



See par. 5.1.1 for details.

INTER-CHARACTER DELAY



delay between characters transmitted to Host



Read 2 numbers from the table where:

- 00 = DELAY disabled
- 01-99 = DELAY from 1 to 99 milliseconds

◆ delay disabled

SERIAL TRIGGER LOCK

◆ disabled



enable and select characters



Read 2 characters from the Hex/Numeric table in the range 00-FE where:

- First Character enables device trigger
- Second Character inhibits device trigger until the first character is received again.

USB PARAMETERS

	USB-COM	
⊙	<i>HANDSHAKING</i>	⊙
⊙	<i>INTER-CHARACTER DELAY</i>	⊙
⊙	<i>SERIAL TRIGGER LOCK</i>	⊙
	USB-KBD	
⊙	Keyboard Nationality	⊙
⊙	Inter-character delay	⊙
⊙	Inter-code Delay	⊙
⊙	USB keyboard speed	⊙
	USB-IBM	
⊙	No parameter selection required.	⊙

1. Read the **Enter Configuration** code ONCE, available at the top of each page.

2. Read configuration codes from the desired groups.



= Read the code and follow the procedure given



= Default value

3. Read the **Exit and Save Configuration** code ONCE, available at the top of each page.



HANDSHAKING

◆ disable



hardware (RTS/CTS)



software (XON/XOFF)



RTS always ON



See par. 5.1.1 for details.

INTER-CHARACTER DELAY



delay between characters transmitted to Host

**Read 2 numbers from the table where:**

- 00 = DELAY disabled
- 01-99 = DELAY from 1 to 99 milliseconds

◆ delay disabled

SERIAL TRIGGER LOCK

◆ disabled



enable and select characters

**Read 2 characters from the Hex/Numeric table in the range 00-FE where:**

- First Character enables device trigger
- Second Character inhibits device trigger until the first character is received again.

Enter Configuration



USB-KBD

Exit and Save Configuration



KEYBOARD NATIONALITY

Not Available for USB-KBD-ALT-MODE Interface

This parameter default value is restored through the Interface Selection code and not Restore Default.

Belgian



English (UK)



French



German



Italian



Spanish



Swedish



◆ USA





USB-KBD



The following Japanese and Eastern Block Keyboard Nationality selections are valid only for IBM AT compatible PCs.



INTER-CHARACTER DELAY



delay between characters transmitted to Host



Read 2 numbers from the table where:

00 = DELAY disabled
01-99 = DELAY from 1 to 99 milliseconds

◆ delay disabled

Enter Configuration



USB-KBD

Exit and Save Configuration



INTER-CODE DELAY



delay between codes transmitted to Host



Read 2 numbers from the table where:

- 00 = DELAY disabled
- 01-99 = DELAY from 1 to 99 seconds

◆ delay disabled

USB KEYBOARD SPEED

◆ Normal



Fast



WEDGE PARAMETERS

PowerScan™ BT8300/BC 8030-BT configurations only

⊙	KEYBOARD NATIONALITY	⊙
⊙	CAPS LOCK	⊙
⊙	CAPS LOCK AUTO-RECOGNITION	⊙
⊙	NUM LOCK	⊙
⊙	INTER-CHARACTER DELAY	⊙
⊙	INTER-CODE DELAY	⊙
⊙	KEYBOARD SETTING	⊙
⊙	CONTROL CHARACTER EMULATION	⊙

1. Read the **Enter Configuration** code ONCE, available at the top of each page.

2. Read configuration codes from the desired groups.



= Read the code and follow the procedure given



= Default value

3. Read the **Exit and Save Configuration** code ONCE, available at the top of each page.

Enter Configuration



WEDGE

Exit and Save Configuration



KEYBOARD NATIONALITY

Belgian



English (UK)



French



German



Italian



Spanish



Swedish



◆ USA



The Japanese and Eastern Block Keyboard Nationality selections are valid only for IBM AT compatible PCs.

Japanese



Russian (Latin)



Russian (Cyrillic)



Hungarian



Slovenian, Croatian,
Serbian (Latin)



Romanian



Czech Republic



Enter Configuration



Exit and Save Configuration



WEDGE

CAPS LOCK

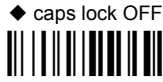

◆ caps lock OFF



caps lock ON

Select the appropriate code to match your keyboard caps lock status.

NOTE: Caps lock manual configuration is ignored when Caps Lock Auto-Recognition is enabled.

For **PC Notebook** interface selections, the caps lock status is automatically recognized; therefore this command is not necessary.

CAPS LOCK AUTO-RECOGNITION (IBM AT COMPATIBLE ONLY)



disable



◆ enable

NUM LOCK

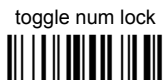

toggle num lock



◆ num lock unchanged

This selection is used together with the Alt Mode interface selection for AT or Notebook PCs.

It changes the way the Alt Mode procedure is executed; therefore it should be set as follows:

- if your keyboard Num Lock is normally on use **num lock unchanged**
- if your keyboard Num Lock is normally off use **toggle num lock**

In this way the device will execute the Alt Mode procedure correctly for your application.

INTER-CHARACTER DELAY



delay between characters transmitted to Host



Read 2 numbers from the table where:

00 = DELAY disabled
01-99 = DELAY from 1 to 99 milliseconds

◆ delay disabled



WEDGE



INTER-CODE DELAY



delay between codes transmitted to Host



Read 2 numbers from the table where:

00 = DELAY disabled
01-99 = DELAY from 1 to 99 seconds

◆ delay disabled

KEYBOARD SETTING

ALPHANUMERIC KEYBOARD SETTING

The device (reader or cradle) can be used with terminals or PCs with various keyboard types and nationalities through a simple keyboard setting procedure.

The type of computer or terminal must be selected before activating the keyboard setting command.

Keyboard setting consists of communicating to the device how to send data corresponding to the keyboard used in the application. The keys must be set in a specific order.

Press and release a key to set it.

Some characters may require more than one key pressed simultaneously during normal use (refer to the manual of your PC or terminal for keyboard use). The exact sequence must be indicated to the reader in this case pressing and releasing the different keys.

Example:

If one has to press the "Shift" and "4" keys simultaneously on the keyboard to transmit the character "\$" to the video, to set the "\$", press and release "Shift" then press and release "4".

Each pressed and released key must generate an acoustic signal on the device; otherwise repress the key. Never press more than one key at the same time, even if this corresponds to the normal use of your keyboard.

Press "Backspace" to correct a wrong key entry. In this case the device emits 2 beeps.

NOTE: "CAPS LOCK" and "NUM LOCK" must be off before starting the keyboard setting procedure. "SHIFT" must be repressed for each character and cannot be substituted by "CAPS LOCK".



setting the alphanumeric keyboard



Read the code above.

Press the keys shown in the following table according to their numerical order.

Some ASCII characters may be missing as this depends on the type of keyboard: these are generally particular characters relative to the various national symbologies. In this case:

- **The first 4 characters (Shift, Alt, Ctrl, and Backspace) can only be substituted with keys not used, or substituted with each other.**
- characters can be substituted with other single symbols (e.g. "SPACE") even if not included in the barcode set used.
- characters can be substituted with others corresponding to your keyboard.

The device signals the end of the procedure with 2 beeps indicating the keys have been registered.



WEDGE



KEYBOARD SETTING (continued)

01 : Shift		
02 : Alt		
03 : Ctrl		
04 : Backspace		
05 : SPACE	28 : 7	51 : N
06 : !	29 : 8	52 : O
07 : "	30 : 9	53 : P
08 : #	31 : :	54 : Q
09 : \$	32 : ;	55 : R
10 : %	33 : <	56 : S
11 : &	34 : =	57 : T
12 : '	35 : >	58 : U
13 : (36 : ?	59 : V
14 :)	37 : @	60 : W
15 : *	38 : A	61 : X
16 : +	39 : B	62 : Y
17 : ,	40 : C	63 : Z
18 : -	41 : D	64 : [
19 : .	42 : E	65 : \
20 : /	43 : F	66 :]
21 : 0	44 : G	67 : ^
22 : 1	45 : H	68 : _ (underscore)
23 : 2	46 : I	69 : `
24 : 3	47 : J	70 : {
25 : 4	48 : K	71 :
26 : 5	49 : L	72 : }
27 : 6	50 : M	73 : ~
		74 : DEL



CAUTION

Do not place the reader onto the BC 8030-BT cradle during this procedure. Otherwise, the battery charging will occur modifying the LEDs functioning.

CONTROL CHARACTER EMULATION

◆ Ctrl + Shift + Key



Ctrl + Key



PEN EMULATION

PowerScan™ BT8300/BC 8030-BT configurations only

⊙	OPERATING MODE	⊙
⊙	MINIMUM OUTPUT PULSE	⊙
⊙	CONVERSION TO CODE 39 AND CODE 128	⊙
⊙	OVERFLOW	⊙
⊙	OUTPUT LEVEL	⊙
⊙	IDLE LEVEL	⊙
⊙	INTER-BLOCK DELAY	⊙

1. Read the **Enter Configuration** code ONCE, available at the top of each page.
2. Read configuration codes from the desired groups.

◆ = Default value
3. Read the **Exit and Save Configuration** code ONCE, available at the top of each page.

Enter Configuration



PEN EMULATION

Exit and Save Configuration



The operating mode parameters are complete commands and do not require reading the Enter and Exit configuration codes.

OPERATING MODE

◆ interpret mode



Interprets commands without sending them to the decoder.

transparent mode



Sends commands to the decoder without interpreting them.

Enter Configuration



PEN EMULATION

Exit and Save Configuration



MINIMUM OUTPUT PULSE

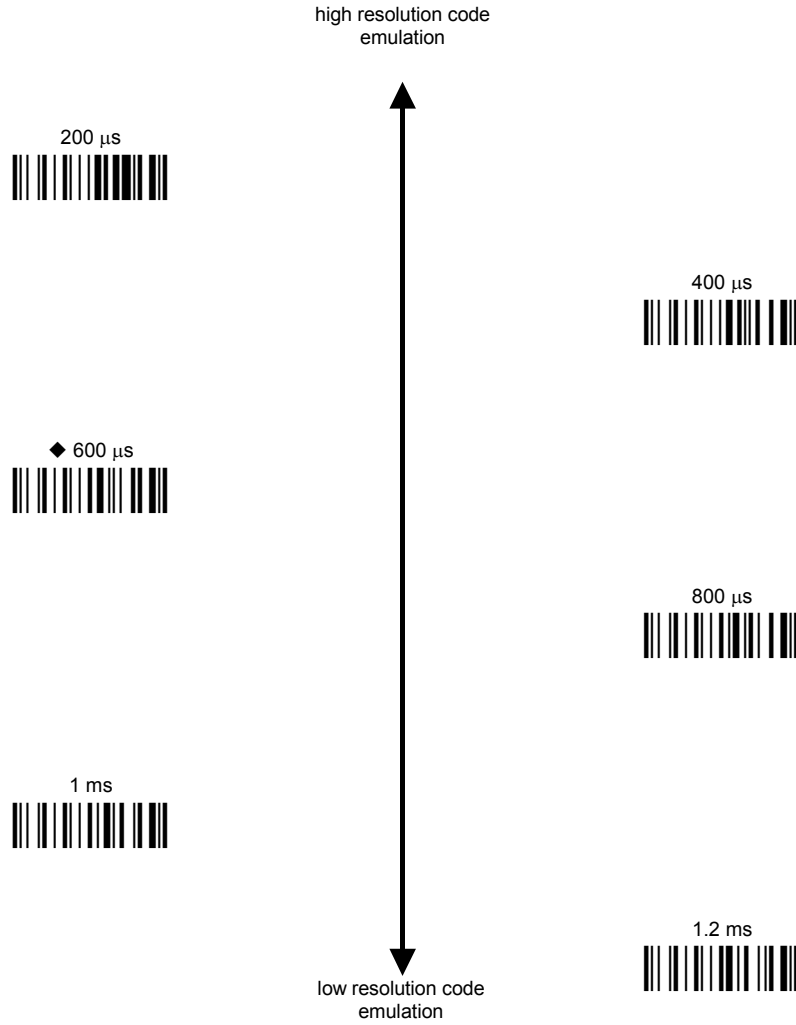

See par. 5.2.1 for details.

Enter Configuration



PEN EMULATION

Exit and Save Configuration



CONVERSION TO CODE 39 AND CODE 128

◆ enable conversion to Code 39



Converts codes read into Code 39 format.

enable conversion to Code 128



Converts codes read into Code 128 format.

See par. 5.2.2 for details.

OVERFLOW

narrow



◆ medium



wide



See par. 5.2.2 for details.

OUTPUT LEVEL

◆ normal



(white = logic level 0)

inverted



(white = logic level 1)

See par. 5.2.4 for details.

Enter Configuration



PEN EMULATION

Exit and Save Configuration



IDLE LEVEL

◆ normal



(black level)

inverted



(white level)

See par. 5.2.4 for details.

INTER-BLOCK DELAY



delay between character blocks transmitted to Host



Read 2 numbers from the table where:

00 = DELAY disabled
01-99 = DELAY from .1 to **9.9** seconds

◆ delay disabled

See par. 5.2.5 for details.

DATA FORMAT

NOT FOR PEN INTERFACES

⊙	CODE IDENTIFIER	⊙
⊙	CRADLE CODE IDENTIFIER	⊙
⊙	READER CODE IDENTIFIER	⊙
⊙	CUSTOM CODE IDENTIFIER	⊙
⊙	CRADLE HEADER	⊙
⊙	READER HEADER	⊙
⊙	CRADLE TERMINATOR	⊙
⊙	READER TERMINATOR	⊙
⊙	SPECIAL KEYS	⊙
⊙	FIELD ADJUSTMENT	⊙
⊙	FIELD ADJ. CHARACTER	⊙
⊙	CRADLE CODE LENGTH	⊙
⊙	READER CODE LENGTH	⊙
⊙	CHARACTER REPLACEMENT	⊙
⊙	ADDRESS STAMPING	⊙
⊙	ADDRESS DELIMITER	⊙
⊙	TIME STAMPING	⊙
⊙	TIME STAMPING DELIMITER	⊙

1. Read the **Enter Configuration** code ONCE, available at the top of each page.

2. Read configuration codes from the desired groups.



= Read the code and follow the procedure given



= Default value

3. Read the **Exit and Save Configuration** code ONCE, available at the top of each page.

DATA FORMAT

CODE IDENTIFIER TABLE			
CODE	AIM STANDARD	DATALOGIC STANDARD	Custom
2/5 interleaved]I y	N	
2/5 industrial]X y	P	
2/5 normal 5 bars]S y	O	
2/5 matrix 3 bars]X y	Q	
EAN 8]E 4	A	
EAN 13]E 0	B	
UPC A]X y	C	
UPC E]X y	D	
EAN 8 with 2 ADD ON]E 5	J	
EAN 8 with 5 ADD ON]E 6	K	
EAN 13 with 2 ADD ON]E 1	L	
EAN 13 with 5 ADD ON]E 2	M	
UPC A with 2 ADD ON]X y	F	
UPC A with 5 ADD ON]X y	G	
UPC E with 2 ADD ON]X y	H	
UPC E with 5 ADD ON]X y	I	
Code 39]A y	V	
Code 39 Full ASCII]A y	W	
CODABAR]F y	R	
ABC CODABAR]X y	S	
Code 128]C y	T	
EAN 128]C y	k	
ISBT 128]C4	f	
Code 93]G y	U	
CIP/39]X y	Y	
CIP/HR]X y	e	
Code 32]X y	X	
MSI]M y	Z	
Code 11]H y	b	
Code 16K]K 0	p	
Code 49]T y	q	
GS1 DataBar™ Expanded Linear and Stacked]e 0	t	
GS1 DataBar Limited]e 0	v	
GS1 DataBar 14 Linear and Stacked]e 0	u	

- AIM standard identifiers are not defined for all codes: the X identifier is assigned to the code for which the standard is not defined. The y value depends on the selected options (check digit tested or not, check digit tx or not, etc.).
- When customizing the Datalogic Standard code identifiers, 1 or 2 identifier characters can be defined for each code type. If only 1 identifier character is required, the second character must be selected as **FF** (disabled).
- The code identifier can be singly disabled for any code by simply selecting **FF** as the first identifier character.
- Write in the Custom character identifiers in the table above for your records.



DATA FORMAT



CRADLE CODE IDENTIFIER

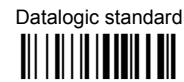

READER CODE IDENTIFIER

This parameter forces the reader to insert a code identifier. This feature acts similarly to the Cradle Code Identifier starting on page 42, but is specific to the DK model.



For more information on this feature see par. 5.17.2. See also “Message Formatting” in par. 6.1 and par. 6.2.

**DATA FORMAT**

CUSTOM CODE IDENTIFIER

define custom code identifier(s)



- ① Read the above code.
(Code Identifiers default to Datalogic standard, see table on previous page).
- ② Select the code type from the code table in Appendix B for the identifier you want to change.
- ③ You can define 1 or 2 identifier characters for each code type. If only 1 identifier character is required, the second character must be selected as **FF** (disabled). Read the hexadecimal value corresponding to the character(s) you want to define as identifiers for the code selected in step ②: valid characters are in the range **00-FD**.

Example: To define Code 39 Code Identifier = @

Read define custom code identifier(s) + Code 39 + 40 + FF







DATA FORMAT



CRADLE HEADER



After selecting **one** of the desired Header codes, read the character(s) from the HEX table. Valid characters are in the range **00-FE**. For Wedge and USB-KBD interfaces, it is also possible to read the **Special Key(s)** on page 49.

Example:

 + 41 + 42 + 43 + 44 = Header **ABCD**

For more details see par. 5.3.1 and par. 5.3.2.

READER HEADER

	◆ no header		
	two character header		 one character header 
	four character header		 three character header 
	six character header		 five character header 
	eight character header		 seven character header 

After selecting **one** of the desired Header codes, read the character(s) from the HEX table. Valid characters are in the range **00-FE**. For Wedge and USB-KBD interfaces, it is also possible to read the **Special Key(s)** on page 49.

Example:

	Four character header		Hex codes		Header
Read		+	41 + 42 + 43 + 44	=	ABCD

For more details see par. 5.3.1 and par. 5.3.2. See also "Message Formatting" in par. 6.1 and 6.2.



DATA FORMAT



CRADLE TERMINATOR



After selecting **one** of the desired Header codes, read the character(s) from the HEX table. Valid characters are in the range **00-FE**. For Wedge and USB-KBD interfaces, it is also possible to read the **Special Key(s)** on page 49.

Example:

 + 0D + 0A = Terminator CR LF

For more details see par. 5.3.1 and par. 5.3.2.

READER TERMINATOR

	◆ no terminator 				
				one character terminator  	
	two character terminator  				
				three character terminator  	
	four character terminator  				
				five character terminator  	
	six character terminator  				
				seven character terminator  	
	eight character terminator  				

After selecting **one** of the desired Header codes, read the character(s) from the HEX table. Valid characters are in the range **00-FE**. For Wedge and USB-KBD interfaces, it is also possible to read the **Special Key(s)** on page 49.

Example:

	Two character terminator		Hex codes		Terminator
Read		+	0D + 0A	=	CR LF

For more details see par. 5.3.1 and par. 5.3.2. See also "Message Formatting" in par. 6.1 and par. 6.2.



DATA FORMAT



SPECIAL KEYS

Available only for Wedge IBM AT-PS/2 and USB-KBD Interfaces



It is necessary to define each Special Key by following the procedure given in par. 5.3.2.

NOTE

Select one or more of the following Special Keys according to your needs.

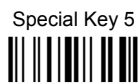
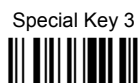
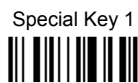



DATA FORMAT

FIELD ADJUSTMENT

◆ disable field adjustment



Field adjustment allows a number of characters n , to be added to or subtracted from the barcode read. The adjustment can be different for each enabled code type. To define the field adjustment:

① Read the enable field adjustment code:

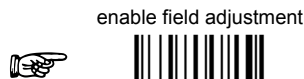

② Select the code type from the Code Identifier Table in Appendix B.

③ Select the type of adjustment to perform:

right addition



right deletion



left addition



left deletion



④ Read a number in the range **01 - 32** from the Hex/Numeric Table to define how many characters to add or delete:

Conditions:

- Adjustment is only performed on the barcode data, the Code Identifier and Code Length Transmission fields are not modified by the field adjustment parameter.
- If the field setting would subtract more characters than exist in the barcode, the subtraction will take place only to code length 0.
- You can set up to a maximum of 10 different field adjustments on the same barcode family or on different barcode families.

Example: To add 4 characters to the right of Standard Code 39 Codes:





DATA FORMAT

FIELD ADJUSTMENT CHARACTER

- ① Read the field adjustment character code:

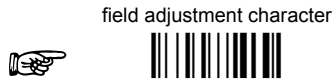

- ② Read the hexadecimal value corresponding to the character you want to use for field adjustment. Valid characters are in the range **00-FE**. For Wedge and USB-KBD interfaces, it is also possible to read the **Special Key(s)** on page 49.

Example:

To define the field adjustment character = **A**:



CRADLE CODE LENGTH



The code length is transmitted in the message after the Headers and Code Identifier characters. The code length is calculated after performing any field adjustment operations.

READER CODE LENGTH



For more information on this feature see par. 5.17.3. See also "Message Formatting" in par. 6.1 and par. 6.2.



DATA FORMAT



CHARACTER REPLACEMENT

- ◆ disable character replacement



This parameter allows up to three characters to be replaced from the barcode read. These substitutions are stored in memory. To define each character replacement:

- ① Read one of the following character replacement codes:



first character replacement



second character replacement



third character replacement



- ② From the Code Identifier Table in Appendix B, read the Code Identifier for the desired code family.
0 = character replacement will be effective for all code families.
- ③ From the Hex/Numeric Table read two characters corresponding to the Hex value (**00-FE**), which identifies the character to be replaced. For Wedge and USB-KBD interfaces, it is also possible to read the **Special Key(s)** on page 49.
- ④ From the Hex/Numeric Table read two characters corresponding to the Hex value (**00-FE**), which identifies the new character to replace. For Wedge and USB-KBD interfaces, it is also possible to read the **Special Key(s)** on page 49.
FF = the character to be replaced will be substituted with no character, that is, it will be removed from the code.

Example:

The following strings define:

1. *First Character Replacement:* substitution in *Code 39 barcodes* of all occurrences of the **0** character with the **1** character.
2. *Second Character Replacement:* substitution in *Code 39 barcodes* of all occurrences of the **A** character with the **B** character.

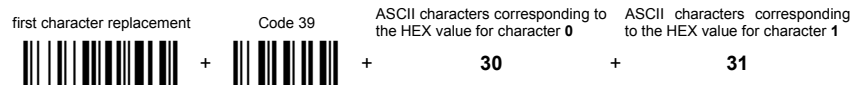

For Code 39 codes containing the string "0123", the contents transmitted will be "1123".

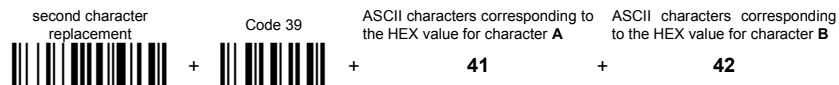

For Code 39 codes containing the string "ABCD", the contents transmitted will be "BBCD".

DATA FORMAT

ADDRESS STAMPING

◆ disable reader address stamping



enable reader address stamping



◆ disable cradle address stamping



enable cradle address stamping



See par. 5.3.3 for details.

ADDRESS DELIMITER

◆ disable reader address delimiter



enable reader address delimiter and
select characters



Read 2 HEX characters in the range **00-FE**.

◆ disable cradle address delimiter



enable cradle address delimiter and
select characters



Read 2 HEX characters in the range **00-FE**.

See par. 5.3.4 for details.



DATA FORMAT



TIME STAMPING

◆ disable



hour/minutes/seconds
month/day/year



hour/minutes/seconds
day/month/year



hour/minutes/seconds



month/day/year



day/month/year



See par. 0 for details.

TIME STAMPING DELIMITER

enable



◆ disable



select delimiter



Read 2 HEX characters in the range **00-FE**.

See par. 5.3.6 for details.

POWER SAVE

⊙	<i>SLEEP STATE</i>	⊙
⊙	<i>ENTER SLEEP TIMEOUT</i>	⊙

1. Read the **Enter Configuration** code ONCE, available at the top of each page.

2. Read configuration codes from the desired groups.



= Read the code and follow the procedure given



= Default value

3. Read the **Exit and Save Configuration** code ONCE, available at the top of each page.



POWER SAVE

SLEEP STATE



See par. 5.4.1 for details.

For BT8300 series readers, sleep state is entered immediately after reading a code and is not configurable.

ENTER SLEEP TIMEOUT

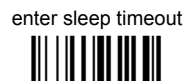

Read 2 numbers in the range 00-99:

00 = Enter Sleep state immediately

01-99 = corresponds to a max. 9.9 sec. delay before entering the Sleep state.

◆ enter sleep timeout = 0.6 sec.

See par. 5.4.2 for details.

READING PARAMETERS

⊙	<i>TRIGGER TYPE</i>	⊙
⊙	<i>TRIGGER SIGNAL</i>	⊙
⊙	<i>TRIGGER CLICK</i>	⊙
⊙	<i>TRIGGER-OFF TIMEOUT</i>	⊙
⊙	<i>FLASH MODE</i>	⊙
⊙	<i>READS PER CYCLE</i>	⊙
⊙	<i>SAFETY TIME</i>	⊙
⊙	<i>BEEPER INTENSITY</i>	⊙
⊙	<i>BEEPER TONE</i>	⊙
⊙	<i>BEEPER TYPE</i>	⊙
⊙	<i>BEEPER LENGTH</i>	⊙
⊙	<i>GOOD READ SPOT DURATION</i>	⊙
⊙	<i>AIMING SYSTEM</i>	⊙
⊙	<i>CRADLE BEEPER INTENSITY</i>	⊙

1. Read the **Enter Configuration** code ONCE, available at the top of each page.

2. Read configuration codes from the desired groups.



= Read the code and follow the procedure given



= Default value

3. Read the **Exit and Save Configuration** code ONCE, available at the top of each page.

**READING PARAMETERS**

TRIGGER TYPE

◆ hardware trigger



Restores TRIGGER MODE

software trigger



Enables FLASH MODE

always on



TRIGGER SIGNAL

◆ trigger active level



trigger active pulse



See par. 5.5.1 for details.

TRIGGER CLICK

◆ disable



enable



See par. 5.5.2 for details.

TRIGGER-OFF TIMEOUT

trigger-off timeout

**Read 2 numbers in the range 00-99:**

00 = disables the trigger-off timeout

01-99 = corresponds to a max. 99-sec. delay after the trigger press to allow the reader to turn off automatically.

◆ trigger-off timeout disabled

See par. 5.5.3 for details.



READING PARAMETERS

FLASH MODE



"FLASH" ON duration



"FLASH" OFF duration



Read 2 numbers in the range 01-99:
01 to 99 = from .1 to 9.9 seconds.

◆ Flash-ON = 1 sec. Flash-OFF = 0.6 sec

READS PER CYCLE

◆ one read per cycle



multiple reads per cycle



See par. 5.5.4 for details.

SAFETY TIME



safety time



Limits same code consecutive reading.

Read 2 numbers in the range 00-99:

00 = no same code consecutive reading until reader is removed (no decoding) for at least 400 ms.
01-99 = timeout from .1 to 9.9 seconds before a consecutive read on same code.

◆ safety time = 0.5 sec

See par. 5.5.5 for details.



READING PARAMETERS



BEEPER INTENSITY

* very low intensity



low intensity



medium intensity



◆ high intensity



* This sets the beeper OFF for data entry, while for all other beeper signals it has the meaning “very low intensity”. The Beeper Intensity parameter is effective for all operating conditions described in par. 7.4.

BEEPER TONE

tone 1



◆ tone 2



tone 3



tone 4



BEEPER TYPE

◆ monotone



bitonal



Enter Configuration



Exit and Save Configuration



READING PARAMETERS

BEEPER LENGTH

long



◆ short



GOOD READ SPOT DURATION

disable



short



◆ medium



long



AIMING SYSTEM

◆ disabled



enabled



CRADLE BEEPER INTENSITY

disable



low intensity



medium intensity



◆ high intensity



DECODING PARAMETERS

⊙	<i>INK SPREAD</i>	⊙
⊙	<i>OVERFLOW CONTROL</i>	⊙
⊙	<i>INTERDIGIT CONTROL</i>	⊙
⊙	<i>DECODING SAFETY</i>	⊙
⊙	<i>PUZZLE SOLVER™</i>	⊙

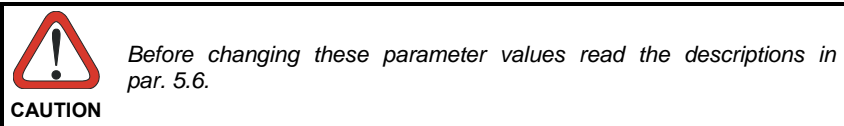

- 1.** Read the **Enter Configuration** code ONCE, available at the top of each page.
- 2.** Read configuration codes from the desired groups.
◆ = Default value
- 3.** Read the **Exit and Save Configuration** code ONCE, available at the top of each page.

Enter Configuration



Exit and Save Configuration



DECODING PARAMETERS

INK SPREAD

disable



◆ enable



See par. 5.6.1 for details.

OVERFLOW CONTROL

disable



◆ enable



See par. 5.6.2 for details.

INTERDIGIT CONTROL

disable



◆ enable



See par. 5.6.3 for details.

DECODING SAFETY

Required number of good reads before accepting code.

◆ one read



(decoding safety disabled)

two reads



three reads



four reads



**DECODING PARAMETERS**

PUZZLE SOLVER™

◆ disable



enable



In the case of damaged or poorly printed codes, this parameter allows reading multiple parts of the single code to reconstruct it.

To read codes using this technology, simply move the illuminated bar over the code so that each line of the code is scanned. During this process a series of brief “ticks” indicates that reading is proceeding correctly.

Conditions:

- This parameter is only valid for the following codes:

EAN 8 without Add-on	EAN 13 without Add-on	UPC A without Add-on
Code 128	Code 39	

- **For Code 39, Check digit control is forced.**
- PuzzleSolver™ is not valid for ISBT 128 code.

CODE SELECTION

⊙	AUTO-CONFIGURATION	⊙
⊙	EAN/UPC FAMILY	⊙
⊙	2/5 FAMILY	⊙
⊙	CODE 39 FAMILY	⊙
⊙	CODE 128 FAMILY	⊙
⊙	CODE 93	⊙
⊙	CODABAR FAMILY	⊙
⊙	MSI	⊙
⊙	CODE 11	⊙
⊙	CODE 16K	⊙
⊙	CODE 49	⊙
⊙	GS1 DATABAR CODES	⊙

1. Read the **Enter Configuration** code ONCE, available at the top of each page.

2. Read configuration codes from the desired groups.



= Read the code and follow the procedure given



= Default value

3. Read the **Exit and Save Configuration** code ONCE, available at the top of each page.



CODE SELECTION



Code selections may be performed according to two different procedures:

- **Auto-configuration**, allowing an automatic recognition and selection of the code families to be read;
- **Manual configuration**, requiring configuration and selection of each code family to be read.

AUTO-CONFIGURATION

The following codes do not require reading the Enter and Exit configuration codes.

In auto-configuration mode the reader enters a particular state, during which it reads, recognizes and saves all information received from the decoding of an existing code (with the exception of MSI, Code 49 and Code 16k code types). In this way, the code families will be automatically configured.

It is possible to configure up to 10 code types, whose length is variable and check digit ignored. If reading different codes belonging to the same family, information about the last code will overwrite the information about the previous one.

Follow the given procedure to auto-configure the desired code families:



CAUTION *If no code is read during the auto-configuration procedure (step ②), the configuration will be empty and therefore the reader will be unable to read codes.*

- ① Read the following code to enter the auto-configuration mode:



auto-configuration



- ② Read an existing code belonging to the code families that you need to configure.
- ③ Read the following code to save the configuration automatically and return to the reader's normal functioning:

save auto-configuration



If you need to change the configuration, repeat the auto-configuration procedure, follow the manual configuration by setting the parameters for each single code family or read the "Restore Default" code on page 146. Be careful that in the latter case all reader parameters will be restored.

DISABLE ALL CODE FAMILIES





NOTE *The reader allows up to 10 code selections. This does not limit the number of CODES enabled to 10, as it depends on the code family.*

Enter Configuration



Exit and Save Configuration



CODE SELECTION

SINGLE SELECTIONS =

- ONE combination code from the EAN family
- ONE code from the 2/5 family

Example

5 code selections:

1. 2/5 Interleaved
2. 2/5 Industrial
3. Code 128 + EAN 128
4. Code 39 Full ASCII + Code 32
5. UPC A/UPC E
6. etc.

In this section all SINGLE code selections are underlined and in bold.

EAN/UPC FAMILY

disable the family



① Read the desired family code

NOTE: Since the EAN/UPC without ADD ON code selection is enabled by default, to correctly enable another selection, first disable the family.

EAN 8/EAN 13/UPC A/UPC E with and without ADD ON



WITHOUT ADD ON

◆ **EAN 8/EAN 13/UPC A/UPC E**



EAN 8/EAN 13



UPC A/UPC E





CODE SELECTION



WITH ADD ON 2 AND 5

EAN 8/EAN 13/UPC A/UPC E



EAN 8/EAN 13



UPC A/UPC E



WITH ADD ON 2 ONLY

EAN 8/EAN 13



UPC A/UPC E



WITH ADD ON 5 ONLY

EAN 8/EAN 13



UPC A/UPC E



WITH AND WITHOUT ADD ON

◆ EAN/UPC with and without ADD ON no
Autodiscrimination



EAN/UPC Autodiscrimination ADD ON by
Prefix



By setting the EAN/UPC Autodiscrimination ADD ON by Prefix, the desired prefixes must be selected by reading the corresponding codes given in the following section, since no prefix is configured by default.

**CODE SELECTION****SELECT EAN/UPC PREFIXES****NOTE**

When scanning the following codes, barcodes starting with the selected prefixes will be read and transmitted only if the ADD ON is present. If no ADD ON is found, the barcode will not be read. Barcodes starting with different characters are read regardless of ADD ON presence and transmitted always without ADD ON.

◆ **Cancel All Selections**

OR

select one or more of the following prefixes:

378/379**434/439****414/419****977****978****979**

The commands above are not mutually exclusive. They can be used to configure more than one set of prefixes simultaneously.

Example:

The following string allows reading and transmitting with ADD ON all EAN/UPC starting with the 434/439, 977 and 978 prefixes:

1. *EAN/UPC Autodiscrimination ADD ON by Prefix.*
2. *434/439: enables reading and transmission with ADD ON of all EAN/UPC barcodes starting with 434/439 prefixes.*
3. *977: enables reading and transmission with ADD ON of all EAN/UPC barcodes starting with 977 prefix.*
4. *978: enables reading and transmission with ADD ON of all EAN/UPC barcodes starting with 978 prefix.*



CODE SELECTION

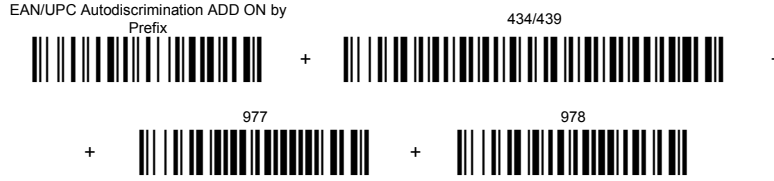

To clear the current prefix selections:

1. *Cancel all Selections*



EAN/UPC CHECK DIGIT TX SELECTIONS

For each code type in this family you can choose to transmit the check digit or not

CHECK DIGIT TRANSMISSION

◆ EAN 8



◆ EAN 13



◆ UPC A



◆ UPC E



NO CHECK DIGIT TRANSMISSION

EAN 8



EAN 13



UPC A



UPC E





CODE SELECTION



CONVERSION OPTIONS

UPC E to UPC A conversion



UPC E to EAN 13 conversion



UPC A to EAN 13 conversion



EAN 8 to EAN 13 conversion



Enable only ISBN conversion



Enable only ISSN conversion



Enable both ISBN and ISSN
conversion



Disable both ISBN and ISSN
conversion





CODE SELECTION

2/5 FAMILY

disable the family



① Read the desired family code



◆ Interleaved 2/5



Normal 2/5 (5 Bars)



Industrial 2/5 (IATA)



Matrix 2/5 (3 Bars)



The pharmaceutical code below is part of the 2/5 family but has no check digit or code length selections.

Code CIP/HR



French pharmaceutical code

② Read a check digit selection

CHECK DIGIT TABLE

no check digit control



◆ check digit control and transmission



check digit control without transmission



③ Read 4 numbers for the code length where:

- **First 2 digits** = minimum code length.
- **Second 2 digits** = maximum code length.

The maximum code length is **99** characters.

The minimum code length must always be less than or equal to the maximum.

Examples:

0199 = variable from 1 to 99 digits in the code.

1010 = 10 digit code length only.



CODE SELECTION

CODE 39 FAMILY

disables the family



① Read the desired family code

② Read a check digit selection

CHECK DIGIT TABLE

◆ Standard Code 39



◆ no check digit control



◆ Full ASCII Code 39



check digit control
and transmission



check digit control
without transmission



The pharmaceutical codes below are part of the Code 39 family but have no check digit selections.

Code CIP39



French pharmaceutical code

Code 32



Italian pharmaceutical code

CODE LENGTH (optional)

The code length selection is valid for the entire Code 39 family

Read the code + 4 numbers for the code length where:

First 2 digits = minimum code length.

Second 2 digits = maximum code length.

The maximum code length is **99** characters.

The minimum code length must always be less than or equal to the maximum.

Examples: **0199** = variable from 1 to 99 digits in the code. **1010** = 10 digit code length only.

set code length





CODE SELECTION

CODE 128 FAMILY

disable the family



① Read the desired family code

◆ **Code 128**



control without transmission of
check digit

ISBT 128



enabling ISBT 128 automatically
disables Puzzle Solver™.

EAN 128



control without transmission of
check digit

Transmit GS Before Code

Code EAN 128 uses the ASCII <GS> character to separate a variable length code field from the next code field. This character can also be transmitted before the code.

◆ disable



enable



If the <GS> character has been modified in the Character Replacement parameter, the new character is affected by this command.

CODE LENGTH (optional)

The code length selection is valid for the entire Code 128 family and is calculated on the output string.

Read the code + 4 numbers for the code length where:

set code length



First 2 digits = minimum code length.

Second 2 digits = maximum code length.

The maximum code length is **99** characters.

The minimum code length must always be less than or equal to the maximum.

Examples: **0199** = variable from 1 to 99 digits in the code. **1010** = 10 digit code length only.

CODE 93

◆ disable the code



Code 93



control without transmission
of check digit



CODE SELECTION

CODABAR FAMILY

◆ disable the family



① Read the desired equality control code

② Read a start/stop transmission selection

Standard Codabar



no start/stop character equality control

START/STOP CHARACTER TRANSMISSION

no transmission



Standard Codabar



start/stop character equality control

transmission



The Codabar ABC code below uses a fixed start/stop character transmission selection.

Codabar ABC



no start/stop character equality control but transmission.

Codabar ABC Forced Concatenation

enable Codabar ABC with forced concatenation



non start/stop character equality control but transmission

CODE LENGTH (optional)

The code length selection is valid for the entire Codabar family

Read the code + 4 numbers for the code length where:

First 2 digits = minimum code length.

Second 2 digits = maximum code length.

The maximum code length is **99** characters.

The minimum code length must always be less than or equal to the maximum.

Examples: **0199** = variable from 1 to 99 digits in the code. **1010** = 10 digit code length only.

set code length





CODE SELECTION

START/STOP CHARACTER CASE IN TRANSMISSION

The start/stop character case selections below are valid for the entire Codabar family:

transmit start/stop characters in lower case



transmit start/stop characters in upper case



MSI

◆ disable the family



Enable the code by selecting one of the check digit selections.

no check digit control



MOD10 check digit control
no check digit transmission



MOD10 check digit control
check digit transmission



MOD11 - MOD10 check digit control
no check digit transmission



MOD11 - MOD10 check digit control
check digit transmission



MOD10 - MOD10 check digit control
no check digit transmission



MOD10 - MOD10 check digit control
check digit transmission



Enter Configuration



Exit and Save Configuration



CODE SELECTION

CODE 11

◆ disable the family



Enable the code by selecting one of the check digit selections.

no check digit control



Type C check digit control
check digit transmitted



Type C check digit control
check digit not transmitted



Type K check digit control
check digit transmitted



Type K check digit control
check digit not transmitted



Type C and Type K
check digit control
check digits transmitted



Type C and Type K
check digit control
check digits not transmitted



CODE 16K

◆ disable the code



Code 16K



To read stacked codes, simply move the reader over the code so that each line of the code is scanned. During this process a series of brief "ticks" indicates that reading is proceeding correctly.



CODE SELECTION



CODE 49

◆ disable the code



Code 49



To read stacked codes, simply move the reader over the code so that each line of the code is scanned. During this process a series of brief “ticks” indicates that reading is proceeding correctly.

GS1 DATABAR™ CODES

◆ disable the family



DISABLE CODE

disable GS1 DataBar Expanded Linear and Stacked



disable GS1 DataBar Limited



disable GS1 DataBar 14 Linear and Stacked



ENABLE CODE

enable GS1 DataBar Expanded Linear and Stacked



enable GS1 DataBar Limited



enable GS1 DataBar 14 Linear and Stacked



To read stacked codes, simply move the reader over the code so that each line of the code is scanned. During this process a series of brief “ticks” indicates that reading is proceeding correctly.

ADVANCED FORMATTING

NOT FOR PEN INTERFACES

<input type="radio"/>	CONCATENATION	<input type="radio"/>
<input type="radio"/>	ADVANCED FORMATTING	<input type="radio"/>



NOTE

Please follow the setup procedure carefully for these parameters.



NOTE

The Advanced Formatting parameters may not be compatible with the IBM USB POS interface selection.

- 1.** Read the **Enter Configuration** code ONCE, available at the top of page.
- 2.** Read configuration codes precisely following the numbered procedure given.
 = Read the code and follow the procedure given
◆ = Default value
- 3.** Read the **Exit and Save Configuration** code ONCE, available at the top of page.



ADVANCED FORMATTING



CONCATENATION

◆ disable



enable



Permits the concatenation of two codes defined by code type and length. It is possible to set a timeout for the second code reading and to define code transmission if the timeout expires.

The order of transmission is **CODE 1-CODE 2**.

Define Concatenation

1

Code 1

code ID



Read the code type from the Code Identifier Table beginning in Appendix B.

code length



Read a number in the range **01-99** from the Hex/Numeric Table.

2

Code 2

code ID



Read the code type from the Code Identifier Table beginning in Appendix B.

code length



Read a number in the range **01-99** from the Hex/Numeric Table.

**ADVANCED FORMATTING****3 Concatenation Result Code ID**

use code 1 ID



use code 2 ID



Since you can concatenate codes from different families, you must select the Code ID character of the resulting code. The Code ID character will be sent in the output message only if it is enabled according to the Code Identifier selection (Datalogic, AIM, or Custom).

4 Concatenation Timeout

timeout

Read two numbers in the range **00 to 99**

00= no timeout

01-99 = timeout from 1 to 99 seconds

Define the timeout, which determines the valid waiting period between the two codes, in order to accept concatenation. If the timeout expires, the resulting action will be based on the following selection. (HHD!!)

5 Transmission after Timeoutno code transmitted
after timeoutonly code 1 transmitted
(if read) after timeoutonly code 2 transmitted
(if read) after timeouteither code 1 or code 2 transmitted
after timeout

ADVANCED FORMATTING

ADVANCED FORMATTING

Advanced formatting has been designed to offer you complete flexibility in changing the format of barcode data **before** transmitting it to the host system. This formatting will be performed when the barcode data meets certain criteria, which you will define in the following procedure.

Up to 4 advanced code management formats can be defined and saved in memory. For each format you must complete the entire configuration procedure:

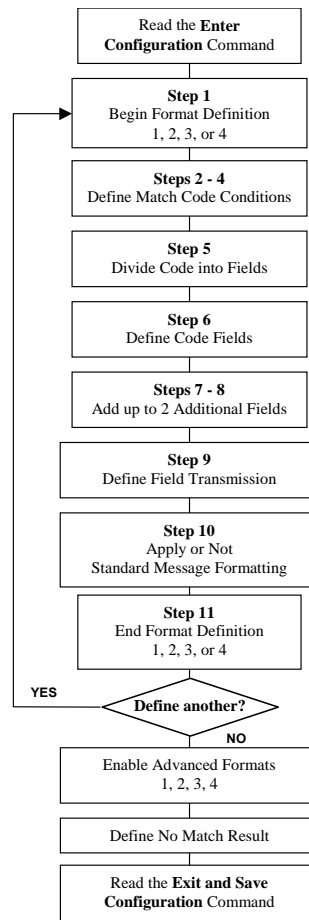



ADVANCED FORMATTING

1 **Begin Format Definition**

begin Format 1 definition



begin Format 2 definition



begin Format 3 definition



begin Format 4 definition



2 **Match Code Type**

match code type



Read the above code + the code type to match from the Code Identifier Table in Appendix B.

OR

any code type



3 **Match Code Length**

match code length



Read the above code + two numbers in the range **01** to **99** for the exact code length.

OR

any code length





ADVANCED FORMATTING

4

Match with Predefined Characters

no match



OR

match with 1 character



match with a 2-character string



match with a 3-character string



match with a 4-character string



After selecting the predefined match code, read the character(s) from the HEX table. Range of characters = **00-FE**.

Example:

Match code with the 2-character predefined string = "@@".

Read  + 40 + 40

AND

position of first character in predefined string



Read the above code + two numbers in the range **01** to **99** representing the character position in the code where the first character of the predefined string must be found.

Read **00** if the match string can be found in any character position.

See par. 5.7.1 for details.

5

Divide Code into Fields

divide code into fields



Read one number in the range **1** to **5** to divide the code into fields.

**ADVANCED FORMATTING****6 Define Code Fields**

define code fields

Each code field length can be set by either:

- a) defining a field separator character to be found in the code itself. In this case you can choose to **discard** the code separator character or **include** it as the last character of the field.

OR BY

- b) defining a match character to be found consecutively repeated in the code itself. In this case the field ends with the first character that does not match.

OR BY





- c) specifying a specific character length up to the maximum of 99 characters.

OR BY



- d) selecting the last field as variable length (if any).

You must define the same number of fields as selected in step 5, including fields that will not be transmitted.



**DEFINE FIELD 1 BY:
EITHER**

a)  field separator

 Read the field separator character from the HEX table. Range of characters = **00-FE**.
 discard separator  include separator 

OR

b)  match character

 Read the match character from the HEX table. Range of characters = **00-FE**.

OR

c)  field length

 Read two numbers in the range **01** to **99** to define the field length.

OR

d)  this is the last field (variable length)

ADVANCED FORMATTING

AND

Field 1 Terminators

no field terminators



1 field terminator







2 field terminators





Read the field terminator character(s) from the HEX table. Valid range of characters for all readers = **00-FE**. For Wedge and USB-KBD interface, it is also possible to read the **Special Key(s)** on page 49.



DEFINE FIELD 2 BY: EITHER

a)  field separator

Read the field separator character from the HEX table. Range of characters = **00-FE**.
discard separator  include separator 



OR

b)  match character

Read the match character from the HEX table. Range of characters = **00-FE**.

OR

c)  field length

Read two numbers in the range **01** to **99** to define the field length.

OR

d)  this is the last field (variable length)

AND

Field 2 Terminators

no field terminators



1 field terminator



2 field terminators





Read the field terminator character(s) from the HEX table. Valid range of characters for all readers = **00-FE**. For Wedge and USB-KBD interface, it is also possible to read the **Special Key(s)** on page 49.





ADVANCED FORMATTING



DEFINE FIELD 3 BY: EITHER

a)   field separator

Read the field separator character from the HEX table. Range of characters = **00-FE**.



 discard separator  include separator

OR

b)   match character

Read the match character from the HEX table. Range of characters = **00-FE**.

OR

c)   field length

Read two numbers in the range **01 to 99** to define the field length.

OR

d)   this is the last field (variable length)

AND

Field 3 Terminators

no field terminators



1 field terminator



2 field terminators







Read the field terminator character(s) from the HEX table. Valid range of characters for all readers = **00-FE**. For Wedge and USB-KBD interface, it is also possible to read the **Special Key(s)** on page 49.





ADVANCED FORMATTING



DEFINE FIELD 4 BY: EITHER

a)  field separator

 Read the field separator character from the HEX table. Range of characters = **00-FE**.
 discard separator  include separator 

OR

b)  match character

 Read the match character from the HEX table. Range of characters = **00-FE**.

OR

c)  field length

 Read two numbers in the range **01** to **99** to define the field length.

OR

d)  this is the last field (variable length)

AND

Field 4 Terminators

no field terminators



1 field terminator



2 field terminators







Read the field terminator character(s) from the HEX table. Valid range of characters for all readers = **00-FE**. For Wedge and USB-KBD interface, it is also possible to read the **Special Key(s)** on page 49.





ADVANCED FORMATTING



DEFINE FIELD 5 BY: EITHER

a)  field separator

 Read the field separator character from the HEX table. Range of characters = **00-FE**.
 discard separator  include separator 

OR

b)  match character

 Read the match character from the HEX table. Range of characters = **00-FE**.

OR

c)  field length

 Read two numbers in the range **01 to 99** to define the field length.

OR

d)  this is the last field (variable length)

AND

Field 5 Terminators

no field terminators



1 field terminator



2 field terminators



Read the field terminator character(s) from the HEX table. Valid range of characters for all readers = **00-FE**. For Wedge and USB-KBD interface, it is also possible to read the **Special Key(s)** on page 49.

ADVANCED FORMATTING

7 First Additional Fixed Field

no fixed field



1 character fixed field



2 character fixed field



3 character fixed field



4 character fixed field



5 character fixed field



6 character fixed field



After selecting **one** of the Additional Fixed Field codes, read the corresponding character(s) from the HEX table. Range of characters = **00-FE**. For Wedge and USB-KBD interface, it is also possible to read the **Special Key(s)** on page 49.

Example:

4 Character Fixed Field
 + 4D + 41 + 49 + 4E = MAIN

**ADVANCED FORMATTING****8****Second Additional Fixed Field**

no fixed field



1 character fixed field



2 character fixed field



3 character fixed field



4 character fixed field



5 character fixed field



6 character fixed field



After selecting **one** of the Additional Fixed Field codes, read the corresponding character(s) from the HEX table. Range of characters = **00-FE**. For Wedge and USB-KBD interface, it is also possible to read the **Special Key(s)** on page 49.

Example:

3 Character Fixed Field



+ 53 + 45 + 54 = SET

9**Field Transmission**

number of fields to transmit



Read one number in the range **1 to 7** for the number of fields to transmit. **Include only fields to be transmitted.**



ADVANCED FORMATTING

Field Order Transmission

Read the codes corresponding to the fields to transmit in the order in which they are to be transmitted. A field can be transmitted more than once. See example.



Example:

The barcode is divided into 3 defined fields plus 1 additional fixed field.
Transmit in the order: Field 2, Additional Field 1, Field 1, Field 2.



10

Standard Formatting

do not apply standard formatting



apply standard formatting



POWERSCAN™ D8330: After performing Advanced Formatting on the barcode read, Standard Formatting (Headers, Code Length, Code ID, Terminators) can be applied to the message to be transmitted.

POWERSCAN™ BT8300: After performing Advanced Formatting on the barcode read, Standard Formatting (Code Length, Code ID) can be applied to the message to be transmitted.



ADVANCED FORMATTING

11

End Format Definition

end Format 1 definition



end Format 2 definition



end Format 3 definition



end Format 4 definition





ADVANCED FORMATTING

Enable Advanced Format

◆ no Advanced Formats enabled



Advanced Format 1

enable



disable



Advanced Format 2

enable



disable



Advanced Format 3

enable



disable



Advanced Format 4

enable



disable



No Match Result

clear data - no transmission



transmit data using standard format



This selection determines the action to be taken when codes read do not conform to the advanced format requisites (no match).

- Codes not matching can be ignored, cleared from memory and not transmitted.
- Codes not matching can be transmitted using the Standard formatting (Headers, Code Length, Code ID, Terminators).

RADIO PARAMETERS

⊙	<i>POWER-OFF TIMEOUT</i>	⊙
⊙	<i>BEEPER CONTROL FOR RADIO RESPONSE</i>	⊙
⊙	<i>BATCH MODE</i>	⊙
⊙	<i>SEE ME</i>	⊙

1. Read the **Enter Configuration** code ONCE, available at the top of each page.
2. Read configuration codes from the desired groups.
 = Read the code and follow the procedure given
3. Read the **Exit and Save Configuration** code ONCE, available at the top of each page.



RADIO PARAMETERS

POWER-OFF TIMEOUT

power-off timeout



Read 2 numbers in the range 00-99:

- 00 = Power-off disabled; reader always ready
- 01-99 = corresponds to a max. 99 hour delay before power-off.
- ◆ power-off after 4 hours.

See par 5.8.1 for details.

BEEPER CONTROL FOR RADIO RESPONSE

◆ normal



only good decode



only good reception



off



See par. 5.8.2 for details.

Enter Configuration



Exit and Save Configuration



RADIO PARAMETERS

BATCH MODE

◆ disable batch



enable normal batch



enable automatic batch



See par. 5.8.3 for details.

The following batch management parameters are complete commands and do not require reading the Enter and Exit configuration codes.

start normal batch transmission



#+BFlush

delete batch data



#+BReset

SEE ME

disable



◆ enable



See par. 5.8.4 for details.

BLUETOOTH PARAMETERS

⊙	COMMUNICATION TYPE	⊙
⊙	BLUETOOTH FRIENDLY NAME	⊙
⊙	LINK BY CONTACT	⊙
⊙	START UP CONNECT	⊙
⊙	AUTO RECONNECT	⊙
⊙	RECONNECT ATTEMPT INTERVAL	⊙
⊙	RECONNECT ATTEMPT MODE	⊙
⊙	POWER CLASS	⊙
⊙	SECURITY MODE	⊙
⊙	PIN LENGTH	⊙
⊙	PIN CODE	⊙
⊙	VARIABLE PIN CODE	⊙
⊙	DISCOVERABLE MODE	⊙
⊙	HID COUNTRY CODE	⊙
⊙	HID CAPS LOCK STATE	⊙
⊙	HID CAPS LOCK AUTO-RECOGNITION (IBM AT COMPATIBLE ONLY)⊙	⊙
⊙	HID ALT MODE	⊙
⊙	HID INTERCHAR DELAY	⊙
⊙	HID SEND UNKNOWN ASCII CHAR	⊙

1. Read the **Enter Configuration** code ONCE, available at the top of each page.
2. Read configuration codes from the desired groups.
 = Read the code and follow the procedure given
3. Read the **Exit and Save Configuration** code ONCE, available at the top of each page.



BLUETOOTH PARAMETERS



COMMUNICATION TYPE

To set up the PowerScan BT8300 to communicate with the BC 8030-BT, or to use standard Bluetooth profiles, scan the Communication Types below:

◆ Handheld - Cradle



Serial Port Profile
(Master)



Serial Port Profile (Slave)



HID Profile



See par. 5.9.1 for more information.

BLUETOOTH FRIENDLY NAME

You can set a meaningful name for PowerScan BT8300 that appears in the application during device discovery. The default name is the scanner name followed by its serial number: **POWERSCAN BT8300 + SERIAL_NUMBER**.

To set a new Bluetooth Friendly Name, scan the barcode below and follow the instructions.



Set Friendly Name



Read 2 numbers in the range 00-26 to define the Length

+

Read HEX characters to define the Bluetooth Friendly Name

Example: To set BT Friendly Name = DATALOGIC

Scan:

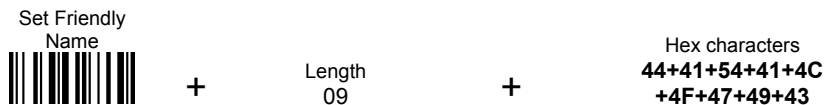



BLUETOOTH PARAMETERS



LINK BY CONTACT



See par. 5.9.2 for more information.

START UP CONNECT



See par. 5.9.4 for more information.

AUTO RECONNECT



See par. 5.9.5 for more information.



BLUETOOTH PARAMETERS

RECONNECT ATTEMPT INTERVAL

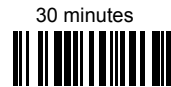

See par. 5.9.6 for more information.

RECONNECT ATTEMPT MODE



See par. 5.9.7 for more information.

POWER CLASS

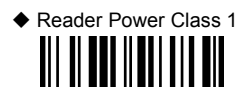

See par. 5.9.8 for more information.

Enter Configuration



Exit and Save Configuration



BLUETOOTH PARAMETERS

SECURITY MODE



Default Reader Security Mode = 1 in Handheld - Cradle and HID Profile; Default Reader Security Mode = 2 in Serial Port Profile (Master) and Serial Port Profile (Slave)

NOTE

◆ Reader Security Mode 1



Reader Security Mode 2



Reader Security Mode 3



◆ Cradle Security Mode 1



Cradle Security Mode 2



Cradle Security Mode 3



See par. 5.9.9 for more information.



BLUETOOTH PARAMETERS

PIN LENGTH

◆ Reader PIN Length = 4



Reader PIN Length= 16



◆ Cradle PIN Length = 4



Cradle PIN Length= 16



See par. 5.9.10 for more information.

PIN CODE

Set Reader PIN Code 4



Set Reader PIN Code 16



Set Cradle PIN Code 4



Set Cradle PIN Code 16



Read HEX numbers to assign a 4 or 16 character PIN Code for the PowerScan BT8300.

Example: If the PIN Length = 4 and want the new PIN Code = 5678, the input HEX numbers will be 35363738



The default PIN code is "1234"

NOTE

See par. 5.9.10 for more information.



BLUETOOTH PARAMETERS



VARIABLE PIN CODE

Some Bluetooth drivers require entering a Variable PIN Code. Scan the barcode below to set the scanner to use a variable pin code.



See par. 5.9.11 for more information.

DISCOVERABLE MODE



HID COUNTRY CODE

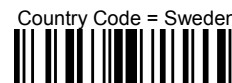
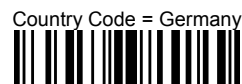
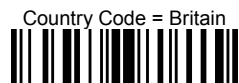
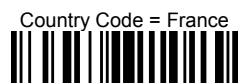

Enter Configuration



Exit and Save Configuration



BLUETOOTH PARAMETERS

HID COUNTRY CODE (continued)

Country Code =
Japanese 106-key



Country Code = Hungary



Country Code =
Romania



Country Code = Slovakia



Country Code = Norway



Country Code =
Switzerland



Country Code = Belgium



Country Code = Poland



Country Code = Croatia



Country Code = Czech
Republic



Country Code =
Denmark



Country Code = Portugal



Enter Configuration



Exit and Save Configuration



BLUETOOTH PARAMETERS

HID CAPS LOCK STATE

◆Caps Lock State =
Caps Lock OFF



Caps Lock State =
Caps Lock ON



HID CAPS LOCK AUTO-RECOGNITION (IBM AT COMPATIBLE ONLY)

◆Enable



Disable



See par 5.9.12 for more information.

HID ALT MODE

Enable



◆Disable



See par. 5.9.13 for more information.

Enter Configuration



Exit and Save Configuration



BLUETOOTH PARAMETERS

HID INTERCHAR DELAY

HID Interchar Delay



+

Read 2 numbers from the table where

00 = DELAY disable

01-99 = DELAY from 1 to 99 milliseconds

◆ Delay disable

See par. 5.9.14 for more information.

HID SEND UNKNOWN ASCII CHAR

◆ Disable



Enable



See par. 5.10 for more information.

DISPLAY and KEYPAD PARAMETERS (3-Key Model)

PowerScan™ BT8300 Series Display and
3-Key readers only

⊙	<i>DATE AND TIME</i>	⊙
⊙	<i>CONTRAST</i>	⊙
⊙	<i>FONT SIZE</i>	⊙
⊙	<i>BACKLIGHT</i>	⊙
⊙	<i>DISPLAY OFF TIMEOUT</i>	⊙
⊙	<i>DISPLAY MODE</i>	⊙
⊙	<i>KEYPAD</i>	⊙

1. Read the **Enter Configuration** code ONCE, available at the top of each page.
2. Read configuration codes from the desired groups.
 = Read the code and follow the procedure given
3. Read the **Exit and Save Configuration** code ONCE, available at the top of each page.

Enter Configuration



Exit and Save Configuration





3-KEY MODEL PARAMETERS

DISPLAY PARAMETERS



DATE AND TIME

set date

Read 6 numbers for DDMMYY

set time

Read 4 numbers for HHMM

CONTRAST



Read the code until the desired contrast is reached.

FONT SIZE



BACKLIGHT



Enter Configuration



3-KEY MODEL PARAMETERS

Exit and Save Configuration



DISPLAY-OFF TIMEOUT

timeout



Read 2 numbers in the range 00-99:

00 = disables display timeout (always on)

01 to 99 = timeout from 1 to 99 seconds.

- ◆ display-off after 8 seconds.
- ◆ delay disabled

DISPLAY MODE

normal



◆ local echo



clear display after decode



See par. 5.10.1 for details.

Enter Configuration



3-KEY MODEL PARAMETERS

Exit and Save Configuration



KEYPAD PARAMETERS

KEYPAD

disable 3-key keypad



◆ enable 3-key keypad and select characters



Read 3 HEX characters in the range **00-FE**, corresponding to the left, center and right keys respectively.

FF = KeyID disabled

- ◆ left = '<'
- center = '='
- right = '>'

See par. 6.3 for details.

DISPLAY and KEYPAD PARAMETERS (16-Key Model)

PowerScan™ BT8300-DK 16-Key readers only

⊙	KEYPAD PARAMETERS	⊙
⊙	DISPLAY PARAMETERS	⊙
⊙	DATA FORMAT	⊙
⊙	OPERATIVE MODE	⊙
⊙	QTY/CODE MODE	⊙

1. Read the **Enter Configuration** code ONCE, available at the top of each page.
2. Read configuration codes from the desired groups.
 = Read the code and follow the procedure given
3. Read the **Exit and Save Configuration** code ONCE, available at the top of each page.



16-KEY DK MODEL PARAMETERS

KEYPAD PARAMETERS

16-KEY KEYPAD ENABLE

The software has the capability to disable or enable the 16-key keyboard.

16-key Keypad Disabled



◆ 16-Key Keypad Enabled



INTERKEY TIMEOUT

The 16-key keypad is organized like a cell phone, with multi-tap access to alpha characters on numeric keys. In alphabetic mode (entered by toggling the Shift key), the keys must be pressed once, twice, or more to obtain the desired letter. See page 153 for more information about the keypad.

This command allows you to specify the time which occurs between a key press, and the confirmation of the letter by the scanner (when in alpha mode). The timeout can be configured in steps of 0,5 second.

0,5 seconds



◆ 1 second



1,5 seconds



2 seconds



KEY PRESS SOUND

Enable/disable the KEY press sound ('click').

Key Press Sound Disabled



◆ Key Press Sound Enabled



**16-KEY DK MODEL PARAMETERS****FUNCTION KEY PROGRAMMING**

There are four function keys, F1, F2, F3, F4, plus the SHIFT key (↑), which can be defined as Function 5. Each of these keys can be programmed to perform a user-assigned function. This is done by associating a function key with an entry in the String Table, which is a database resident on the 16-key PowerScan. You can select either a predefined command or define your own custom string. See the "String Table" command on page 114 to define customized strings for the String Table. See the "Shift Key Programming" command on page 116 to define the SHIFT key as F5.

Each function key has an associated mnemonic label which shows in the display when active. The default labels are shown in the table below. To program the function key labels, see "Function Key Label" command on page 115.

The following table shows the list of commands and available strings.

CMD_ID	Name	Function	Default Label
0	ENTER CMD	(Same as ENTER_KEY)	↵
1	String 1	Associate with String 1 from the String Table	<first 3 char>
2	String 2	Associate with String 2 from the String Table	<first 3 char>
3	String 3	Associate with String 3 from the String Table	<first 3 char>
4	String 4	Associate with String 4 from the String Table	<first 3 char>
5	String 5	Associate with String 5 from the String Table	<first 3 char>
6	Backlight CMD	Toggle the backlight ON/OFF	Lgt
7	Clear CMD	Cancel ALL data entered in the edit field	CLR
8	Backspace CMD	Delete one char per key press from an edit field	←
9	Recall Last CMD	If pressed once it recalls from memory the last code sent out; If pressed twice it will attempt to resend the last sent code	Rec
A	Show Watch	Display the internal time	Tim



define function key



- ① Read the above code to associate a Function Key or the Shift key (if defined as F5) .
- ② Specify which Function Key you want to associate (F1 – F4 or Shift ↑ F5) by scanning a barcode (1-5) from the hex numeric table in the back of this manual.
- ③ Select the label command you want to associate from the table on page 114. Scan a barcode from the hex numeric table corresponding to the command ID (0-A)

Example: To define Function Key 1= Clear command

Read  + Func Key # 1 + CMD ID 7



16-KEY DK MODEL PARAMETERS

STRING TABLE

The Powerscan 16-key model allows you to define a String Table, a database with room for five entries, from String1 to String5, which can be recalled using a Function Key. This is done with Function Key Programming, described on page 114.

The string can be a single 'char'. Default = empty strings.



define string



- ① Read the above code.
- ② Select the string number you want to add by scanning a barcode (1 – 5) from the hex numeric table in the back of this manual.
- ③ Select the desired string length by scanning a barcode (0 – A) from the hex numeric table.
- ④ Define the label string by scanning characters or numerals from the hex numeric table.

Example: To define String 1 = DATALOGIC

	Define string	String #	Length	Hex codes	String text
Read		+ 2	+ 9	+ 44+41+54+41+4C +4F+47+49+43	= DATALOGIC

FUNCTION KEY LABEL

This item allows the user to change the default mnemonic label associated to each individual function key (F1 – F4). This is done by programming a short acronym string or symbol to be shown in the bottom of the display. The purpose of the label is to serve as an indication of the programmed function of the Function Key below it. To program the Function Keys themselves, see the "Function Key Programming" command on page 114.

NOTE: Function key label length is fixed at 4 characters and is not programmable.



define function key label



- ① Read the above code.
- ② Specify which Function Key Label you want to change by scanning a barcode (1-4) from the hex numeric table in the back of this manual.
- ③ Define the label string by scanning 4 characters from the Hex numeric table.

Example: To define Function Key 2 label = D

	Define function key label	Function key #	Hex codes	Text string
Read		+ 2	+ 20 + 20 + 44 + 20	= space space D space

Enter Configuration



Exit and Save Configuration



16-KEY DK MODEL PARAMETERS

LOWER CASE

This function enables/disables the capability to use the SHIFT key to switch to Lower Case (alphanumeric) mode. When enabled, the indication in the upper right corner of display is 'ab'.

◆ Disable Lower Case



Enable Lower Case



SHIFT KEY PROGRAMMING

The SHIFT key (↑) can be programmed to perform a function different than its standard (which is to toggle from numeric to alpha mode). After the Shift Key has been defined as Function 5, refer to the "Function Key Programming" command on page 114 for options.

◆ SHIFT KEY Normal mode



SHIFT KEY Function 5



ECHO

This function enables/disables the keypad echo. It works only when the scanner is in simple data input mode (no QTY/CODE).

◆ Full keypad echo



No echo on Function Key



No echo on any key



Enter Configuration



16-KEY DK MODEL PARAMETERS

Exit and Save Configuration



DISPLAY PARAMETERS

DATE AND TIME

set date



Read 6 numbers for DDMMYY

set time



Read 4 numbers for HHMM

CONTRAST

lighter



darker



Read the code until the desired contrast is reached.

DISPLAY-OFF TIMEOUT



timeout



Read 2 numbers in the range 00-99:

00 = disables display timeout (always on)

01 to 99 = timeout from 1 to 99 seconds.

- ◆ display-off after 8 seconds.
- ◆ delay disabled



16-KEY DK MODEL PARAMETERS

LAST CODE SHOWN TIMEOUT

After the CODE transmission, the last code read will be shown on the display for a configurable timeout (LAST CODE SHOWN TOUT).

NOTE: Just as in the settings for the standard Powerscan, the display has an active timeout before going in OFF state. This timeout has a higher priority than the LAST CODE SHOWN TOUT, so the two parameters should be combined to get the desired result.

Disabled



1 second



◆ 2 seconds



5 seconds



10 seconds



25 seconds



40 seconds



60 seconds



80 seconds



99 seconds



Enter Configuration



Exit and Save Configuration



16-KEY DK MODEL PARAMETERS

BACKLIGHT

This feature defines the behavior of the 16-key scanner Backlight (both for display and keyboard).

◆ All backlighting disabled



Display disabled,
keyboard enabled
(rarely used)



Display enabled,
keyboard disabled



Display enabled,
keyboard enabled



SCREEN REFRESH

Disable screen refresh at the end of keyboard data input. This feature works only in Simple Data Input Mode (no QTY/CODE).

NOTE: When using two-way communication in which the scanner displays data received from the host, the refresh screen should normally be disabled to avoid overwriting messages coming from the host.

◆ Enable



Disable



**16-KEY DK MODEL PARAMETERS****DATA FORMAT**
Keypad Specific Formatting

KEYBOARD DATA FORMAT ENABLE/DISABLE

This feature allows you to enable/disable specific formatting for data entered by keyboard and barcode labels read by the scan engine.

Use this command only if you require differentiation in formatting between scanned barcodes and data that is input from the keyboard. Refer to the standard Data Format section for other formatting options.

NOTE: if you enable different formatting you must define the desired format, otherwise the default data format will be used.

See par. 5.17.1 in the References section for a more detailed description of this feature.

◆ Disabled
(Same as Code)



Enabled
(Different format allowed)



TIME STAMPING MODE

Time Stamping Mode can be applied when entering data from either a barcode, from the keyboard, or both.

NOTE: The standard Time Stamp enable/disable and setup are also applicable. Refer to the “Time Stamping” command on page 54 for more information on this feature.

◆ Data from both
barcode and keyboard



Data only from barcode



Data only from keyboard





16-KEY DK MODEL PARAMETERS

KEYPAD DATA HEADER/TERMINATOR

Keypad Data Header/Terminator creates an optional Header and Terminator data format added to data typed on the keypad.

NOTE: Keyboard data format enable/disable must be used to enable the Header and Terminator setup, so the two parameters should be combined to get the desired result.

HEADER



After selecting **one** of the desired Header codes, read the character(s) from the HEX table. Valid characters are in the range **00-FE**. For Wedge and USB-KBD interfaces, it is also possible to read the **Special Key(s)** on page 49.

Example:

Read Four character header + Hex codes = Header

 + 41 + 42 + 43 + 44 = ABCD

For more details see par. 5.3.1 and par. 5.3.2. See also "Message Formatting" in par. 6.1 and par. 6.2.



16-KEY DK MODEL PARAMETERS

**TERMINATOR**

◆ no terminator



two character terminator



four character terminator



six character terminator



eight character terminator



one character terminator



three character terminator



five character terminator



seven character terminator



After selecting **one** of the desired Header codes, read the character(s) from the HEX table. Valid characters are in the range **00-FE**. For Wedge and USB-KBD interfaces, it is also possible to read the **Special Key(s)** on page 49.

Example:

	Two character terminator		Hex codes		Terminator
Read		+	0D + 0A	=	CR LF

For more details see par. 5.3.1 and par. 5.3.2. See also "Message Formatting" in par. 6.1 and par. 6.2.

Enter Configuration



Exit and Save Configuration



16-KEY DK MODEL PARAMETERS

OPERATIVE MODE

MODE SELECTION

This feature allows the PowerScan PBT8300-DK to operate in one of two basic operative modes:

- SDIM (Simple Data Input Mode) — data entered, either on the keypad or read via barcode, is transmitted the host once the enter key is pressed, following the formatting rules described in the previous paragraph.
- QTY/CODE (Quantity/Code Mode) — Refer to the next section, QTY/CODE MODE PARAMETERS.

◆ Simple Data Input
Mode



Quantity/Code Mode



ENTER KEY CONFIGURATION

This command is active only when the scanner is in Simple Data Input Mode. It defines the behavior of the enter key when no data has been previously entered. By default an error sound is generated; it can also be configured to transmit a "null" character.

◆ Generate error sound



send null char





16-KEY DK MODEL PARAMETERS

QTY/CODE MODE

When the scanner is in Quantity-Code Mode, the operator is prompted with two data fields named QTY= and CODE= . The normal position of the cursor is in the QTY field; the operator is required to type the quantity on the keypad, then press the "enter key" to move the cursor to the CODE field. Data in the CODE field can either be entered manually from the keypad or read through the scanner.

The pair quantity and code are then transmitted to the host in a single string with configurable header, terminators and separator. Use the commands in the following sections to define the configuration parameters.

QTY FIELD

This feature defines the behavior of the scanner if no data is entered in the QTY field so it is left empty. Options are:

- code is transmitted with default QTY ('1')
- code is transmitted alone (without any quantity information)
- code is discarded and an error beep is generated

◆ Transmit code with default QTY (1)



◆ Discard barcode, generate error beep



◆ Transmit code alone (without any quantity information)



QTY/CODE SEND MODE

This feature defines the rules that will be used to send a QTY/CODE pair:

0. code is transmitted with QTY field (and its predefined format) preceding CODE field (and its predefined format)
1. code is transmitted with CODE field (and its predefined format) preceding QTY field (and its predefined format)
2. code in CODE field is sent out for the number of times defined in the QTY field (when using this option the maximum number of times is '9999');

NOTE: Use "Repeat Timeout" on the next page for to set the timeout for this feature.

◆ QTY precedes CODE



◆ CODE sent out = QTY times



◆ CODE precedes QTY



**16-KEY DK MODEL PARAMETERS****REPEAT TIMEOUT**

Repeat Timeout allows the user to program an optional intercode delay (in msec.) between two codes in a set of codes to be transmitted from scanner to host via Radio interface, when the scanner is in quantity mode.

NOTE: Qty/Code Send Mode must be set to option 2 (code in CODE field is sent out for a QTY number of times). See Qty/Code Send Mode on the previous page).

The number of codes depends on the unit inserted via keypad by the user, to cope with different use cases. A minimum delay of 100 ms will be always present, the delay can be adjusted in 10ms increments.

Disable



set Repeat Timeout



- ① Read the above code.
- ② Select the length of the delay you want to set by scanning two barcodes (01 – 99) from the Hex Numeric table in the back of this manual.

Example: To program Repeat Timeout = 60ms

Read		+	Value 06	=	Time (ms) 60ms
------	---	---	--------------------	---	--------------------------



16-KEY DK MODEL PARAMETERS

QTY/CODE SEPARATOR

This feature allows the insertion of a separator between QTY/CODE pairs.

◆ Disable – no separator



define QTY/CODE separator



- ① Read the above code.
- ② Select the length of the separator you want to insert by scanning a barcode (1 – 8) from the Hex Numeric table in the back of this manual.
- ③ Define the separator string using a sequence of four hex ascii codes from the table at the back of this manual.

Example: To define QTY/CODE separator = : (colon)

	Define QTY/CODE separator	length	Hex codes	Text string
Read		1	20 + 20 + 3A + 20	space space : space

For more information on this feature see “Message Formatting” starting in par. 6.1 and 6.2.

APPEND CODE

This function defines how a scanned barcode interacts with a pre-edited CODE field, or with a string entered by a pre-programmed FUNC KEY.

Options are:

0. Barcode data overwrites what is written in the CODE field by keyboard and the code is transmitted;
1. Barcode data is appended to any text in the CODE field and the code is transmitted;
2. Barcode data is appended to any text in the CODE field but the code IS NOT transmitted. Data is transmitted when the enter key is pressed.

NOTE: Option 2 allows the addition of a footer to the scanned barcode ('just in time formatting').

◆ Overwrite CODE and transmit



Append to CODE, don't transmit



Append to CODE and transmit



5 REFERENCES

5.1 RS-232 Parameters

5.1.1 Handshaking

Hardware handshaking: (RTS/CTS)

The RTS line is activated by the decoder before transmitting a character. Transmission is possible only if the CTS line (controlled by the Host) is active.

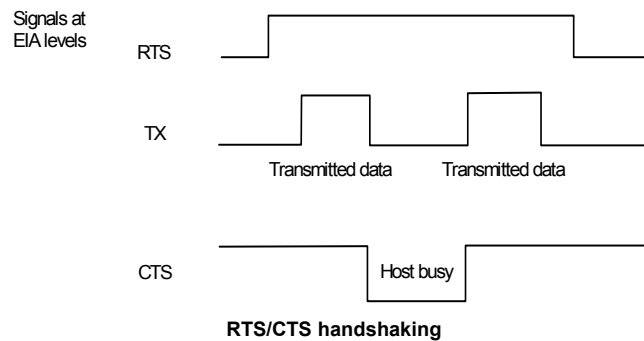

Software handshaking: (XON/XOFF)

During transmission, if the Host sends the XOFF character (13 Hex), the decoder interrupts the transmission with a maximum delay of one character and only resumes when the XON character (11 Hex) is received.

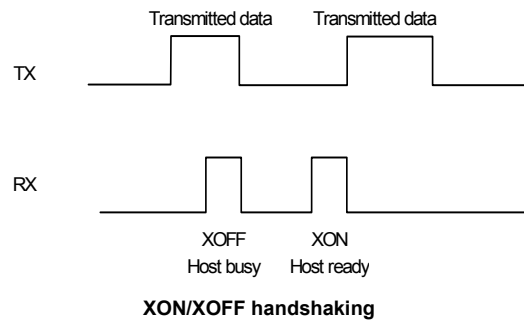

5.2 Pen Parameters

5.2.1 Minimum Output Pulse

This parameter sets the duration of the output pulse corresponding to the narrowest element in the barcode. In this way the code resolution is controlled by the signal sent to the decoder, independently of the physical resolution of the code read.

The shortest pulse (200 μ s) corresponds to a high-resolution code emulation and therefore a shorter transfer speed to the decoder (for decoders able to work on high resolution codes). Likewise, longer pulses correspond to low-resolution code emulation and therefore a longer transfer time to the decoder.

5.2.2 Conversion to Code 39 and Code 128

PowerScan™ BT8300 Series Readers

When using these readers it is possible to choose between converting the decoded codes into either Code 39 format or Code 128 format. It is not possible to disable conversion.

5.2.3 Overflow

This parameter generates a white space before the first bar and after the last bar of the code. The selections are as follows:

- narrow = space 10 times the minimum output pulse.
- medium = space 20 times the minimum output pulse.
- wide = space 30 times the minimum output pulse.

5.2.4 Output and Idle Levels

The following state diagrams describe the different output and idle level combinations for Pen emulation:

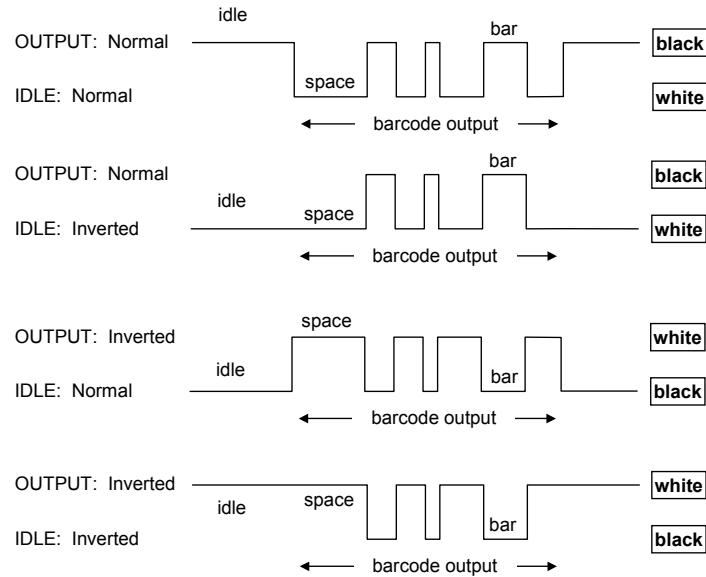

Output and Idle Levels

5.2.5 Inter-Block Delay

For the PEN Emulation interface, data are sent to the Host in fixed size blocks of 20 characters each. The inter-block delay parameter allows setting a delay between each block sent to the Host.

When the PowerScan BT8300 connects with a Bluetooth-Enabled PC, the header and terminator default values will be:

- SPP Profile: no header, terminator CR-LF
- HID Profile: no header, terminator ENTER

5.3 Data Format

For an overview of Message Formatting see Chapter 6.

5.3.1 Header/Terminator Selection

The header/terminator selection is not effected by the reading of the restore default code. In fact, when the PowerScan BT8300 connects with the BC 8030-BT, cradle header and terminator default values depend on the interface selection:

- RS-232: no header, terminator CR-LF
- WEDGE: no header, terminator ENTER

When the PowerScan BT8300 connects with a Bluetooth-Enabled PC, the reader header and terminator default values will be:

- SPP Profile: no header, terminator CR-LF
- HID Profile: no header, terminator ENTER

When the PowerScan BT8300 connects with the BC 8030-BT the default values are usually restored through the reading of RS-232 or WEDGE interface selection code. However, if the PowerScan BT8300 is connected with a Bluetooth-Enabled PC it will NOT reset to default value when switched between Communication Types. In other words, the PowerScan BT8300 can remember the setting of TERMINATOR. See chapter 2.

For the WEDGE interface, the following extended keyboard values can also be configured:

EXTENDED KEYBOARD TO HEX CONVERSION TABLE				
	IBM AT IBM 3153 APPLE ADB	IBM XT	IBM 31xx, 32xx, 34xx, 37xx	Wyse Digital
HEX	KEY	KEY	KEY	KEY
83	ENTER	ENTER	FIELD EXIT	RETURN
84	TAB	TAB	TAB	TAB
85	F1	F1	F1	F1
86	F2	F2	F2	F2
87	F3	F3	F3	F3
88	F4	F4	F4	F4
89	F5	F5	F5	F5
8A	F6	F6	F6	F6
8B	F7	F7	F7	F7
8C	F8	F8	F8	F8
8D	F9	F9	F9	F9
8E	F10	F10	F10	F10
8F	F11	ESC	F11	F11
90	F12	BACKSPACE	F12	F12
91	HOME	HOME	ENTER	F13
92	END	END	RESET	F14
93	PG UP	PG UP	INSERT	F15
94	PG DOWN	PG DOWN	DELETE	F16
95	↑	↑	FIELD -	UP
96	↓	↓	FIELD +	DOWN
97	←	←	ENTER (Paddle)	LEFT
98	→	→	PRINT	RIGHT
99	ESC	ESC		ESC
9A	CTRL (Right)	CTRL (Right)		CTRL (Right)
9B	Euro	Space	Space	Space

For all devices using IBM AT (compatible) Wedge or USB-KBD interfaces, all values from 9C to FE send the relative simulated keypress when available or else the relative ALT-Mode sequence. See the Hex to Character Conversion Table in Appendix C.

For all devices using other Wedge interfaces, all values from 9C to FE send the Space character.

Enter Configuration



5.3.2 Define Special Key Sequence

The Special Key(s) for **Wedge IBM AT-PS/2 and USB-KBD interface users** can be associated with a sequence of keyboard keys that otherwise could not be selected, i.e. ALT + F6, SHIFT + F1. These Special Keys can be used for:

- Headers/Terminators
- Character Replacement
- Field Adjustment
- Custom Code ID
- Advanced Formatting – Define Field
- Advanced Formatting – Additional Fixed Field

Follow the procedure to define the desired Special Key sequence:

1. Read the Enter Configuration code above and select the Special Key to define (one at a time):

Define Special Key 1



Define Special Key 2



Define Special Key 3



Define Special Key 4



Define Special Key 5



2. Read only one code to be associated with the special key sequence:

SHIFT



OR

CTRL



OR

ALT



OR

CTRL + SHIFT



OR

ALT + SHIFT



OR

CTRL + ALT



3. Select the character to be associated with the Special Key sequence by reading the codes corresponding to the 3 character values from Appendix C. Then, read the Exit and Save Configuration code above to complete the Special Key sequence.

The character values having the ^S and ^A symbols **require** SHIFT or ALT keys or key combinations in **step 2**, in particular:

^S = the character is obtained in combination with SHIFT

^A = the character is obtained in combination with ALT

The following character values change according to the keyboard nationality.

KEYB CHAR	ITA	USA	FR	BE	DE	UK	ES	SW	JP
!	016 ^S	016 ^S	04A	03E	016 ^S	016 ^S	016 ^S	016 ^S	016 ^S
"	01E ^S	052 ^S	026	026	01E ^S	01E ^S	01E ^S	01E ^S	01E ^S
#	052 ^A	026 ^S	026 ^A	026 ^A	05D	05D	026 ^A	026 ^S	026 ^S
\$	025 ^S	025 ^S	05B	05B	025 ^S	025 ^S	025 ^S	025 ^A	025 ^S
%	02E ^S	02E ^S	052 ^S	052 ^S	02E ^S	02E ^S	02E ^S	02E ^S	02E ^S
&	036 ^S	03D ^S	016	016	036 ^S	03D ^S	036 ^S	036 ^S	036 ^S
'	04E	052	025	025	05D ^S	052	04E	05D	03D ^S
(03E ^S	046 ^S	02E	02E	03E ^S	046 ^S	03E ^S	03E ^S	03E ^S
)	046 ^S	045 ^S	04E	04E	046 ^S	045 ^S	046 ^S	046 ^S	046 ^S
*	05B ^S	03E ^S	05D	05B ^S	05B	03E ^S	05B ^S	05D ^S	052 ^S
+	05B	055 ^S	055 ^S	04A ^S	05B	055 ^S	05B	04E	04C ^S
,	041	041	03A	03A	041	041	041	041	041
-	04A	04E	036	055	04A	04E	04A	04A	04E
.	049	049	041 ^S	041 ^S	049	049	049	049	049
/	03D ^S	04A	049 ^S	049 ^S	03D ^S	04A	03D ^S	03D ^S	04A
0	045	045	045 ^S	045 ^S	045	045	045	045	045
1	016	016	016 ^S	016 ^S	016	016	016	016	016
2	01E	01E	01E ^S	01E ^S	01E	01E	01E	01E	01E
3	026	026	026 ^S	026 ^S	026	026	026	026	026
4	025	025	025 ^S	025 ^S	025	025	025	025	025
5	02E	02E	02E ^S	02E ^S	02E	02E	02E	02E	02E
6	036	036	036 ^S	036 ^S	036	036	036	036	036
7	03D	03D	03D ^S	03D ^S	03D	03D	03D	03D	03D
8	03E	03E	03E ^S	03E ^S	03E	03E	03E	03E	03E
9	046	046	046 ^S	046 ^S	046	046	046	046	046
:	049 ^S	04C ^S	049	049	049 ^S	04C ^S	049 ^S	049 ^S	052
;	041 ^S	04C	041	041	041 ^S	04C	041 ^S	041 ^S	04C
<	061	041 ^S	061	061	061	041 ^S	061	061	041 ^S
=	045 ^S	055	055	04A	045 ^S	055	045 ^S	045 ^S	04E ^S
>	061 ^S	049 ^S	061 ^S	061 ^S	061 ^S	049 ^S	061 ^S	061 ^S	049 ^S
?	04E	04A ^S	03A ^S	03A ^S	04E ^S	04A ^S	04E ^S	04E ^S	04A ^S
@	04C ^A	01E ^S	045 ^A	01E ^A	015 ^A	052 ^S	01E ^A	01E ^A	054
[054 ^A	054	02E ^A	054 ^A	052 ^S	054	054 ^A	03E ^A	05B
\	00E	05D	03E ^A	061 ^A	04C ^S	061	00E ^A	04E ^A	051
]	05B ^A	05B	04E ^A	05B ^A	054 ^S	05B	05B ^A	046 ^A	05D
^	055 ^S	036 ^S	046 ^A	054	00E	036 ^S	054 ^S	05B ^S	055
_	04A ^S	04E ^S	03E	055	04A ^S	04E ^S	04A ^S	04A ^S	051 ^S
' (accent)	-	00E	03D ^A	05D ^A	055 ^S	00E	054	055 ^S	054 ^S
a	01C	01C	015	015	01C	01C	01C	01C	01C
b	032	032	032	032	032	032	032	032	032
c	021	021	021	021	021	021	021	021	021
d	023	023	023	023	023	023	023	023	023
e	024	024	024	024	024	024	024	024	024
f	02B	02B	02B	02B	02B	02B	02B	02B	02B
g	034	034	034	034	034	034	034	034	034
h	033	033	033	033	033	033	033	033	033

KEYB CHAR	ITA	USA	FR	BE	DE	UK	ES	SW	JP
i	043	043	043	043	043	043	043	043	043
j	03B	03B	03B	03B	03B	03B	03B	03B	03B
k	042	042	042	042	042	042	042	042	042
l	04B	04B	04B	04B	04B	04B	04B	04B	04B
m	03A	03A	04C	04C	03A	03A	03A	03A	03A
n	031	031	031	031	031	031	031	031	031
o	044	044	044	044	044	044	044	044	044
p	04D	04D	04D	04D	04D	04D	04D	04D	04D
q	015	015	01C	01C	015	015	015	015	015
r	02D	02D	02D	02D	02D	02D	02D	02D	02D
s	01B	01B	01B	01B	01B	01B	01B	01B	01B
t	02C	02C	02C	02C	02C	02C	02C	02C	02C
u	03C	03C	03C	03C	03C	03C	03C	03C	03C
v	02A	02A	02A	02A	02A	02A	02A	02A	02A
w	01D	01D	01A	01A	01D	01D	01D	01D	01D
x	022	022	022	022	022	022	022	022	022
y	035	035	035	035	01A	035	035	035	035
z	01A	01A	01D	01D	035	01A	01A	01A	01A
{	-	054 ^S	025 ^A	046 ^A	052	054 ^S	052 ^A	03D ^A	05B ^S
	00E ^S	05D ^S	036 ^A	016 ^A	04C	061 ^S	016 ^A	061 ^A	06A ^S
}	-	05B ^S	055 ^A	045 ^A	054	05B ^S	05D ^A	045 ^A	05D ^S
~	-	00E ^S	01E ^A	04A ^A	04E	05D ^S	-	05B ^A	055 ^S



To use upper case letters, it is necessary to read one of the *SHIFT* commands from step 2 before the value corresponding to the lower case letters.

NOTE

The following key values are common to all the keyboard nationalities.

KEYB KEY	ITA	USA	FR	BE	DE	UK	ES	SW	JP
ENTER	05A	05A	05A	05A	05A	05A	05A	05A	05A
TAB	00D	00D	00D	00D	00D	00D	00D	00D	00D
F1	005	005	005	005	005	005	005	005	005
F2	006	006	006	006	006	006	006	006	006
F3	004	004	004	004	004	004	004	004	004
F4	00C	00C	00C	00C	00C	00C	00C	00C	00C
F5	003	003	003	003	003	003	003	003	003
F6	00B	00B	00B	00B	00B	00B	00B	00B	00B
F7	083	083	083	083	083	083	083	083	083
F8	00A	00A	00A	00A	00A	00A	00A	00A	00A
F9	001	001	001	001	001	001	001	001	001
F10	009	009	009	009	009	009	009	009	009
F11	078	078	078	078	078	078	078	078	078
F12	007	007	007	007	007	007	007	007	007
Home	26C	26C	26C	26C	26C	26C	26C	26C	26C
End	269	269	269	269	269	269	269	269	269
PG UP	27D	27D	27D	27D	27D	27D	27D	27D	27D
PG down	27A	27A	27A	27A	27A	27A	27A	27A	27A
Up arrow	275	275	275	275	275	275	275	275	275
Down arrow	272	272	272	272	272	272	272	272	272
Left arrow	26B	26B	26B	26B	26B	26B	26B	26B	26B
Right arrow	274	274	274	274	274	274	274	274	274
Esc	076	076	076	076	076	076	076	076	076
Ctrl right	214	214	214	214	214	214	214	214	214
€	02E ^A	02E ^A	024 ^A	024 ^A	024 ^A	025 ^A	02E ^A	02E ^A	-
SPACE	029	029	029	029			029		029



If Caps Lock Auto-Recognition is disabled, it is necessary to verify that the keyboard caps lock status matches that on the reader.

NOTE

EXAMPLES

- Defining Special Key Sequences -

1. The following example allows defining Special Key 1 as SHIFT + F5:

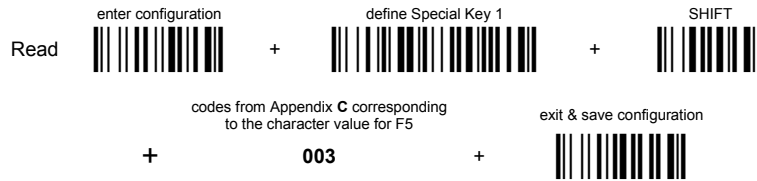

2. The following example allows defining Special Key 2 as CTRL + S (upper case):

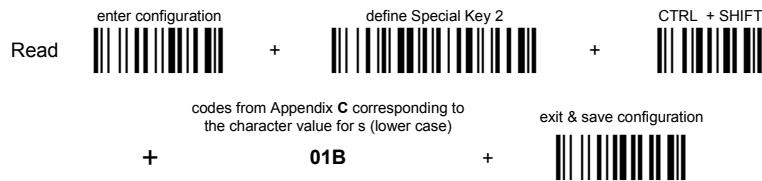

3. The following example allows defining Special Key 3 as Alt + F6:

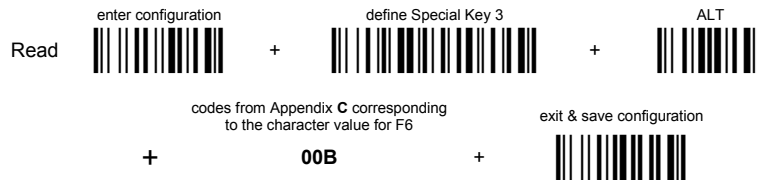

4. The following example allows defining Special Key 4 as Alt + Shift + F1:

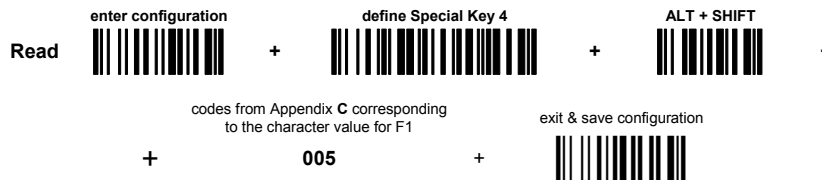

- Integrating Special Keys in Headers/Terminators -

1. the following example allows setting Special Key 1 (defined in example 1 above) as terminator:



2. the following example allows setting Special Key 2 (defined in example 2 above) as header:



3. the following example allows setting Special Key 3 (defined in example 3 above) as header:



4. the following example allows setting Special Key 4 (defined in example 4 above) and ENTER character as terminators:



5.3.3 Address Stamping

It is possible to include the reader address in the message sent to the host. The Reader Address Stamping and the Cradle Address Stamping parameters consist of 12 hex characters. For message output format, refer to chapter 6.

5.3.4 Address Delimiter

The Address Delimiter allows a character to be included to separate the reader Address stamping field from the next field in the message. Any character can be included in the hexadecimal range from 00 to FE. For message output format, refer to chapter 6.

5.3.5 Time Stamping Format

The Time Stamping parameter sets the format for hour and date information. It consists of 1 or 2 groups of numbers, each one made up of 6 decimal digits.

For example, setting the Hour/Minutes/Seconds/Month/Day/Year format, the information *17:03:16 on June 12, 2002* will be formatted as 170316061202.

5.3.6 Time Stamping Delimiter

The Time Stamping Delimiter allows a character to be included to separate the Time Stamping field from the next field in the message. Any character can be included in the hexadecimal range from 00 to FE.

5.4 Power Save

5.4.1 Sleep State

When using interfaces other than USB, this mode allows the μ P in the reader to enter a "Sleep" state for minimum power consumption.

Before entering Sleep mode, the following are verified:

- no commands coming from Host
- no data being transmitted to Host
- Enter Sleep Timeout ended (see par. 5.4.2)

To exit Sleep mode press the trigger.

For BT8300 series readers, sleep state is entered immediately after reading a code and is not configurable. To exit Sleep mode press the trigger.

When using the USB interface, this mode allows the device to manage Selective Suspend conditions generated by the Host Operating System in which optimizing low power consumption (ex. Windows Stand-by). It is possible to exit the Suspend mode either from the Host (ex. moving the mouse during Stand-by) or through the barcode reader. The latter, called Remote Wakeup, makes the device wake up the Host restoring the communication. Remote Wakeup is possible by pressing the trigger.

5.4.2 Enter Sleep Timeout

For readers that have the Sleep state enabled, this timeout determines when the reader will enter this state.

5.5 Reading Parameters

5.5.1 Trigger Signal

This mode determines how the reading phase is controlled when the hardware trigger operating mode is selected:

- trigger active level: the reader goes ON when the trigger is pressed and goes OFF when it is released
- trigger active pulse: the reader goes ON at the first trigger press and goes OFF only at a second press

5.5.2 Trigger Click

When enabled, it activates a "click" sound upon each trigger pressure.

5.5.3 Trigger-Off Timeout

When this timeout is selected, the reader turns OFF automatically after the desired period of time.

5.5.4 Reads per Cycle

In general, a **reading cycle** corresponds to the ON + OFF times of a device.

The resulting effects of this parameter on code reading depend on other related configuration conditions. Here are the definitions of ON and OFF times.

- For readers using the software trigger parameter (FLASH MODE), a reading cycle corresponds to the *flash on* + *flash off* times. Code reading takes place during the *flash on* time.
- For readers using the *hardware trigger* parameter, a reading cycle corresponds to a trigger press (ON) + one of the following OFF events:
 - trigger release (for *trigger active level*)
 - a second trigger press (for *trigger active pulse*)
 - trigger-off timeout* (see par. 5.5.3).

When **one read per cycle** is selected, the device decodes only one code during the ON period and immediately turns the reader OFF. It is only possible to read another code when the next ON time occurs.

In **multiple reads per cycle**, the ON period is extended so that the device can continue decoding codes until an OFF event occurs. For software trigger mode, the *flash on* period is immediately reset after each read and therefore extended. If another code is decoded before the reset *flash on* period expires, it is again reset and the effect is that the device remains ON, decoding codes until the *flash on* or *timeout* period expires.

The Safety Time parameter should be used in this case to avoid unwanted multiple reading of the same code, see par. 5.5.5.

5.5.5 Safety Time

Safety time prevents the device from immediately decoding the same code more than once. Same code consecutive reading can be disabled requiring the reader to be removed from the code (no decoding) for at least 400 ms, or a timeout can be set up to 9.9 seconds before the decoder will accept the same code. Reading is immediate if the code changes. The safety time parameter is not applicable when reading stacked codes or when setting one read per cycle in hardware trigger operating mode, since these settings require voluntary action by the user.

5.6 Decoding Parameters

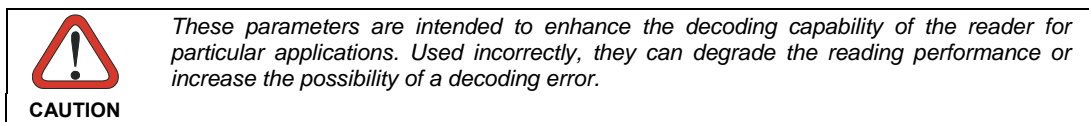

5.6.1 Ink-Spread

The ink-spread parameter allows the decoding of codes, which are not perfectly printed because the page texture tends to absorb the ink.

5.6.2 Overflow Control

The overflow control parameter can be disabled when decoding codes printed on small surfaces, which do not allow the use of an overflow space.

This command does not affect code families 2/5, Code 128 and Code 93.

5.6.3 Interdigit Control

The interdigit control parameter verifies the interdigit spacing for code families Code 39 and Codabar.

5.7 Advanced Formatting

5.7.1 Match Conditions

Selecting an Advanced Formatting and specifying a Match restriction (Code Type, Code Length, Predefined Characters) the code will be transmitted according to the order of the defined formats.

For example, defining 2 formats where:

- Format 1: Match Code type = Code128
- Format 2: Match Code length = 15 and Match with Predefined Characters "DATA"

a Code128 "DATA:12345ABCDE" with code length 15 will be formatted following the Format 1.

To send the same code with the Format 2 it is necessary to invert the format order as follows:

- Format 1: Match Code length = 15 and Match with Predefined Characters "DATA"
- Format 2: Match Code type = Code128

5.8 Radio Parameters

5.8.1 Power-Off Timeout

If this command is enabled, after the desired timeout in hours, the PowerScan™ batteries are disconnected and all power consumption ceases. To restore power, press the trigger once. The reader will now be ready to read codes.

Power-off does not affect configuration parameters.

5.8.2 Beeper Control for Radio Response

For BT8300 series readers, the data entry good read tone normally results in two beeps; the first indicates that the reader has decoded the code; the second indicates whether BC 8030-BT has received the data.

This can be changed according to the following selections:

- ◆ Normal: both good decode and good receptions are signaled (two beeps).
- ◆ Only Good Decode: only the first beep indicating a good read is signaled.
- ◆ Only Good Reception: only the second beep indicating a good reception is signaled.
- ◆ Off: Neither good read nor good reception beeps are signaled.

For all configurations, any transmission errors will always be signaled.

5.8.3 Batch Mode

This Operating Mode allows storing read codes in the internal reader memory. The stored codes are transmitted to the base station at a later time according to the type of batch mode selected.

Batch mode can be enabled either manually (normal batch mode) or automatically.

Normal batch mode temporarily suspends radio communication between reader and base station allowing codes to be stored in the reader on a FIFO (first in, first out) basis. This can be useful, for example, if codes must be read from a location where there is no radio network. Upon returning to the system working area, this mode requires reading the **Start Normal Batch Transmission** barcode to successively transmit the list of stored codes to the base station. The FIFO management assures that the first code read will be the first code to be transmitted to the base station.

The **Delete Batch Data** barcode allows canceling all barcode data stored in the reader.

Automatic batch mode allows codes to be stored in the reader on a FIFO basis whenever the reader is out of radio range. In this case radio communication is not suspended and transmission is attempted after each code read. If transmission cannot be successfully completed, then the code is added to the list. When the reader returns in range, transmission of the codes to the base station resumes automatically, according to the selected communication protocol, upon simply pressing and releasing the trigger or by successfully reading a new code.

3-KEY MODEL

Each code is listed on the reader display together with its identifying position number and its total number of characters. The three keys under the display have the following function in batch mode:

	Key	Function
	▲ (left) Key	Scroll up in list
ENTER	(center) Key	Delete highlighted code
	▼ (right) Key	Scroll down in list

The code which has a transmission pending is shown on the display in reverse video, indicating that it cannot be deleted.

16-KEY DK MODEL

If the 'Enable Normal Batch' barcode is read, the FUNCTION KEY1 (F1) is automatically re-configured to toggle between the two different operative modes described in the following paragraphs. The mnemonic label associated to the F1 is Bat (abbreviation of batch).

Operative modes:

- **INSERT MODE** – this is the common data entry mode and will reflect the operative mode of the system (Quantity Mode, Simple Data Input Mode). All data scanned via barcode or entered on the keyboard will be batched in the persistent memory. Functions keys F2 - F4 maintain their programmed functions.
- **SCROLL MODE** – in this mode the user can see and can delete previously inserted data. The action of the function keys changes to reflect the different user mode. It will be:

Function Key	Action	Label
F1	toggles between INSERT MODE and SCROLL MODE	Bat
F2	Scroll up	↑
F3	deletes the currently shown data from the batch	Del
F4	Scroll down	↓

After pressing F1 again, the operative mode moves back to "Insert Mode" and the function keys F2-F4 are returned to their originally programmed functions.

Note that the 16-key DK saves the automatic batch in RAM, while the normal batch mode saves to Flash. When entering normal batch mode on the 16-key via programming label, the display shows the message "Flash Erase" to describe the initialization.

5.8.4 See Me

When this feature is enabled, if the PowerScan BT8300 is not used for a few minutes it enters standby mode and its green LED starts blinking in order to signal its location.

5.9 BLUETOOTH PARAMETERS

About Bluetooth Profile Support

A Bluetooth profile is a wireless interface specification for Bluetooth-based communication between devices. In order to use Bluetooth technology, a device must be compatible with the subset of Bluetooth profiles necessary to use the desired services. The profiles provide standards which manufacturers follow to allow devices to use Bluetooth in the intended manner.

With Bluetooth Profile Support, the BC 8030-BT cradle is not required for wireless communication. The PowerScan BT8300 reader communicates directly to the host using Bluetooth technology. The PowerScan BT8300 supports the standard Bluetooth Serial Port Profile (SPP) and HID Profile, which enables the scanner to communicate with other Bluetooth-Enabled devices that support these profiles.

- **SERIAL PORT PROFILE** – The reader connects to the Bluetooth-Enabled PC and emulates a serial cable to provide a simple substitute for existing RS-232, including the familiar control signals.
- **HID PROFILE** - The reader connects to the Bluetooth-Enabled PC and emulates a virtual keyboard on the Host.

5.9.1 Communication Type

The PowerScan BT8300 reader can be configured to work with BC 8030-BT cradle, or to use standard Bluetooth profiles based on your Communication Type selection:

- **HANDHELD – CRADLE** (*default*): Select this communication type to configure the PowerScan BT8300 reader to work with the BC 8030-BT cradle. The reader must be paired to the cradle and the cradle must connect directly to the Host via multi-interface port.
- **SERIAL PORT PROFILE** (*Master*): Select this communication type for Bluetooth Profile Support. The scanner connects to the Bluetooth-Enabled PC and behaves like there's a serial connection. The scanner initiates the connection to the remote device and acts as the Master.
- **SERIAL PORT PROFILE** (*Slave*): Select this communication type for Bluetooth Profile Support. The scanner connects to the Bluetooth-Enabled PC and behaves like there's a serial connection. The scanner accepts an incoming connection requested from a remote device and acts as the Slave.
- **HID PROFILE**: Select this communication type for using Bluetooth Profile Support. The scanner connects to the PC/host via Bluetooth and behaves like a keyboard.

5.9.2 Link By Contact

Link by Contact allows the PowerScan BT8300 reader to connect to the BC 8030-BT cradle when the reader is inserted in the cradle. After scanning Enable Link by Contact, firmly position the reader onto the cradle. The BC 8030-BT cradle will emit a beep and the yellow LED will blink while the cradle is trying to establish the connection. If the connection is successful, four ascending beeps will be emitted and the yellow LED on the cradle will stop blinking; If the connection fails, four descending beeps will be emitted and the yellow LED on the cradle will also stop blinking.

5.9.3 Link By Label

In addition to the procedure shown on page 16, you can create a linking barcode for the BC 8030-BT or Bluetooth-Enable PC to which PowerScan BT8300 can connect. You must know the Bluetooth address of the remote device. Linking bar codes are Code 128 with the following format:

\$+QSxxxxxxxxxxxxx\$-

\$+QHxxxxxxxxxxxxx\$-

With

- QS – Scanner is working in Handheld-Cradle or Serial Port Profile (Master).
- QH – Scanner is working in HID profile.
- xxxxxxxxxxxx represents the 12-character Bluetooth address.

Example: Linking Bar Code

If the scanner is configured as SPP Profile (Master) and the remote device to which the scanner can connect has a Bluetooth address of 04:10:19:87:AB:CD, then the linking barcode will be:

\$+QS04101987ABCD\$-



5.9.4 Start Up Connect

When the PowerScan BT8300 is in Handheld-Cradle, Serial Port Profile (Master) or HID Profile mode, scanning Enable Start Up Connect will allow the PowerScan BT8300 reader to auto-connect with the paired device when the reader starts up. The paired device is the device to which PowerScan BT8300 reader makes connection successfully in each Communication Type.

The paired device information will automatically be deleted from the PowerScan BT8300 if the reader is restored to factory settings, changes power class, changes communication types or if unpairing is performed.

The green LED on the reader will blink when it tries to make the start up connection. If the connection is successful, four ascending beeps will be emitted and the green LED will stop blinking; Otherwise, four descending beeps will be emitted.

5.9.5 Auto Reconnect

When the PowerScan BT8300 is in Handheld-Cradle, Serial Port Profile (Master) or HID Profile mode, if Auto Reconnect is enabled the reader will automatically attempt to reconnect to a paired device after a disconnection occurs due to the radio losing communication. This can happen if the reader goes out of range with the paired device, or if the paired device powers down. The reader makes the reconnection attempt for the period of time specified by the Reconnect Attempt Interval and Reconnect Attempt Mode settings.

The green LED on the reader will blink as it attempts to make the reconnection. If the connection is successful, four ascending beeps will be emitted and green LED will stop blinking. If the reconnection process fails due to a page timeout, four descending beeps will be emitted.

5.9.6 Reconnect Attempt Interval

When the PowerScan BT8300 reader disconnects as it goes out of range or the remote device is powered down, the BT8300 immediately attempts to reconnect for the time interval specified using Time Reconnect. This time interval can be set to one of the following options:

- 1 minute (default)
- 5 minutes
- 30 minutes
- Indefinitely

5.9.7 Reconnect Attempt Mode

When the time specified by the Reconnect Attempt Interval setting expires without making a connection, it will restart a reconnect attempt either By Trigger or Do Not Attempt, depending on Reconnect Attempt Mode setting.

- By Trigger (default)
- Do Not Attempt

5.9.8 Power Class

The PowerScan BT8300 reader can work with two different types of radio power ranges:

- Class 1 = Exceeds 90 m / 295 ft radio range (default)
- Class 2 = Exceeds 40 m / 131 ft radio range.

Longer ranges require higher power radios, and consume more battery power for operation.

5.9.9 Security Mode

The PowerScan BT8300 reader supports Bluetooth Authentication and Encryption. Authentication can be requested by either the remote device or the scanner. When Authentication is requested, the scanner uses its programmed PIN code to generate a link key. The scanner stores this link key upon pairing, so you do not have to re-enter the PIN code when moving in and out of range, switching profiles, or switching between devices (e.g., between the cradle and the application). The PowerScan BT8300 reader can be configured to work in one of three security modes that enforce security at different levels:

- **Security Mode 1 – Authentication Disable and Encryption Disable**
- **Security Mode 2 – Encryption Disable and Authentication Enable**
- **Security Mode 3 – Encryption Enable and Authentication Enable**

5.9.10 PIN Code & PIN Length

When the PowerScan BT8300 reader is in Security Mode 2 or Security Mode 3, the PIN code is required to authenticate the connection between the reader and the cradle (in Handheld – Cradle type) or with the Bluetooth-Enabled PC (in Serial Port Profile and HID profile).



The mandatory condition for establishing a new connection between a BT reader and a BT cradle or Bluetooth-Enabled PC is that they share the same security configuration and have the same PIN code.

NOTE

The default PIN code in PowerScan BT8300 reader is **1234**. The PIN code can be changed to either of two length options:

- PIN length = 4 (default).
- PIN length = 16

5.9.11 Variable PIN Code

By default PowerScan BT8300 will automatically use a **Static PIN Code** in response to the authentication connection from the Host. However, some Bluetooth drivers on the Host (such as WIDCOMM and BlueSoleil 8.0.338.0) require a **Variable PIN Code**. When attempting connection, the application presents a window that includes a PIN Code which is to be input using the PowerScan BT8300. When you hear the beep indicating the reader is waiting for an alphanumeric entry, enter the provided variable PIN Code one of two ways:

1. **Keypad** (PBT8300 16-key DK only): type the PIN Code on the scanner keypad, then tap **Enter** (←).
2. **Scanning**: read the barcode corresponding with the require PIN Code and ending with **Exit and Save configuration** label. Use the labels in the **HEX/NUMERIC KEYPAD** section for alphanumeric entry.

5.9.12 HID Caps Lock Auto-Recognition (IBM AT-Compatible Only)

This option applies only to the HID Profile. When enabled, the case of the data is preserved regardless of the state of the caps lock key on the Bluetooth – Enabled Host.

5.9.13 HID Alt Mode

The HID ALT Mode selection allows barcodes sent to the PC to be interpreted correctly independently from the HID Country Code used. An HID Country Code does not need to be selected.



Ensure that the Num Lock key on the keyboard is ON when in HID ALT mode is enabled.

NOTE

5.9.14 HID Interchar Delay

This parameter sets the delay, in milliseconds, between emulated keystrokes in HID Profile. The allowed delay can be set from 0 milliseconds (disabled) up to 99 milliseconds.

5.9.15 HID Send Unknown ASCII Character

Unknown characters are characters the host does not recognize. When *Disable HID Send ASCII Unknown character* is selected, all barcode data is sent except for unknown characters, and an error beep will sound. When *Enable HID Send ASCII Unknown character* is selected, an unknown character will be sent as a SPACE.

5.10 Display Parameters (Some BT8300 Models only)

5.10.1 Display Mode

The user can control the reader display behavior according to the following selections:

Normal mode: When a barcode is read with the reader:

- The code is sent to the Host.
- The reader display is not cleared. Therefore if any previous data was displayed on the reader screen it remains.
- There is no Local Echo to the reader display.

Clear Display After Decode mode: When a barcode is read with the reader:

- The code is sent to the Host.
- The reader display is cleared. Therefore if any previous data was displayed on the reader screen it is cancelled and the screen remains blank.
- There is no Local Echo of the code to the reader display.







Local Echo mode: When a barcode is read with the reader:

- The code is sent to the Host.
- The reader display is cleared.
- The code is also sent to the reader display (Local Echo).
- The cursor is positioned after the last printed character on the reader display.

Host messages sent to the reader are always written to the reader display.

5.11 Configuration Editing Commands

The following commands carry out their specific function and then exit the configuration environment.

Command	Description
	Restore PowerScan™ reader default configuration (see the relative Quick Reference Guide for default settings)
	Transmit the PowerScan™ BT8300 software release.
	Transmit PowerScan™ reader configuration in ASCII format. This command is not effective with Pen emulation interface.
	Restore BC 8030-BT default configuration (see the relative Quick Reference Guide for default settings)
	Transmit the BC 8030-BT Software release.
	Transmit BC 8030-BT configuration in ASCII format. This command is not effective with Pen Emulation interface.

5.12 Custom Default Configuration

Read the following code to set the reader user-defined configuration as custom default configuration:

Save User-defined Configuration as Custom Default



Read the following code whenever you need to restore the custom default configuration:

Restore Custom Default Configuration



5.13 Code Type Recognition

This procedure allows the reader to enter a particular state during which it reads and transmits to the Host information about the family type of codes unknown to the user (with the exception of MSI, Code 49 and Code 16k code types). It is also possible to read and transmit configuration strings without interpreting them. All codes are read ignoring the check digit.

Follow the given procedure:

- ① Read the following code to enter the code type recognition mode:



- ② Read existing codes whose family type you need to check.
- ③ Read the following code to return to the reader's normal functioning:

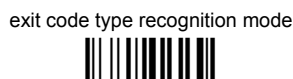

5.14 Configuration Copying Commands

5.14.1 Copy PowerScan™ BT8300 Series

Procedure:

- ① Using the slave reader and its BC 8030-BT cradle, follow the initialization procedure in this manual or from the Quick Reference Guide.
- ② With the master PowerScan™ BT8300 (correctly configured reader), read the Copy Configuration barcode below. Then place it onto an BC 8030-BT cradle within 10 seconds. The reader will beep indicating the configuration has been copied.

The configuration will be simultaneously sent over the RS-232 interface of the BC 8030-BT. If this causes undesired effects disconnect the RS-232 cable between the PC and BC 8030-BT during this process.



- ③ With the slave PowerScan™ BT8300, read the Get Configuration barcode below. Then place it onto the same BC 8030-BT cradle used in the step above. The slave reader's address will not be changed.



The configuration will be copied from the master to the slave PowerScan™ BT8300. The slave PowerScan™ BT8300 signals the end of the procedure with a series of beeps. It is now ready to be used with its own BC 8030-BT cradle.

- ④ Repeat the procedure above to configure other slave readers. The BC 8030-BT can continue to configure slave readers until it receives another command or data.

5.14.2 Copy BC 8030-BT

Procedure:

- ① Using the **slave** reader and its BC 8030-BT cradle, read the Restore Default barcode, set the radio address, and then read the RS-232 interface barcode in this manual or from the Quick Reference Guide.

- ② Connect the **master** BC 8030-BT and the **slave** BC 8030-BT (cradle to be configured) together through two RS-232 serial interface cables and external power supply. Accessory cables and power supply are available from your Datalogic distributor to provide this connection.

RS-232 Cables: CAB471 & CAB472

Power Supply: PG12

- ③ Read the Configuration Copy barcode below with a reader. Then place it onto the **master** BC 8030-BT cradle.

Copy Configuration



The configuration will be copied from the master BC 8030-BT to the slave BC 8030-BT. The reader signals the end of the procedure with a series of beeps.

- ④ Repeat the procedure above to configure other slave cradles.

NOTE: The master BC 8030-BT can be configured for any interface.

5.15 Default Parameters for POS Terminals

The default values of the RS-232 and Data Format parameters for POS terminals are listed in the following table:

	NIXDORF Mode A	FUJITSU	ICL Mode
RS-232 Group			
Baud Rate	9600	9600	9600
Parity	Odd	None	Even
Data Bits	8	8	8
Stop Bits	1	1	1
Handshaking	Hardware (RTS/CTS)	None	RTS always ON
Inter-Character Delay	Disabled	Disabled	Disabled
Serial Trigger Lock	Disabled	Disabled	Disabled
Data Format Group			
Code Identifier	Custom	Custom	Custom
Header	No Header	No Header	No Header
Terminator	CR	CR	CR
Field Adjustment	Disabled	Disabled	Disabled
Code Length TX	Not Transmitted	Not Transmitted	Not Transmitted
Character Replacement	Disabled	Disabled	Disabled
Address Stamping	Disabled	Disabled	Disabled
Address Delimiter	Disabled	Disabled	Disabled
Time Stamping	Disabled	Disabled	Disabled
Time Delimiter	Disabled	Disabled	Disabled

The table below lists all the Code Identifiers available for the POS terminals:

CODE	NIXDORF Mode A	FUJITSU	ICL Mode
UPC-A	A0	A	A
UPC-E	C0	E	E
EAN-8	B	FF	FF
EAN-13	A	F	F
Code 39	M	None	C [code length]
Codabar	N	None	N [code length]
Code 128	K	None	L [code length]
Interleaved 2 of 5	I	None	I [code length]
Code 93	L	None	None
Industrial 2 of 5	H	None	H [code length]
UCC/EAN 128	P	None	L [code length]
MSI	O	None	None
GS1 DATABAR™	E	None	None
Other	None	None	None

5.16 Firmware Upgrade

Device firmware upgrades can be performed from your PC through a serial connection (RS-232). Download the free configuration software tool Aladdin from the Datalogic web site: <http://www.scanning.datalogic.com> and install it by clicking on the setup file.

Procedure:

1. Connect the device to the PC via USB cable or serial connection (RS-232).
2. Launch Aladdin on your PC. From the menu, select Tools > firmware upgrade.
3. Read the code below and position the reader onto the cradle:



Prepare device for firmware upgrade

4. Press the cradle button. The device will automatically reset.
5. Proceed with the firmware upgrade (see the Aladdin on-line help for details).



CAUTION

Do not interrupt firmware upgrade downloading for any reason.

5.17 16-Key PowerScan BT8300-DK Display and Keypad Parameters

5.17.1 16-key Keyboard Data Format Enable/Disable

The default Data Format is configured in the scanner system, and valid for all PowerScan models. They will be applied to the read barcode by the scanner. This is the typical method of configuration for all BT8300 models, including the BT8300-DK. Therefore, the Keyboard Data Format on the DK model does not overwrite or substitute for the default Data Format, but is potentially additional.

On the BT8300-DK the following configuration scenarios are available:

Keyboard Data Format= Disabled

- Scanner Data Header/Terminator = not null

Formatting is applied identically to a label read or data input from the keyboard (as programmed with Scanner Data Header/Terminator on page 146). Keypad Data Header/Terminator will be ignored in this case.

Keyboard Data Format= Enabled

- Scanner Data Header/Terminator = not null

Scanner Data Header/Terminator formatting is applied only to data received from a scanned barcode label (see page 146).

Keypad Data Header/Terminator formatting is applied only to data input from the keypad (see page 148).

In all the above cases Scanner Code ID and Scanner Code Length are not affected.

NOTE: This configuration item is part of the scanner configuration but is applied to the whole system. The configuration does not overwrite the default Data Format, but is additional.

5.17.2 Scanner Code ID

The default Data Format is valid for all BT8300 models. Code Identifier and Code Len TX (on pages 71,76 in this manual) are also valid for DK models. The item configuration is part of the cradle configuration and is applied to the scanner system.

Optionally, the DK 16-key scanner can be set for:

- Scanner Code ID
- Scanner Code Len TX
(with the same optional values as for standard formatting)

Differently from the other DK formatting, these two configuration items have priority over the corresponding standard formatting, and hide or substitute for them.

As a result the BT8300-DK can have the following configuration scenarios:

Scanner Code ID = Disable

The settings from the standard Code ID on page 71 will be used (if programmed).

Scanner Code ID = any different value from Disable (option 1,2,3 – Datalogic standard, AIM standard, or custom)

Use the specific DK Scanner Code ID instead of the standard Code ID. DK Scanner Code ID will be applied and will take priority over any standard Code ID settings, even if programmed.

5.17.3 Scanner Code Length

The behavior of Scanner Code Length is similar to that described above for Scanner Code ID.

As a result the BT8300-DK can have the following configuration scenarios:

Scanner Code Length = Disable

The settings from the standard Code Len TX on page 76 will be used (if programmed).

Scanner Code Length = any different value from Disable (variable digit format, fixed digit format)

Use the specific DK Scanner Code Length instead of the standard Code Len TX. Scanner Code Length will be applied and will take priority over any standard Code Len TX settings, even if programmed.

NOTE: Both of these configuration items are part of the scanner configuration but are applied to the whole system. The configuration item overwrites the default Data Format .

6 MESSAGE FORMATTING

6.1 Standard Message Formatting

The system always provides scanner to host data communication using the following message formatting:

<p>Output Message from <u>standard PowerScan™ BT8300 Towards Host</u></p> <p>[Header] [Scanner_Addr] [Scanner_Addr_delimiter] [Cradle_Addr] [Cradle_Addr_delimiter] [Time stamp] [Ts_delimiter] [Code ID] [Code Length] CODE [Terminator]</p> <p>[Items in square brackets are optional.]</p>
--

For PowerScan™ BT8300 models with display, if the RS-232 interface is selected for communication between the Host and the BC 8030-BT cradle, then the following additional communications between Host and Scanner can occur:

- The Host can send messages to any associated scanner, to control the Scanner's display, LEDs and beeper.
- The Scanner can send up to 3 user-defined characters using the command keys on the Scanner.

6.2 Advanced Message Formatting

The table below describes conventions and definitions used in the examples on the following page. In both the table and in the examples, formatting items valid only for the reader are shown in italics. The prefix C means the item is programmed from the BC 8030-BT cradle, and the prefix R means it is programmed from the PowerScan BT8300 reader.

<i>[R Header]</i>	It can be: <ul style="list-style-type: none"> o <i>[Reader Data Header]</i> or o <i>[Keypad Data Header]</i> depending on whether data is read from a barcode or typed on the keypad.
<i>[R Terminator]</i>	It can be: <ul style="list-style-type: none"> o <i>[Reader Data Terminator]</i> or o <i>[Keypad Data Terminator]</i> depending on whether data is read from a barcode or typed on the keypad.
[Code ID]	The optional Code ID formatting. It can be programmed: <ul style="list-style-type: none"> • From the BC 8030-BT cradle, represented in the following as [C ID] • from the PowerScan BT8300 reader, represented in the following as [R ID]
[Code len]	The optional Code len formatting. It can be programmed: <ul style="list-style-type: none"> • from BC 8030-BT cradle, represented in the following as [C len] • from the PowerScan BT8300 reader, represented in the following as [R len]

[C Header] [Reader_Addr] [Reader_Addr delimiter] [Cradle_Addr] [Cradle_Addr_delimiter] [Time Stamp] [Time Stamp Delimiter] <i>[R Header]</i> [Code ID] [Ccode len] CODE <i>[R Terminator]</i> [C Terminator]
--

Code ID, Code Length and Code can be different content in the reader. These features can be programmed with Reader Data Header/Terminator on page 121, or Keypad Data Header/Terminator on page 121.

Field code ID and Code length may also be programmed in the reader:

[C Header] [Reader Addr] [Reader Addr delimiter] [Cradle Addr] [Cradle Addr delimiter] [Time Stamp][Time Stamp Delimiter] [R Header] [C ID] [C len] CODE [R Term] [C Term]

[C Header] [Reader Addr] [Reader Addr delimiter] [Cradle Addr] [Cradle Addr delimiter] [Time Stamp][Time Stamp Delimiter] [R Header] [R ID] [R len] CODE [R Term] [C Term]

NOTE: in case of double formatting for [Code ID] [Ccode len], only one of these is included in message formatting. Specific Data Format [R ID] [R len] takes priority over general Data Format.

The code field [CODE] as additional formatting in the 16-key model, when the device is programmed in Qty/Code mode.

6.3 Messages from SCANNER Command Keys

6.3.1 PowerScan BT8300 keypad

The PowerScan™ BT8300 series scanners with display have 3 command keys that can each be associated with a character to send to the host.

By pressing the keys on the scanner, the associated character with its relative message formatting is sent to the Host. For example, keys can be used to select items from a menu sent to the scanner display by the application program.

The general format is:

[Header] [Reader_Addr] [Reader_Addr_delimiter]] [Cradle_Addr] [Cradle_Addr_delimiter] [Time stamp] [Ts_delimiter] [Code ID]
[Code Length] KeyID [Terminator]

[Items in square brackets are optional.]

The messages are handled by the system as if they were barcodes, that's why **KeyID** can have so many fields appended to it. If in your application there is some chance of reading a 1-char barcode identical to **KeyID**, the way you can distinguish between the two is to enable the Code ID: The **KeyID** is the only 1-character long EAN 8 code.

The default characters associated with each key (**KeyID**) are shown in the following table:

Default Key Identifiers		
	Key	KeyID
▲	(left) Key	'<'
ENTER	(center) Key	'='
▼	(right) Key	'>'

PowerScan BT8300-DK 16-key keypad

The 16-key keypad contains 4 programmable functions keys (see Function Key Programming on page 141 for more information). In addition, there is a Shift key which is used to access the alphabetic part of the keyboard, and an Enter key used to confirm “manually” input data.

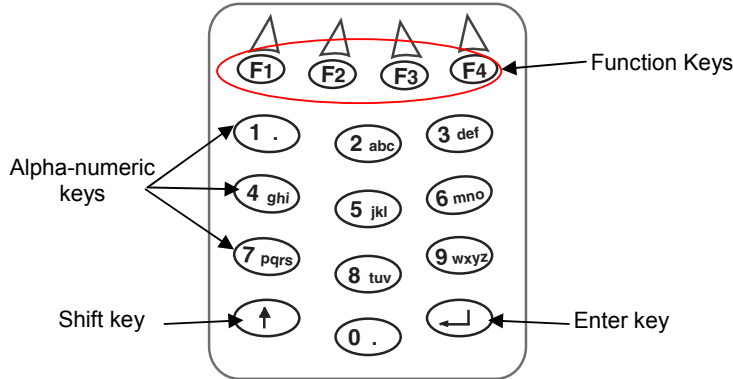

The 16-key keypad is organized like a cell phone, with multi-tap access to alpha characters on numeric keys. Press the keys once, twice, or more to cycle through the alpha letters and symbols until the desired character appears in the display.

The following table shows the key press options for each alphanumeric key:

Key	First Keypress	Second Keypress	Third Keypress	Fourth Keypress
1	.			
2	a	b	c	
3	d	e	f	
4	g	h	i	
5	j	k	l	
6	m	n	o	
7	p	q	r	s
8	t	u	v	
9	w	x	y	z

7 TECHNICAL FEATURES

7.1 PowerScan™ BT8300

Electrical and General Features		
Battery Type	2150 Li-Ion battery pack	
Recharge Time	max. 4 hours with external power supply max 10 hours with Host power	
Operating autonomy (continuous reading)	50,000 reads (typical)	
Display (Only available with some models)	LCD 4 lines x 16 chars Programmable font and backlight	
Indicators	Good Read LED (green) Good Read Spot (green), Beeper	
Laser Features	BT8300	BT8300 AR
Light Source	VLD between 630~680 nm	
Scan Rate	35 ± 5 scans/sec	
Power (max) in mW	0.9 mW	1.3 mW
Scan Angle	42°	13.5° ± 0.7
PCS minimum (Datalogic Test Chart)	15%	25%
Maximum Resolution	0.076 mm (3 mils)	0.19 mm (7.5 mils)
Reading Field Width	see reading diagrams (par. 7.5)	
Laser Safety Class	CLASS 2 EN 60825-1 / CDRH	
Bluetooth Features		
Protocol	Bluetooth 2.0; Class 1 or Class 2 configurable; SPP (Serial Port Profile) or HID (Human Interface Device) profile	
Radio Frequency	2.40 to 2.48 GHz	
Environmental Features		
Working Temperature	-20° to +50 °C / -4° to +122 °F	
Storage Temperature	-20° to +70 °C / -4° to +158 °F	
Humidity	90% non condensing	
Drop resistance (on concrete) IEC 68-2-32 Test ED	2 m	
Protection Class	IP65 (IP64 for models with display)	
Mechanical Features		
Weight (with batteries)	about 400 g (14.10 oz)	
Dimensions	212 x 109 x 71 mm (8.34 x 4.49 x 2.79 in)	
Material	Polycarbonate molded with rubber	
Keyboard	BT8300: no keyboard or display BT8300-D: 3 key keypad and display BT8300-DK: 16 key keypad and display	

7.2 BC 8030-BT

		BC 8030-BT
Electrical and General Features		
Supply Voltage		
	External Power	10 to 30 VDC
	Host Power	5 VDC ±10%
Power Consumption		
	External Power	max. 10 W (charging)*
	Host Power	max. 500 mA (charging)
Indicators		
Ext. Power /Data yellow LED Host Power/Data yellow LED Reader batt. state green/red LED		
Recharge Time		
	External Power	max. 4 hours with 2150 mAh Li-Ion battery
	Host Power	max. 10 hours with 2150 mAh Li-Ion battery
Host Interfaces		
	RS-232	300 to 38400 baud
	WEDGE	IBM AT or PS/2, XT, PC Notebook, IBM SURE1, IBM 3153, 31xx, 32xx, 34xx, 37xx terminals, Wyse terminals, Digital VT terminals, Apple ADB Bus supported
	PEN Emulation	Selectable minimum pulse from 200 μ S to 1.2 mS
	USB	USB-KBD, USB-KBD-ALT-MODE, USB-KBD APPLE, USB-COM, USB-IBM-Table Top, USB-IBM-Hand Held
Environmental Features		
	Working Temperature	-20° to +50 °C / -4° to +122 °F**
	Storage Temperature	-20° to +70 C / -4° to +158° F
	Humidity	90% non condensing
	Protection	IP40
Mechanical Features		
	Weight without cable	about 380 g / 13.4 oz
	Dimensions (without antenna)	204 x 108 x 95 mm / 9.44 x 4.25 x 3.74 in
	Material	ABS

* Having a switching regulator inside, the BC 8030-BT draws the same power, regardless of the supply voltage. i.e. as the input voltage increases the current drawn decreases.

** Batteries must be charged at a temperature ranging from 0° to +40 °C / +32° to +104 °F.

7.3 System CONFIGURATION

System Configuration	BC 8030-BT
Max number of devices per base station	4

7.4 Status Indicators

The scanner has two indicator LEDs and a Beeper. The BC-8000 and C-8000 cradles have four LED indicators (three for BC-8010 model) and a Beeper. They signal several operating conditions, which are described in the tables below.

H = high tone

L = low tone

POWERSCAN™ BT8300 READER START-UP

Beeper ¹	Meaning
L L L L	Parameters loaded correctly
H H H H long tones	Parameter loading error, reading or writing error in the non volatile memory
H L H L	Hardware error in EEPROM

POWERSCAN™ BT8300 READER CONFIGURATION

Beeper ¹	Meaning
H H H H	Correct entry or exit from Configuration mode
L	Good read of a command
L L L	Command read error

POWERSCAN™ BT8300 READER DATA ENTRY

Beeper ¹	LED	Good Read Spot	Meaning
one beep ²	ON	ON	Correct read of a code in normal mode
H L long			TX error between PowerScan™ BT8300 and BC-8030-BT
H long	ON	ON	Successful advanced format concatenation
H H H			Timeout expired – operation not completed
H H long			Error in advanced data formatting
	OFF	OFF	Ready to read a code

¹ Only the Beeper Intensity command can modify these signals.

² The data entry good read tone is user-configurable with all the Beeper commands in the Reading Parameters section.

For M-series readers, normally this results in two beeps; the first indicates that the reader has decoded the code, the second indicates whether BC 8030-BT has received the data. See also par. 5.8.2.

POWERSCAN™ BT8300 POWER

Beeper	LED	Meaning
10 short H	10 short blinks	Low Battery
H M L		Power off

H = high tone
M = medium tone
L = low tone

BC 8030-BT POWER/COMMUNICATION

Aux LED	Host LED	Meaning
Yellow	Yellow	
OFF	OFF	Device off
ON		Power applied through an external power supply
	ON	Power applied through the Host
Flashing	Flashing	Transmission over the Host port

BC 8030-BT CHARGE STATUS

Reader LED			Meaning
Red	Green	Beeper	
OFF	OFF		No reader battery inserted
ON			Reader battery in charge
	ON	single beep	Reader battery completely charged
Flashing orange			Reader battery fault
Alternating red/green		repetitive beep	Charging out of temperature range, over-current or over-voltage conditions
Alternating red/green every 30 seconds		beep every 30 seconds	Reader not correctly inserted onto cradle, no charging takes place
Spare LED (not for BC-8010)			Meaning
Red	Green	Beeper	
OFF	OFF		No Spare battery inserted in the SBS-3000 slot
ON			Spare battery in charge
	ON		Spare battery completely charged
Flashing orange			Spare battery fault
Alternating red/green		repetitive beep	Charging out of temperature range, over-current or over-voltage conditions
Alternating red/green every 30 seconds		beep every 30 seconds	Spare battery not correctly inserted into SBS-3000, no charging takes place

7.5 Reading Diagrams

Reading Distance

PowerScan™ BT8300

mil	Typical reading distance with good quality codes
5	2.1 - 13.3 cm / 0.8 - 5.2 in
7,5	3.5 - 24.2 cm / 1.4 - 9.5 in
10	2.9 - 42.8 cm / 1.1 - 16.8 in
13	2.3 - 55.1 cm / 0.9 - 21.7 in
20	6.3 - 78.5 cm / 2.5 - 30.9 in
40	2.5 - 97.8 cm / 1.0 - 38.5 in

PowerScan™ BT8300 AR

mil	Typical reading distance with good quality codes
7,5	18 - 50 cm / 7.0 - 19.7 in
10	18 - 85 cm / 7.0 - 33.5 in
15	15 - 165 cm / 5.9 - 65.0 in
20	12 - 210 cm / 4.7 - 82,7 in
40	18 - 375 cm / 7.0 - 147.6 in
55	25 - 485 cm / 9.8 in - 15.9 ft
100 (refl. Paper)	1.5 - 12.5 m / 4.9 ft - 41.0 ft

A HOST CONFIGURATION STRINGS

In this section we provide a description of how to modify the device configuration using serial strings sent from the Host.

This method requires the RS-232 interface.

The device configuration can be changed by receiving commands from the Host through the serial interface. When this method is used, the programming sequence format is the following:

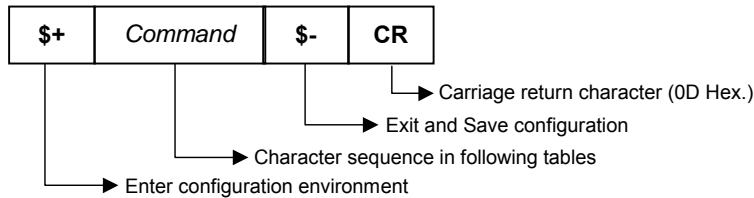

Example:

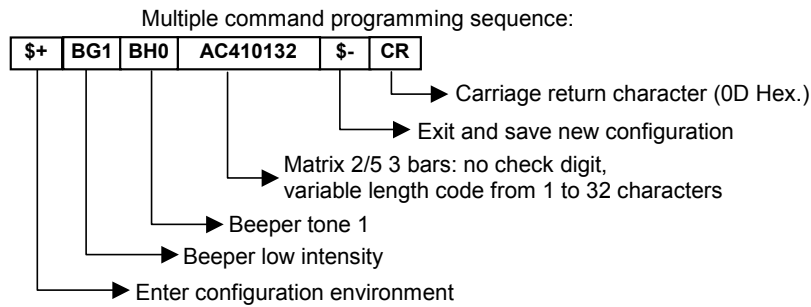

Each configuration parameter setting removes the condition previously active for that parameter.



NOTE

The device buffer can contain about 400 characters. If your programming string goes over this value, you must split it into separate groups and send each group after a delay of at least 3 seconds to give the reader time to empty the buffer and interpret the commands.

SERIAL CONFIGURATION STRINGS

SPECIAL CONFIGURATION COMMANDS	
DESCRIPTION	STRING
Enter Configuration	\$+
Exit and Save Configuration	\$-
Restore Default	\$\$*
Transmit Software Release (not for PEN emulation)	\$\$!
Transmit Device Configuration in ASCII (not for PEN emulation)	\$\$&
Set Custom Default	\$\$0
Restore Custom Default	\$\$1

These commands do not require \$-.

INTERFACE SELECTION		STRING
DESCRIPTION		
RS-232	Standard	CP0
	ICL Mode	CM0
	Fujitsu	CM1
	Nixdorf Mode A	CM2EC0
WEDGE	for IBM AT	CP500
	for IBM Terminals: 31xx, 32xx, 34xx, 37xx; make-break keyboard	CP501
	for IBM Terminals: 31xx, 32xx, 34xx, 37xx; make-only keyboard	CP502
	Keyboard Type for IBM typewriter	FK0
	Terminals 31xx, 32xx, 34xx, advanced	FK1
	37xx	
	for IBM XT	CP503
	for IBM Terminal 3153	CP504
	for IBM PC Notebook	CP505
	for IBM SURE1	CP506
	for IBM AT - ALT mode	CP507
	for IBM PC Notebook - ALT mode	CP508
	for Wyse Terminal - ANSI Keyboard	CP509
	for Wyse Terminal - PC Keyboard	CP510
for Wyse Terminal - ASCII Keyboard	CP511	
for Wyse Terminal - VT220 style Keyboard	CP514	
for Digital Terminals VT2xx/3xx/4xx	CP512	
PEN EMULATION		CP6
USB	USB-KBD	UA03
	USB-KBD-ALT-MODE	UA04
	USB-KBD-APPLE	UA05
	USB-COM	UA02
	USB-IBM-Table Top	UA00
	USB-IBM-Hand Held	UA01

RS-232		
DESCRIPTION		STRING
Baud Rate	300	CD1
	600	CD2
	1200	CD3
	2400	CD4
	4800	CD5
	9600	CD6
	19200	CD7
	38400	CD8
Parity	none	CC0
	even	CC1
	odd	CC2
Data Bits	7	CA0
	8	CA1
	9	CA2
Stop Bits	1	CB0
	2	CB1
Handshaking	disable	CE0
	RTS/CTS	CE1
	XON/XOFF	CE2
	RTS always On	CE3
Inter-character Delay (ms)		CK00 - CK99
Serial Trigger Lock	disable	CR0
	enable and select characters	CR1 ab

a = Hex values representing an ASCII character from **00** to **FE** enabling the device trigger.

b = HEX values representing an ASCII character from **00** to **FE** inhibiting the device trigger.

USB		
DESCRIPTION		STRING
USB-COM		
Handshaking	disable	CE0
	RTS/CTS	CE1
	XON/XOFF	CE2
	RTS always ON	CE3
Inter-character Delay (<i>ms</i>)		CK00 - CK99
Serial Trigger Lock	disable	CR0
	enable	CR1^a_b
USB-KBD		
Keyboard Nationality (not for USB-KBD-ALT-MODE)	Belgian	FJ7
	English (UK)	FJ4
	French	FJ2
	German	FJ3
	Italian	FJ1
	Spanish	FJ6
	Swedish	FJ5
	USA	FJ0
Keyboard Nationality (IBM AT compatible only)	Japanese	FJ8
	Russian (Latin)	FJ9
	Russian (Cyrillic)	FJA
	Hungarian	FJB
	Slovenian, Croatian, Serbian (Latin)	FJC
	Romanian	FJD
	Czech Republic	FJE
Delays	Inter-Character (<i>ms</i>)	CK00 - CK99
	Inter-Code (<i>s</i>)	FG00 - FG99
USB Keyboard Speed	normal	UT10
	fast	UT01

a = Hex values representing an ASCII character from **00** to **FE** enabling the device trigger.

b = HEX values representing an ASCII character from **00** to **FE** inhibiting the device trigger.

WEDGE		
DESCRIPTION		STRING
Keyboard Nationality	Belgian	FJ7
	English (UK)	FJ4
	French	FJ2
	German	FJ3
	Italian	FJ1
	Spanish	FJ6
	Swedish	FJ5
	USA	FJ0
Keyboard Nationality (IBM AT compatible only)	Japanese	FJ8
	Russian (Latin)	FJ9
	Russian (Cyrillic)	FJA
	Hungarian	FJB
	Slovenian, Croatian, Serbian (Latin)	FJC
	Romanian	FJD
	Czech Republic	FJE
Caps Lock	caps Lock ON	FE1
	caps Lock OFF	FE0
Caps Lock Auto-Recognition (IBM AT compatible only)	disable	FP0
	enable	FP1
Num Lock	toggle num lock	FL1
	num lock unchanged	FL0
Delays	Inter-Character (<i>ms</i>)	CK00 - CK99
	Inter-Code (<i>s</i>)	FG00 - FG99
Control Character Emulation	Ctrl + Shift + Key	FO0
	Ctrl + Key	FO1

PEN		
DESCRIPTION		STRING
Operating Mode	interpret (does not require \$+ or \$-)	\$]
	transparent (does not require \$+ or \$-)	\$[
Minimum Output Pulse	200µs	DG0
	400µs	DG1
	600µs	DG2
	800µs	DG3
	1 ms	DG4
	1.2 ms	DG5
Conversion to Code 39 and Code 128	disable conversion to Code 39 (D series only)	DA0
	enable conversion to Code 39	DA1
	enable conversion to Code 128 (M series only)	DA2
Output Level	normal	DD0
	inverted	DD1
Idle Level	normal	DE0
	inverted	DE1
Overflow	narrow overflow	DH0
	medium overflow	DH1
	wide overflow	DH2
Inter-block Delay (<i>100 ms</i>)		CK00-CK99

DATA FORMAT (NOT FOR PEN EMULATION INTERFACES)		
DESCRIPTION		STRING
Cradle Code Identifier	disable	EB0
	Datalogic standard	EB1
	AIM standard	EB2
	custom	EB3
Reader Code Identifier	disable	EZ0
	Datalogic standard	EZ1
	AIM standard	EZ2
	custom	EZ3
Custom Code Identifier		EHabc
Cradle Header	no header	EA00
	one character	EA01x
	two characters	EA02xx
	three characters	EA03xxx
	four characters	EA04xxxx
	five characters	EA05xxxxx
	six characters	EA06xxxxxx
	seven characters	EA07xxxxxxx
	eight characters	EA08xxxxxxxx
Reader Header	no header	EU00
	one character	EU01x
	two characters	EU02xx
	three characters	EU03xxx
	four characters	EU04xxxx
	five characters	EU05xxxxx
	six characters	EU06xxxxxx
	seven characters	EU07xxxxxxx
	eight characters	EU08xxxxxxxx
Cradle Terminator	no terminator	EA10
	one character	EA11x
	two characters	EA12xx
	three characters	EA13xxx
	four characters	EA14xxxx
	five characters	EA15xxxxx
	six characters	EA16xxxxxx
	seven characters	EA17xxxxxxx
	eight characters	EA18xxxxxxxx
Reader Terminator	no terminator	EU10
	one character	EU11x
	two characters	EU12xx
	three characters	EU13xxx
	four characters	EU14xxxx
	five characters	EU15xxxxx
	six characters	EU16xxxxxx
	seven characters	EU17xxxxxxx
	eight characters	EU18xxxxxxxx
Special Keys	Key 1	9C
	Key 2	9D
	Key 3	9E
	Key 4	9F
	Key 5	A0
Field Adjustment	disable	EF0
	right addition	EFa0d
	left addition	EFa1d
	right deletion	EFa2d
	left deletion	EFa3d

Field Adjustment Character		EGe
Cradle Code Length	disable	EE0
	variable digit format	EE1
	fixed digit format	EE2
Reader Code Length	disable	EX0
	variable digit format	EX1
	fixed digit format	EX2
Character Replacement	disable character replacement	EO0
	first character replacement	EO1afg
	second character replacement	EO2afg
	third character replacement	EO3afg
Address Stamping	disable reader address stamping	QA0
	enable reader address stamping	QA1
	disable cradle address stamping	Qa0
	enable cradle address stamping	Qa1
Address Delimiter	disable reader address delimiter	QF0
	enable reader address delimiter and select character	QF1h
	disable cradle address delimiter	Qf0
	enable cradle address delimiter and select character	Qf1h
Time Stamping	disable	IL0
	hour/minutes/seconds/month/day/year	IL1
	hour/minutes/seconds/day/month/year	IL2
	hour/minutes/seconds	IL3
	month/day/year	IL4
	day/month/year	IL5
Time Stamping Delimiter	disable time stamping delimiter	IMS0
	enable time stamping delimiter	IMS1
	select time stamping delimiter character	IM1h

a = ASCII character.

b, c, x = HEX values representing an ASCII character.

a = ASCII character of the DATALOGIC STANDARD Code Identifier from the table on page 42.

b = Hex value of the first Custom Code Identifier character from **00** to **FD**;
FF = disable Code Identifier

c = Hex value of the second Custom Code Identifier character from **00** to **FD**;
FF = disable second character of Custom Code Identifier

d = a number in the range **01-32** from the Hex/Numeric Table

e = Hex value from **00** to **FE**

f = Hex value of the character to be replaced from **00** to **FE**

g = Hex value of the new character to insert from **00** to **FE**
FF = replace with no new character (remove character)

h = a HEX value in the range from **00** - **FE** representing the ASCII character.

x = Hex value from **00** to **FE**

POWER SAVE		
DESCRIPTION		STRING
Sleep State (only for D8330 series)	disable	BQ0
	enable	BQ1
Enter Sleep Timeout (100 ms)		BR00-BR99

READING PARAMETERS		
DESCRIPTION		STRING
Trigger Type	software trigger	BK0
	hardware trigger	BK1
	always on	BK3
Trigger Signal	trigger active level	BA0
	trigger active pulse	BA1
Trigger Click	disable	Bc0
	enable	Bc1
Trigger-off Timeout (s)		BD00 - BD99
FLASH ON (100 ms)		BB001 - BB099
FLASH OFF (100 ms)		BB101 - BB199
Reads per Cycle	one read	BC0
	multiple reads	BC1
Safety Time (100 ms)		BE00 - BE99
Beeper Intensity	very low intensity	BG0
	low intensity	BG1
	medium intensity	BG2
	high intensity	BG3
Beeper Tone	tone 1	BH0
	tone 2	BH1
	tone 3	BH2
	tone 4	BH3
Beeper Type	monotone	BJ0
	bitonal	BJ1
Beeper Length	long	BI0
	short	BI1
Good Read Spot Duration	disable	BV0
	short	BV1
	medium	BV2
	long	BV3
Aiming System	disabled	Bj0
	enabled	Bj1
Cradle Beeper Intensity	disable	JI0
	low intensity	JI1
	medium intensity	JI2
	high intensity	JI3

DECODING PARAMETERS		
DESCRIPTION		STRING
Ink-spread	disable	AX0
	enable	AX1
Overflow Control	disable	AW1
	enable	AW0
Interdigit Control	disable	AV0
	enable	AV1
Puzzle Solver™	disable	AU0
	enable	AU1
Decoding Safety	one read	ED0
	two reads	ED1
	three reads	ED2
	four reads	ED3

CODE SELECTION			STRING	
DESCRIPTION				
DISABLE ALL FAMILY CODES			AZ0	
EAN/UPC	disable EAN/UPC family		AA0	
	EAN 8/EAN 13/UPC A/UPC E	without ADD ON	AA1	
		with ADD ON	AA5	
		with and without ADD ON	AA8	
	EAN 8/EAN 13	without ADD ON	AA3	
		with ADD ON 2 ONLY	AAK	
		with ADD ON 5 ONLY	AAL	
		with ADD ON 2 AND 5	AA6	
	UPC A/UPC E	without ADD ON	AA4	
		with ADD ON 2 ONLY	AAM	
		with ADD ON 5 ONLY	AAN	
		with ADD ON 2 AND 5	AA7	
	EAN/UPC with and without Add On no Autodiscrimination			AA8Ad0
	EAN/UPC Autodiscrimination Add On by Prefix			AA8Ad1
	Select Prefixes	cancel all selections		ET0
		378/379		ET1378ET23 79
		434/439		ET3434ET44 39
		414/419		ET5414ET64 19
		977		ET7977
		978		ET8978
		979		ET9979
	EAN 8 check digit transmission	disable		AAG0
		enable		AAG1
	EAN 13 check digit transmission	disable		AAH0
		enable		AAH1
	UPC A check digit transmission	disable		AAI0
		enable		AAI1
	UPC E check digit transmission	disable		AAJ0
		enable		AAJ1
	conversions	UPC E to UPC A		AAA
		UPC E to EAN 13		AAB
		UPC A to EAN 13		AAC
		EAN 8 to EAN 13		AAD
ISBN Conversion codes	enable ISBN		AP1	
	enable ISSN		AP2	
	enable ISBN and ISSN		AP3	
	disable ISBN and ISSN		AP0	
Code 39	disable Code 39 family		AB0	
	Standard	no check digit control	AB11	
check digit control and transmission		AB12		
check digit control without transmission		AB13		
Full ASCII	no check digit control	AB21		
	check digit control and transmission	AB22		
	check digit control without transmission	AB23		

CODE SELECTION (continued)			
DESCRIPTION			STRING
	CIP 39		AB3
	Code 32		AB4
	code length		AB*xxxx
2/5	disable Code 2/5 family		AC0
	Interleaved 2/5	no check digit control	AC11xxxx
		check digit control and transmission	AC12xxxx
		check digit control without transmission	AC13xxxx
	Normal 2/5 5 bars	no check digit control	AC21xxxx
		check digit control and transmission	AC22xxxx
		check digit control without transmission	AC23xxxx
	Industrial (IATA) 2/5	no check digit control	AC31xxxx
		check digit control and transmission	AC32xxxx
		check digit control without transmission	AC33xxxx
	Matrix 2/5 3 bars	no check digit control	AC41xxxx
		check digit control and transmission	AC42xxxx
		check digit control without transmission	AC43xxxx
	CIP/HR		AC5
Codabar	disable Codabar family		AD0
	Standard	no start/stop character equality control nor transmission	AD111
		no start/stop character equality control but transmission	AD112
		start/stop character equality control but no transmission	AD121
		start/stop character equality control and transmission	AD122
	ABC Codabar	no start/stop character equality control but transmission	AD212
	Codabar ABC forced concatenation		AD232
	code length		AD*xxxx
	start/stop character case in transmission	lower case	ADA0
		upper case	ADA1
Code 128	disable Code 128 family		AI0
	enable Code 128 - control without transmission of check digit		AI11
	enable EAN 128 - control without transmission of check digit		AI21
	Transmit GS before Code	disable	EQ0
		enable	EQ1
	ISBT 128	enable ISBT 128	AI31
	code length		AILxxxx
Code 93	disable Code 93 family		AK0
	enable Code 93 - control without transmission of check digit		AK1

xxxx = ASCII numbers that define the code length where:

- First 2 digits = minimum acceptable code length.
- Second 2 digits = maximum acceptable code length.

The minimum code length must always be less than or equal to the maximum.

The maximum code length for all codes is 99 characters:

Examples:

0132 = variable length from 1 to 32 digits in the code.

1010 = 10 digit code length only.

CODE SELECTION (continued)		
DESCRIPTION		STRING
MSI	disable the family	AE0
	no check	AE1
	MOD10 no tx	AE2
	MOD10 with tx	AE3
	MOD11-MOD10 no tx	AE4
	MOD11-MOD10 with tx	AE5
	MOD10-MOD10 no tx	AE6
	MOD10-MOD10 with tx	AE7
Code 11	disable the family	AG0
	no check	AG1
	Type C with tx	AG21
	Type C no tx	AG22
	Type K with tx	AG31
	Type K no tx	AG32
	Type C and K with tx	AG41
	Type C and K no tx	AG42
Code 16K	disable	AJ0
	enable	AJ1
Code 49	disable	AM0
	enable	AM1
GS1 DataBar™ Codes	disable the family	AQ0
	disable GS1 DataBar Expanded Linear and Stacked	AQ10
	enable GS1 DataBar Expanded Linear and Stacked	AQ11
	disable GS1 DataBar Limited	AQ20
	enable GS1 DataBar Limited	AQ21
	disable GS1 DataBar Linear and Stacked	AQ30
	enable GS1 DataBar Linear and Stacked	AQ31

xxxx = ASCII numbers that define the code length where:

- First 2 digits = minimum acceptable code length.
- Second 2 digits = maximum acceptable code length.

The minimum code length must always be less than or equal to the maximum.

The maximum code length for all codes is 99 characters:

Examples:

0132 = variable length from 1 to 32 digits in the code.

1010 = 10 digit code length only.

RADIO PARAMETERS		
DESCRIPTION		STRING
Power-Off Timeout		RP00 RP99
Beeper Control For Radio Response	normal	BF0
	only good decode	BF1
	only good reception	BF2
	off	BF3
Batch Mode	disable	BZ0
	Enable normal batch	BZ1
	Enable automatic batch	BZ2
See Me	disable	Bk0
	Enable	Bk1

BLUETOOTH PARAMETERS		
DESCRIPTION		STRING
Communication Type	Handheld - Cradle	QT2
	Serial Port Profile (Master)	QT0
	Serial Port Profile (Slave)	QT1
	HID Profile	QT3
Bluetooth Friendly Name	Set Friendly Name	QNbb
Link by Contact	Enable	QD1
	Disable	QD0
Start Up Connect	Enable	QW1
	Disable	QW0
Auto Reconnect	Enable	QU1
	Disable	QU0
Reconnect Attempt Interval	1 minute	QY0
	5 minutes	QY1
	30 minutes	QY2
	Indefinitely	QY3
Reconnect Attempt Mode	By Trigger	QV1
	Do Not Attempt	QV0
Power Class	Reader Power Class 1	QZ0
	Reader Power Class 2	QZ1
	Cradle Power Class 1	Qz0
	Cradle Power Class 2	Qz1
Cradle Security mode	Security mode 1	Qb0
	Security mode 2	Qb1
	Security mode 3	Qb2
Reader Security mode	Security mode 1	QB0
	Security mode 2	QB1
	Security mode 3	QB2
PIN Length	Reader PIN Length = 4	QP0
	Reader PIN Length = 16	QP1
	Cradle PIN Length = 4	Qp0
	Cradle PIN Length = 16	Qp1
PIN Code	Set Reader PIN Code 4	QXhhh
	Set Reader PIN Code 16	QXhhhhhhhhhhhhhhhh
	Set Cradle PIN Code 4	Qxhhh
	Set Cradle PIN Code 16	Qxhhhhhhhhhhhhhhhh
Variable PIN Code	Static PIN Code	QQ1
	Variable PIN Code	QQ0
Discoverable Mode	Enable	QE1
	Disable	QE0

b= Read 2 numbers in the range 00-26 to define the Length + Read HEX characters to define Friendly Name

a= Read 12 characters to represent Host Bluetooth Address

h = Read HEX numbers to assign 4 or 16 PIN Code

BLUETOOTH PARAMETERS (continued)		
DESCRIPTION		STRING
HID Country Code	Country Code = U.S	QI00
	Country Code = Italy	QI01
	Country Code = France	QI02
	Country Code = Germany	QI03
	Country Code = Britain	QI04
	Country Code = Sweden	QI05
	Country Code = Spain	QI06
	Country Code = Belgium	QI07
	Country Code = Japanese 106-key	QI08
	Country Code = Poland	QI09
	Country Code = Hungary	QI0A
	Country Code = Croatia	QI0B
	Country Code = Romania	QI0C
	Country Code = Czech Republic	QI0D
Country Code = Slovakia	QI0E	
Country Code = Denmark	QI0F	
Country Code = Norway	QI10	
Country Code = Portugal	QI11	
Country Code = Switzerland	QI12	
HID Caps Lock State	Caps Lock OFF	QL0
	Caps Lock ON	QL1
HID Caps Lock Auto-Recognition (IBM AT compatible only)◦	Enable	QM1
	Disable	QM0
HID Alt Mode	Enable	QK0
	Disable	QK1
HID Interchar Delay (ms)	HID Interchar Delay	QJ00-QJ99
HID Send Unknown ASCII Char	Disable	QO0
	Enable	QO1

◦ = Read 2 numbers from the table where:
 00 = DELAY disable
 01-99 = DELAY from 1 to 99 milliseconds

DISPLAY PARAMETERS		
DESCRIPTION		STRING
Date		IAddmmyy
Time		IBhhmm
Contrast	lighter	IC0
	darker	IC1
Font Size	small	ID0
	medium	ID1
	large	ID2
Backlight	off	IE0
	on	IE1
Display-Off Timeout		IFa
Display Mode	normal	IG0
	local echo	IG1
	clear display after decode	IG2
Keypad	disabled keys	IK0
	enable and select KeyID characters	IK1bbb

ddmmyy = numbers from the Hex/Numeric Table representing day, month, year
hhmm = numbers from the Hex/Numeric Table representing hour, minutes
a = a number from the Hex/Numeric Table
b = HEX values representing an ASCII character

a = a number in the range **00-99** (sec.) from the Hex/Numeric Table
00 = Timeout disabled (always on).
b = 3 Hex values from **00** to **FE** representing the left, center and right keys.
FF = KeyID disabled.

DISPLAY PARAMETERS 16-Keys		
DESCRIPTION		STRING
Keypad Enable	Keypad Disabled	IS0
	Keypad Enabled	IS1
Interkey Timeout	0.5 sec.	BI0
	1 sec.	BI1
	1.5 sec.	BI2
	2 sec.	BI3
Key Press Sound	Disabled	IQ0
	Enabled	IQ1
Function Key Programming		INcx
String Table	no terminator	IPc0
	one character	IPc1b
	two characters	lpc2bb
	three characters	lpc3bbb
	four characters	lpc4bbbb
	five characters	lpc5bbbbb
	six characters	lpc6bbbbbb
	seven characters	lpc7bbbbbbb
	eight characters	lpc8bbbbbbbb
	nine characters	lpc9bbbbbbbbb
Ten characters	lpcAbbbbbbbbb b	
Function Key Label		IOcbbbb
Lower Case	Disable Lower Case	Bn0
	Enabled Lower Case	Bn1
Shift Key Programming	Shift Key Normal Mode	Bo0
	Shift Key Function 5	Bo1
Echo	Full Keypad Echo	Bq0
	No Echo Function Key	Bq1
	No Echo on any Key	Bq2
Date		IAddmmyy
Time		IBhhmm
Contrast	lighter	IC0
	darker	IC1
Display-Off Timeout		IFtt
Last Code Shown Timeout		IRtt
Backlight	All Backlighting Disabled	IE0
	Display enabled, Keyboard disabled	IE1
	Display disabled, Keyboard enabled	IE2
	Display disabled, Keyboard disabled	IE3
Screen Refresh	Enabled	Bp0
	Disabled	Bp1
Keyboard Data Format Enable	Disabled	Be0
	Enabled	Be1
Time Stamping Mode	Data from both barcode and keyboard	Bf0
	Data only from barcode	Bf1
	Data only from keyboard	Bf2

DISPLAY PARAMETERS 16-Keys (Continued)		
Keypad Data Header	no header	EV00
	one character	EV01<i>b</i>
	two characters	EV02<i>bb</i>
	three characters	EV03<i>bbb</i>
	four characters	EV04<i>bbbb</i>
	five characters	EV05<i>bbbbb</i>
	six characters	EV06<i>bbbbbb</i>
	seven characters	EV07<i>bbbbbbb</i>
eight characters	EV08<i>bbbbbbbb</i>	
Keypad Data Terminator	no terminator	EV10
	one character	EV11<i>b</i>
	two characters	EV12<i>bb</i>
	three characters	EV13<i>bbb</i>
	four characters	EV14<i>bbbb</i>
	five characters	EV15<i>bbbbb</i>
	six characters	EV16<i>bbbbbb</i>
	seven characters	EV17<i>bbbbbbb</i>
eight characters	EV18<i>bbbbbbbb</i>	
Operative Mode Selection	Simple Data Input Mode	Bd0
	Quantity/Code Mode	Bd1
Enter Key Configuration	Generate error sound	Br0
	Send null char	Br1
QTY Field	Transmit code with default QTY	Bh0
	Transmit code alone	Bh1
	Discard barcode, generate error beep	Bh2
QTY/CODE send mode	QTY precedes CODE	Bg0
	CODE precedes QTY	Bg1
	Code sent out	Bg2
Repeat Timeout		Bift
QTY/CODE separator	no terminator	EW0
	one character	EW1<i>b</i>
	two characters	EW2<i>bb</i>
	three characters	EW3<i>bbb</i>
	four characters	EW4<i>bbbb</i>
	five characters	EW5<i>bbbbb</i>
	six characters	EW6<i>bbbbbb</i>
	seven characters	EW7<i>bbbbbbb</i>
eight characters	EW8<i>bbbbbbbb</i>	
Append Code	Overwrite CODE and transmit	Bm0
	Append to CODE and transmit	Bm1
	Append to code, don't transmit	Bm2

ddmmyy = numbers from the Hex/Numeric Table representing day, month, year
hhmm = numbers from the Hex/Numeric Table representing hour, minutes
a = a number from the Hex/Numeric Table
b = HEX values representing an ASCII character
c = a number from the Hex/Numeric Table in range [1..5] representing the Function Key identifier
x = a number from the Hex/Numeric Table in range [0..A] representing the CMD_ID identifier

t = a number in the range **00-99** (sec.) from the Hex/Numeric Table
00 = Timeout disabled (always on).

b = 3 Hex values from **00** to **FE** representing the left, centre and right keys.
FF = KeyID disabled.

B CODE IDENTIFIER TABLE

2/5 Interleaved



2/5 Industrial



2/5 normal 5 bars



2/5 matrix 3 bars



EAN 8



EAN 13



UPC A



UPC E



EAN 8 with 2 ADD ON



EAN 8 with 5 ADD ON



EAN 13 with 2 ADD ON



EAN 13 with 5 ADD ON



UPC A with 2 ADD ON



UPC A with 5 ADD ON



UPC E with 2 ADD ON



UPC E with 5 ADD ON



Code 39



Code 39 Full ASCII



CODABAR



ABC CODABAR



Code 128



EAN 128



Code 93



CIP/39



CIP/HR



Code 32



ISBT 128



MSI



Code 16K



Code 11



Code 49



GS1 DATABAR Expanded Linear and Stacked



GS1 DATABAR Limited



GS1 DATABAR 14 Linear and Stacked



C HEX AND NUMERIC TABLE

CHARACTER TO HEX CONVERSION TABLE					
char	hex	char	hex	char	hex
NUL	00	*	2A	U	55
SOH	01	+	2B	V	56
STX	02	,	2C	W	57
ETX	03	-	2D	X	58
EOT	04	.	2E	Y	59
ENQ	05	/	2F	Z	5A
ACK	06	0	30	[5B
BEL	07	1	31	\	5C
BS	08	2	32]	5D
HT	09	3	33	^	5E
LF	0A	4	34	~	5F
VT	0B	5	35	␣	60
FF	0C	6	36	a	61
CR	0D	7	37	b	62
SO	0E	8	38	c	63
SI	0F	9	39	d	64
DLE	10	:	3A	e	65
DC1	11	;	3B	f	66
DC2	12	<	3C	g	67
DC3	13	=	3D	h	68
DC4	14	>	3E	i	69
NAK	15	?	3F	j	6A
SYN	16	@	40	k	6B
ETB	17	A	41	l	6C
CAN	18	B	42	m	6D
EM	19	C	43	n	6E
SUB	1A	D	44	o	6F
ESC	1B	E	45	p	70
FS	1C	F	46	q	71
GS	1D	G	47	r	72
RS	1E	H	48	s	73
US	1F	I	49	t	74
SPACE	20	J	4A	u	75
!	21	K	4B	v	76
"	22	L	4C	w	77
#	23	M	4D	x	78
\$	24	N	4E	y	79
%	25	O	4F	z	7A
&	26	P	50	{	7B
'	27	Q	51		7C
(28	R	52	}	7D
)	29	S	53	~	7E
		T	54	DEL	7F

CHARACTER TO HEX CONVERSION TABLE					
char	hex	char	hex	char	hex
€	80	ª	AA	Õ	D5
□	81	«	AB	Ö	D6
,	82	¬	AC	×	D7
ENTER	83	-	AD	Ø	D8
TAB	84	®	AE	Ù	D9
F1	85	—	AF	Ú	DA
F2	86	°	B0	Û	DB
F3	87	±	B1	Ü	DC
F4	88	²	B2	Ý	DD
F5	89	³	B3	Þ	DE
F6	8A	´	B4	ß	DF
F7	8B	µ	B5	à	E0
F8	8C	¶	B6	á	E1
F9	8D	·	B7	â	E2
F10	8E	¸	B8	ã	E3
F11	8F	¹	B9	ä	E4
F12	90	º	BA	å	E5
HOME	91	»	BB	æ	E6
END	92	¼	BC	ç	E7
Pg UP	93	½	BD	è	E8
Pg Down	94	¾	BE	é	E9
↑	95	¿	BF	ê	EA
↓	96	À	C0	ë	EB
←	97	Á	C1	ì	EC
→	98	Â	C2	í	ED
ESC	99	Ã	C3	î	EE
CTRL(Right)	9A	Ä	C4	ï	EF
€	9B	Å	C5	ð	F0
œ	9C	Æ	C6	ñ	F1
□	9D	Ç	C7	ò	F2
ž	9E	È	C8	ó	F3
ÿ	9F	É	C9	ô	F4
NBSP	A0	Ê	CA	õ	F5
ı	A1	Ë	CB	ö	F6
ø	A2	Ì	CC	÷	F7
£	A3	Í	CD	ø	F8
¤	A4	Î	CE	ù	F9
¥	A5	Ï	CF	ú	FA
ı	A6	Ð	D0	û	FB
ı	A7	Ñ	D1	ü	FC
ı	A8	Ò	D2	ý	FD
©	A9	Ó	D3	Reserved	FE
		Ô	D4	Reserved	FF



HEX/NUMERIC KEYPAD



Enter Configuration



HEX/NUMERIC KEYPAD

Exit and Save Configuration



Enter Configuration



HEX/NUMERIC KEYPAD

Exit and Save Configuration



O



Q



S



U



W



Y



N



P



R



T



V



X



Z



HEX/NUMERIC KEYPAD



Enter Configuration



HEX/NUMERIC KEYPAD

Exit and Save Configuration



o



q



s



u



w



y



n



p



r



t



v



x



z

Australia

Datalogic Scanning Pty Ltd
Telephone: [61] (2) 9870 3200
australia.scanning@datalogic.com

France and Benelux

Datalogic Scanning SAS
Telephone: [33].01.64.86.71.00
france.scanning@datalogic.com

Germany

Datalogic Scanning GmbH
Telephone: 49 (0) 61 51/93 58-0
germany.scanning@datalogic.com

India

Datalogic Scanning India
Telephone: 91- 22 - 64504739
india.scanning@datalogic.com

Italy

Datalogic Scanning SpA
Telephone: [39] (0) 39/62903.1
italy.scanning@datalogic.com

Japan

Datalogic Scanning KK
Telephone: 81 (0)3 3491 6761
japan.scanning@datalogic.com

Latin America

Datalogic Scanning, Inc
Telephone: (305) 742-2206
latinamerica.scanning@datalogic.com

Singapore

Datalogic Scanning Singapore PTE LTD
Telephone: (65) 6435-1311
singapore.scanning@datalogic.com

Iberia

Datalogic Scanning SAS Sucursal en España
Telephone: 34 91 746 28 60
spain.scanning@datalogic.com

United Kingdom

Datalogic Scanning LTD
Telephone: 44 (0) 1582 791700
uk.scanning@datalogic.com



www.scanning.datalogic.com

Datalogic Scanning, Inc.

959 Terry Street
Eugene, OR 97402
USA
Telephone: (541) 683-5700

