

 **DATALOGIC**

**BC9xx0-BT**  
**Base Station/Charger**



**Quick Reference Guide**

## **Datalogic ADC, Inc.**

959 Terry Street  
Eugene, OR 97402  
USA

Telephone: (541) 683-5700

Fax: (541) 345-7140

©2013 Datalogic, Inc.

An Unpublished Work - All rights reserved. No part of the contents of this documentation or the procedures described therein may be reproduced or transmitted in any form or by any means without prior written permission of Datalogic ADC, Inc. or its subsidiaries or affiliates ("Datalogic" or 'Datalogic ADC"). Owners of Datalogic products are hereby granted a non-exclusive, revocable license to reproduce and transmit this documentation for the purchaser's own internal business purposes. Purchaser shall not remove or alter any proprietary notices, including copyright notices, contained in this documentation and shall ensure that all notices appear on any reproductions of the documentation.

Should future revisions of this manual be published, you can acquire printed versions by contacting your Datalogic representative. Electronic versions may either be downloadable from the Datalogic website ([www.datalogic.com](http://www.datalogic.com)) or provided on appropriate media. If you visit our website and would like to make comments or suggestions about this or other Datalogic publications, please let us know via the "Contact Datalogic" page.

### **DISCLAIMER**

Datalogic has taken reasonable measures to provide information in this manual that is complete and accurate, however, Datalogic reserves the right to change any specification at any time without prior notice.

Datalogic and the Datalogic logo are registered trademarks of Datalogic S.p.A. in many countries, including the U.S.A. and the E.U. All other brand and product names may be trademarks of their respective owners.

### **PATENTS**

This product may be covered by one or more of the following patents:

Design Patents: AU344427; AU344428; AU344429; EP1970237; USD682277; ZL 201230284676.X

Utility Patents: EP996284; EP999514; EP1128315; EP1172756; EP1396811; EP1413971; EP1828957; JP4435343; US5481098; US6478224; US6512218; US6513714; US6561427; US6808114; US6877664; US6997385; US7053954; US7234641; US7387246; US7721966.

Additional patents pending.



## Table of Contents

Installation .....	2
Mounting the BC9xx0-BT Cradle .....	2
Mounting Brackets .....	2
To change the Bracket:.....	3
Permanent Mounting .....	4
Mounting for Portable Use .....	4
Mounting the Metal Plate.....	4
Attaching the Metal Plate to Base.....	5
System Connections .....	6
Connecting and Disconnecting the Interface Cable .....	6
BC9xx0-BT Configuration .....	8
Datalogic Aladdin™ .....	8
Serial Configuration .....	8
Configuration Bar Codes .....	8
Resetting Standard Product Defaults .....	8
Selecting the Interface Type .....	9
Configuring the Interface.....	9
Keyboard Interface .....	11
Scancode Tables.....	12
Country Mode .....	13
Caps Lock State .....	17
Numlock .....	18
Technical Features .....	19
Regulatory Information .....	20
Compliance .....	20
Power Supply .....	20
FCC Compliance .....	20
Radio Compliance .....	20
WEEE Compliance .....	21
Datalogic ADC Limited Factory Warranty .....	22
Ergonomic Recommendations .....	23
Services and Support .....	24
Products.....	24
Service & Support .....	24
Contact Us .....	24

---

## NOTES

## Using the BC9xx0-BT Base Station

The BC9xx0-BT base station, when paired with one or more PowerScan™ BT9500 readers, builds a Cordless Reading System for the collection, decoding and transmission of bar code data. It can be connected to a Host PC via RS-232, USB, or KBD Wedge, and is suited for single-cradle layouts. The BC91x0 models also provide a spare battery charger slot.

The label on the cradle contains LED indicators and a multi-function button. When the button is pressed for less than 5 seconds, the cradle will transmit a "broadcast" message." When the broadcast is sent, all properly configured scanners (Radio RX Timeout set to keep the radio "awake") that are linked to that base and within radio range coverage will emit a beep and blink within 5 seconds. This functionality is useful to:

- verify which scanners are linked to a certain base station
- detect a scanner forgotten somewhere

When the button is pressed for longer than 5 seconds, all paired scanners will be unpaired.

The LEDs signal the BC9xx0-BT status, as shown in the table below:



LED	STATUS
Aux	Yellow On = BC9xx0-BT is powered through an external power supply.
Host	Yellow On = BC9xx0-BT is powered by the Host.
Reader	Green On = the reader battery is completely charged. Red On = the reader battery is charging. Orange Blinking = reader battery fault - replace battery. Red / Green Alternatively Blinking = charging error - see PRG. Off = reader not in the cradle or not properly inserted.
Spare (BC91x0-BT models only)	Green On = the spare battery is completely charged. Orange Blinking = spare battery fault - replace spare battery. Red/Green Alternatively Blinking = charging error - see PRG. Off = no spare battery in the housing or battery not fully inserted.
Radio	Yellow Blinking = radio activity.
Ethernet (Ethernet models only)	Green Blinking = Ethernet activity.

## Installation

To set up your BC9xx0-BT cradle you must:

1. Physically install the cradle.
2. Make all system connections.
3. Configure the BC9xx0-BT cradle.

## Mounting the BC9xx0-BT Cradle

The cradle package contains the following items:

- BC9xx0-BT Base Station (with Desktop Mounting Bracket installed)
- BC9xx0-BT Quick Reference Guide (this manual)
- 1 Metal Mounting plate
- 1 Wall Mounting Bracket

The cradle can be either mounted on a flat surface for desktop usage or affixed vertically to a wall.

## Mounting Brackets

The cradle comes with two different mounting brackets. The appropriate bracket is used depending on whether the cradle will be mounted on a horizontal or vertical surface. When shipped, the cradle has the Desktop Mounting Bracket installed. For vertical installation, the Wall Mounting Bracket must be attached instead.

**Figure 1. Mounting Brackets**

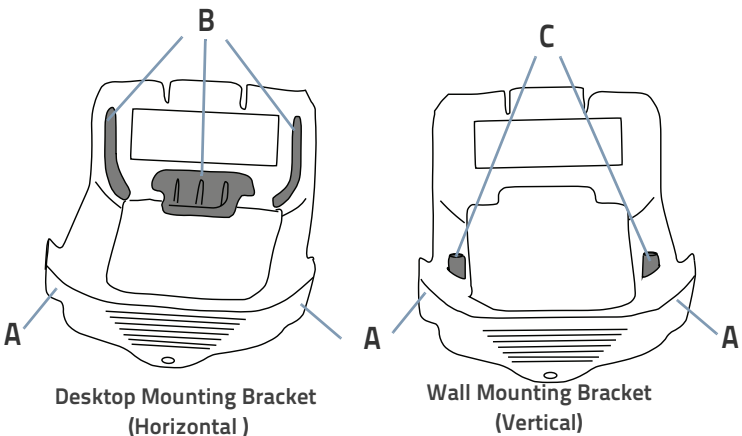

A	Tabs	B	Ribs	C	Bosses
---	------	---	------	---	--------

- Desktop mount bracket has ribs to keep the scanner in place when the cradle is horizontal
- Wall mount bracket contains bosses to keep the scanner in place when the cradle is vertical.

### To change the Bracket:

1. Remove the screw holding the Bracket in place. Retain the screw for re-use.
2. Carefully lift off the Bracket.
3. Install the other bracket by first slipping the end tab into place on the base station, then easing the tabs (shown in [Figure 1 on page 2](#)) into place on the sides.
4. Replace the screw to secure the Bracket to the Base Station.

**Figure 2. Changing the Bracket**



## Permanent Mounting

For either desktop or wall mounting, the cradle can be fastened directly to a flat surface using screws (not included).



**When mounting on drywall, the base should be screwed to a wall stud or supporting beam for additional support.**

Figure 3. Base Station Bottom

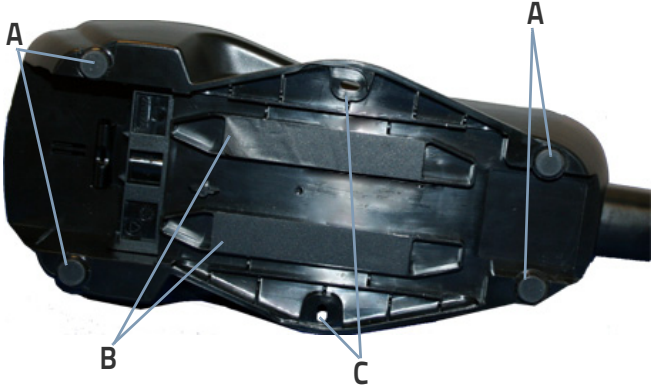

A	Rubber Feet	B	Protective adhesive strips	C	Mounting Holes
---	-------------	---	----------------------------	---	----------------

## Mounting for Portable Use

If portability of the cradle is required, the metal plate must be used. There are two ways this can be done: (1) by first mounting the metal plate on a flat surface so the cradle can be slid off and on, or (2) mounting the metal plate onto the back of the base station and then screwing both to the desired surface.



**For additional security on wall mounting, it is strongly recommended that the cradle be secured into place using two auxiliary screws through the mounting holes on the side.**

## Mounting the Metal Plate

1. Affix the metal plate onto the desired mounting surface using the two center screw holes (see [Figure 4 on page 5](#)).
2. Remove the adhesive strips protecting the mounting tabs on the cradle, shown in [Figure 3](#).
3. Slide the tabs on the back of the cradle onto the metal plate as shown in [Figure 4](#).
4. After aligning the tabs, push up to lock into place.

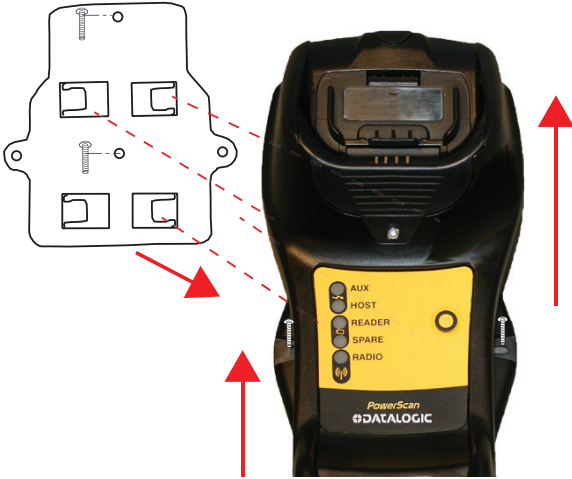

**Figure 4. Mounting Plate on wall**

### Attaching the Metal Plate to Base

Alternatively, the mount can be attached first to the base, then both can be mounted to a wall as described above.

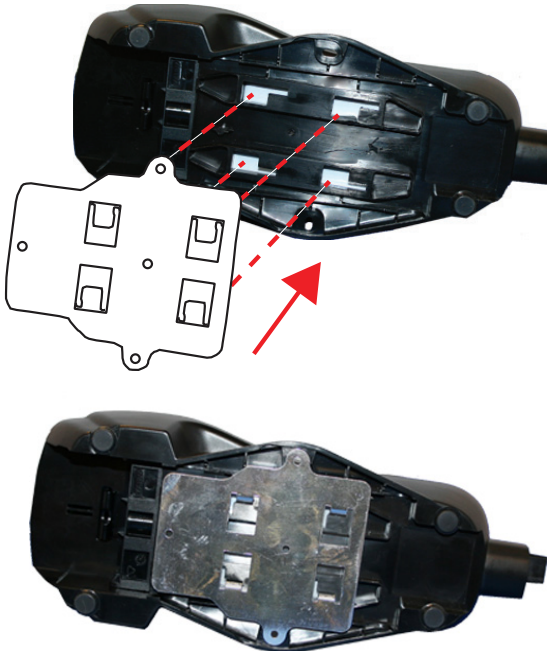
**Figure 5. Attaching Mounting plate to base**

## System Connections



Connections should always be made with power off!

The BC9xx0-BT cradle provides a multi-interface connector and a power supply connector as shown:



Power Supply

Multi-Interface Connector

## Connecting and Disconnecting the Interface Cable

The BC9xx0-BT can be connected to a Host by means of a multi-interface cable, which must be simply plugged into the Host connector, visible on the front panel of the cradle.

To disconnect the cable, insert a paper clip or other similar object into the hole corresponding to the Host connector on the body of the cradle (shown below). Push down on the clip while unplugging the cable. Refer to the following figure:

### Connecting/Disconnecting the Cable

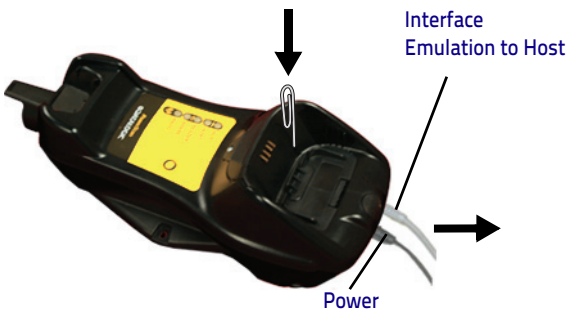

## RS-232

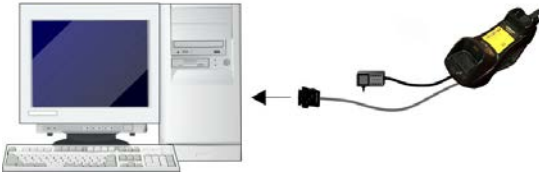

## USB\*



\*The power supply is optional, the cradle can be powered by the USB port. In this case the full charging of an empty battery will take about 10 hours. For intense usage and/or when the system is shut down during the night, the use of an external power supply is recommended.

## WEDGE

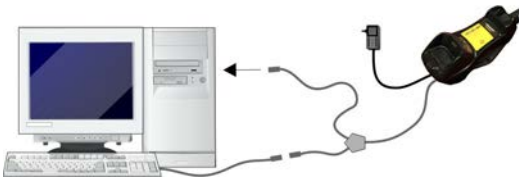

## BC9xx0-BT Configuration

The BC9xx0-BT configuration can be performed in three ways: by using the Datalogic Aladdin™ software configuration program, by sending configuration strings from the Host PC via the RS-232 or USB-COM interface or by reading configuration bar codes with the PowerScan™ BT9500 reader.

### Datalogic Aladdin™

Datalogic Aladdin™ is a multi-platform utility program that provides a quick and user-friendly configuration method via the RS-232/USB-COM interface. It also allows upgrading the software of the connected device (see the Datalogic Aladdin™ Help On-Line for more details).

### Serial Configuration

By connecting the BC9xx0-BT to a PC through an RS-232 or USB-COM interface cable it is possible to send configuration strings from the PC to BC9xx0-BT.

### Configuration Bar Codes

Link the cradle and the reader using the procedures described in the PowerScan™ BT9500 Quick Reference. Once the pairing is complete, you can configure the BC9xx0-BT cradle by reading configuration bar codes in this manual. To configure the BC9xx0-BT using the PowerScan™ BT9500 reader (paired to the cradle with the Bind command), follow the procedure according to the interface selected.

### Resetting Standard Product Defaults

Reference the PRG for a listing of standard factory settings. If you aren't sure what programming options are in your reader, or you've changed some options and want the factory settings restored, scan the **Standard Product Default Settings** bar code below to copy the factory configuration for the currently active interface to the current configuration.



**Factory defaults are based on the interface type. Configure the reader for the correct interface before scanning this label.**



Standard Product Default Settings



**Scanning this bar code will RESET all settings for the PowerScan BT9500. Any customized settings that may have been applied to the reader will be lost.**

To change the defaults refer to the PowerScan™ 9500 PRG, or to the Datalogic Aladdin™ Configuration program, both downloadable from the Datalogic website.

## Selecting the Interface Type

Upon completing the physical connection between the reader and its host, scan the appropriate bar code for your system's correct interface type.



### Configuring the Interface





Scan the programming bar code which selects the appropriate interface type for the system the reader will be connected to.



Unlike some other programming features and options, interface selections require that you scan only one programming bar code label. **DO NOT** scan an ENTER/EXIT bar code prior to scanning an interface selection bar code.

Some interfaces require the scanner to start in the disabled state when powered up. If additional scanner configuration is desired while in this state, pull the trigger and hold for 5 seconds. The scanner will change to a state that allows programming with bar codes.





RS-232
<p>RS-232 standard interface</p>  <p>Select RS232-STD</p>
<p>RS-232 Wincor-Nixdorf</p>  <p>Select RS232-WN</p>
<p>RS-232 for use with OPOS/UPOS/JavaPOS</p>  <p>Select RS-232 OPOS</p>





USB
<p>USB COM to simulate RS-232 standard interface</p>  <p>USB-COM-STD<sup>a</sup></p>
<p>USB-OEM (can be used for OPOS/UPOS/JavaPOS)</p>  <p>USB-OEM</p>
<p>USB Keyboard with standard key encoding</p>  <p>Select USB Keyboard</p>
<p>USB Keyboard with alternate key encoding</p>  <p>USB Alternate Keyboard</p>
<p>USB Keyboard for Apple computers</p>  <p>USB-KBD-APPLE</p>

a. Download the correct USB COM driver from [www.datalogic.com](http://www.datalogic.com)

## Keyboard Interface

Use the programming bar codes to select options for USB Keyboard and Wedge Interfaces.

KEYBOARD
AT, PS/2 25-286, 30-286, 50, 50Z, 60, 70, 80, 90 & 95 w/ Standard Key Encoding  Select KBD-AT
Keyboard Wedge for IBM AT PS2 with standard key encoding but without external keyboard  Select KBD-AT-NK
AT, PS/2 25-286, 30-286, 50, 50Z, 60, 70, 80, 90 & 95 w/Alternate Key  Select KBD-AT-ALT
Keyboard Wedge for IBM AT PS2 with alternate key encoding but without external keyboard  Select KBD-AT-ALT-NK
PC/XT w/Standard Key Encoding  Select KBD-XT

KEYBOARD (continued)
Keyboard Wedge for IBM Terminal 3153  Select KBD-IBM-3153
Keyboard Wedge for IBM Terminals 31xx, 32xx, 34xx, 37xx make only keyboard  Select KBD-IBM-M
Keyboard Wedge for IBM Terminals 31xx, 32xx, 34xx, 37xx make break keyboard  Select KBD-IBM-MB
Keyboard Wedge for DIGITAL Terminals VT2xx, VT3xx, VT4xx  Select KBD-DIG-VT

## Scancode Tables

Reference the PowerScan™ 9500 PRG for information about control character emulation which applies to keyboard interfaces.



## Country Mode







This feature specifies the country/language supported by the keyboard. Only these interfaces support ALL Country Modes:

- USB Keyboard (without alternate key encoding)
- AT, PS/2 25-286, 30-286, 50, 50Z, 60, 70, 80, 90 & 95 w/Std Key Encoding
- Keyboard Wedge for IBM AT PS2 with standard key encoding but without external keyboard
- AT, PS/2 25-286, 30-286, 50, 50Z, 60, 70, 80, 90 & 95 without Alternate Key
- Keyboard Wedge for IBM AT PS2 without alternate key encoding but without external keyboard

All other interfaces support ONLY the following Country Modes: U.S., Belgium, Britain, France, Germany, Italy, Spain, Sweden.

COUNTRY MODE
 ENTER/EXIT PROGRAMMING MODE
 Country Mode = U.S.
 Country Mode = Belgium
 Country Mode = Britain

\*Supports only the interfaces listed in the Country Mode feature description

COUNTRY MODE (continued)
 Country Mode = Croatia*
 Country Mode = Czech Republic*
 Country Mode = Denmark*
 Country Mode = France
 Country Mode = French Canadian
 Country Mode = Germany

\*Supports only the interfaces listed in the Country Mode feature description

COUNTRY MODE (continued)
 Country Mode = Hungary*
 Country Mode = Italy
 Country Mode = Japanese 106-key*
 Country Mode = Lithuanian
 Country Mode = Norway*
 Country Mode = Poland*
 Country Mode = Portugal*

\*Supports only the interfaces listed in the Country Mode feature description

COUNTRY MODE (continued)
 Country Mode = Romania*
 Country Mode = Spain
 Country Mode = Sweden
 Country Mode = Slovakia*
 Country Mode = Switzerland*

\*Supports only the interfaces listed in the Country Mode feature description



## Caps Lock State

This option specifies the format in which the reader sends character data. This applies to keyboard wedge interfaces. This does not apply when an alternate key encoding keyboard is selected.

 ENTER/EXIT PROGRAMMING MODE
 Caps Lock State = Caps Lock OFF
 Caps Lock State = Caps Lock ON
 Caps Lock State = AUTO Caps Lock Enable

## Numlock

This option specifies the setting of the Numbers Lock (Numlock) key while in keyboard wedge interface. This only applies to alternate key encoding interfaces. It does not apply to USB keyboard.

 ENTER/EXIT PROGRAMMING MODE
 Numlock = Numlock key unchanged
 Numlock = Numlock key toggled

## Technical Features

<b>Electrical Features</b>	
Supply Voltage	
External Power	10 - 30 VDC
Host Power	5 VDC ±10%
Power Consumption	
External Power	max. 10 W (charging) *
Host Power	max. 500 mA (charging)
Indicators	Ext. Power/Data yellow LED Host Power/Data yellow LED Reader batt. state green/red LED Spare batt. state green/red LED Radio yellow LED Ethernet green LED (Ethernet models only)
Time of Recharge	
External Power	max. 4 hours with 2150 mAh Li-Ion battery
Host Power	max. 10 hours with 2150 mAh Li-Ion battery
<b>Bluetooth Features</b>	
Protocol	Bluetooth 2.0; Class 1; SPP (Serial Port Profile) or HID (Human Interface Device) profile
Radio Frequency	2.40 to 2.48 GHz
<b>Environmental Features</b>	
Working Temperature	
Radio	-20° to +50 °C / -4 to +122 °F
Battery Charging	0° to +40 °C / +32° to +104 °F
Storage Temperature	-20° to +70 °C / -4 to +158 °F
Humidity	90% non condensing
Protection Class	IP40
<b>Mechanical Features</b>	
Weight without metal plate	about 390 g / 13.76 oz
Dimensions (without antenna)	235 x 108 x 80 mm
<b>System Configuration</b>	
Max number of devices per base station	7

\* Having a switching regulator inside, the BC9xx0-BT draws the same power, regardless of the supply voltage. i.e. as the input voltage increases the current drawn decreases

## Regulatory Information

### Compliance

This device must be opened by qualified personnel only.

### Power Supply

This device is intended to be supplied by a UL Listed/CSA Certified Power Unit marked "Class 2" or LPS power source rated 10-30 V DC, minimum 1 A, which supplies power directly to the cradle.

### FCC Compliance

Modifications or changes to this equipment without the expressed written approval of Datalogic could void the authority to use the equipment.

This device complies with PART 15 of the FCC Rules. Operation is subject to the following two conditions: (1) This device may not cause harmful interference, and (2) this device must accept any interference received, including interference which may cause undesired operation.

This device contains FCC ID:O9NDLBTMCX.

### Radio Compliance

Contact the competent authority responsible for the management of radio frequency devices of your country to verify any possible restrictions or licenses required.

Refer to the web site <http://europa.eu.int/comm/enterprise/rtte/spectr.htm> for further information.





## WEEE Compliance



### Waste Electrical and Electronic Equipment (WEEE) Statement

#### English

For information about the disposal of Waste Electrical and Electronic Equipment (WEEE), please refer to the website at [www.datalogic.com](http://www.datalogic.com).

#### Italian

Per informazioni sullo smaltimento delle apparecchiature elettriche ed elettroniche consultare il sito Web [www.datalogic.com](http://www.datalogic.com).

#### French

Pour toute information relative à l'élimination des déchets électroniques (WEEE), veuillez consulter le site Internet [www.datalogic.com](http://www.datalogic.com).

#### German

Informationen zur Entsorgung von Elektro- und Elektronik- Altgeräten (WEEE) erhalten Sie auf der Webseite [www.datalogic.com](http://www.datalogic.com).

#### Spanish

Si desea información acerca de los procedimientos para el desecho de los residuos del equipo eléctrico y electrónico (WEEE), visite la página Web <http://www.datalogic.com>.

#### Portuguese

Para informações sobre a disposição de Sucatagem de Equipamentos Eléctricos e Eletrônicos (WEEE - Waste Electrical and Electronic Equipment), consultar o site web <http://www.datalogic.com>.

#### Chinese

有关处理废弃电气电子设备 (WEEE) 的信息, 请参考 Datalogic 公司的网站: <http://www.datalogic.com/>。

#### Japanese

廃電気電子機器 (WEEE) の処理についての関連事項は Datalogic のサイト <http://www.datalogic.com/>, をご参照下さい。

# Datalogic ADC Limited Factory Warranty

## Warranty Coverage

Datalogic warrants this product against defects in workmanship and materials, for a period of 3 years from the date of shipment, provided that the product is operated under normal and proper conditions. Datalogic ("Datalogic") hardware products are warranted against defects in material and workmanship under normal and proper use. The liability of Datalogic under this warranty is limited to furnishing the labor and parts necessary to remedy any defect covered by this warranty and restore the product to its normal operating condition. Repair or replacement of product during the warranty does not extend the original warranty term. Products are sold on the basis of specifications applicable at the time of manufacture and Datalogic has no obligation to modify or update products once sold.

If Datalogic determines that a product has defects in material or workmanship, Datalogic shall, at its sole option repair or replace the product without additional charge for parts and labor, or credit or refund the defective products duly returned to Datalogic. To perform repairs, Datalogic may use new or reconditioned parts, components, subassemblies or products that have been tested as meeting applicable specifications for equivalent new material and products. Customer will allow Datalogic to scrap all parts removed from the repaired product. The warranty period shall extend from the date of shipment from Datalogic for the duration published by Datalogic for the product at the time of purchase (Warranty period). Datalogic warrants repaired hardware devices against defects in workmanship and materials on the repaired assembly for a 90 day period starting from the date of shipment of the repaired product from Datalogic or until the expiration of the original warranty period, whichever is longer. Datalogic does not guarantee, and it is not responsible for, the maintenance of, damage to, or loss of configurations, data, and applications on the repaired units and at its sole discretion can return the units in the "factory default" configuration or with any software or firmware update available at the time of the repair (other than the firmware or software installed during the manufacture of the product). Customer accepts responsibility to maintain a back up copy of its software and data.

## Warranty Claims Process

In order to obtain service under the Factory Warranty, Customer must notify Datalogic of the claimed defect before the expiration of the applicable Warranty period and obtain from Datalogic a return authorization number (RMA) for return of the product to a designated Datalogic service center. If Datalogic determines Customer's claim is valid, Datalogic will repair or replace product without additional charge for parts and labor. Customer shall be responsible for packaging and shipping the product to the designated Datalogic service center, with shipping charges prepaid. Datalogic shall pay for the return of the product to Customer if the shipment is to a location within the country in which the Datalogic service center is located. Customer shall be responsible for paying all shipping charges, duties, taxes, and any other charges for products returned to any other locations. Failure to follow the applicable RMA policy, may result in a processing fee. Customer shall be responsible for return shipment expenses for products which Datalogic, at its sole discretion, determines are not defective or eligible for warranty repair.

## Warranty Exclusions

The Datalogic Factory Warranty shall not apply to:

- (i) any product which has been damaged, modified, altered, repaired or upgraded by other than Datalogic service personnel or its authorized representatives;
- (ii) any claimed defect, failure or damage which Datalogic determines was caused by faulty operations, improper use, abuse, misuse, wear and tear, negligence, improper storage or use of parts or accessories not approved or supplied by Datalogic;
- (iii) any claimed defect or damage caused by the use of product with any other instrument, equipment or apparatus;
- (iv) any claimed defect or damage caused by the failure to provide proper maintenance, including but not limited to cleaning the upper window in accordance with product manual;
- (v) any defect or damage caused by natural or man-made disaster such as but not limited to fire, water damage, floods, other natural disasters, vandalism or abusive events that would cause internal and external component damage or destruction of the whole unit, consumable items;

- (vi) any damage or malfunctioning caused by non-restoring action as for example firmware or software upgrades, software or hardware reconfigurations etc.;
- (vii) the replacement of upper window/cartridge due to scratching, stains or other degradation and/or
- (viii) any consumable or equivalent (e.g., cables, power supply, batteries, keypads, touch screen, triggers etc.).

## No Assignment

Customer may not assign or otherwise transfer its rights or obligations under this warranty except to a purchaser or transferee of product. No attempted assignment or transfer in violation of this provision shall be valid or binding upon Datalogic.

DATALOGIC'S LIMITED WARRANTY IS IN LIEU OF ALL OTHER WARRANTIES, EXPRESS OR IMPLIED, ORAL OR WRITTEN, STATUTORY OR OTHERWISE, INCLUDING, WITHOUT LIMITATION, ANY IMPLIED WARRANTIES OF MERCHANTABILITY, FITNESS FOR A PARTICULAR PURPOSE, OR NONINFRINGEMENT. DATALOGIC SHALL NOT BE LIABLE FOR ANY DAMAGES SUSTAINED BY CUSTOMER ARISING FROM DELAYS IN THE REPLACEMENT OR REPAIR OF PRODUCTS UNDER THE ABOVE. THE REMEDY SET FORTH IN THIS WARRANTY STATEMENT IS THE CUSTOMER'S SOLE AND EXCLUSIVE REMEDY FOR WARRANTY CLAIMS. UNDER NO CIRCUMSTANCES WILL DATALOGIC BE LIABLE TO CUSTOMER OR ANY THIRD PARTY FOR ANY LOST PROFITS, OR ANY INCIDENTAL, CONSEQUENTIAL IN-DIRECT, SPECIAL OR CONTINGENT DAMAGES REGARDLESS OF WHETHER DATALOGIC HAD ADVANCE NOTICE OF THE POSSIBILITY OF SUCH DAMAGES.

## Risk of Loss

Customer shall bear risk of loss or damage for product in transit to Datalogic. Datalogic shall assume risk of loss or damage for product in Datalogic's possession. In the absence of specific written instructions for the return of product to Customer, Datalogic will select the carrier, but Datalogic shall not thereby assume any liability in connection with the return shipment.

# Ergonomic Recommendations



## CAUTION

**In order to avoid or minimize the potential risk of ergonomic injury follow the recommendations below. Consult with your local Health & Safety Manager to ensure that you are adhering to your company's safety programs to prevent employee injury.**

- Reduce or eliminate repetitive motion
- Maintain a natural position
- Reduce or eliminate excessive force
- Keep objects that are used frequently within easy reach
- Perform tasks at correct heights
- Reduce or eliminate vibration
- Reduce or eliminate direct pressure
- Provide adjustable workstations
- Provide adequate clearance
- Provide a suitable working environment
- Improve work procedures

## Services and Support

Datalogic provides several services as well as technical support through its website. Log on to [www.datalogic.com](http://www.datalogic.com) and click on the links indicated for further information.

### Products

Search through the links to arrive at your product page where you can download specific **Manuals** and **Software & Utilities**, including:

- **Datalogic Aladdin™**, a multi-platform utility program that allows device configuration using a PC. It provides RS-232 and USB-COM interface configuration, printing of configuration bar codes, and firmware upgrades.

### Service & Support

- **Technical Support** - Product documentation and programming guides and Technical Support Department in the world
- **Service Programs** - Warranty Extensions and Maintenance Agreements
- **Repair Services** - Flat Rate Repairs and Return Material Authorization (RMA) Repairs
- **Downloads** - Manuals & Documentation, Data Sheets, Product Catalogues, etc.

### Contact Us

- Information Request Form and Sales & Service Network

# NOTES

# NOTES

## DECLARATION OF CONFORMITY



Datalogic ADC Srl, Via S. Vitalino, 13  
Lippo di Calderara di Reno (BO) 40012 Italy

EC-100  
Rev.: 1  
Pag.: 1 di 1

*La presente dichiarazione di conformità è rilasciata sotto la responsabilità esclusiva di Datalogic ADC Srl per:*

*This Declaration of Conformity is issued under the sole responsibility of Datalogic ADC Srl for:*

*Cette déclaration de conformité est établie sous la seule responsabilité de Datalogic Srl pour:*

*Diese Konformitätserklärung wird unter der alleinigen Verantwortung des Datalogic ADC Srl erteilt für:*

*Esta declaración de conformidad se expide bajo la exclusiva responsabilidad de Datalogic ADC Srl para:*

**PowerScan PBT9500 ; Cordless Barcode Reader  
BC9XY0-BT ; Cordless Base Station/Charger**

*e tutti i suoi modelli  
and all its models  
et tous ses modèles  
und seine Modelle  
y todos sus modelos*

*sono conformi alle Direttive del Consiglio Europeo sottoelencate:*

*are in conformity with the requirements of the European Council Directives listed below:*

*sont conformes aux spécifications des Directives de l'Union Européenne ci-dessous:*

*den nachstehenden angeführten Direktiven des Europäischen Rats:*

*cumple con los requisitos de las Directivas del Consejo Europeo, según la lista siguiente:*

**1999/5/EC - R&TTE Directive  
2011/65/EU - RoHS Directive**

*Questa dichiarazione è basata sulla conformità dei prodotti alle norme seguenti:*

*This declaration is based upon compliance of the products to the following standards:*

*Cette déclaration repose sur la conformité des produits aux normes suivantes:*

*Diese Erklärung basiert darauf, daß das Produkt den folgenden Normen entspricht:*

*Esta declaración se basa en el cumplimiento de los productos con las siguientes normas:*

**ETSI EN 301 489-17 v2.1.1, MAY 2009 :** ELECTROMAGNETIC COMPATIBILITY AND RADIO SPECTRUM MATTERS (ERM);  
ELECTROMAGNETIC COMPATIBILITY (EMC) STANDARD FOR RADIO EQUIPMENT;  
PART 17: SPECIFIC CONDITIONS FOR BROADBAND DATA TRANSMISSION SYSTEMS

**ETSI EN 300 328-3 V1.7.1, OCTOBER 2006:** ELECTROMAGNETIC COMPATIBILITY AND RADIO SPECTRUM MATTERS (ERM);  
WIDEBAND TRANSMISSION SYSTEMS; DATA  
TRANSMISSION EQUIPMENT OPERATING IN THE 2,4 GHz ISM BAND AND  
USING WIDE BAND MODULATION TECHNIQUES; HARMONIZED EN COVERING  
ESSENTIAL REQUIREMENTS UNDER ARTICLE 3.2 OF THE R&TTE DIRECTIVE

**EN 60950-1, DECEMBER 2006 + AMENDMENT A11:2009 +** INFORMATION TECHNOLOGY EQUIPMENT - SAFETY -  
PART 1 : GENERAL REQUIREMENTS

**AMENDMENT A1:2010 +  
AMENDMENT A12:2011 :**

**EN 50581, SEPTEMBER 2012 :** TECHNICAL DOCUMENTATION FOR THE ASSESSMENT OF ELECTRICAL AND  
ELECTRONIC PRODUCTS WITH RESPECT TO THE RESTRICTION OF HAZARDOUS  
SUBSTANCES



[www.datalogic.com](http://www.datalogic.com)

©2013 Datalogic, Inc. ■ All rights reserved.  
Datalogic and the Datalogic logo are registered  
trademarks of Datalogic S.p.A. in many countries,  
including the U.S.A. and the E.U.

**Datalogic ADC, Inc.**

959 Terry Street | Eugene | OR 97402 | USA  
Telephone: (1) 541-683-5700 | Fax: (1) 541-345-7140

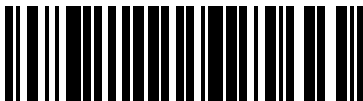

820053014

(Rev A)

Sept 2013