

TC25

Rugged Smartphone

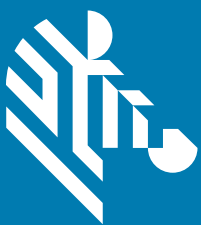

User Guide for Android™ Version 7.1.2



ZEBRA

Copyright

© 2017 ZIH Corp. and/or its affiliates. All rights reserved. ZEBRA and the stylized Zebra head are trademarks of ZIH Corp., registered in many jurisdictions worldwide. Google, Google Play and other marks are trademarks of Google Inc. All other trademarks are the property of their respective owners.

COPYRIGHTS & TRADEMARKS: For complete copyright and trademark information, go to www.zebra.com/copyright.

WARRANTY: For complete warranty information, go to www.zebra.com/warranty.

END USER LICENSE AGREEMENT: For complete EULA information, go to www.zebra.com/eula.

Terms of Use

- Proprietary Statement

This manual contains proprietary information of Zebra Technologies Corporation and its subsidiaries (“Zebra Technologies”). It is intended solely for the information and use of parties operating and maintaining the equipment described herein. Such proprietary information may not be used, reproduced, or disclosed to any other parties for any other purpose without the express, written permission of Zebra Technologies.

- Product Improvements

Continuous improvement of products is a policy of Zebra Technologies. All specifications and designs are subject to change without notice.

- Liability Disclaimer

Zebra Technologies takes steps to ensure that its published Engineering specifications and manuals are correct; however, errors do occur. Zebra Technologies reserves the right to correct any such errors and disclaims liability resulting therefrom.

- Limitation of Liability

In no event shall Zebra Technologies or anyone else involved in the creation, production, or delivery of the accompanying product (including hardware and software) be liable for any damages whatsoever (including, without limitation, consequential damages including loss of business profits, business interruption, or loss of business information) arising out of the use of, the results of use of, or inability to use such product, even if Zebra Technologies has been advised of the possibility of such damages. Some jurisdictions do not allow the exclusion or limitation of incidental or consequential damages, so the above limitation or exclusion may not apply to you.

Revision History

Changes to the original guide are listed below:

Change	Date	Description
-01 Rev A	9/2017	Initial Release
-02 Rev A	1/2018	Add note about SIM card thickness (page 17). Add note that Indonesian configurations do not support LTE.



Table of Contents

Copyright	2
Terms of Use	2
Revision History	2

Table of Contents.....	4
-------------------------------	----------

About This Guide

Configurations	10
Chapter Descriptions	10
Notational Conventions	11
Related Documents and Software	11
Service Information	11
Provide Documentation Feedback	12

Getting Started

Unpacking	13
Features	14
Setup	16
Installing a microSD Card	16
Installing the SIM Card	18
Charging the Battery	19
Charging Indicators	21
Google Account Setup	22
Replacing the microSD Card	22
Replacing the SIM Card	24
Accessing Device Settings	26
Battery Management	26
Monitor Battery Usage	26
Low Battery Notification	27
Battery Optimization	27
Turning Off the Radios	28
Setting the Date and Time	28
Display Setting	28
Setting the Screen Brightness	28
Setting Screen Rotation	29

Table of Contents

Setting Screen Timeout Setting	29
Setting Font Size	29
General Sound Setting	30
Wake-Up Sources	32
Using the TC25	
Google Mobile Services	33
Home Screen	33
Setting Home Screen Rotation	34
Status Bar	35
Status Icons	35
Notification Icons	37
Managing Notifications	37
Setting Application Notifications	38
Viewing Notification Settings for All Apps	38
Controlling Lock Screen Notifications	38
Quick Settings	39
Edit Icons on Quick Settings	40
Application Shortcuts and Widgets	40
Adding an Application to the Home Screen	40
Adding a Widget to the Home Screen	40
Moving Items on the Home Screen	41
Removing an Application Shortcut or Widget from the Home Screen	41
Folders	41
Creating a Folder	41
Naming Folders	41
Removing a Folder	41
Home Screen Wallpaper	42
Using the Touchscreen	42
On-Screen Keyboards	42
Editing Text	42
Entering Numbers, Symbols and Special Characters	43
Switching Language Keyboards	43
Configuring the Keyboard	43
GMS Keyboard	43
Do Not Disturb Feature	44
Limit Sounds and Vibrations	44
Alarms Only	44
Priority Notifications Only	45
Automatically Block Sounds and Vibrations	45
Silence Sounds During Certain Times	45
Silence Sounds During Events and Meetings	46
Turn Sounds Back On	46
Override Do Not Disturb for Specific Apps	46
Applications	47
Accessing Applications	49
Switching Between Recent Applications	50
Un-Locking the Screen	50
Scheduled Power On and Off	51
Resetting the Device	53

Table of Contents

Performing a Soft Reset	53
Performing a Hard Reset	53
Suspend Mode	53
Transferring Files with a Host Computer via USB	54
Transferring Files using Media Transfer Protocol	54
Transferring Files using Photo Transfer Protocol	54
Disconnect from the Host Computer	55
Calls	
Emergency Calling	56
Audio Modes	56
Using a Bluetooth Headset	56
Adjusting Audio Volume	56
Making a Call Using the Dialer	57
Dialer Dialing Options	59
Making a Call Using Contacts	59
Using the Dialer	59
Using the Contacts Application	60
Making a Call Using Call History	60
Making a Conference Call	61
Making a Call Using a Bluetooth Headset	63
Answering Calls	63
Call Settings	64
Display Options	64
Sounds and Vibrations	64
Quick Responses	65
Speed Dial Settings	65
Calls	65
Call Blocking	65
Accessibility	66
Applications	
File Browser	67
Messaging	69
Sending a Text Message	69
Sending a Multimedia Message	69
Contacts	71
Adding a Contact	71
Editing Contacts	71
Deleting Contacts	71
Camera	73
Taking Photos	73
Taking a Panoramic Photo	74
Recording Videos	74
Photo Settings	75
Video Settings	76
Photos	78
Working with Albums	79
Deleting an Album	79

Table of Contents

Working with Photos	80
Viewing and Browsing Photos	80
Cropping a Photo	80
Setting a Photo as a Contact Icon	81
Share a Photo	81
Deleting a Photo	81
Working with Videos	82
Watching Videos	82
Sharing a Video	82
Deleting a Video	82
DataWedge Demonstration	83
Sound Recorder	85
PTT Express Voice Client	86
PTT Audible Indicators	86
Notification Icons	87
Enabling PTT Communication	87
Selecting a Talk Group	88
PTT Communication	88
Creating a Group Call	88
Responding with a Private Response	88
Disabling PTT Express Voice Client Communication	88
RxLogger	90
Enabling Logging	90
Disabling Logging	90
RxLogger Utility	91
Diagnostic Tool	92
Settings	94
Battery Test Information	94
GPS Test Information	94
System Test Information	95
WLAN Test Information	95
WWAN Test Information	95
Bluetooth Test Information	95
Data Capture	
Imaging	96
Operational Modes	96
RS507 Hands-Free Imager	97
RS6000 Bluetooth Ring Scanner	97
Scanning Considerations	97
Barcode Scanning with Internal SE2100 Imager	98
Barcode Scanning with Internal SE4710 Imager	99
Barcode Capture with RS6000 Bluetooth Ring Scanner	100
Barcode Capture with RS507 Hands-Free Imager	101
Pairing the Bluetooth Imager	103
Pairing Using Simple Serial Interface	103
Pairing Using Bluetooth Human Interface Device	103
DataWedge	104
Enabling DataWedge	104
Disabling DataWedge	104

Wireless

Wireless Wide Area Networks 105

 Sharing the Mobile Data Connection 105

 USB Tethering 105

 Bluetooth Tethering 106

 Portable Wi-Fi Hotspot 106

Cellular Network Settings 107

 Disabling Data When Roaming 107

 Enhanced 4G LTE Mode 107

 Search for MicroCell 108

 Editing the Access Point Name 108

Locking the SIM Card 108

Data Usage 109

 Set Data Usage Warning 110

 Set Data Limit 110

Wireless Local Area Networks 110

 Scan and Connect to a Wi-Fi Network 111

 Remove a Wi-Fi Network 112

Bluetooth 112

 Adaptive Frequency Hopping 113

 Security 113

 Bluetooth Profiles 113

 Bluetooth Power States 114

 Bluetooth Radio Power 114

 Enabling Bluetooth 115

 Disabling Bluetooth 115

 Discovering Bluetooth Device(s) 115

 Changing the Bluetooth Name 115

 Connecting to a Bluetooth Device 116

 Selecting Profiles on the Bluetooth Device 116

 Unpairing a Bluetooth Device 116

Accessories

Accessories 117

1-Slot Base Charge Only Cradle 120

 Charging the Device 120

 Battery Charging 121

 Charging Temperature 121

1-Slot Ethernet Charge Cradle 122

 USB/Ethernet Communication 122

 Ethernet LED Indicators 123

 Establishing Ethernet Connection 124

 Charging the Device 124

 Battery Charging 124

 Charging Temperature 125

5-Slot Charge Only Cradle 126

 Charging the TC25 126

 Battery Charging 127

 Charging Temperature 127

Extended Power Pack 128

Table of Contents

Installation	128
Charging	128
Power Pack Charging	130
Charging Temperature	131
Check Power Level	131
Resetting the Extended Power Pack	132
Trigger Handle	133
Installing the Optional Lanyard	133
Inserting the Device into the Trigger Handle	134
Removing the Device from the Trigger Handle	135
Wrist/Arm Mount	137
Wrist/Arm Mount Installation	137
Device Installation	138
Device Removal	140
Scanning	140
Strap Installation	141
Hand Strap	143
Soft Holster	146
Adjusting the Holster	146
Maintenance and Troubleshooting	
Maintaining the TC25	149
Display Best Practices	150
Image Retention	150
Battery Safety Guidelines	150
Cleaning Instructions	151
Approved Cleanser Active Ingredients	151
Harmful Ingredients	151
Cleaning Instructions	151
Special Cleaning Notes	151
Cleaning Materials Required	151
Cleaning Frequency	152
Cleaning the TC25	152
Housing	152
Display	152
Camera and Exit Window	152
Connector Cleaning	152
Cleaning Cradle Connectors	152
Troubleshooting	154
TC25	154
Technical Specifications	
TC25	157

Index

About This Guide

This guide provides information about using the TC25 rugged smartphone and accessories.

✓ **NOTE** Screens and windows pictured in this guide are samples and can differ from actual screens.

This guide applies to model numbers: TC25AJ, TC25BJ, and TC25CJ.

Configurations

This guide covers the following configurations:

Table 1 Configurations

Configuration	Radios	Operating System Android 7.1	Memory RAM/Flash	Data Capture	8 MP Camera	Access Door
TC25AJ-10B101xx	WAN/LAN/PAN	GMS	2 GB/16 GB	SE2100	Yes	Blank
TC25AJ-10C102xx	WAN/LAN/PAN	GMS	2 GB/16 GB	SE4710	No	2-Pin
TC25BJ-10B101xx	WAN/LAN/PAN	GMS	2 GB/16 GB	SE2100	Yes	Blank
TC25BJ-10C102xx	WAN/LAN/PAN	GMS	2 GB/16 GB	SE4710	No	2-Pin

NOTE: Indonesia configurations do not support LTE.

Chapter Descriptions

Topics covered in this guide are as follows:

- [Getting Started](#) provides information on getting the TC25 up and running for the first time.
- [Using the TC25](#) provides information for operating the TC25.
- [Calls](#) provides instructions for making phone calls.

- [Applications](#) provides information on using applications installed on the TC25.
- [Data Capture](#) provides information on capture barcode data.
- [Wireless](#) provides information on the various wireless options.
- [Accessories](#) provides information on using the accessories for the TC25.
- [Maintenance and Troubleshooting](#) includes instructions on cleaning and provides troubleshooting solutions for potential problems during TC25 operation.
- [Technical Specifications](#) provides the technical specifications for the TC25.

Notational Conventions

The following conventions are used in this document:

- **Bold** text is used to highlight the following:
 - Dialog box, window and screen names
 - Drop-down list and list box names
 - Check box and radio button names
 - Icons on a screen
 - Key names on a keypad
 - Button names on a screen.
- Bullets (•) indicate:
 - Action items
 - Lists of alternatives
 - Lists of required steps that are not necessarily sequential.
- Sequential lists (e.g., those that describe step-by-step procedures) appear as numbered lists.

Related Documents and Software

The following documents provide more information about the TC25 rugged smartphone.

- TC25 Quick Reference Guide, p/n MN-003052-xx
- TC25 Regulatory Guide, p/n MN-003053-xx
- TC25 Rugged Smartphone Integrator Guide, p/n MN-003055-xx

For the latest version of this guide and all guides, go to: zebra.com/support.

Service Information

If you have a problem with your equipment, please use the Self-Help support resources available at www.zebra.com. If the support provided via the Self-Help resources is not sufficient, you may contact Zebra Global Customer Support for your region. Contact information is available at: zebra.com/support.

When contacting support, please have the following information available:

- Serial number of the unit

- Model number or product name
- Software type and version number.

Zebra responds to calls by email, telephone or fax within the time limits set forth in support agreements.

If your problem cannot be solved by Zebra Customer Support, you may need to return your equipment for servicing and will be given specific directions. Zebra is not responsible for any damages incurred during shipment if the approved shipping container is not used. Shipping the units improperly can possibly void the warranty.

If you purchased your Zebra business product from a Zebra business partner, contact that business partner for support.

Provide Documentation Feedback

If you have comments, questions, or suggestions about this guide, send an email to EVM-Techdocs@zebra.com.

Getting Started

This chapter provides information for getting the device up and running for the first time.

Unpacking

Carefully remove all protective material from the TC25 and save the shipping container for later storage and shipping.

1. Verify that the following were received:
 - TC25 rugged smartphone
 - Regulatory Guide.
2. Inspect the equipment for damage. If any equipment is missing or damaged, contact the Global Customer Support center immediately.
3. Prior to using the TC25 for the first time, remove the protective shipping film that covers the scan window, display and camera window.

Features

Figure 1 TC25 Front View

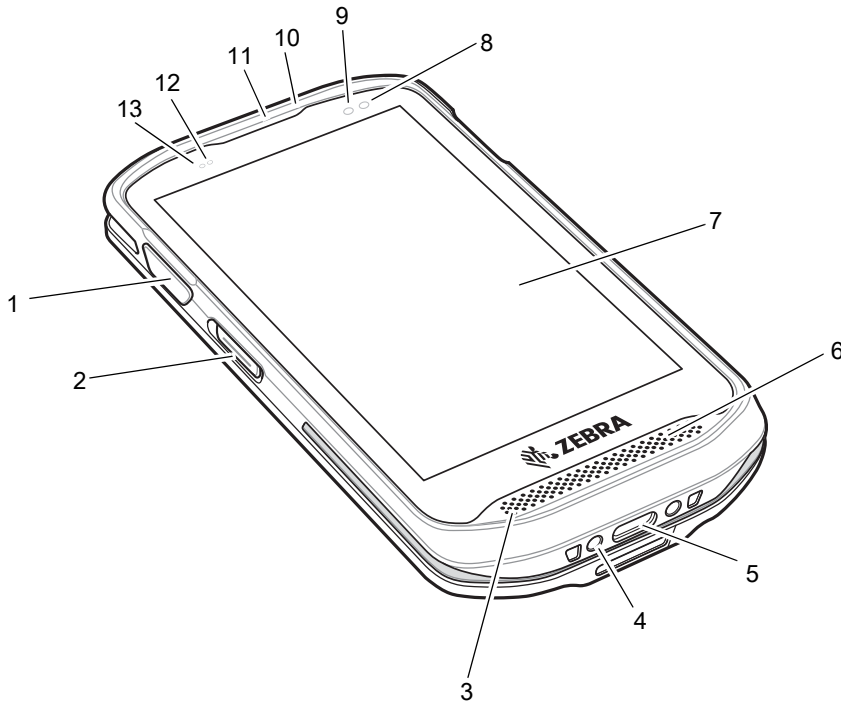

Table 2 Front View Features

Number	Item	Function
1	Scan Button	Initiates data capture (programmable). Yellow button: TC25 with SE4710 imager. Gray button: TC25 with SE2100 imager.
2	PTT Button	Initiates push-to-talk communications (programmable).
3	Microphone	Use for communications in Handset mode.
4	Power Contacts	Provides power for charging the TC25.
5	USB-C Connector	Provides USB host and client communications, and device charging via cables and accessories.
6	Speaker	Provides audio output for video and music playback. Provides audio in speakerphone mode.
7	Touch Screen	Displays all information needed to operate the TC25.
8	Charging/Notification LED	Indicates battery charging status while charging and application generated notifications.
9	Data Capture LED	Indicates data capture status.
10	Microphone	Use for communications in Speakerphone mode.
11	Receiver	Use for audio playback in Handset mode.

Table 2 Front View Features (Continued)

Number	Item	Function
12	Light Sensor	Determines ambient light for controlling display backlight intensity.
13	Proximity Sensor	Determines proximity for turning off display when in handset mode.

Figure 2 TC25 Rear View

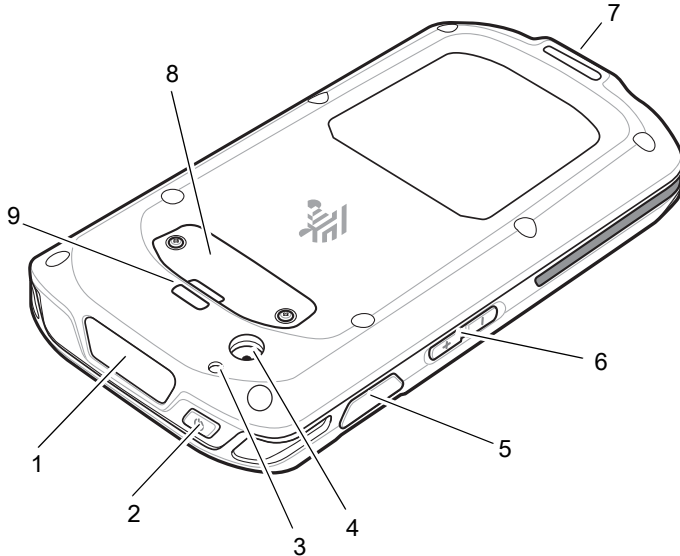

Table 3 Back View Features

Number	Item	Function
1	Imager Window	Provides data capture using the imager.
2	Power Button	Turns the display on and off. Press and hold to reset the device or power off the device.
3	Camera Flash	Provides illumination for the camera.
4	Camera	Takes photos and videos.
5	Scan Button	Initiates data capture.
6	Volume Up/Down Button	Increase and decrease audio volume.
7	Hand Strap Mount Point	Provides latching point for the hand strap.
8	Access Door	Provides access to microSD card slot and SIM card slot. Optional 2-Pin Access Door is available on device with the SE4710 imager for use with the Trigger Handle.
9	Hand Strap Mount Point	Provides latching point for the hand strap.

Setup

Perform this procedure to start using the TC2X for the first time.

1. Install a micro secure digital (SD) card (optional).
2. Installing a nano SIM card
3. Charge the TC25.
4. Power on the TC25.

Installing a microSD Card

The microSD card slot provides secondary non-volatile storage. The slot is located under the access door. Refer to the documentation provided with the card for more information, and follow the manufacturer's recommendations for use.



CAUTION Use proper electrostatic discharge (ESD) precautions to avoid damaging the microSD card. Proper ESD precautions include, but are not limited to, working on an ESD mat and ensuring that the operator is properly grounded.

1. Using a 0# Phillips screwdriver, remove two screws securing the access door.

Figure 3 Remove Access Door

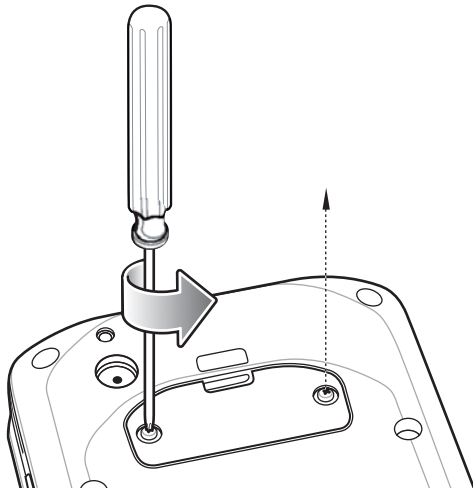

2. Remove access door.

Figure 4 Remove Access Door

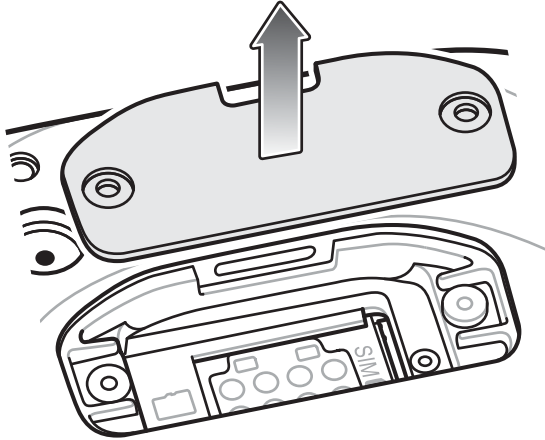

3. Align the microSD card with the SD card slot.

Figure 5 Align microSD Card

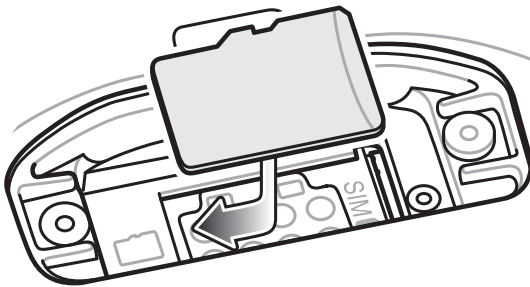

4. Push the microSD card into the SD card slot.

Figure 6 Push microSD Card into the SD Card Slot

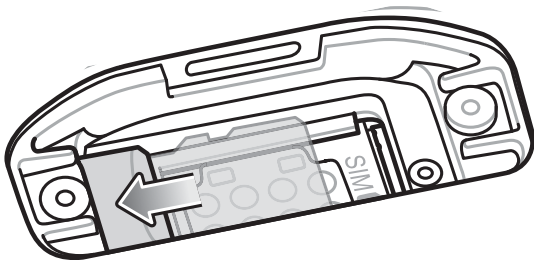

5. Replace the access Door.
6. Secure the access door using the two screws.

Figure 7 Secure Access Door

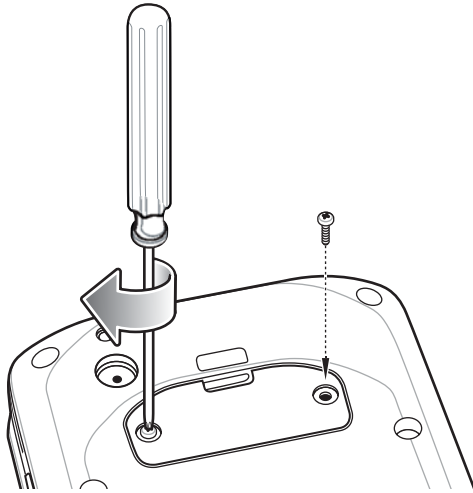

Installing the SIM Card



NOTE Only use a nano SIM card.

Only use nano SIM cards that meet the ETSI TS102.221 standard for nano SIM cards, form factor 4FF (0.67 mm thick). Do not use SIM cards that are cut from thicker mini or micro SIM cards.



CAUTION Use proper electrostatic discharge (ESD) precautions to avoid damaging the SIM card. Proper ESD precautions include, but not limited to, working on an ESD mat and ensuring that the user is properly grounded.

1. Using a 0# Phillips screwdriver, remove two screws securing the access door.

Figure 8 Remove Access Door

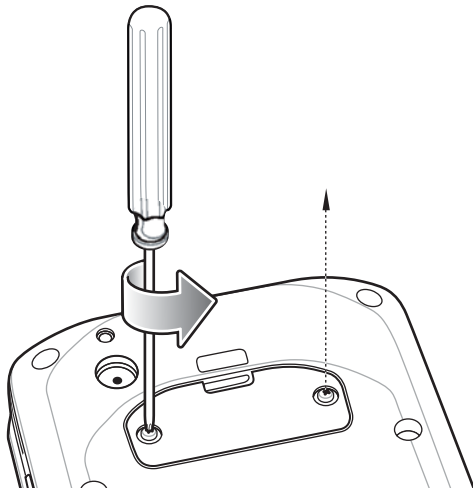

2. Align the SIM card with the SIM card slot with the contacts facing down and the cut edge toward the top of the device.

Figure 9 Align SIM Card with Slot

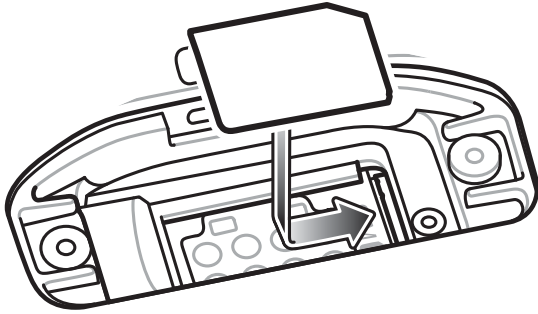

3. Push the SIM card in until it locks into the slot.

Figure 10 Push SIM Card into Slot

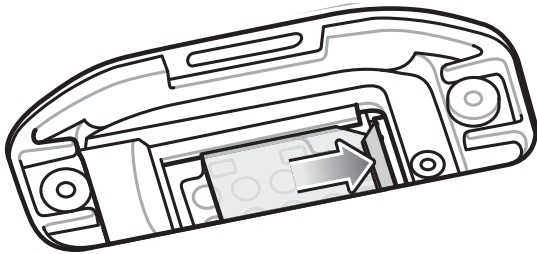

4. Re-install the access door.

Figure 11 Replace Access Door

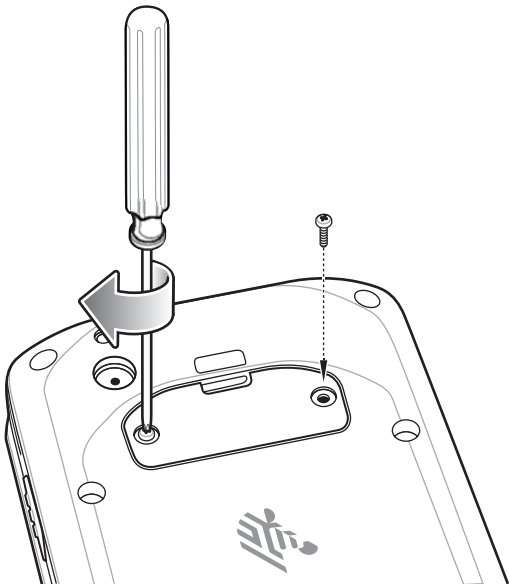

Charging the Battery

Before using the TC25 for the first time, charge the internal battery until the green Charging/Notification light emitting diode (LED) remains lit. To charge the TC25 use a USB-C cable or a cradle with the appropriate power supply. For information about the accessories available for the TC25 see [Accessories](#) for more information.

The internal battery charges from fully depleted to 90% in approximately four hours and from fully depleted to 100% in approximately five hours.



NOTE In many cases the 90% charge provides plenty of charge for daily use. A full 100% charge lasts for approximately 10 hours of use.

Use only Zebra charging accessories and batteries. Charge batteries at room temperature with the TC25 in sleep mode.

Charge batteries in temperatures from 0°C to 40°C (32°F to 104°F). The TC25 or accessory always performs battery charging in a safe and intelligent manner. At higher temperatures (e.g. approximately +37°C (+98°F)) the TC25 or accessory may for small periods of time alternately enable and disable battery charging to keep the battery at acceptable temperatures. The TC25 or accessory indicates when charging is disabled due to abnormal temperatures via its LED and a notification appears on the display.

To charge the main battery:

1. Connect the charging accessory to the appropriate power source.
2. Insert the TC25 into a cradle or attach to a cable. The TC25 turns on and begins charging. The Charging/Notification LED blinks amber while charging, then turns solid green when fully charged.

Figure 12 Charging with Cradle

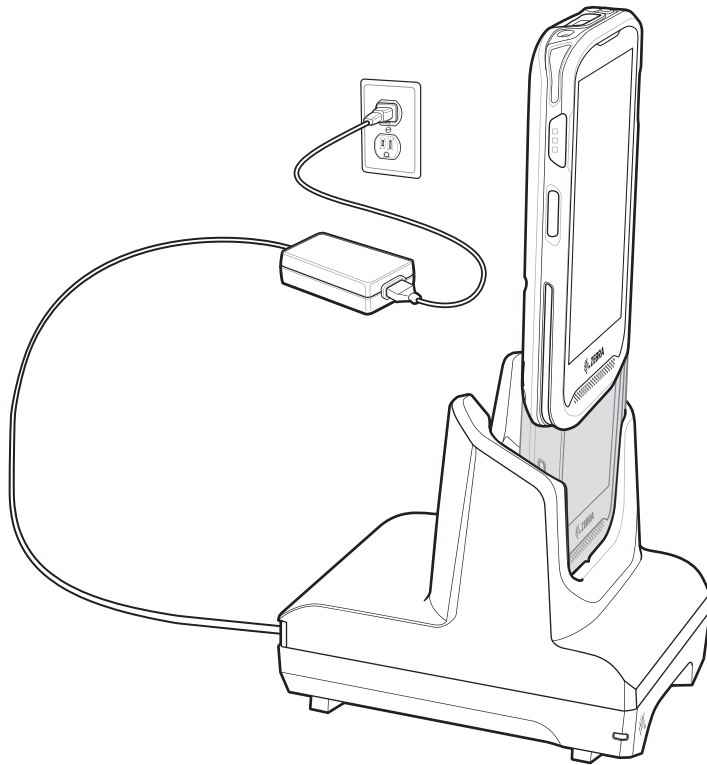

IMPORTANT Use only the Zebra USB-C Cable for charging.

Figure 13 Charging with USB Cable

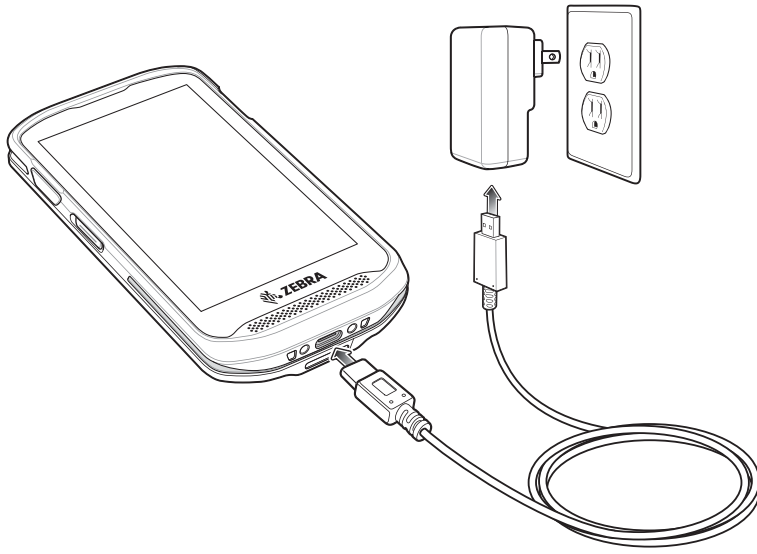

Charging Indicators

Table 4 Charging/Notification LED Charging Indicators

State	LED	Indication
Off		TC25 is not charging. TC25 is not inserted correctly in the cradle or connected to a power source. Charger/cradle is not powered.
Slow Blinking Amber (1 blink every 4 seconds)		TC25 is charging.
Slow Blinking Red (1 blink every 4 seconds)		TC25 is charging but the battery is at end of useful life. See system administrator for battery replacement services.
Solid Green		Charging complete.
Solid Red		Charging complete but the battery is at end of useful life. See system administrator for battery replacement services.
Fast Blinking Amber (2 blinks/second)		Charging error, e.g.: <ul style="list-style-type: none"> • Temperature is too low or too high. • Charging has gone on too long without completion (typically eight hours).
Fast Blinking Red (2 blinks/second)		Charging error but the battery is at end of useful life., e.g.: <ul style="list-style-type: none"> • Temperature is too low or too high. • Charging has gone on too long without completion (typically eight hours). See system administrator for battery replacement services.

Google Account Setup



NOTE The TC25 has to be connected to the internet in-order to set up a Google™ account.

The first time the TC25 starts, the Setup Wizard displays. Follow the on-screen instructions to set up a Google account, configure Google Wallet for purchasing items from the Play Store, entering your personal information, and enabling backup/restore features.

Replacing the microSD Card

To replace the microSD card:

1. Press the Power button until the menu appears.
2. Touch **Power off**.
3. Touch **OK**.
4. If hand strap is attached, remove the hand strap.
5. Using a 0# Phillips screwdriver, remove two screws securing the access door.

Figure 14 Remove Access Door

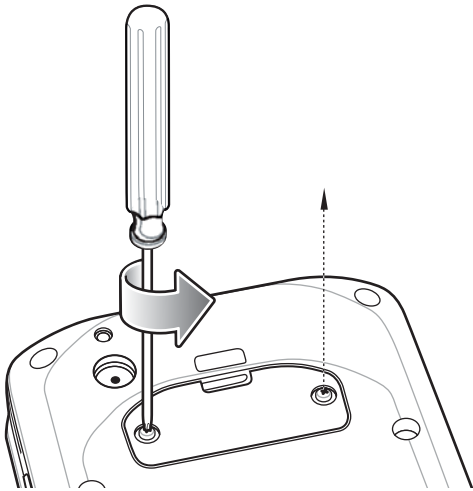

6. Remove access door.
7. Slide the microSD card out of the SD card slot.

Figure 15 Remove microSD Card

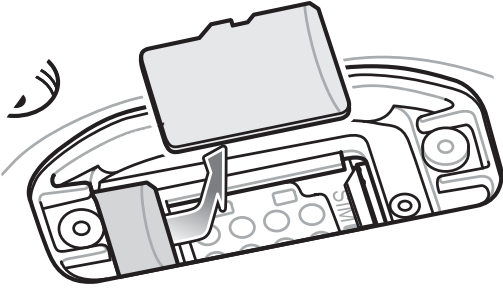

8. Lift the microSD card.
9. Align the replacement microSD card with the SD card slot.

Figure 16 Align microSD Card

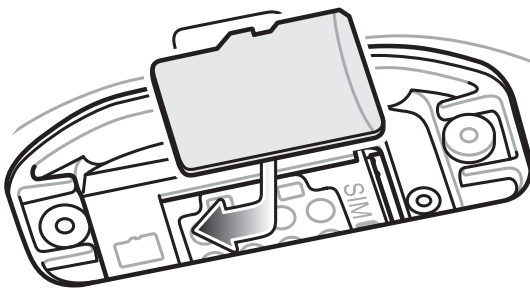

10. Push the microSD card into the SD card slot.

Figure 17 Push microSD Card into the SD Card Slot

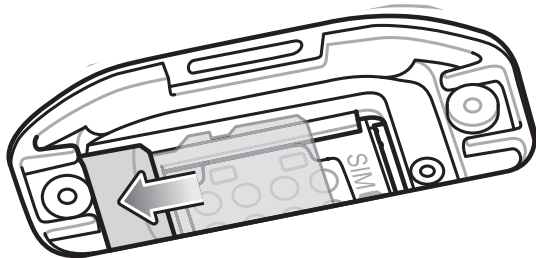

11. Replace the access Door.
12. Secure the access door using the two screws.

Figure 18 Secure Access Door

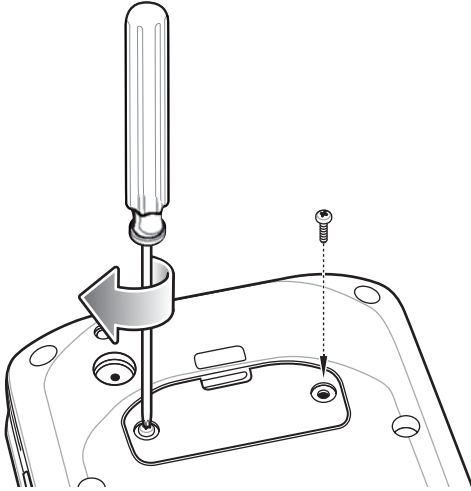

13. Replace the hand strap, if required.
14. Press and hold the Power button to turn on the TC25.

Replacing the SIM Card



NOTE Only use a nano SIM card.



CAUTION Access door must be replaced and securely seated to ensure proper device sealing.
TC25 must be powered off when replacing the SIM card.

To replace the SIM card:

1. Press the Power button until the menu appears.
2. Touch **Power off**.
3. Touch **OK**.
4. If hand strap is attached, slide the hand strap clip up toward the top of the TC25 and then lift.
5. Using a 0# Phillips screwdriver, remove two screws securing the access door.

Figure 19 Remove Access Door

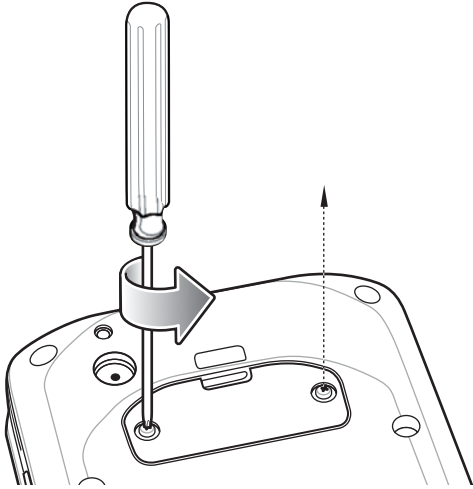

6. Push the SIM card in to eject the card.
7. Remove the SIM card from the slot.
8. Align the replacement SIM card with the SIM card slot with the contacts facing down and the cut edge toward the top of the device.

Figure 20 Align SIM Card with Slot

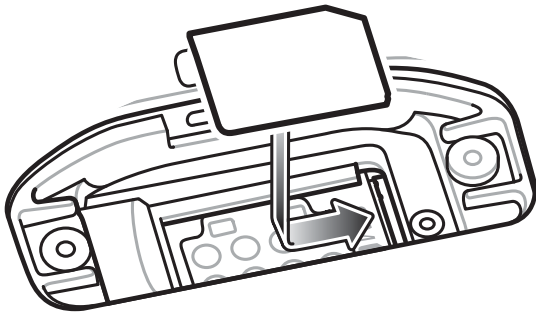

9. Push the SIM card in until it locks into the slot.

Figure 21 Push SIM Card into Slot

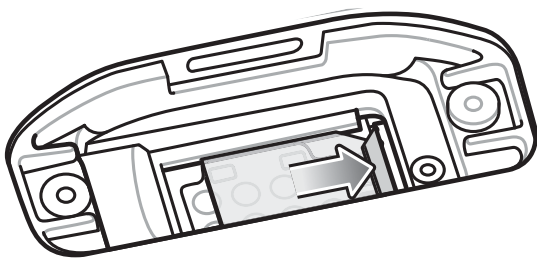

10. Re-install the access door.

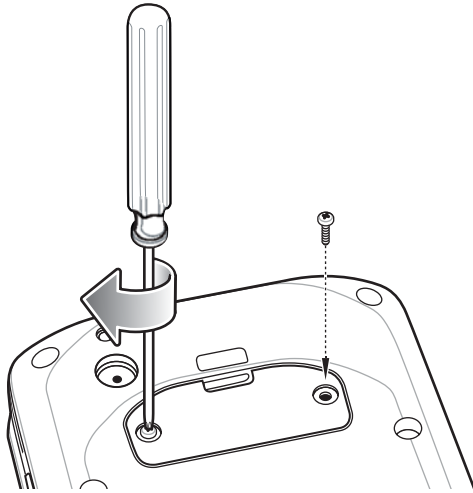

Figure 22 Replace Access Door



11. Replace the hand strap, if required.
12. Press and hold the Power button to turn on the TC25.

Accessing Device Settings

Throughout this guide, the user can access device settings:

1. Swipe down from the status bar and then touch .
2. On the Home screen, swipe up from the bottom of the screen and touch .

Battery Management



NOTE Prior to checking the battery charge level, remove the TC25 from any AC power source (cradle or cable).

To check the charge status of the main battery, open Settings and touch  **About phone > Battery Management**.

Battery status indicates that the battery is discharging and **Battery level** lists the battery charge (as a percentage of fully charged).

Monitor Battery Usage

The **Battery** screen lists which applications consume the most battery power. Also use it to turn off applications that were downloaded if they are consuming too much power.



1. Swipe down from the status bar and then touch .
2. Touch  **Battery**.

Figure 23 Battery Screen

The **Battery** screen lists the applications using the battery. The discharge graph at the top of the screen shows the rate of the battery discharge since last charged (short periods of time when connected to a charger are shown as thin green lines at the bottom of the chart), and how long it has been running on battery power.

Touch an application in the **Battery** screen to display details about its power consumption. Different applications display different information. Some applications include buttons that open screens with settings to adjust power use.

Low Battery Notification

When the battery charge level drops below 20%, the TC25 displays a notice to connect the TC25 to power. The user should charge the battery using one of the charging accessories.

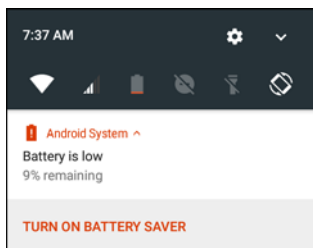
Figure 24 Low Battery Notification

When the battery charge drops below 10%, the TC25 displays a notice to connect the TC25 to power. The user must charge the battery using one of the charging accessories.

When the battery charge drops below 4%, the TC25 turns off.

The user must charge the TC25 using one of the charging accessories.

Battery Optimization

Observe the following battery saving tips:

- Disable DataWedge Launcher profile. Refer to the TC25 Rugged Smartphone Integrator Guide for Android 7.1.2 for instructions.
- Set the screen to turn off after a short period of non-use. See [Setting Screen Timeout Setting on page 29](#).

- Set the TC25 to turn off when not in use. See [Scheduled Power On and Off on page 51](#).
- Reduce screen brightness. See [Setting the Screen Brightness on page 28](#).
- Turn off all wireless radios when not in use.
- Turn off automatic syncing for Email, Calendar, Contacts and other applications.
- Minimize use of applications that keep the TC25 from suspending, for example, music and video applications.



Turning Off the Radios

To turn off all the radios:

1. Press the Power button until the menu appears.
2. Touch **Airplane mode**. The airplane icon  appears in the Status bar indicating that all the radios are off.

Setting the Date and Time

The date and time is automatically synchronized using a NITZ server when the TC25 is connected to a cellular network. The user is only required to set the time zone or set the date and time when not connected to a cellular network or if the wireless LAN does not support Network Time Protocol (NTP).

1. Swipe down from the status bar and then touch .
2. Touch  **Date & time**.
3. Touch **Automatic date & time** to disable automatic date and time synchronization.
4. Touch **Set date**.
5. In the calendar, set today's date.
6. Touch **OK**.
7. Touch **Set time**.
8. Touch the green circle, drag to the current hour and then release.
9. Touch the green circle, drag to the current minute and then release.
10. Touch **AM** or **PM**.
11. Touch **OK**.
12. Touch **Automatic time zone** to disable automatic date and time synchronization.
13. Touch **Select time zone**.
14. Select the current time zone from the list.
15. Touch .

Display Setting

Use Display settings to change the screen brightness, change the background image, enable screen rotation, set sleep time and change font size.

Setting the Screen Brightness



To manually set the screen brightness:

1. Swipe down with two fingers from the status bar to open the quick access panel.
2. Slide the icon to adjust the screen brightness level.

Figure 25 Brightness Slider





To let the TC25 automatically adjust the screen brightness using the built-in light sensor:

1. Swipe down from the status bar and then touch .
2. Touch  **Display**.
3. Touch **Brightness Level**.
4. Touch **Adaptive brightness** to automatically adjust the brightness.
5. Touch .



Setting Screen Rotation

By default, screen rotation is disabled. To enable screen rotation:

1. Swipe down from the status bar and then touch .
2. Touch  **Display**.
3. Touch **When device is rotated** and select **Rotate to contents of the screen** to set the TC25 to automatically switch orientation when the TC25 is rotated.
4. Touch .

Setting Screen Timeout Setting

To set the screen sleep time:

1. Swipe down from the status bar and then touch .
2. Touch  **Display**.
3. Touch **Sleep**.
4. Select one of the sleep values.
 - **15 seconds**
 - **30 seconds**
 - **1 minute** (default)
 - **2 minutes**
 - **5 minutes**
 - **10 minutes**
 - **30 minutes**
5. Touch .

Setting Font Size

To set the size of the font in system applications:





1. Swipe down from the status bar and then touch .
2. Touch  **Display**.
3. Touch **Font size**.

Figure 26 Font Settings

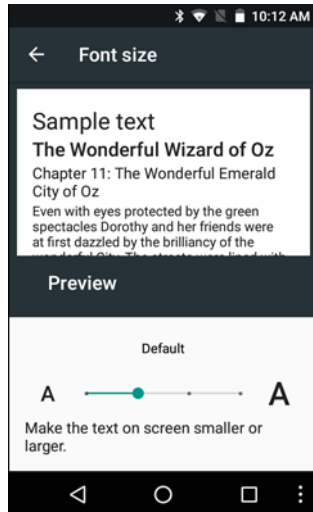

4. Select one of the font size values.
 - **Small**
 - **Default** (default)
 - **Large**
 - **Largest**
5. Touch .

General Sound Setting

Use the **Sounds** settings to configure media and alarm volumes.



1. Swipe down from the status bar and then touch .
2. Touch  **Sounds**.

Figure 27 Sound and Notification Screen



- **Media volume** - Controls the music, games and media volume.
- **Alarm volume** - Controls the alarm clock volume.
- **Ring volume** - - Controls the ringtone volume.
- **Also vibrate for calls** - Turn on the switch to make the device vibrate when a call is received (default – disabled).
- **Do not disturb** - Mutes the TC25 so that it does not make sounds or vibrate when you do not want it to.
 - **Priority only allows** - Use to set priorities.
 - **Alarms** - Disabled.
 - **Reminders** - Switch on or off.
 - **Events** - Switch on or off.
 - **Messages** - Choose from anyone, starred contacts, any contact, or none. To star contacts, use the Contacts app.
 - **Calls** - Choose from anyone, starred contacts, any contact, or none. To star contacts, use the Contacts app.
 - **Repeat callers** - Choose whether to let the TC25 ring if the same person calls again within 15 minutes.
 - **Automatic rules** - To automatically silence the TC25 during certain times, like at night or on weekends. Touch a default rule Weekend or Weeknight. Or, to make your own rule, tap Add rule and then Time rule.
 - **Block visual disturbances**
 - **Block when screen is on** - option pertains to notifications you receive when you are actively using the device. If you would like to disable the banner like notifications when Do not Disturb is enabled, turn this option On. This will also prevent you from peeking at notifications.
 - **Block when screen is off** - option pertains to notifications you receive when you are not using your device i.e. the display is asleep. If you want to prevent the display from waking up when a new notification is received, turn this option On. This will additionally disable the LED light alerts your phone sends you when you have new notifications.
- **Phone ringtone** - Touch to select a sound to play for incoming calls.
- **Default notification ringtone** - Touch to select a sound to play for all system notifications.
- **Default alarm ringtone** - Touch to select a sound to play for alarms.

- **Emergency broadcasts** - Touch to configure emergency broadcast settings and notifications.
- **Other sounds**
 - **Dial pad tones** - Play a sound when pressing keys on dial pad (default - disabled).
 - **Screen locking sounds** - play a sound when locking and unlocking the screen (default – enabled)
 - **Charging sounds** - Not applicable.
 - **Touch sounds** - Play a sound when making screen selections (default – enabled).
 - **Vibrate on tap** - Device vibrates when making screen selections (default – disabled).

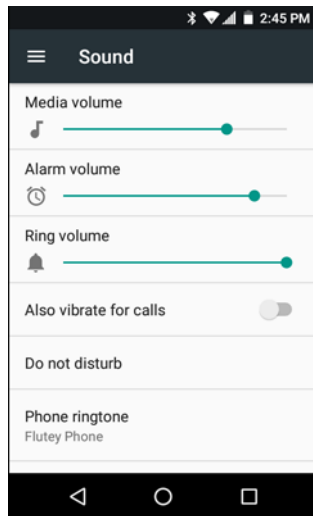
Wake-Up Sources

By default the TC25 wakes from suspend mode when the user presses the power button. The TC25 can be configured to wake when the user presses the PTT on the left side of the device or one of the Scan buttons.



1. Swipe down from the status bar and then touch .
2. Touch  **Wake-Up Sources**.
3. Touch **Keypad** checkbox. A check appears in the checkbox.

Figure 28 Wake-Up Sources



4. Touch .

Using the TC25

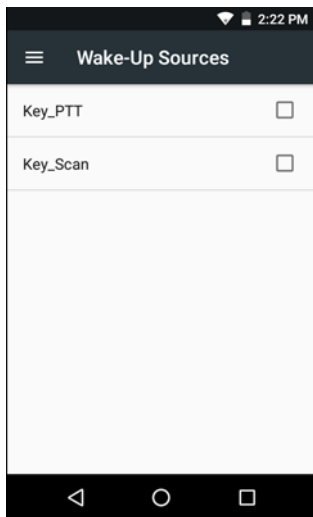
This chapter explains the buttons, status icons, and controls on the TC25, and provides basic instructions for using the TC25 including resetting the TC25 and entering data.

Google Mobile Services

The TC25 with GMS contains applications and services that provide additional functionality to the TC25.

GMS includes:

- **Applications** - GMS adds a variety of Google applications and associated widgets including Chrome, Gmail, Drive and Maps.
- **Services:**
 - **Speech to Text** - Allows for free format speech to text, in many languages for both connected and disconnected network. Launch by touching the microphone icon on the keyboard.
 - **TalkBack Service** - Provides spoken feedback on various parts of the user interface. To enable, go to **Settings > Accessibility**.
 - **Network Location Provider** - Adds a location provider which uses mobile network tower information and Wi-Fi access point information to provide a location without using GPS. To enable, go to **Settings > Location**.
 - **Widevine DRM** - Enables the digital rights management so that protected content can be played. Enable via DRM Info from the Play Store.
 - **Google Cloud Messaging** - Allows the sending of data from your server to your TC25 and also to receive messages from devices on the same connection.
 - **Backup and Restore** - Allows the users settings and applications to be backed up to a Google server and subsequently restored from that server after a factory reset.
- **Google accounts** - Create and use a Google account to synchronize mail, files, music, photos, contacts and calendar events.

Home Screen

The Home screen displays when the TC25 turns on. Depending upon the configuration, the Home screen might appear different. Contact your system administrator for more information.

After a suspend or screen time-out, the Home screen displays with the lock sliders. Touch the screen and slide up to unlock. For screen locking information see [Un-Locking the Screen on page 50](#).



Figure 29 Home Screen**Table 5** Home Screen Items

Item	Description
1 — Status Bar	Displays the time, status icons (right side), and notification icons (left side). For more information see Status Bar on page 35 and Managing Notifications on page 37 .
2 — Widgets	Launches stand-alone applications that run on the Home screen. See Application Shortcuts and Widgets on page 40 for more information.
3 — Back	Displays the previous screen.
4 — Home	Displays the Home screen.
5 — Recent Button	Displays recently used applications.
6 — All Apps	Opens the APPS window.
7 — Shortcut Icons	Opens applications installed on the TC25. See Application Shortcuts and Widgets on page 40 for more information.
8 — Folder	Contains apps.

The Home screen provides four additional screens for placement of widgets and shortcuts. Swipe the screen left or right to view the additional screens.

Setting Home Screen Rotation

By default the Home screen rotation is disabled. To enable Home screen rotation:

1. Touch and hold anywhere on the Home screen until the options appear.
2. Touch .
3. Touch Allow rotation switch.
4. Touch .

5. Rotate the device.

Figure 30 Rotated Home Screen



Status Bar

The Status bar displays the notification icons (left side), time and status icons (right side).



NOTE Some status icons may not appear in the Status bar if there are too many icons to display.





Figure 31 Notification and Status Icons



If there are more notifications than can fit in the Status bar , displays indicating that more notifications exist. Open the Notifications panel to view all notifications and status.





















Status Icons

Table 6 Status Icons

Icon	Description
	Indicates that the Alarm is active.
	Indicates that the main battery is fully charged.
	Indicates that the main battery is partially drained.
	Indicates that the main battery charge is low.
	Indicates that the main battery charge is very low.

Note 1: Cellular network icon that appears is dependent upon the carrier/network.

















Table 6 Status Icons (Continued)

Icon	Description
	Indicates that the main battery is charging.
	Indicates that all sounds except media and alarms are silenced and vibrate mode is active.
	Indicates that the Airplane Mode is active. All radios are turned off.
	Indicates that Bluetooth is on.
	Indicates that the TC25 is connected to a Bluetooth device.
	Connected to a Wi-Fi network.
	Not connected to a Wi-Fi network or no Wi-Fi signal.
	Connected to an Ethernet network.
	Portable Wi-Fi Hotspot is active.
	Mobile network signal strength.
	No mobile network signal.
	Connected to a 4G LTE network (see Note 1).
	Connected to a DC -HSPA, HSDPA, HSPA+, HSUPA, LTE or WCMDMA network (see Note 1).
	Connected to a WCDMA network (see Note 1).
	Connected to an DC - HSPA, HSDPA, HSPA+ or HSUPA network (see Note 1).
	Connected to an EDGE network (see Note 1).
	Connected to a GPRS network (see Note 1).
	Connected to a GPRS network (see Note 1).
	Roaming from a network.
	No SIM card installed.

Note 1: Cellular network icon that appears is dependent upon the carrier/network.

Notification Icons

Table 7 Notification Icons

Icon	Description
	Indicates the main battery is low.
	Indicates that more notifications are available for viewing.
	Indicates that data is syncing.
	Indicates an upcoming event.
	Indicates that an open Wi-Fi network is available.
	Indicates that a song is playing.
	Indicates that a problem with sign-in or sync has occurred.
	Indicates that the TC25 is uploading data.
	Indicates that the TC25 is downloading data when animated and download is complete when static.
	Indicates that USB tethering is active.
	Indicates that the TC25 is connected to or disconnected from virtual private network (VPN).
	Preparing Internal Storage.
	Indicates that USB debugging is enabled on the TC25.
	USB Headset is connected to device.
	Indicates the status of the PTT Express Voice Client. See Notification Icons for complete list of PTT Express notification icons.
	Indicates that RxLogger application is running.
	Indicates a Bluetooth scanner is connected to the TC25.

Managing Notifications

Notification icons report the arrival of new messages, calendar events, and alarms, as well as ongoing events. When a notification occurs, an icon appears in the Status bar with a brief description. See [Notification Icons on page 37](#) for a list of possible notification icons and their description. Open the Notifications panel to view a list of all the notifications.

To open the Notification panel drag the Status bar down from the top of the screen.

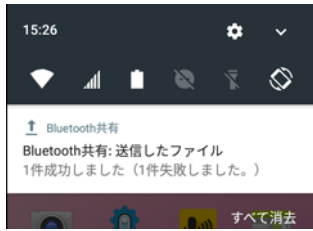
Figure 32 Notification Panel

To respond to a notification, open the Notifications Panel and then touch a notification. The Notifications Panel closes and the subsequent activity is dependent on the notification.

To clear all notifications, open the Notifications Panel and then touch **CLEAR ALL**. All event-based notifications are removed. Ongoing notifications remain in the list.

Ongoing notifications remain in the list.

To close the Notification Panel, swipe the Notifications Panel up.

Setting Application Notifications

To change notification settings for a specific app:

1. Swipe down from the status bar and then touch .
2. Touch **Notifications**.
3. Select an app.
4. Select an available option:
 - **Block all**
 - **Show silently**
 - **On the lock screen**
 - **Override Do Not Disturb.**





IMPORTANT In the notification, slide the notification slightly left or right and touch .

Viewing Notification Settings for All Apps

1. Swipe down from the status bar and then touch .
2. Touch **Notifications**.
3. Touch down-arrow next to **All apps**.
4. To see all the apps currently set to a specific setting, touch that setting.

Controlling Lock Screen Notifications

To control notification content on the lock screen:

1. Swipe down from the status bar and then touch .
2. Touch **Notifications** > .
3. Touch **On the lock screen**.
4. Select **Show all notification content** to or select **Don't show notifications at all**.

Quick Settings

Use Quick Settings to get to frequently used settings, like turning on airplane mode. To open Quick Settings bar, swipe down from the top of the screen with two fingers or twice with one finger.

Figure 33 Quick Settings Bar



To see the full Quick Settings panel:

- If the TC25 is locked, swipe down once.
- If the TC25 is unlocked, swipe down once with 2 fingers, or twice with one finger.
- If the Quick Settings bar is open, touch the Down arrow.

Figure 34 Full Quick Settings



Available setting tiles:

- Display brightness: Slide to lower or increase the brightness of the screen.
- Wi-Fi network: Turn Wi-Fi on or off. To open Wi-Fi settings, touch the Wi-Fi network name.
- Bluetooth settings: Turn Bluetooth on or off. To open Bluetooth settings, touch the **Bluetooth**.
- Do not disturb: Control how and when to receive notifications.
- Cellular Network: Displays the cellular carrier name and signal information. **No SIM card** indicates that a SIM card is not installed or activated.
- Airplane mode: Turn airplane mode on or off. Airplane mode means device will not connect to Wi-Fi or Bluetooth.
- Auto-rotate: Lock the device's orientation in portrait or landscape mode or set to automatically rotate.
- Flashlight: Turn camera flash on or off.
- Location: Enable or disable locationing feature.
- Hotspot - Turn mobile hotspot on or off.
- Invert colors - Invert the display colors.
- Data Saver - Turn on to prevent some apps from sending or receiving data in the background.
- Night Light - Tint the screen amber to make it easier to look at the screen in dim light. Set Night Light to turn on automatically from sunset to sunrise, or at other times.

- Nearby - Helps find and interact with services and devices close to the device.



Edit Icons on Quick Settings

The first several setting tiles become the Quick Settings bar.



To move a setting tile:

1. Touch and drag a setting tile to another location.
2. Release the tile.
3. Touch  to save tiles and return to quick settings.

To add a setting tile:

1. Open Quick Settings.
2. Touch .
3. Slide Quick Settings panel up to reveal additional tiles.
4. Touch and drag a setting tile from the **Drag to add tiles** area to the main area.
5. Release the tile.
6. Touch  to save tiles and return to quick settings.

To remove a setting tile:

1. Open Quick Settings.
2. Touch .
3. Touch and drag a setting tile to the **Drag here to remove** area.
4. Release the tile.
5. Touch  to save tiles and return to quick settings.

Application Shortcuts and Widgets

Application shortcuts placed on the Home screen allow quick and easy access to applications. Application Widgets are self-contained applications placed on the Home screen to access frequently used features.

Adding an Application to the Home Screen

1. Go to the desired Home screen.
2. Swipe up from the bottom of the screen.
3. Scroll through the list to find the application icon.
4. Touch and hold the icon until the Home screen appears.
5. Position the icon on the screen and then release.

Adding a Widget to the Home Screen

To add a widget to the Home screen:

1. Go to the desired Home screen.
2. Touch and hold until the menu appears.
3. Touch **WIDGETS**.
4. Scroll through the list to find the widget.

5. Touch and hold the widget until the Home screen appears.
6. Position the widget on the screen and then release.

Moving Items on the Home Screen

1. Touch and hold the item until it floats on the screen.
2. Drag the item to a new location. Pause at the edge of the screen to drag the item onto an adjacent Home screen.
3. Lift finger to place the item on the Home screen.

Removing an Application Shortcut or Widget from the Home Screen

1. Go to the desired Home screen.
2. Touch and hold the application shortcut or widget icon until it floats on the screen.
3. Drag the icon to  削除 on the top of the screen and then release.

Folders

Use **Folders** to organize similar applications together. Tap the folder to open and display items in the folder.

Creating a Folder

To create a folder, there must be at least two app icons on the Home screen.

1. Go to the desired Home screen.
2. Touch and hold on one application icon.
3. Drag the icon and stack on top of another icon.
4. Lift and release.

Naming Folders

To name a folder:

1. Touch the folder.

Figure 35 Open Folder

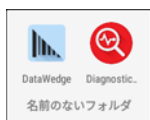

2. Touch the title area and enter a folder name using the keyboard.
3. Touch  on the keyboard.
4. Touch anywhere on the Home screen to close the folder. The folder name appears under the folder.

Figure 36 Renamed Folder



Removing a Folder

To remove a folder:

1. Touch and hold the folder icon until it enlarges.
2. Drag the folder to  删除 and release.

Home Screen Wallpaper

To change the Home screen wallpaper:

1. Touch and hold on the screen until the menu appears.
2. Touch **WALLPAPERS**.
3. Touch **My photos** to select a photo from Gallery or select one of the pre-installed photos.
4. Touch **Save wallpaper**.

Using the Touchscreen

Use the multi-tap sensitive screen to operate the device.

- **Tap** - Tap to:
 - select items on the screen
 - type letters and symbols using the on-screen keyboard
 - press on-screen buttons.
- **Tap and Hold** - Tap and hold:
 - an item on the Home screen to move it to a new location or to the trash.
 - an item in Apps to create a shortcut on the Home screen.
 - the Home screen to open a menu for customizing the Home screen.
 - an empty area on the Home screen until the menu appears.
- **Drag** - Tap and hold an item for a moment and then move finger on the screen until reaching the new position.
- **Swipe**- Move finger up and down or left and right on the screen to:
 - unlock the screen
 - view additional Home screens
 - view additional application icons in the Launcher window
 - view more information on an application's screen.
- **Double-tap** - Tap twice on a web page, map, or other screen to zoom in and out.
- **Pinch** - In some applications, zoom in and out by placing two fingers on the screen and pinching them together (to zoom out) or spreading them apart (to zoom in).

On-Screen Keyboards



Use the on-screen keyboard to enter text in a text field.

Editing Text

Edit entered text and use menu commands to cut, copy, and paste text within or across applications. Some applications do not support editing some or all of the text they display; others may offer their own way to select text.

Entering Numbers, Symbols and Special Characters

To enter numbers and symbols:

- Touch and hold one of the top-row keys until a menu appears then select a number. Keys with alternate characters display an ellipsis (...) below the character.
- Touch and hold the Shift key with one finger, touch one or more capital letters or symbols to enter them, and then lift both fingers to return to the lowercase keyboard.
- Touch  to switch to the numbers and symbols keyboard.
- Touch the  key on the numbers and symbols keyboard to view additional symbols.

To enter special characters, touch and hold a number or symbol key to open a menu of additional symbols.

- A larger version of the key displays briefly over the keyboard.
- Keys with alternate characters display an ellipsis (...) below the character.

Switching Language Keyboards

The user can enable multiple language keyboards. The available language codes appear on the space bar.

Figure 37 Keyboard with Multiple Languages

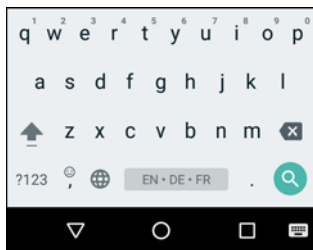

To switch between language keyboard, touch  at the bottom right corner of the screen.

Figure 38 Change Keyboard Option



Select one of the keyboard languages. The keyboard automatically changes to the selected language.

Configuring the Keyboard

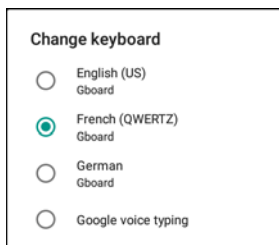
To configure the keyboard, See the Keyboard Settings section in the TC25 Rugged Smartphone Integrator Guide for Android Version 7.1.2.

GMS Keyboard

To configure the keyboard settings, touch and hold  (comma) >  and then select **Gboard Keyboard settings**.

Do Not Disturb Feature

This mode mutes the TC25 so that it does not make sounds or vibrate.

For example, use Do Not Disturb to:

- Automatically limit sounds at night or during events
- Mute interruptions other than alarms
- Get alerted to messages only from favorite contacts.

Limit Sounds and Vibrations

Mute the TC25 completely, or let through the important alarms or important calls.

Total Silence

To completely mute the TC25 so that it does not make a sound or vibrate, choose **Total silence**.

In Total silence mode:

- Alarms do not make noise.
- TC25 does not vibrate or make sounds when receiving a message, or notification.
- Sounds from music, videos, games, and other media are muted.



NOTE: The user will not hear alarms in Total silence mode.

1. Swipe down with two fingers from the status bar to open the quick access panel.
2. Touch **Do not disturb > Total silence**.
3. Choose **Until you turn it off** or select a time period.
4. Touch **Done**.

When Total Silence is on,  appears in the quick access panel and the Status Bar.

To turn off Total Silence, open quick access panel and touch **Total silence**.

Alarms Only

To mute the TC25 so that the user hears alarms, choose **Alarms only**. This option does not mute sounds from music, videos, games, or other media.

1. Swipe down with two fingers from the status bar to open the quick access panel.
2. Touch **Do not disturb > Alarms only**.
3. Choose **Until you turn it off** or select a time period.
4. Tap **Done**.

When Alarms Only is on,  appears in the quick access panel and the Status Bar.

To turn off Alarms Only, open quick access panel and touch **Alarms only**.





NOTE: To quickly turn on Alarms Only, with the screen on, press and hold the Volume Down button until the volume is all the way down. Then, press Volume Down again to turn on Alarms Only.

To turn off Alarms Only, press either the Volume Up or Volume Down button and the touch **END NOW** in the alert message. Then, press Volume Up again to turn on Alarms Only.

Priority Notifications Only

To only be interrupted by important notifications, choose Priority Only. This option does not mute sounds from music, videos, games, or other media.

Before turning on Priority Only mode, set the notification priorities:

1. Swipe down from the status bar and then touch .
2. Touch  **Sounds** > **Do not disturb** > **Priority only allows**.
3. Set priorities.
 - **Alarms:** Disabled by default.
 - **Reminders** and **Events:** Switch on or off.
 - **Messages:** Choose **From anyone**, **From contacts only**, **From starred contacts only**, or **none**. To star contacts, use the **Contacts** app.
 - **Calls:** Choose **From anyone**, **From contacts only**, **From starred contacts only**, or **none**. To star contacts, use the **Contacts** app.
 - **Repeat callers:** Choose whether to let the TC25 ring if the same person calls again within 15 minutes.

After setting notification priorities, turn on Priority only mode to limit interruptions. The priority notifications make a sound or vibrate based on the current ringer volume, but other notifications will be silenced.

1. Swipe down with two fingers from the status bar to open the quick access panel.
2. Touch **Do not disturb** > **Priority only**.
3. Choose **Until you turn it off** or select a time period.
4. Tap **Done**.



When Priority Only is on,  appears in the quick access panel and the Status Bar.

To turn off Priority Only, open quick access panel and touch **Priority only**.

Automatically Block Sounds and Vibrations

Silence Sounds During Certain Times



To automatically silence the TC25 during certain times, like at night or on weekends, set the time rules.

1. Swipe down from the status bar and then touch .
2. Touch  **Sounds** > **Do not disturb** > **Automatic rules**.
3. Touch a default **Weekend** or **Weeknight**. Or, to make a new rule, touch **Add rule** and then **Time rule**.
4. Edit the new rule:
 - **Rule name:** Name the rule.
 - **Days, Start time, and End time:** Set the rule's schedule.



- **Do not disturb:** Choose whether the rule uses **Alarms only**, **Priority only**, or **Total silence**.
5. Touch the On/Off text or switch at the top to turn on the rule.

Silence Sounds During Events and Meetings

To automatically silence the TC25 during events or meetings, set an event rule.

1. Swipe down from the status bar and then touch .
2. Touch  **Sounds** > **Do not disturb** > **Automatic rules**.
3. To edit the default rule, touch **Event**. Or, to create a new rule, touch **Add rule** > **Event rule**.
4. Edit the rule settings.
 - **During events for:** Select which Google Calendar events the rule uses.
 - **Where reply is:** Options: **Yes**, **Maybe**, or **Not replied**, **Yes or Maybe**, or **Yes**.
 - **Do not disturb:** Choose whether the rule uses **Priority only**, **Alarms only**, or **Total silence**.
5. Touch the On/Off switch at the top to turn on the rule.

Turn Sounds Back On

When the TC25 is in Do Not Disturb mode, Alarms or Priority only  or Total silence  display.

To turn off Do Not Disturb, either:

- In the quick access panel, touch **Alarms only**, **Priority only**, or **Total silence**.
- Press the Volume Down button and touch **End Now**.

Override Do Not Disturb for Specific Apps

To let through notifications from specific apps:

1. Open **Settings** > **Notifications**.
2. Touch an app.
3. Touch **Override Do Not Disturb**.

Applications

The **APPS** screen displays icons for all installed applications. The table below lists the applications installed on the TC25. Refer to the TC25 Rugged Smartphone Integrator Guide for Android Version 7.1 for information on installing and uninstalling application.

Table 8 Applications











Icon	Description
	Bluetooth Pairing Utility – Use to pair a Bluetooth Imager with the TC25 by scanning a barcode.
	Calculator - Provides the basic and scientific arithmetic functions.
	Camera - Take photos or record videos. For more information see Camera on page 73 .
	Chrome - Use to access the Internet or intranet.
	Clock - Use to schedule alarms for appointments or as a wake-up.
	Contacts - Use to manage contact information. See Contacts on page 71 for more information.
	DataWedge - Enables data capture using the imager.
	Diagnostic Tool - Use to diagnose the TC25. Refer to the TC25 Rugged Smartphone Integrator Guide for Android Version 7.1.2 for more information.
	Downloads - lists all downloads files.
	Drive - Upload photos, videos, documents, and other files to personal storage site.
	Duo - A one-to-one video calling application.

Table 8 Applications (Continued)





















Icon	Description
	DWDemo - Provides a way to demonstrate the data capture features using the imager. See DataWedge Demonstration on page 83 for more information.
	File Browser - Organize and manage files on the TC25. See File Browser on page 67 for more information.
	Gmail - Use to send and receive email using a Google email account.
	Google - Launches Google search application.
	Maps - Use to see you location on a map (with public transit, traffic or satellite overlays). Search for any business or place of interest. Provides turn-by-turn navigation with voice guidance and traffic-avoidance and alternate routes, for drivers, cyclist, walkers and users of public transportation.
	Messaging - Send SMS and MMS messages. See Messaging on page 69 for more information.
	Notes - Use to take and save notes.
	Phone - Use to make cellular calls or to dial a phone number when used with some Voice over IP (VoIP) clients.
	Photos - Use to sync photos with Google account.
	Play Movies & TV - View movies and video on your device.
	Play Music - Use to listen to music.
	Play Store - Download music, movies, books, and Android apps and games from the Google Play™ Store.
	PTT Express - Use to launch PTT Express client for VoIP communication.

Table 8 Applications (Continued)

Icon	Description
	RxLogger - Use to diagnose device and application issues. See the TC25 Rugged Smartphone Integrator Guide for Android Version 7.1.2 for more information.
	RxLogger Utility - Use to diagnose device and application issues. See the TC25 Rugged Smartphone Integrator Guide for Android Version 7.1.2 for more information.
	Settings - Use to configure the TC25.
	Sound Recorder - Use to record audio.
	StageNow - Allows the TC25 to stage a device for initial use by initiating the deployment of settings, firmware and software.
	TC25 User Guide - Opens the on-device User Guide for the TC25.
	Voice Search - Use to perform searches by asking questions.
	YouTube™ - Use to view videos on the YouTube web site.

Accessing Applications

All applications installed on the device are accessed using the **APPS** window.

1. Swipe up from the bottom of the Home screen.

Figure 39 APPS Window Example

2. Slide the **APPS** window left or right to view more application icons. Touch an icon to open the application.
See [Application Shortcuts and Widgets on page 40](#) for information on creating a shortcut on the Home screen.

Switching Between Recent Applications

1. Touch . A window appears on the screen with icons of recently used applications.

Figure 40 Recently Used Applications

2. Slide the window up and down to view all recently used applications.
3. Swipe left or right to remove application from the list and force close the application.
4. Touch an icon to open it or touch to return to the current screen.

Un-Locking the Screen

Use the Lock screen to protect access to data on the TC25. Some email account require locking the screen. Refer to the TC25 Rugged Smartphone Integrator Guide for Android Version 7.1.2 for information on setting up the locking feature.

When locked, a pattern, PIN or password is required to unlock the device. Press the Power button to lock the screen. The device also locks after a pre-defined time-out.

Press and release the Power button to wake the device. The Lock screen displays. Swipe the screen up to unlock. If the Pattern screen unlock feature is enabled, the Pattern screen appears instead of the Lock screen. If the PIN or Password screen unlock feature is enabled, enter the PIN or password after unlocking the screen.

Figure 41 Lock Screen



Figure 42 PIN Screen Example

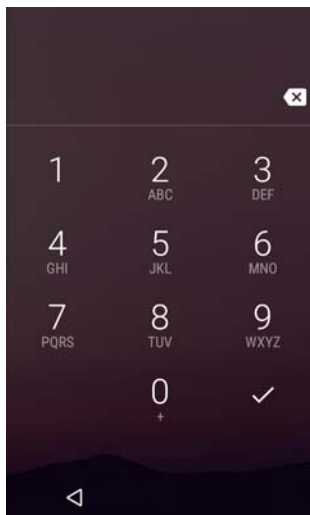

Scheduled Power On and Off

The user can set the TC25 to turn on or off at a specific time. This can save battery power when the TC25 is not in use.

To set the power on and off schedule:





1. Swipe down from the status bar and then touch .
2. Touch  **Scheduled power on and off.**

Figure 43 Scheduled Power On and Off

3. In the **Scheduled power on** section, touch the on/off switch.

Figure 44 Set Power Schedule

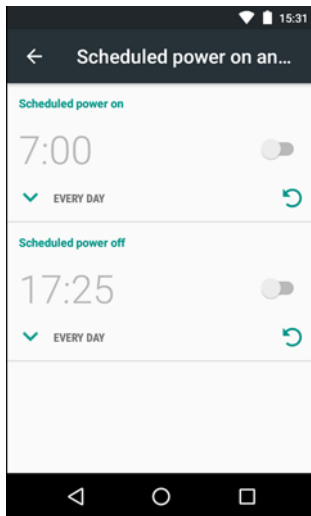
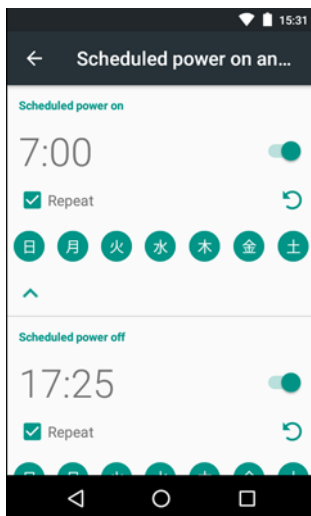
4. Touch the time.
5. Use the clock dialog box to set the power on time and touch **Done**. by default, the power on time occurs everyday.
6. Touch the day circles disable power on for a specific day.
7. Deselect the **Repeat** checkbox to disable daily repeating and set the TC25 power on at the next set time.
8. Repeat for scheduled power off settings.
9. Touch .

When the TC25 starts automatic power off, a dialog box appears.

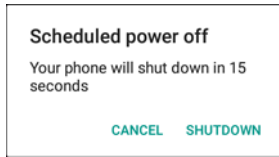
Figure 45 Power Off

Touch **Shutdown** to power off, Cancel to not power off or the device powers off automatically after a 20 seconds.

Resetting the Device

There are two reset functions, soft reset and hard reset.

Performing a Soft Reset

Perform a soft reset if applications stop responding.

1. Press and hold the Power button until the menu appears.
2. Touch **Reset**.
3. The device reboots.

Performing a Hard Reset



CAUTION Performing a hard reset with a microSD card installed in the TC25 may cause damage or data corruption to the microSD card.

Perform a hard reset if the TC25 stops responding.

1. Simultaneously press the Power and Volume Up buttons for at least five seconds.
2. When the screen turns off, release the buttons.
3. The TC25 reboots.

Suspend Mode

The TC25 goes into suspend mode when the user presses the Power button or after a period of inactivity (set in the Display settings window).

To wake the TC25 from Suspend mode, press the Power button. The Lock screen displays. Swipe the screen up to unlock. If the Pattern screen unlock feature is enabled, the Pattern screen appears instead of the Lock screen. If the PIN or Password screen unlock feature is enabled, enter the PIN or password after unlocking the screen.



NOTE If the user enters the PIN, password or pattern incorrectly five times, they must wait 30 seconds before trying again.

If the user forgets the PIN, password or pattern contact the system administrator.

Transferring Files with a Host Computer via USB

Connect the TC25 to a host computer using the USB Charging cable or the 1-Slot USB cradle to transfer files between the TC25 and the host computer. See [Accessories](#) for more information.

When connecting the TC25 to a host computer, follow the host computer's instructions for connecting and disconnecting USB devices, to avoid damaging or corrupting files.

Transferring Files using Media Transfer Protocol

✓ **NOTE** Use Media Transfer Protocol (MTP) to copy files between the TC25 (internal memory or microSD card) and the host computer.

1. Connect the Rugged Charge/USB Cable to the TC25 or place the TC25 into the 1-Slot USB/Charge Only Cradle. See [Accessories](#) for setup information.
2. Pull down the Notification panel and touch **USB charging this device**.

Figure 46 Use USB Dialog Box

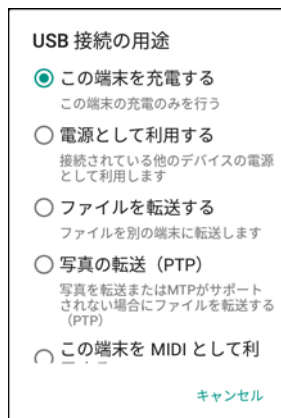

3. Touch **Transfer files**.
4. On the host computer, open a file explorer application.
5. Locate the **TC25** as a portable device.
6. Open the **SD card** or the **Internal storage** folder.
7. Copy files to and from the TC25 or delete files as required.

Transferring Files using Photo Transfer Protocol

✓ **NOTE** Use Photo Transfer Protocol (PTP) to copy photos from either the microSD card or internal memory to the host computer.

1. Connect the USB Cable to the TC25 or place the TC25 into the 1-Slot Ethernet Cradle. See [Accessories](#) for setup information.
2. Pull down the Notification panel and touch **USB charging this device**.

Figure 47 Use USB Dialog Box

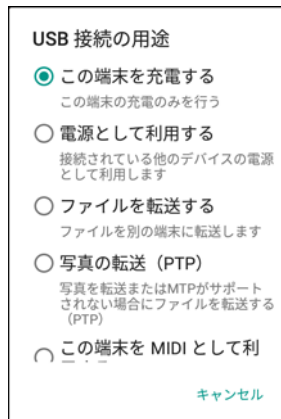

3. Touch **Transfer photos (PTP)**.
4. On the host computer, open a file explorer application.
5. Open the **SD card** or the **Internal storage** folder.
6. Copy or delete photos as required.

Disconnect from the Host Computer



CAUTION Carefully follow the host computer's instructions to unmount the microSD card and disconnect USB devices correctly to avoid losing information.

1. On the host computer, unmount the device.
2. Remove the USB Charging cable from the device or remove the device from the cradle.

Calls

Make a phone call from the **Phone** application, the **Contacts** application or other applications or widgets that display contact information.

Emergency Calling

The service provider programs one or more emergency phone numbers, such as 911 or 999, that the user can call under any circumstances, even when the phone is locked, a SIM card is not inserted or the phone is not activated. The service provider can program additional emergency numbers into the SIM card. However, the SIM card must be inserted in the device in order to use the numbers stored on it. See the service provider for additional information.



NOTE: Emergency numbers vary by country. The phone's pre-programmed emergency number(s) may not work in all locations, and sometimes an emergency call cannot be placed due to network, environmental, or interference issues.

Audio Modes

The device offers three audio modes for use during phone calls:

- **Handset Mode:** Switches audio to the receiver at the top front of the device, so the user can use the device as a handset. This is the default mode.
- **Speaker Mode:** Use the device as if on speaker phone.
- **Headset Mode:** Connect a Bluetooth ear bud headset to automatically switch audio to the headset.

Using a Bluetooth Headset

Use a Bluetooth headset for audio communication when using an audio-enabled application. See [Bluetooth on page 112](#) for information on connecting a Bluetooth headset to the device. Set the volume appropriately before putting on the headset. When a Bluetooth headset is connected, the speakerphone is muted.

Adjusting Audio Volume

Use the Volume buttons to adjust the volume of the ringer when not in a call and the audio volume when in a call.



NOTE: Adjust the conversation phone volume during a call. Adjusting the volume while not in a call affects the ring and notification sound levels.

Making a Call Using the Dialer

Use the dialer tab to dial phone numbers.



1. On the Home screen touch .
2. Touch .

Figure 48 Dialer Screen







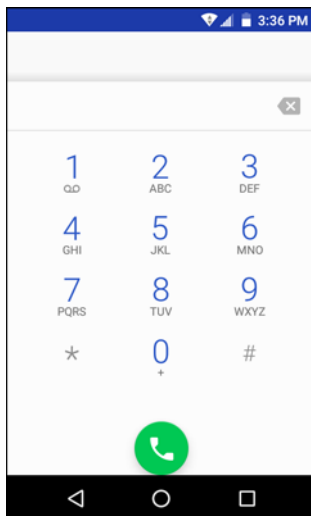

3. Touch the keys to enter the phone number.
4. Touch  below the dialer to initiate the call.

Figure 49 Call in Progress

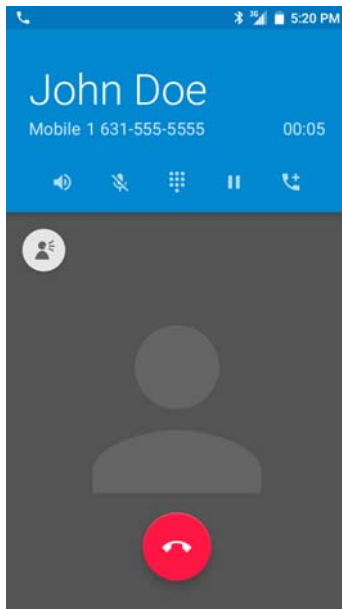



-  - touch to send audio to the speakerphone.
-  - touch to mute the call.
-  - touch to display the dial pad.
-  - touch to place the call on hold (not available on all services).
-  - touch to create a conference call.
-  - touch to turn volume boost on or off.

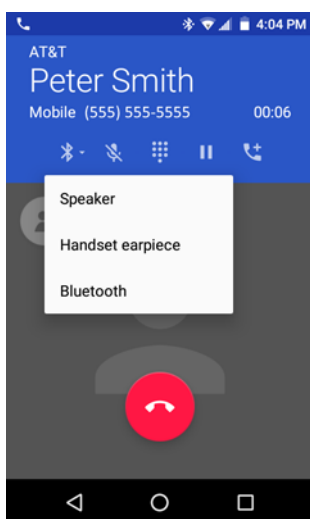

5. Touch  to end the call.

If using a Bluetooth headset, additional audio options are available. Touch the audio icon to open the audio menu.

Figure 50 Bluetooth Audio Options



-  - indicates that audio is routed to the Bluetooth headset.

-  - indicates that audio is routed to the speakerphone.
-  - indicates that audio is routed to the earpiece.

Dialer Dialing Options

The dialer provides options to save the dialed number to contacts, insert pauses and wait into the dial string and options for setting the Call settings. Enter at least one digit to access these options. Touch  to access the following:

- **Add 2-sec pause** - pause the dialing of the next number for two seconds. Multiple pauses can be added sequentially.
- **Add wait** - wait for confirmation to send the rest of the digits.

Making a Call Using Contacts

There are two ways to make a call using contacts:

- Using the Dialer
- Using the Contacts application.

Using the Dialer





1. On the Home screen touch .
2. Touch the  tab.

Figure 51 Dialer Contacts Tab

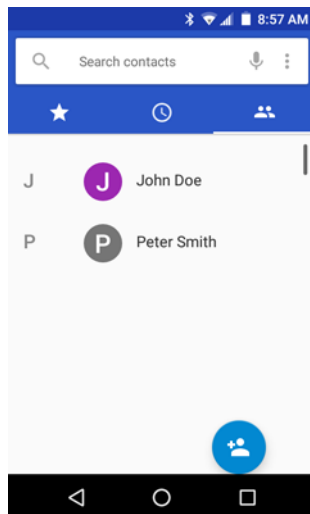

3. Touch the contact.
4. Touch  to initiate the call.
5. Touch  to end the call.

Using the Contacts Application

To make a call from the Contacts application:

1. Touch .

Figure 52 Contact Application



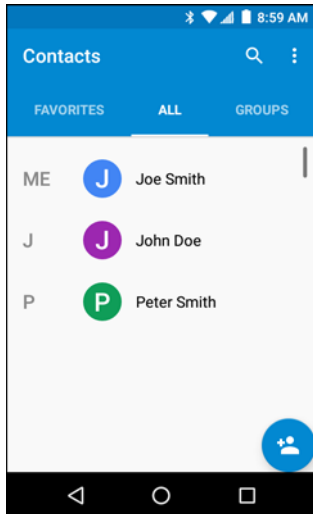

2. Touch a contact name.
3. Touch to initiate a call.

Making a Call Using Call History

Call History is a list of all the calls placed, received, or missed. It provides a convenient way to redial a number, return a call, or add a number to Contacts.

Arrow icons beside a call indicate the type of call. Multiple arrows indicate multiple calls:

-  - Missed incoming call
-  - Received incoming call
-  - Outgoing call.





1. On the Home screen touch .
2. Touch the  tab.

Figure 53 Call History Tab

3. Touch  next to the contact to initiate the call.
4. Touch the contact to perform other functions.
5. Touch  to end the call.

Making a Conference Call

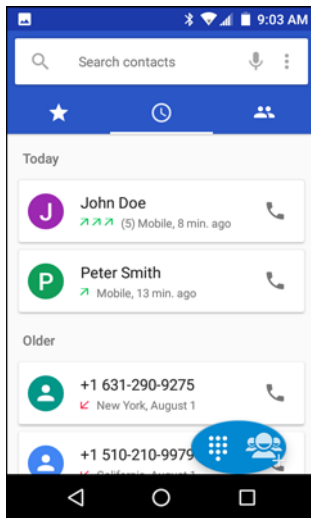
To create a conference phone session with multiple people.



NOTE: Conference Calling and the number of conference calls allowed may not be available on all services. Please check with the service provider for Conference Calling availability.

On the Home screen touch .





1. Touch .
2. Touch the keys to enter the phone number.
3. Touch  below the dialer to initiate the call.
4. When the call connects, touch .
5. Select a contact or touch  and enter the second phone number.
6. Touch  below the dialer to initiate the call. The first call is placed on hold.
7. When the call connects, the first call is placed on hold and the second call is active.

Figure 54 Two Calls



8. Touch  icon to create a conference call with three people.

Figure 55 Merged Calls

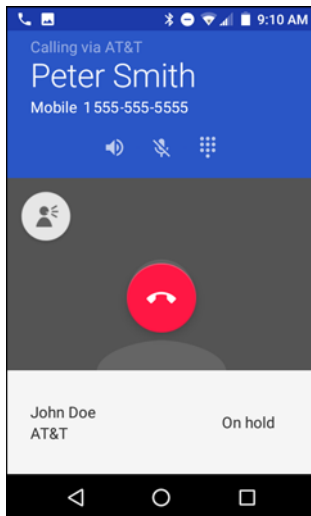





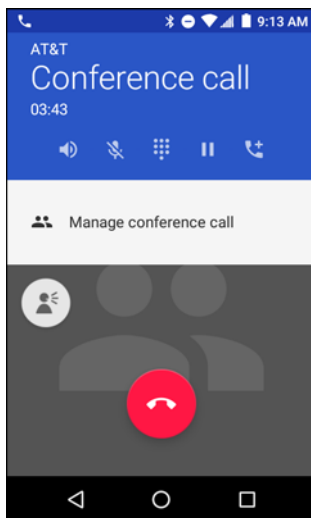

9. Touch  to add another call.
The conference is placed on hold.
10. Touch the keys to enter the another phone number.
11. Touch  below the dialer to initiate the call.
12. Touch  to add the third call to the conference.
13. Touch Manage Conference call to view all callers.

Figure 56 Un-merge Calls

14. To remove a caller from the conference, touch  next to the caller.

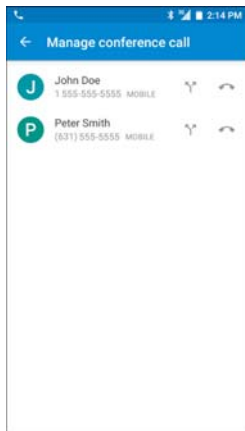
To speak privately with one party during a conference call, touch . To include all parties again, touch .

Making a Call Using a Bluetooth Headset

To make a call using a Bluetooth headset:

1. Pair the Bluetooth headset with the device.
2. Press the Call button on the Bluetooth headset.
3. Say “Call” and then the number or contact name.
4. Press the Call button on the Bluetooth headset to end the call.

Answering Calls

When you receive a phone call, the Incoming Call screen displays, displaying the caller ID and any additional information about the caller that is in the Contacts application.

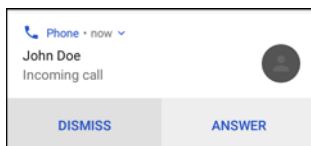
Figure 57 Incoming Call Screen



Touch **Answer** to answer the call or **Dismiss** to send the caller to voice mail.

If the screen lock is enabled, the user can still answer the call without unlocking the device.

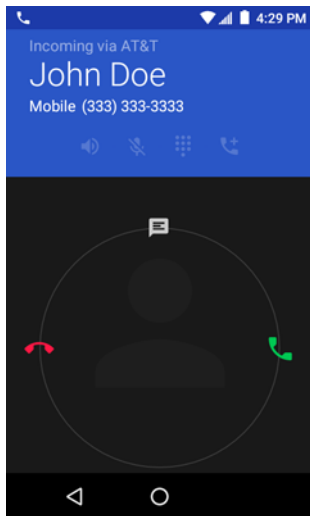
Figure 58 Incoming Call Locked Screen



When a call arrives, touch the white phone icon and slide over one of these icons:

-  Answer call - Start talking to the caller.
-  Send to voice mail - Direct the caller to leave a voice mail message.
-  Send a message - Opens a list of quick text responses. Touch one to send it to the caller immediately.

When the calls ends, the device remains locked.

If using a Bluetooth headset, when a call arrives, touch the Call button on the Bluetooth headset to answer the call. To end the call press the headset Call button.

All incoming calls are recorded in the Phone application Call log tab. If you miss a call, you receive a notification. To silence the ringer before answering the call, press the volume down button on the side of device.

Call Settings



IMPORTANT: Not all options are available for all configurations.

Use the Call Settings to modify options related to the phone call feature.

Use the Call Settings to modify options related to the phone call feature. On the **Call** home screen, touch  **Settings**.

Display Options

- **Sort by** - Options: First name or Last name.
- **Name format** - Options: First name first or Last name first.

Sounds and Vibrations

- **Phone ringtone** - Touch to select a ringtone to sound when an incoming call is received.
- **Also vibrate for calls** - Check to make the device vibrate when a call is received (default - disabled).
- **Dialpad tones** - Check to play a sound when a phone key is touched (default - enabled).

- **Dialpad tone length** - Select dialpad tone length. Options: **Normal** or **Long**.

Quick Responses

Touch to edit quick responses to use instead of answering a call.

Speed Dial Settings

Set speed dial contact shortcuts.

Calls

- **Calling accounts**
 - **SIP accounts** - Choose to receive Internet calls for accounts added to the device, view or change SIP accounts, or add an Internet calling account.
 - **Use SIP calling** - Options: **For all calls** or **Only for SIP calls** (default).
 - **Receive incoming calls** - When enabled, allows incoming calls (default - disabled).
- **Voicemail** - Touch to configure voicemail settings.
 - **Service** - Set the service provider or other provider for voicemail service.
 - **Setup** - Touch to update the phone number used to access voicemail.
 - **Sound** - Touch to select a sound to play when a voicemail is received.
 - **Vibrate** - Set vibrate option. (default – disabled).
- **Fixed Dialing Numbers** - Use Fixed Dialing to restrict the device to dial only the phone number(s) or area code(s) specified in a Fixed Dialing list.
- **Wi-Fi Calling** - Enable the TC25 to route calls via Wi-Fi networks or carrier's network, depending upon preference and signal strength. Check with your carrier first.
- **GSM call settings**
 - **Call forwarding** - Use call forwarding to forward incoming calls to a different phone number.



IMPORTANT: Call Forwarding may not be available on all networks. Check with the service provider for availability.

- **Additional settings**
 - **Caller ID** - Enable caller ID to reveal the identity of the person making an outgoing call. Options: **Network default** (default), **Hide number**, **Show number**.
 - **Call waiting** - set to be notified of an incoming call while on a call.
- **Call barring** - Use call barring to block certain types of incoming and/or outgoing calls. Select the type of incoming and/or outgoing calls to block.

Call Blocking

If you don't want to get calls from a certain phone number, you can block it. When the number tries to call you, your phone declines the call automatically.

Touch **ADD NUMBER** to add phone number that you want to block.

Accessibility

- **TTY mode** - Touch to set the TTY setting. Use an optional teletypewriter (TTY) device with the TC25 to send and receive calls. Plug the TTY device into an adapter and into the TC25 USB C port and set the TC25 to operate in one of the TTY modes.



IMPORTANT: Use a TSB-121 compliant cable (provided by the TTY manufacturer) to connect the TTY device to the TC25.

Set the TC25 volume to a middle level setting for proper operation. If you experience a high number of incorrect characters, adjust the volume as needed to minimize the error rate.

For optimal performance, the TC25 should be at least 30 cm (12 inches) from the TTY device. Placing the TC25 too close to the TTY device may cause high error rates.

- **TTY off** - TTY is off (default).
- **TTY Full** - Transmit and receive TTY characters.
- **TTY HCO** - Transmit TTY characters but receive by listening to earpiece.
- **TTY VCO** - Receive TTY characters but transmit by speaking into microphone.
- **Hearing aids** - Turn on or off hearing aid compatibility.

Applications

This section describes the applications installed on the device.

File Browser

Use the **File Browser** application to view and manage files on the device.



Swipe up from the bottom of the Home screen and touch .

Figure 59 File Browser Screen



The address bar indicates the current folder path. Touch the current folder path to manually enter a path and folder name.

Use  to select multiple files/folder.

Use  to view the device root folder.

Use  to view internal storage folder.

Use  to view the previous folder or to exit the application.

Touch and hold an item to perform an operation on that item. Select one of the options from the **File Operations** menu:

- **Information** - View detailed information about the file or folder.
- **Move** - Move the file or folder to a new location.

- **Copy** - Copy the select file.
- **Delete** - Delete the selected file.
- **Rename** - Rename the select file.
- **Open as** - Open the selected file as a specific file type.
- **Share** - Share the file with other devices.

Touch  to open menu options:

- **New Folder** - Create a new folder.
- **Search** - Search for a specific file on the device.
- **Sort** - Select the sort order of the files by name, type, size or date.
- **Refresh** - Refresh the current folder.
- **List View** - Change the folder to display item is a list. Appears only in Grid view.
- **Grid View** - Change the folder to display item is a grid. Appears only in List view.
- **Change Size** - Change the size of the icons.
- **About File Browser** - Displays the app version.

Messaging

Use Messaging to send and receive SMS and MMS messages. From a Home or All Apps screen, touch .

Sending a Text Message

1. In the main Messaging screen, touch .

Figure 60 New Text Message Screen

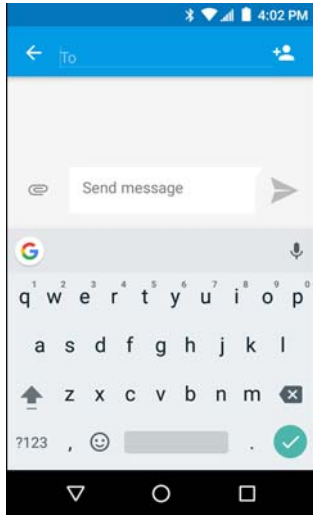

2. In the **To** field, enter a name or a mobile phone number.
3. In the **Send message** field, enter the text message.
The 160-character limit counter indicates how many characters are left. If it goes over that limit, a new message is created, which is joined with its predecessors when received.
If the user presses the Back button while composing a message, it's saved as a draft in the Messaging screen. Touch the conversation to resume composing it.
4. Touch  to send the message.

Sending a Multimedia Message





1. In the main Messaging screen, touch .
2. In the **To** field, enter a name or a mobile phone number.
3. Touch  to attach the media file of your choice:

Figure 61 New Multimedia Message Screen

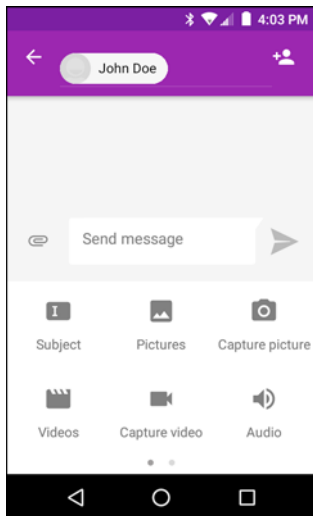

- **Subject** - Add a subject for the message.
 - **Pictures** - Select a picture to attach.
 - **Capture picture** - Camera opens to take a picture and attach it.
 - **Videos** - Select a video to attach.
 - **Capture video** - Camcorder opens to record a video and attach it to the message.
 - **Audio** - Choose a sound file to attach.
 - **Record audio** - Sound Recorder opens to record a spoken message and attach it to the message.
 - **Slideshow** - Opens a screen to assemble text, photos, videos, and recordings into a slideshow of up to 10 slides to attach to the message.
 - **Insert contact info** - Send a contact's phone information as text.
 - **Contact vCard** - Send a contact's information as a vCard.
 - **Import Template** - Send a pre-defined message.
 - **Calendar** - Send a calendar event.
4. Touch  to send the message.

Contacts

Use the **Contacts** application to manage contacts.



From a Home or Apps screen, touch . People opens to the main list of contacts. View contacts in three ways at the top of the screen: Groups, All contacts, and Favorites. Touch the tabs to change how to view the contacts. Swipe up or down to scroll through the lists.



Figure 62 Contacts Screen

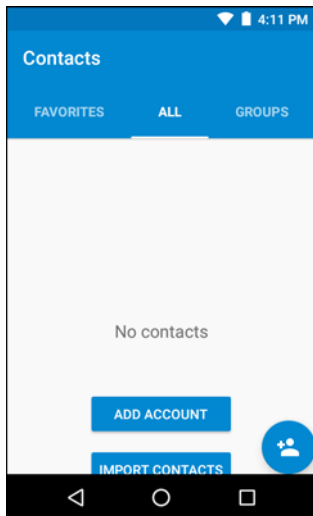

Adding a Contact

1. In the **Contacts** application, touch .
2. If there are more than one account with contacts, touch the one to use.
3. Type the contact's name and other information. Touch a field to start typing, and swipe down to view all categories.
4. To open a menu with preset labels, such as Home or Work for an email address, touch the label to the right of the item of contact information. Or, to create your own label, touch **Custom** in the menu.
5. Touch .

Editing Contacts

1. In the **Contacts** application, touch a contact name to edit.
2. Touch .
3. Edit the contact information.
4. Touch .

Deleting Contacts

1. In the **Contacts** application, touch a contact name to delete.
2. Touch .
3. Touch **Delete**.

4. Touch **Delete** to confirm.

Camera



IMPORTANT Camera application is available only on configurations with cameras.

This section provides information for taking photos and recording videos using the integrated digital cameras.



NOTE If a microSD card is installed, The TC25 saves photos and videos on the microSD card. If a microSD card is not installed, the TC25 saves photos and videos on the internal storage.

Taking Photos



NOTE Camera settings are described in [Photo Settings on page 75](#).



1. Swipe up from the bottom of the Home screen and touch .

Figure 63 Camera Mode

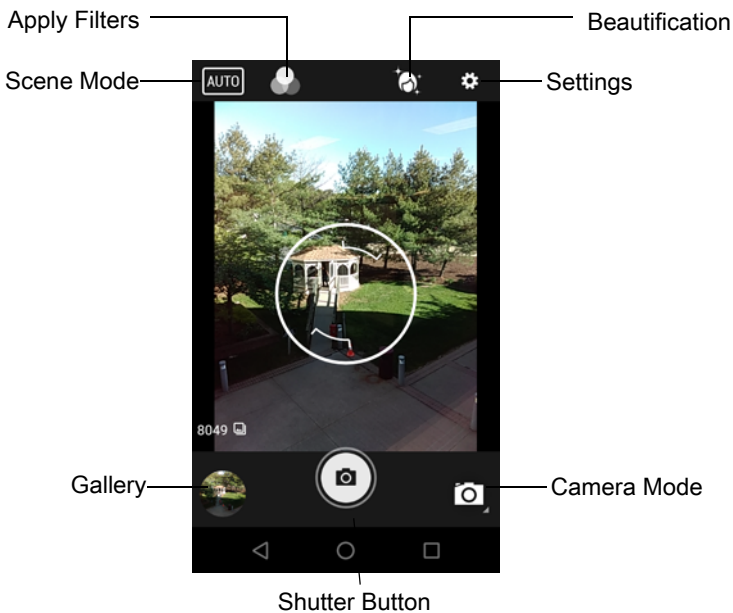

2. If necessary, touch the Camera Mode icon and touch .
 3. Frame the subject on the screen.
 4. To zoom in or out, press two fingers on the display and pinch or expand fingers. The zoom controls appear on the screen.
 5. Touch an area on the screen to focus. The focus circle appears on the screen. The two bars turn green when in focus.
 6. Touch .
- The camera takes a photo and a shutter sound plays.
The photo momentarily displays as a thumbnail in the lower left corner.

Taking a Panoramic Photo

Panorama mode lets the user create a single wide image by panning slowly across a scene.





1. Swipe up from the bottom of the Home screen and touch .
2. Touch the Camera Mode and touch .

Figure 64 Panoramic Mode

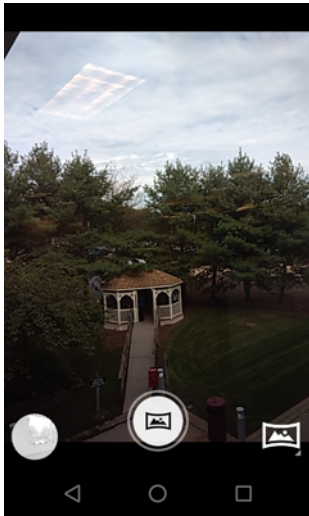

3. Frame one side of the scene to capture.
4. Touch  and slowly start panning across the area to capture. A small white square appears inside the button indicating the capture is in progress.
If panning too quickly, the message **Too fast** appears.
5. Touch  to end the shot. The panorama appears immediately and a progress indicator displays while it saves the image.

Recording Videos

To record a video:



1. Swipe up from the bottom of the Home screen and touch .
2. Touch the Camera Mode and touch .

Figure 65 Video Mode







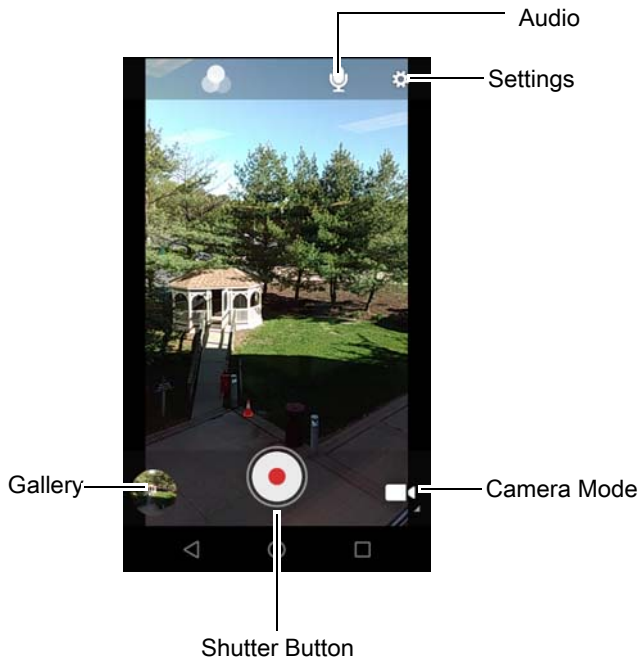





3. Point the camera and frame the scene.
4. To zoom in or out, press two fingers on the display and pinch or expand fingers. The zoom controls appear on the screen.
5. Touch  to start recording.
The device starts recording the video. The video time remaining appears in the top left of the screen.
6. Touch  to end recording.
The video momentarily displays as a thumbnail in the lower left corner.

Photo Settings



When in Photo mode, photo settings are displayed on screen. Touch  to display the photo settings options.





- **Flash** - Touch to set whether the camera relies on its light meter to decide whether a flash is necessary, or to turn it on or off for all shots.
 -  **Off** - Disable flash.
 -  **Auto** - Camera adjusts flash automatically depending upon light meter (default).
 -  **On** - Enable flash upon taking a photo.
- **Picture size** - Touch to set the size (in pixels) of the photo. Options: **8M pixels** (default), **5M pixels**, **4M pixels (16:9)**, **3M pixels**, **HD 1080**, **2M pixels**, **1.5M pixels**, **1.3M pixels**, **WXGA**, **HD 720**, **1M pixels**, **SVGA**, **WVGA**, **720 x 480**, **VGA**, **CIF** or **QVGA**.
- **Picture quality** - Touch to select picture quality setting. Options: **Low**, **Standard** (default) or **High**.
- **Countdown timer** - Select amount of time after pressing the camera button that the photo is taken. Options: **Off** (default), **2 seconds**, **5 seconds** or **10 seconds**.
- **Storage** - Touch to select location to store the photo. Options: **Phone** (default) or **SD Card**.
- **Continuous Shot** - Select to take a series of photos quickly while holding the capture button. Options: **Off** (default) or **On**.

- **Face Detection** - Select to enable face detection. Options: **Off** (default) or **On**.
- **ZSL** - Set the camera to immediately take a picture when the button is pressed (default – enabled)
- **Focus mode** - Disabled.
- **Anti Banding** - Select to prevent the appearance of vertical or horizontal lines (banding) when photographing images on TV and monitor screens. Options: **Off** (default), **50 Hz**, **60 Hz**, or **Auto**.
- **ISO** - Set how sensitive the camera is to light. Options: **Auto** (default), **ISO Auto (HJR)**, **ISO100**, **ISO200**, **ISO400**, **ISO800** or **ISO1600**.
- **Exposure** - Touch to adjust the exposure settings. Options: **+2**, **+1**, **0**(default), **-1** or **-2**.
- **White balance** - Touch to select how Camera adjusts colors in different kinds of light, to achieve the most natural-looking colors.
 -  **Incandescent** - Adjust the white balance for incandescent lighting.
 -  **Fluorescent** - Adjust the white balance for florescent lighting.
 -  **Auto** - Adjust the white balance automatically (default).
 -  **Daylight** - Adjust the white balance for daylight.
 -  **Cloudy** - Adjust the white balance for a cloudy environment.
- **Chroma Flash** - Select to simultaneously take a flash and a non-flash version of the same subject and combine these two images to improve the quality of flash photography. Options: **Off** (default) or **On**.
- **Redeye Reduction** - Select to reduce the red-eye phenomenon when using the flash. Options: **Disable** (default) or **Enable**. Disabled when **Chroma Flash** is enabled.
- **Shutter Sound** - Select to play a shutter sound when taking a photo. Options: **Disable** (default) or **Enable**.

Video Settings

When in Video mode, video settings are displayed on screen. Touch  to display the video settings options.

- **Flash** - Touch to set whether Rear-facing Camera relies on its light meter to decide whether a flash is necessary, or to turn it on or off for all shots.
 -  **Off** - Disable flash (default).
 -  **On** - Enable flash.
- **Video quality** - Touch to select video quality. Options: **HD 1080p** (default), **HD 720p**, **SD 480p**, **VGA**, **CIF**, or **QVGA**.
- **GPS location** - Include location information with each photo using the device global positioning system (GPS). Options: **On** (default) or **Off**.
- **Video duration** - Options: **30 seconds (MMS)**, **10 minutes** (default), **30 minutes** or **no limit**.
- **Storage** – Touch to select location to store the photo. Options: **Phone** (default) or **SD Card**.

- **White balance** - Touch to select how Camera adjusts colors in different kinds of light, to achieve the most natural-looking colors.
 -  **Incandescent** - Adjust the white balance for incandescent lighting.
 -  **Fluorescent** - Adjust the white balance for florescent lighting.
 -  **Auto** - Adjust the white balance automatically (default).
 -  **Daylight** - Adjust the white balance for daylight.
 -  **Cloudy** - Adjust the white balance for a cloudy environment.
- **Video High FrameRate** - Select a high frame rate for videos to capture movement more clearly. Options: **Off** (default), **HFR 60**, **HFR 90**, **HFR 120**, **HSR 60**, **HSR 90**, or **HSR 120**.
- **Image Stabilization** - Select to help stabilize zoom while shooting video. Options: **Off** (default), or **On**.

Photos

Use Photos to:

- view photos
- play videos
- perform basic editing of photos
- set photos as wallpaper
- set photos as a contact photo
- share photos and videos.

Photos presents all photos and videos stored on the microSD card and internal memory.

To open the **Photos** application, swipe up from the bottom of the Home screen and touch .

By default, Photos open to the **Photos** view.

Figure 66 Photos View

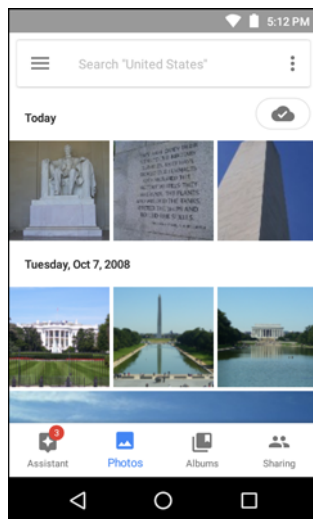

Touch **Albums** to view photos sorted by albums.

Figure 67 Albums View

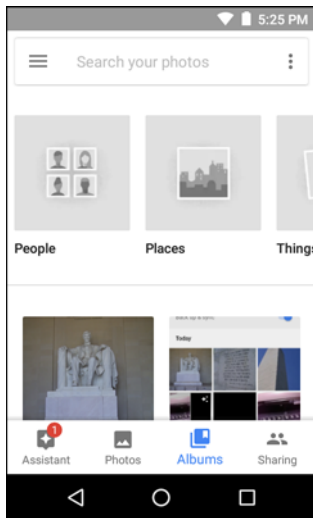

- Touch an album to open it and view its contents. The photos and videos in the album display in chronological order.
- Touch a photo or video in an album to view it.
- Touch ← to return to the main screen.

Working with Albums

Albums are groups of images and videos in folders. Touch an album to open it. The photos and videos are listed in a chronologically ordered grid. The name of the album displays at the top of the screen.

Figure 68 Photos Inside an Album

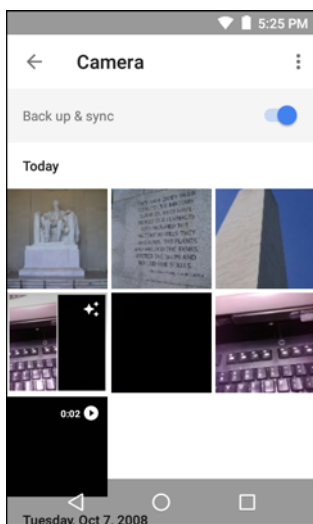

Swipe up to scroll images across the screen.

Deleting an Album

To delete an album and its contents:

1. Touch an album to open it.

2. Touch  > **Delete device folder**.
3. In the delete folder dialog box, touch **Delete**.

Working with Photos

Use Photos to view photos on the internal memory and the microSD card.

Viewing and Browsing Photos

To view a photo:

1. Touch an album to open it.
2. Touch a photo.

Figure 69 Photo Example



3. Swipe left or right to view the next or previous photo in the album.
4. Turn the device to view the photo in upright (portrait) or sideways (landscape) orientation. The photo is displayed (but not saved) in the new orientation.
5. Touch the photo to view the controls.
6. Pinch two fingers together or spread them apart to zoom in or out.
7. Drag the photo to view parts that are not in view.

Cropping a Photo



1. Touch a photo to view the controls.
2. Touch  > . The cropping tool appears.

Figure 70 Cropping Tool

3. Use the cropping tool to select the portion of the photo to crop.
 - Drag from the inside of the cropping tool to move it.
 - Drag an edge of the cropping tool to resize it to any proportion.
4. Touch **DONE**.
5. Touch **SAVE** to save a copy of the cropped photo. The original version is retained.

Setting a Photo as a Contact Icon

1. Touch the photo to open it.
2. Touch .
3. Touch **Use as**.
4. Touch **Contact photo**.
5. In the **Contacts** application, touch a contact.
6. Touch the white box and crop the photo accordingly.
7. Touch **Done**.

Share a Photo

1. Touch an album to open it.
2. Touch a photo to open it.
3. Touch .
4. Select additional photos, if required.
5. Touch a contact or application to use to share the selected photo. The application selected opens with the photo attached to a new message.

Deleting a Photo

1. Touch a photo to open it.
2. Touch .
3. Touch **Move to Trash** to delete the photo.

Working with Videos

Use **Photos** to view videos and share videos.

Watching Videos

1. Touch an album to open it.
2. Touch a video. The video automatically start playing.
3. Touch the screen to view the playback controls.

Sharing a Video

1. Touch an album to open it.
2. Touch a video to open it.
3. Touch . The Share menu appears.
4. Touch the application to use to share the selected video. The application selected opens with the video attached to a new message.

Deleting a Video

1. Touch an album to open it.
2. Touch a video to open it.
3. Touch .
4. Touch **Move to trash**.

DataWedge Demonstration



NOTE See the TC25 Rugged Smartphone Integrator Guide for Android Version 7.1.2 for information on DataWedge configuration.

Use **DataWedge Demonstration** to demonstrate data capture functionality.

Figure 71 DataWedge Demonstration Window

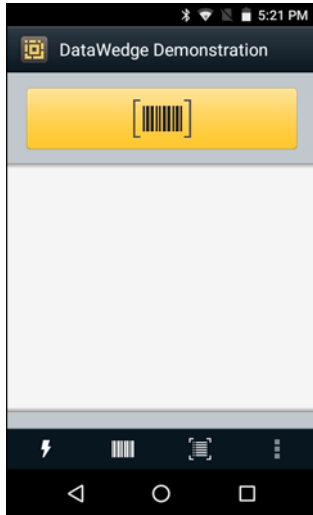
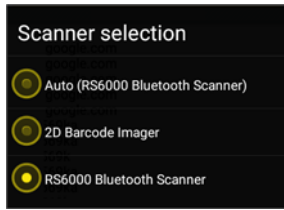

Table 9 DataWedge Demonstration Icons

Feature	Icon	Description
Illumination		Indicates imager illumination is off. Touch to turn illumination on.
		Indicates imager illumination is on. Touch to turn illumination off.
Data Capture		Indicates that the data capture function is through the internal imager.
		Indicates that a Bluetooth imager is not connected to the TC25.
		Indicates that a Bluetooth imager is connected to the TC25.
Scan Mode		Indicates imager is in picklist mode. Touch to change to normal scan mode.
		Indicates imager is in normal scan mode. Touch to change to picklist mode.
Menu		Opens a menu to view the application information or to set the application DataWedge profile.

Touch the Data Capture icon to select the data capture mode.

Figure 72 Data Capture Options Menu



Select a scanner to use. See [Data Capture](#) for configuring scanner options.

Either press the programmable button or touch the yellow scan button to enable data capture. The captured data appears in the text field below the yellow button.

Sound Recorder

Use **Sound Recorder** to record audio messages.

To open the **Sound Recorder** application, swipe up from the bottom of the Home screen and touch .

Recordings are saved on the microSD card (if installed) or the Internal Storage and available in the Music application playlist titled "Audio Recordings."

Figure 73 Sound Recorder Application

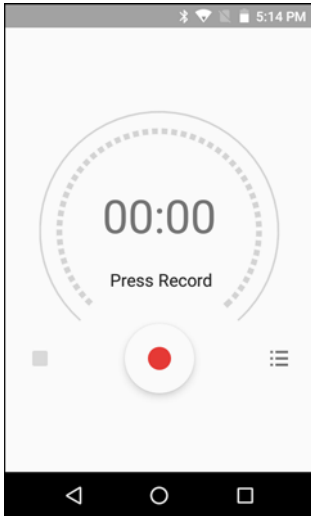

PTT Express Voice Client



NOTE PTT Express Voice Client creates Push-To-Talk (PTT) communication capability between disparate enterprise devices. Leveraging existing Wireless Local Area Network (WLAN) infrastructure, PTT Express delivers simple PTT communication without the need of a voice communication server.

- **Group Call:** Press and hold the PTT button to start communicating with other voice client users.
- **Private Response:** Double-press and the PTT button to respond to the originator of the last broadcast or to make a Private Response.

PTT Audible Indicators

The following tones provide helpful cues when using the voice client.

- **Talk Tone:** Double chirp. Plays when the Talk button is depressed. This is a prompt for the user to start talking.
- **Access Tone:** Single beep. Plays when another user just finished a broadcast or response. The user is now able to initiate a Group Broadcast or Private Response.
- **Busy Tone:** Continuous tone. Plays when the Talk button is depressed and another user is already communicating on the same talkgroup. Plays after the maximum allowed talk time is reached (60 seconds).
- **Network Tone:**
 - Three increasing pitch beeps. Plays when PTT Express has acquired the WLAN connection and the service is enabled.
 - Three decreasing pitch beeps. Plays when PTT Express has lost the WLAN connection or the service is disabled.

Figure 74 PTT Express Default User Interface

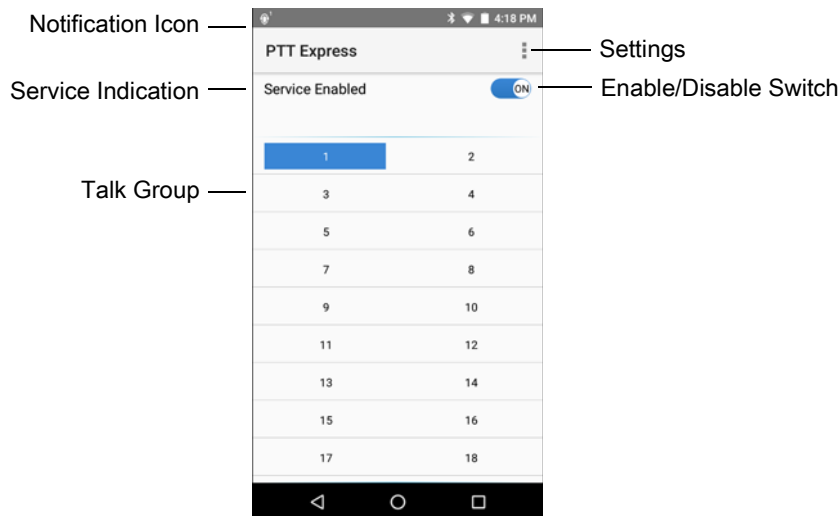









Table 10 PTT Express Default User Interface Descriptions

Item	Description
Notification Icon	Indicates the current state of the PTT Express client.
Service Indication	Indicates the status of the PTT Express client. Options: Service Enabled , Service Disabled or Service Unavailable .
Talk Groups	Lists all 32 Talk Groups available for PTT communication.
Settings	Opens the PTT Express Settings screen.
Enable/Disable Switch	Turns the PTT service on and off.

Notification Icons

Indicates the current state of the PTT Express Voice client.

Table 11 PTT Express Default User Interface Descriptions

Status Icon	Description
	Indicates that PTT Express Voice client is disabled.
	Indicates that PTT Express Voice client is enabled but not connected to a WLAN.
	Indicates that PTT Express Voice client is enabled, connected to a WLAN and listening on the Talk Group indicated by the number next to the icon.
	Indicates that PTT Express Voice client is enabled, connected to a WLAN and communicating on the Talk Group indicated by the number next to the icon.
	Indicates that PTT Express Voice client is enabled, connected to a WLAN and in a private response.
	Indicates that PTT Express Voice client is enabled and muted.
	Indicates that the PTT Express Voice client is enabled but it is not able to communicate due to a VoIP telephony call is in progress.

Enabling PTT Communication

1. Swipe up from the bottom of the Home screen and touch .
2. Slide the **Enable/Disable Switch** to the **ON** position. The button changes to an **ON** button.

Selecting a Talk Group

One of 32 Talk Groups can be selected by PTT Express users. However, only one talk group may be enabled at a time on the device. Touch one of the 32 Talk Groups. The selected Talk Group is highlighted.

PTT Communication



NOTE This section describes the default PTT Express client configuration. See the PTT Express V1.2 User Guide for detailed information on using the client.

PTT communication may be established as a Group Call. When PTT Express is enabled, the PTT button on the left side of the device is assigned for PTT communication.

Figure 75 PTT Buttons

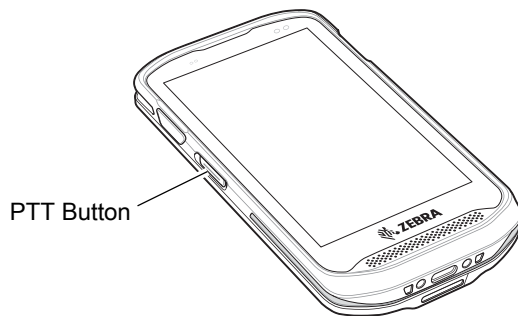

Creating a Group Call

1. Press and hold the PTT button and listen for the talk tone to play.
If a busy tone is heard, release the button and wait a moment before making another attempt. Ensure that PTT Express and the WLAN are enabled.
2. Start talking after the talk tone is heard.



NOTE If the user holds the button for more than 60 seconds (default), the call is dropped allowing others to make Group calls. The user should release the button when finished talking to allow others to make calls.

3. Release the button when finished talking.

Responding with a Private Response

The Private Response can only be initiated once a Group Call has been established. The initial Private Response is made to the originator of the Group Call.

1. Wait until an access tone is heard.
2. Within 10 seconds, double-press the PTT button, and listen for the talk tone to play.
3. If a busy tone is heard, release the button and wait a moment before making another attempt. Ensure that PTT Express and the WLAN are enabled.
4. Start talking after the talk tone plays.
5. Release the button when finished talking.

Disabling PTT Express Voice Client Communication

1. Swipe up from the bottom of the Home screen and touch .

2. Slide the **Enable/Disable Switch** to the **OFF** position. The button changes to **OFF**.
3. Touch .

RxLogger

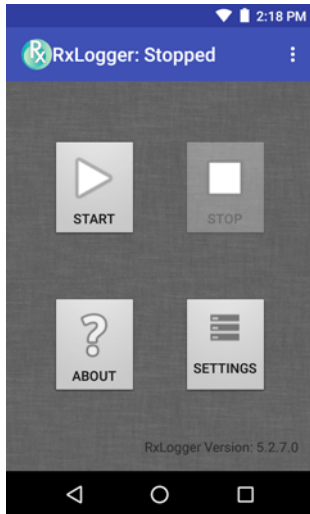

RxLogger is a comprehensive diagnostic tool that provides application and system metrics. It allows for custom plug-ins to be created and work seamlessly with this tool. RxLogger is used to diagnose device and application issues. Its information tracking includes the following: CPU load, memory load, memory snapshots, battery consumption, power states, wireless logging, cellular logging, TCP dumps, Bluetooth logging, GPS logging, logcat, FTP push/pull, ANR dumps, etc. All logs and files generated are saved onto flash storage on the device (internal or external).

Figure 76 RxLogger





Enabling Logging

To enable RxLogger:

1. Swipe up from the bottom of the Home screen and touch .
2. Touch **START**. RxLogger begins collecting data.
3. Touch .

Disabling Logging

To disable RxLogger:

1. Swipe up from the bottom of the Home screen and touch .
2. Touch **STOP**. RxLogger stops collecting data.
3. Touch .

RxLogger Utility

RxLogger Utility is a data monitoring application for viewing logs in the TC25 while RxLogger is running. The user can access the logs and RxLogger Utility features in the App View or the Overlay View.

In the App View the user views logs in the RxLogger Utility.

Figure 77 RxLogger Utility App View

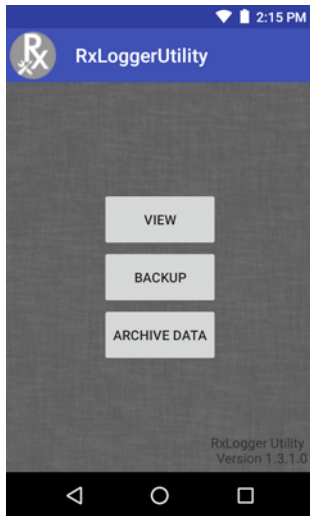

Refer to the TC25 Rugged Smartphone Integrator Guide for detailed information about using RxLogger Utility.

Diagnostic Tool

The **Diagnostic Tool** is a utility that determines the health of the TC25. Use the Diagnostic Tool to troubleshooting the device and determine issues.

1. Swipe up from the bottom of the Home screen and touch .

Figure 78 Diagnostic Tool



2. Touch **Run Test**. The app tests all enabled subsystems (by default only the Battery and System tests are enabled). See [Settings on page 94](#) to enable subsystem tests.

Figure 79 Test Passed Screen

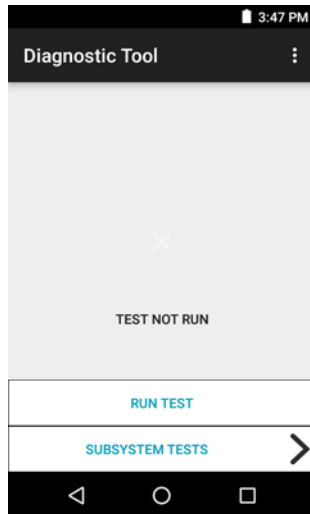
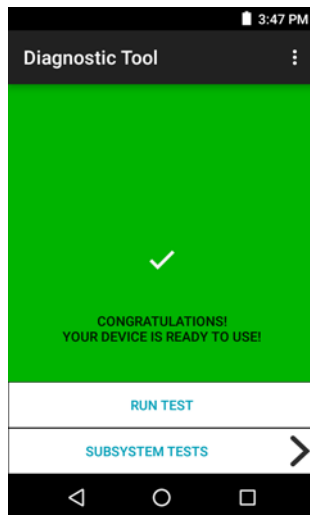
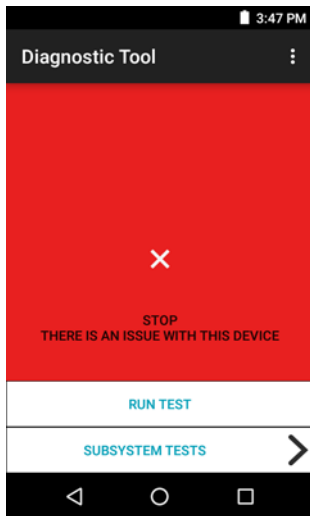

Figure 80 Test Failed Screen



3. To view each individual subsystem test, touch **Subsystem Tests**.

Figure 81 Subsystem Screen

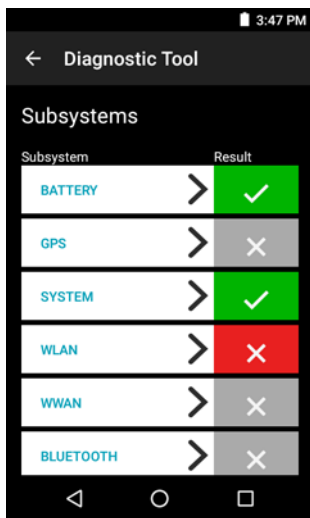



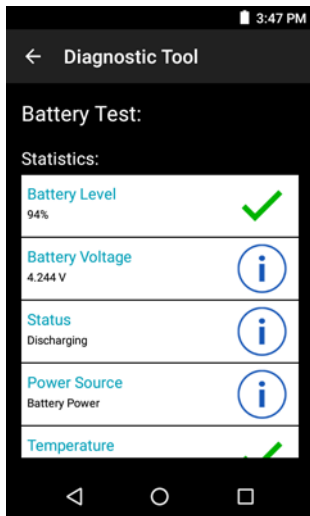

Table 12 Subsystem Test Result Indicators

Status Icon	Description
	Indicates test passed.
	Indicates test failed.
	Indicates test not supported or not enabled.

4. Touch one of the subsystems to view details.

Figure 82 Battery Subsystem Details



Settings

By default only the Battery and System tests are enabled. To enable other tests:

1. Touch **Settings**.
2. Touch to the left of the test name. A green box with a checkmark appears.
3. Touch **SAVE**.
4. Touch **Yes** to confirm.
5. Touch **Back**.

Battery Test Information

The Battery Test obtains the following information:

- **Battery Level** - Indicates the current battery charge level.
- **Battery Voltage** - Indicates the current battery voltage.
- **Status** - Indicates if the battery is charging (on AC power) or discharging (on battery power).
- **Power Source** - Indicates whether the device is receiving power from the battery or from an external source.
- **Temperature** - Indicates the current battery temperature.
- **Charge Cycles** - Not applicable.
- **Backup Battery Voltage** - Indicates backup battery voltage.
- **Manufacture Date** - Displays the manufacture date of the battery.

GPS Test Information

The GPS Test obtains the following information:

- **GPS Provider Enabled** - Indicates if GPS is enabled (true) or disabled (false).
- **Latitude** - Indicates current latitude position.
- **Longitude** - Indicates current longitude position.
- **Altitude** - Indicates current altitude in meters.

- **Bearing** - Indicates current bearing.
- **Speed** - Indicates speed in meters per second.
- **Accuracy** - Indicates GPS accuracy in meters.

System Test Information

Use the System Test to determine if the CPU or memory loads are too high, there are too many processes running on the device, or that storage on the device is almost full. The System Test obtains the following information:

- **CPU Load** - Indicates the amount of CPU being used.
- **Free Physical Memory** - Indicates the amount of RAM available.
- **Free Storage** - Indicates the amount of internal Flash memory available.
- **Process Count** - Indicates the number of processes currently running.

WLAN Test Information

If the WiFi radio is not present or disabled the test may be skipped. Use this information to determine if the device's WLAN configuration is correct or whether there is any connection with an access point or network. The WLAN Test obtains the following information:

- **WLAN Enabled** - Indicates if the WLAN radio is enabled or disabled.
- **WLAN Status** - Indicates the current status of association with the access point.
- **ESSID** - Displays the name of the wireless network.
- **BSSID** - Displays the MAC address of the connected access point.
- **MAC Address** - Displays the device's MAC address.
- **Signal** - Indicates the strength of the Wi-Fi signal (in dBm).
- **IP Address** - Displays the IP address of the device.

WWAN Test Information

The WWAN Test obtains the following information:

- **SIM State** - Displays the current state of the SIM card.
- **WAN Type** - Displays the data connection type.
- **Signal Strength** - Displays the current cellular signal strength.
- **Phone Number** - Displays the phone number assigned to the device.
- **Device ID** - Displays the device ID number.

Bluetooth Test Information

The Bluetooth Test obtains the following information:

- **Enabled** - Indicates if the Bluetooth radio is enabled or disabled.
- **Status** - Indicates if the device is paired to another Bluetooth device.
- **Connectable/Discoverable** - Indicates if the device is discoverable or connectable.
- **Address** - Displays the Bluetooth radio MAC address.
- **Name** - Displays the Bluetooth name for the device.

Data Capture

The TC25 supports data capture using:

- integrated imager
 - SE4710 scan engine
 - SE2100 scan engine
- RS507 Hands-free Imager
- RS6000 Bluetooth Ring Scanner.



IMPORTANT To determine the integrated scan engine in the device, go to **Settings > About phone > Hardware components > Scanner**.

Imaging

The TC25 with an integrated 2D imager has the following features:

- Omnidirectional reading of a variety of barcode symbologies, including the most popular linear, postal, PDF417, and 2D matrix code types.
- The ability to capture and download images to a host for a variety of imaging applications.
- Advanced intuitive laser aiming cross-hair and dot aiming for easy point-and-shoot operation.

The imager uses imaging technology to take a picture of a barcode, stores the resulting image in its memory, and executes state-of-the-art software decoding algorithms to extract the barcode data from the image.

Operational Modes

The TC25 with an integrated imager supports two modes of operation, listed below. Activate each mode by pressing the Scan button.

- **Decode Mode:** In this mode, the TC25 attempts to locate and decode enabled barcodes within its field of view. The imager remains in this mode as long as the user holds the scan button, or until it decodes a barcode.



NOTE To enable Pick List Mode, configure in DataWedge or set in an application using a API command.

- **Pick List Mode:** This mode allows the user to selectively decode a barcode when more than one barcode is in the TC25's field of view. To accomplish this, move the aiming crosshair or dot over the required

barcode to decode only this barcode. This feature is ideal for pick lists containing multiple barcodes and manufacturing or transport labels containing more than one barcode type (either 1D or 2D).

RS507 Hands-Free Imager

The RS507 Hands-free Imager is a wearable barcode scan solution for both 1D and 2D barcode symbologies.

Figure 83 RS507 Hands-Free Imager

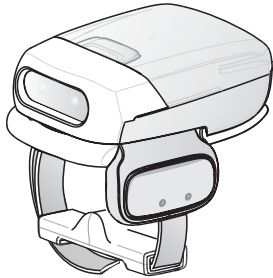

See to the RS507 Hands-free Imager Product Reference Guide for more information.

RS6000 Bluetooth Ring Scanner

The RS6000 Bluetooth Ring Scanner is a wearable barcode scan solution for both 1D and 2D barcode symbologies.

Figure 84 RS6000 Bluetooth Ring Scanner

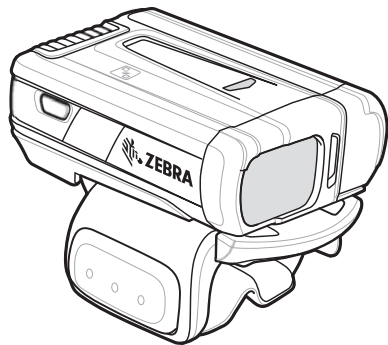

See to the RS6000 Bluetooth Ring Scanner Product Reference Guide for more information.

Scanning Considerations

Typically, scanning is a simple matter of aim, scan, and decode and a few quick trial efforts master it. However, consider the following to optimize scanning performance:

- **Range:** Any scanning device decodes well over a particular working range — minimum and maximum distances from the barcode. This range varies according to barcode density and scanning device optics. Scanning within range brings quick and constant decodes; scanning too close or too far away prevents decodes. Move the scanner closer and further away to find the right working range for the barcodes being scanned.

- Angle: Scanning angle is important for promoting quick decodes. When laser beams reflect directly back into the scanner from the barcode, this specular reflection can “blind” the scanner. To avoid this, scan the barcode so that the beam does not bounce directly back. But don’t scan at too sharp an angle; the scanner needs to collect scattered reflections from the scan to make a successful decode. Practice quickly shows what tolerances to work within.
- Hold the TC25 farther away for larger symbols
- Move the TC25 closer for symbols with bars that are close together.



NOTE Scanning procedures depend on the application and TC25 configuration. An application may use different scanning procedures from the one listed above.

Barcode Scanning with Internal SE2100 Imager

To read a barcode, a scan-enabled application is required. The TC25 contains the DataWedge application that allows the user to enable the imager, decode the barcode data and display the barcode content.

1. Ensure that an application is open on the TC25 and a text field is in focus (text cursor in text field).
2. Point the exit window on the top of the TC25 at a barcode.

Figure 85 SE2100 Imager Scanning

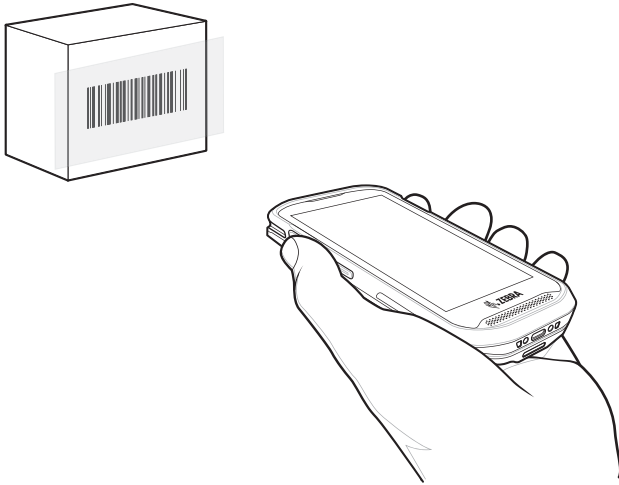

3. Press and hold the scan button.
The white aiming pattern turns on to assist in aiming.
4. Ensure the barcode is within the area formed by the aiming pattern.

Figure 86 SE2100 Aiming Pattern



5. The Data Capture LED lights green and a beep sounds, by default, to indicate the barcode was decoded successfully.
6. Release the scan button.



NOTE Imager decoding usually occurs instantaneously. The TC25 repeats the steps required to take a digital picture (image) of a poor or difficult barcode as long as the scan button remains pressed.

7. The barcode content data displays in the text field.

Barcode Scanning with Internal SE4710 Imager

To read a barcode, a scan-enabled application is required. The TC25 contains the DataWedge application that allows the user to enable the imager, decode the barcode data and display the barcode content.

1. Ensure that an application is open on the TC25 and a text field is in focus (text cursor in text field).
2. Point the exit window on the top of the TC25 at a barcode.

Figure 87 SE4710 Imager Scanning

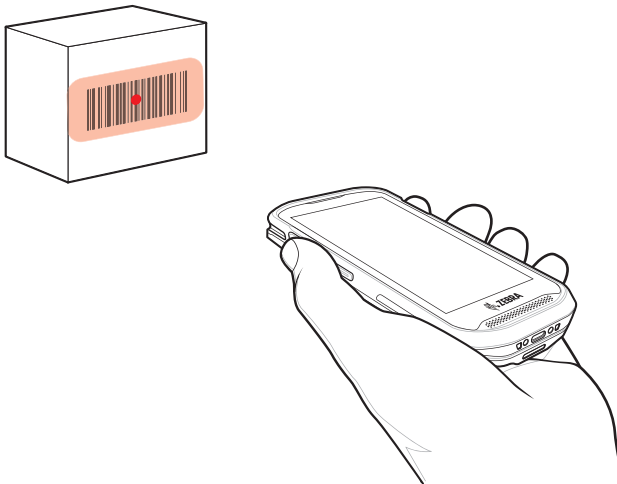

3. Press and hold the scan button.
The red LED aiming pattern turns on to assist in aiming.



NOTE When the TC25 is in Picklist mode, the imager does not decode the barcode until the crosshair or aiming dot touches the barcode.

4. Ensure the barcode is within the area formed by the aiming pattern. The aiming dot is used for increased visibility in bright lighting conditions.

Figure 88 SE4710 Aiming Pattern

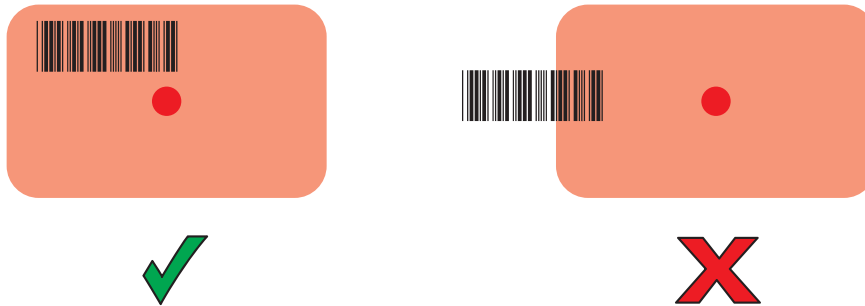
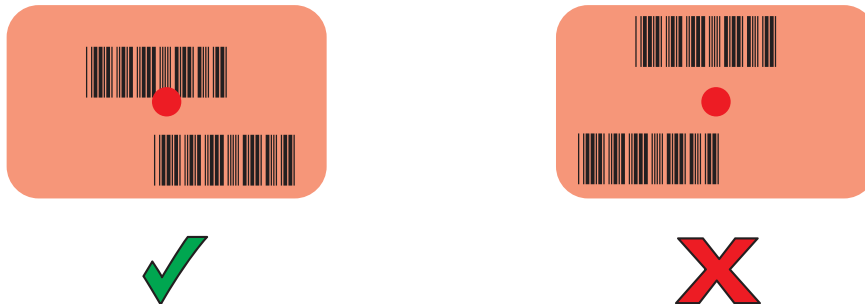

Figure 89 SE4710 Pick List Mode with Multiple barcodes in Aiming Pattern



5. The Data Capture LED lights green and a beep sounds, by default, to indicate the barcode was decoded successfully.
6. Release the scan button.



NOTE Imager decoding usually occurs instantaneously. The TC25 repeats the steps required to take a digital picture (image) of a poor or difficult barcode as long as the scan button remains pressed.

7. The barcode content data displays in the text field.

Barcode Capture with RS6000 Bluetooth Ring Scanner

To read a barcode, a scan-enabled application is required. The TC25 contains the **DataWedge** application that allows the user to enable the scanner to decode barcode data and display the barcode content. See [DataWedge Demonstration on page 83](#) for more information on launching DataWedge.

Pair the RS6000 with the TC25. See [Pairing Using Simple Serial Interface on page 103](#) or [Pairing Using Bluetooth Human Interface Device on page 103](#) for more information.

1. Ensure that an application is open on the device and a text field is in focus (text cursor in text field).
2. Point the RS6000 at a barcode.

Figure 90 Barcode Scanning with RS6000

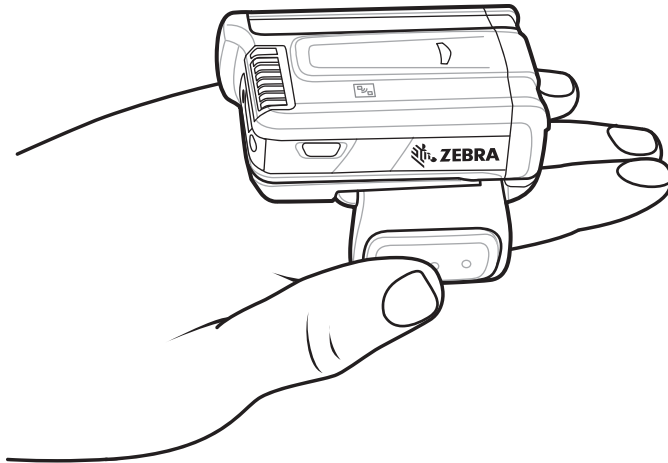

3. Press and hold the trigger.

The red laser aiming pattern turns on to assist in aiming. Ensure the barcode is within the area formed by the cross-hairs in the aiming pattern. The aiming dot is used for increased visibility in bright lighting conditions.

The RS6000 LEDs light green, a beep sounds to indicate the barcode was decoded successfully. Note that when the RS6000 is in Pick List Mode, the RS6000 does not decode the barcode until the center of the crosshair touches the barcode.

Figure 91 Aiming Pattern

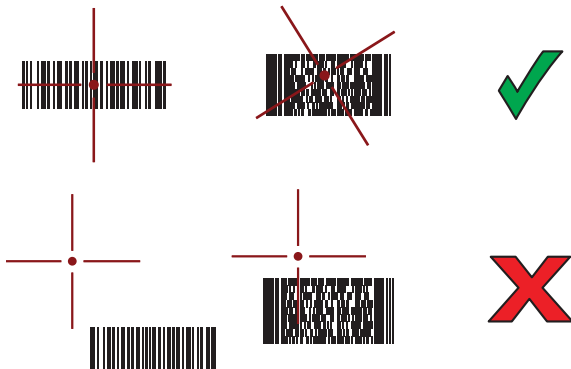

Figure 92 Pick List Mode with Multiple barcodes in Aiming Pattern



4. The captured data appears in the text field.

Barcode Capture with RS507 Hands-Free Imager

Pair the RS507 with the TC25. See [Pairing the Bluetooth Imager on page 103](#) for more information.

1. Ensure that an application is open on the device and a text field is in focus (text cursor in text field).
2. Point the RS507 at a barcode.

Figure 93 barcode Scanning with RS507

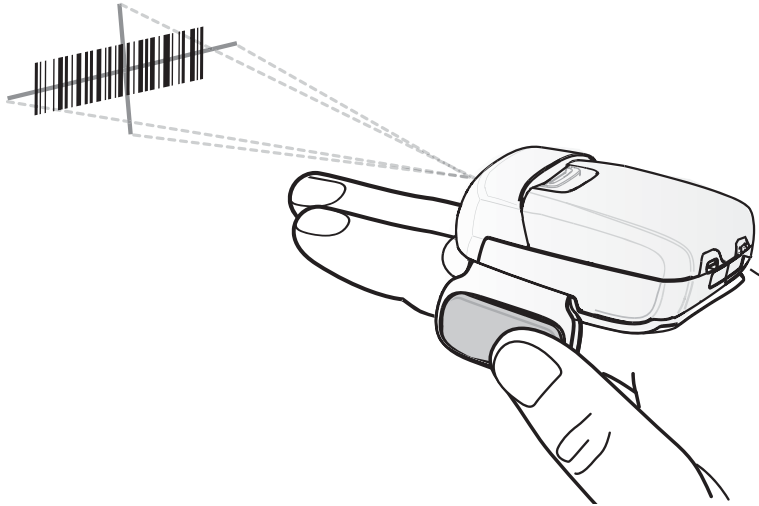

3. Press and hold the trigger.

The red laser aiming pattern turns on to assist in aiming. Ensure the barcode is within the area formed by the cross-hairs in the aiming pattern. The aiming dot is used for increased visibility in bright lighting conditions.

The RS507 LEDs light green, a beep sounds to indicate the barcode was decoded successfully. Note that when the RS507 is in Pick List Mode, the RS507 does not decode the barcode until the center of the crosshair touches the barcode.

Figure 94 Aiming Pattern

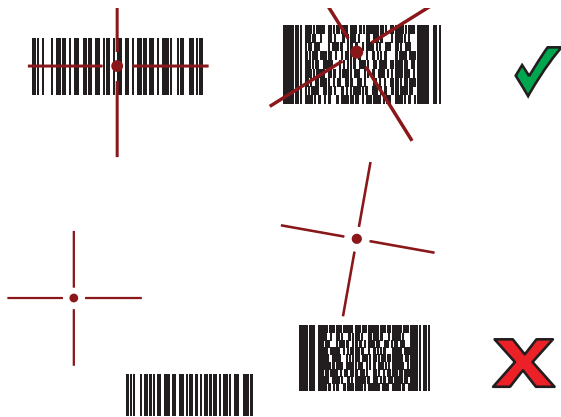

Figure 95 Pick List Mode with Multiple barcodes in Aiming Pattern



4. The captured data appears in the text field.

Pairing the Bluetooth Imager

To connect the RS507 or RS6000 imagers to the TC25, use one of the following methods:

- Simple Serial Interface (SSI)
- Bluetooth Human Interface Device (HID) Mode.

Pairing Using Simple Serial Interface

To pair the RS507/RS6000 with the TC25 using SSI:



1. Ensure that the two devices are within 10 meters (32.8 feet) of one another.
2. Install the battery into the RS507/RS6000.
3. On the TC25, swipe up from the bottom of the Home screen and touch .

Figure 96 Bluetooth Pairing Utility



4. Using the RS507/RS6000, scan the barcode on the screen.
The RS507/RS6000 emits a high/low/high/low beeps. The Scan LED flashes green indicating that the RS507/RS6000 is attempting to establish connection with the TC25. When connection is established, the Scan LED turns off and the RS507/RS6000 emits one string of low/high beeps.
5. On the TC25, touch .

Pairing Using Bluetooth Human Interface Device



To pair the RS507/RS6000 with the TC25 using HID:

1. Ensure that Bluetooth is enabled on both devices.
2. Ensure that the Bluetooth device to discover is in discoverable mode.
3. Ensure that the two devices are within 10 meters (32.8 feet) of one another.
4. Place the RS507/RS6000 in Human Interface Device (HID) mode. If the RS507/RS6000 is already in HID mode, skip to step 5.
 - a. Remove the battery from the RS507/RS6000.
 - b. Press and hold the Restore key.

- c. Install the battery onto the RS507/RS6000.
- d. Keep holding the Restore key for about five seconds until a chirp is heard and the Scan LEDs flash green.
- e. Scan the barcode below to place the RS507/RS6000 in HID mode.

Figure 97 Bluetooth HID barcode



5. Remove the battery from the RS507/RS6000.
6. Re-install the battery into the RS507/RS6000.
7. Swipe down from the status bar and then touch .
8. Touch  **Bluetooth**.
9. Touch **SCAN FOR DEVICES**. The device begins searching for discoverable Bluetooth devices in the area and displays them under **AVAILABLE DEVICES**.
10. Scroll through the list and select RS507/RS6000.



The device connects to the RS507/RS6000 and **Connected** appears below the device name. The Bluetooth device is added to the **Bluetooth devices** list and a trusted (“paired”) connection is established.

DataWedge



DataWedge is a utility that adds advanced barcode scanning capability to any application without writing code. It runs in the background and handles the interface to built-in barcode scanners. The captured barcode data is converted to keystrokes and sent to the target application as if it was typed on the keypad.

To configure DataWedge refer to the TC25 Rugged Smartphone Integrator Guide for Android Version 6.0.1.

Enabling DataWedge

1. Swipe up from the bottom of the Home screen and touch .
2. Touch .
3. Touch **Settings**.
4. Touch the **DataWedge enabled** checkbox. A blue checkmark appears in the checkbox indicating that DataWedge is enabled.
5. Touch .

Disabling DataWedge

1. Swipe up from the bottom of the Home screen and touch .
2. Touch .
3. Touch **Settings**.
4. Touch the **DataWedge enabled** checkbox. The blue checkmark disappears from the checkbox indicating that DataWedge is disabled.
5. Touch .

Wireless

This section provides information on the wireless features:

- Wireless Wide Area Network (WWAN)
- Wireless Local Area Network (WLAN)
- Bluetooth.

Wireless Wide Area Networks



NOTE Indonesian configurations do not support LTE.

Use Wireless wide area networks (WWANs) to access data over a cellular network. This section provides information on:

- Sharing a data connection
- Changing Cellular Network settings
- Locking a SIM card
- Monitoring data usage.

Sharing the Mobile Data Connection

The **tethering & portable hotspot** settings allow you to share your data connection. You can share the TC25's mobile data connection with a single computer via USB tethering or Bluetooth tethering. You can also share the data connection with up to eight devices at once, by turning it into a portable Wi-Fi hotspot. While the TC25 is sharing its data connection, an icon appears at the top of the screen and a corresponding message appears in the notification list.

USB Tethering



NOTE USB tethering is not supported on computers running Mac OS. If your computer is running Windows 7 or a recent version of Linux (such as Ubuntu), follow these instructions without any special preparation. If running a version of Windows that precedes Windows 7, or some other operating system, you may need to prepare the computer to establish a network connection via USB.

1. Connect the TC25 to a host computer with the USB cable.

An Android N icon appears at the top of the screen, and the notification **USB charging this device** appears at the top of the screen.

2. Swipe down from the status bar and then touch .
3. Touch **More**
4. Touch **Tethering & portable hotspot**.
5. Touch the **USB tethering** switch to enable.

The host computer is now sharing the TC25's data connection.

To stop sharing the data connection, touch the **USB tethering** switch again or disconnect the USB cable.

Bluetooth Tethering

Use Bluetooth tethering to share the data connection with a host computer.

Configure the host computer to obtain its network connection using Bluetooth. For more information, see the host computer's documentation.

1. Pair the TC25 with the host computer.
2. Swipe down from the status bar and then touch .
3. Touch **More**
4. Touch **Tethering & portable hotspot**.
5. Touch the **Bluetooth tethering** switch to enable.

The host computer is now sharing the TC25's data connection.

To stop sharing the data connection, touch the **Bluetooth tethering** switch again.

Portable Wi-Fi Hotspot

Configure the Wi-Fi Hotspot settings.

1. Swipe down from the status bar and then touch .
2. Touch **More**
3. Touch **Tethering & portable hotspot**.
4. Touch the **Portable Wi-Fi hotspot** switch to enable.

After a moment, the TC25 starts broadcasting its Wi-Fi network name (SSID), so you can connect to it with up to eight computers or other devices. The Hotspot  icon appears in the Status Bar.

To stop sharing the data connection, touch the **Portable Wi-Fi hotspot** switch again.

Configuring the Wi-Fi Hotspot

1. Swipe down from the status bar and then touch .
2. Touch **More**
3. Touch **Tethering & portable hotspot**.
4. Touch **Set up Wi-Fi hotspot**.

Figure 98 Set Up Wi-Fi Hotspot Dialog Box

5. In the **Network name** text field, edit the name for the hotspot.
6. Touch the **Channel** option and select a channel number from the drop-down list.
7. Touch the **Security** option and select a security method from the drop-down list.
 - **None**
 - **WPA2 PSK.**
8. In the **Password** text field, enter a password.



NOTE If **None** is selected in the **Security** option, a password is not required.

9. Touch **Save**.

Cellular Network Settings

Disabling Data When Roaming

To prevent the device from transmitting data over other carriers' mobile networks when leaving an area that is covered by the carrier's networks. This is useful for controlling expenses if the service plan does not include data roaming.

1. Swipe down from the status bar and then touch .
2. Touch **More**
3. Touch **Cellular networks**.
4. Slide the **Data roaming** switch to the on position. The **Allow data roaming?** dialog box appears.
5. Touch **OK**.

Enhanced 4G LTE Mode



NOTE Indonesian configurations do not support LTE.

Use LTE services to improve voice and other communication. (default - enabled).

Search for MicroCell

A MicroCell acts like a mini cell tower in a building or residence and connects to an existing broadband Internet service. It improves cell signal performance for voice calls, texts, and cellular data applications like picture messaging and Web surfing.





1. Swipe down from the status bar and then touch .
2. Touch **More**
3. Touch **Cellular Networks.**
4. Touch **Search for MicroCell.**

Editing the Access Point Name



NOTE Many service provider Access Point Name (APN) data are pre-configured in the device. The APN information for all other service providers must be obtained from the wireless service provider.

To use the data on a network the user must configure the APN information.

1. Swipe down from the status bar and then touch .
2. Touch **More**
3. Touch **Cellular networks.**
4. Touch **Access Point Names.**
5. Touch an APN name in the list to edit an existing APN or touch  to create a new APN.
6. Touch each APN setting and enter the appropriate data obtained from the wireless service provider.
7. When finished, touch .
8. Touch **Save.**
9. Touch the radio button next to the APN name to start using it.
10. Touch .

Locking the SIM Card

Locking the SIM card requires the user to enter a PIN every time the device is turned on. If the correct PIN is not entered, only Emergency calls can be made.





1. Swipe down from the status bar and then touch .
2. Touch  **Security.**
3. Touch **Set up SIM/RUIM card lock.**
4. Touch **Lock SIM card.**

Figure 99 Enter PIN to Lock SIM Card

5. Enter the PIN (4-8 digit) associated with the card. Touch **OK**.
6. Reset the device.

Data Usage

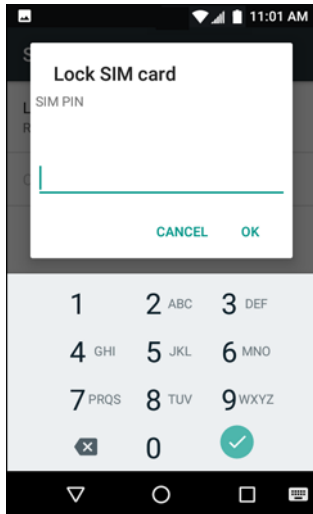
Data usage refers to the amount of data uploaded or downloaded by the TC25 during a given period. Depending on the wireless plan, you may be charged additional fees when your data usage exceeds your plan's limit. To monitor your data usage, swipe down from the status bar and then touch .



CAUTION The usage displayed on the data usage settings screen is measured by your device. Your carrier's data usage accounting may differ. Usage in excess of your carrier plan's data limits can result in steep overage charges. The feature described here can help you track your usage, but is not guaranteed to prevent additional charges.

Data usage settings allow you to:

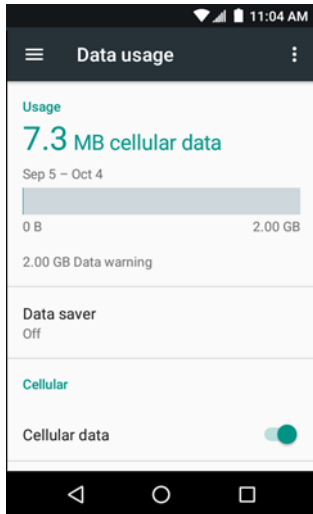

- Set the data usage level.
- Set a data usage limit.
- View or restrict data usage by app.

By default, the data usage settings screen displays the settings for mobile data.

Figure 100 Data Usage Screen

Set Data Usage Warning



To set a warning alert when the device has used a certain amount of mobile data:

1. Swipe down from the status bar and then touch .
2. Touch **Data usage**.
3. Touch **Cellular data usage** >  > **Data warning**.
4. Enter a number. To switch between megabytes (**MB**) and gigabytes (**GB**), touch the down arrow.
5. Touch **Set**.

When the usage reaches the set level, a notification appears.

Set Data Limit

To set a data usage limit:

1. Swipe down from the status bar and then touch .
2. Touch **Data usage**.
3. Touch **Cellular data usage** >  > **Set data limit**.
4. Touch **OK**.
5. Touch **Data limit**.
6. Enter a number. To switch between megabytes (**MB**) and gigabytes (**GB**), touch the down arrow.
7. Touch **Set**.

When the limit is reached, data automatically turns off and a notification appears.

Wireless Local Area Networks

Wireless local area networks (WLANs) allow the TC25 to communicate wirelessly inside a building. Before using the TC25 on a WLAN, the facility must be set up with the required hardware to run the WLAN (sometimes known as infrastructure). The infrastructure and the TC25 must both be properly configured to enable this communication.

Refer to the documentation provided with the infrastructure (access points (APs), access ports, switches, Radius servers, etc.) for instructions on how to set up the infrastructure.

Once the infrastructure is set up to enforce the chosen WLAN security scheme, use the **Wireless & networks** settings configure the TC25 to match the security scheme.

The TC25 supports the following WLAN security options:

- Open
- Wireless Equivalent Privacy (WEP).
- Wi-Fi Protected Access (WPA)/WPA2 Personal (PSK).
- Extensible Authentication Protocol (EAP).

The **Status** bar displays icons that indicate Wi-Fi network availability and Wi-Fi status. See Status Bar for more information.



NOTE Turn off Wi-Fi when not using it, to extend the life of the battery.

Scan and Connect to a Wi-Fi Network

1. Swipe down from the status bar to open the quick access panel.

Figure 101 Quick Access Panel

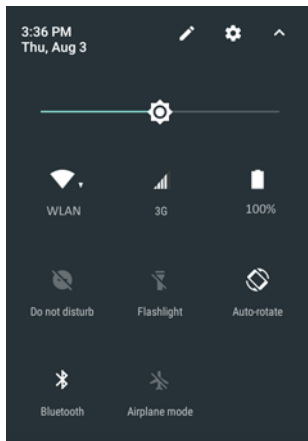

2. Touch **WLAN** to open the **WLAN** screen. The TC25 searches for WLANs in the area and lists them.

Figure 102 WLAN Screen



3. Scroll through the list and select the desired WLAN network.
4. For open networks, touch profile once or press and hold and then select **Connect to network** or for secure networks enter the required password or other credentials then touch **Connect**. See the system administrator for more information.

The TC25 obtains a network address and other required information from the network using the dynamic host configuration protocol (DHCP) protocol. To configure the TC25 with a fixed internet protocol (IP) address, Refer to the TC25 Rugged Smartphone Integrator Guide for Android Version 7.1.

5. In the Wi-Fi setting field, **Connected** appears indicating that the TC25 is connected to the WLAN.

Remove a Wi-Fi Network

To remove a remembered or connected network:

1. Swipe down from the status bar and then touch .
2. Touch  **Wi-Fi**.
3. In the **Wi-Fi** list, touch and hold the name of the network.
4. In the menu, touch **Forget network**.
5. Touch .

Bluetooth

Bluetooth-equipped devices can communicate without wires, using frequency-hopping spread spectrum (FHSS) radio frequency (RF) to transmit and receive data in the 2.4 GHz Industry Scientific and Medical (ISM) band (802.15.1). Bluetooth wireless technology is specifically designed for short-range (10 meters (32.8 feet)) communication and low power consumption.

Devices with Bluetooth capabilities can exchange information (e.g., files, appointments, and tasks) with other Bluetooth enabled devices such as printers, access points, and other mobile devices.

The TC25 support Bluetooth Low Energy. Bluetooth Low Energy is targeted at applications in the healthcare, fitness, security, and home entertainment industries. It provides reduced power consumption and cost while maintaining standard Bluetooth range.

Adaptive Frequency Hopping

Adaptive Frequency Hopping (AFH) is a method of avoiding fixed frequency interferers, and can be used with Bluetooth voice. All devices in the piconet (Bluetooth network) must be AFH-capable in order for AFH to work. There is no AFH when connecting and discovering devices. Avoid making Bluetooth connections and discoveries during critical 802.11b communications. AFH for Bluetooth consists of four main sections:

- Channel Classification - A method of detecting an interference on a channel-by-channel basis, or pre-defined channel mask.
- Link Management - Coordinates and distributes the AFH information to the rest of the Bluetooth network.
- Hop Sequence Modification - Avoids interference by selectively reducing the number of hopping channels.
- Channel Maintenance - A method for periodically re-evaluating the channels.

When AFH is enabled, the Bluetooth radio “hops around” (instead of through) the 802.11b high-rate channels. AFH coexistence allows Enterprise devices to operate in any infrastructure.

The Bluetooth radio in this device operates as a Class 2 device power class. The maximum output power is 2.5 mW and the expected range is 10 meters (32.8 ft.). A definition of ranges based on power class is difficult to obtain due to power and device differences, and whether one measures open space or closed office space.



NOTE It is not recommended to perform Bluetooth wireless technology inquiry when high rate 802.11b operation is required.

Security

The current Bluetooth specification defines security at the link level. Application-level security is not specified. This allows application developers to define security mechanisms tailored to their specific need. Link-level security occurs between devices, not users, while application-level security can be implemented on a per-user basis. The Bluetooth specification defines security algorithms and procedures required to authenticate devices, and if needed, encrypt the data flowing on the link between the devices. Device authentication is a mandatory feature of Bluetooth while link encryption is optional.

Pairing of Bluetooth devices is accomplished by creating an initialization key used to authenticate the devices and create a link key for them. Entering a common personal identification number (PIN) in the devices being paired generates the initialization key. The PIN is never sent over the air. By default, the Bluetooth stack responds with no key when a key is requested (it is up to user to respond to the key request event). Authentication of Bluetooth devices is based-upon a challenge-response transaction. Bluetooth allows for a PIN or passkey used to create other 128-bit keys used for security and encryption. The encryption key is derived from the link key used to authenticate the pairing devices. Also worthy of note is the limited range and fast frequency hopping of the Bluetooth radios that makes long-distance eavesdropping difficult.

Recommendations are:

- Perform pairing in a secure environment
- Keep PIN codes private and do not store the PIN codes in the device
- Implement application-level security.

Bluetooth Profiles

The device supports the following Bluetooth services:

- Serial Port Profile (SPP) - Allows use of RFCOMM protocol to emulate serial cable connection between two Bluetooth peer devices. For example, connecting the device to a printer.

- Object Push Profile (OPP) - Allows the device to push and pull objects to and from a push server.
- Advanced Audio Distribution Profile (A2DP) - Allows the device to stream stereo-quality audio to a wireless headset or wireless stereo speakers.
- Audio/Video Remote Control Profile (AVRCP) - Allows the device to control A/V equipment to which a user has access. It may be used in concert with A2DP.
- Personal Area Network (PAN) - Allows the use of Bluetooth Network Encapsulation Protocol to provide L3 networking capabilities over a Bluetooth link. Only PANU role is supported.
- Human Interface Device Profile (HID) - Allows Bluetooth keyboards, pointing devices, gaming devices and remote monitoring devices to connect to the device.
- Headset Profile (HSP) - Allows a hands-free device, such as a Bluetooth headset, to place and receive calls on the device.
- Hands-Free Profile (HFP) - Allows car hands-free kits to communicate with the device in the car.
- Phone Book Access Profile (PBAP) - Allows exchange of Phone Book Objects between a car kit and a mobile device to allow the car kit to display the name of the incoming caller; allow the car kit to download the phone book so the user can initiate a call from the car display.
- Symbol Serial Interface (SSI) - Allows for communication with Bluetooth Imager.
- File Transfer Profile (FTP) - Provides the capability to browse, manipulate and transfer files in file system of another system. Uses GOEP as a basis.
- Generic Attribute Profile (GATT) - Provides profile discovery and description services for Bluetooth Low Energy protocol. It defines how attributes are grouped together into sets to form services.
- HID Over GATT Profile (HOGP) - Defines the procedures and features used by Bluetooth low energy HID Devices using GATT and Bluetooth HID Hosts using GATT.
- Scan Parameters Profile (ScPP) - Provides devices with information to assist them in managing their connection idle timeout and advertising parameters to optimize for power consumption and/or reconnection latency.
- SIM Access Profile (SAP) - Allows devices such as car phones with built-in GSM transceivers to connect to a SIM card in a Bluetooth enabled device.
- Message Access Profile (MAP) - Defines the features and procedures used by devices that exchange message objects.

Bluetooth Power States

The Bluetooth radio is off by default.

- Suspend - When the TC25 goes into suspend mode, the Bluetooth radio stays on.
- Airplane Mode - When the TC25 is placed in Airplane Mode, the Bluetooth radio turns off. When Airplane mode is disabled, the Bluetooth radio returns to the prior state. When in Airplane Mode, the Bluetooth radio can be turned back on if desired.



Bluetooth Radio Power

Turn off the Bluetooth radio to save power or if entering an area with radio restrictions (e.g., an airplane). When the radio is off, other Bluetooth devices cannot see or connect to the device. Turn on the Bluetooth radio to exchange information with other Bluetooth devices (within range). Communicate only with Bluetooth radios in close proximity.





NOTE To achieve the best battery life turn off radios when not in use.

Enabling Bluetooth

1. Swipe down with two fingers from the status bar to open the quick access panel.
2. Touch  to turn Bluetooth on.
3. Touch **Done**.
4. Touch .

Disabling Bluetooth

1. Swipe down with two fingers from the status bar to open the quick access panel.
2. Touch .
3. Touch the slider switch to turn off Bluetooth.
4. Touch .





Discovering Bluetooth Device(s)

The TC25 can receive information from discovered devices without pairing. However, once paired, the TC25 and a paired device exchange information automatically when the Bluetooth radio is on. To find Bluetooth devices in the area:

1. Ensure that Bluetooth is enabled on both devices.
2. Ensure that the Bluetooth device to discover is in discoverable mode.
3. Ensure that the two devices are within 10 meters (32.8 feet) of one another.
4. Swipe down with two fingers from the status bar to open the quick access panel.
5. Touch **Bluetooth**.
6. Touch **More Settings**. The **Bluetooth** screen appears.
7. The TC25 begins searching for discoverable Bluetooth devices in the area and displays them under **Available devices**.
8. Scroll through the list and select a device. The **Bluetooth pairing request** dialog box appears.
9. Enter a PIN in the text box and touch **OK**. Enter the same PIN on the other device.
10. For Simple Pairing, touch **Pair** on both devices.
11. The Bluetooth device is added to the **Bluetooth devices** list and a trusted (“paired”) connection is established.

Changing the Bluetooth Name

By default, the TC25 has a generic Bluetooth name that is visible to other devices when connected.

1. Swipe down from the status bar and then touch .
2. Touch  **Bluetooth**.
3. If Bluetooth is not on, touch the switch to turn Bluetooth on.
4. Touch .
5. Touch **Rename this device**.
6. Enter a name and touch **Rename**.
7. Touch .



Connecting to a Bluetooth Device

Once paired, connect to a Bluetooth device.

1. Swipe down from the status bar and then touch .
2. Touch **Bluetooth**.
3. In the list, touch the unconnected Bluetooth device.
4. When connected, Connected appears below the device name.



Selecting Profiles on the Bluetooth Device

Some Bluetooth devices have multiple profiles. To select a profile:

1. Swipe down from the status bar and then touch .
2. Touch  **Bluetooth**.
3. In the **PAIRED DEVICES** list, touch  next to the device name.
4. Under **PROFILES**, check or uncheck a profile to allow the device to use that profile.
5. Touch

Unpairing a Bluetooth Device

To unpair a Bluetooth device and erase all pairing information:

1. Swipe down from the status bar and then touch .
2. Touch  **Bluetooth**.
3. In the **PAIRED DEVICES** list, touch  next to the device name.
4. Touch **Forget**.
5. Touch .

Accessories

This chapter provides information for using the accessories for the device.

Accessories

This table lists the accessories available for the TC25.

Table 13 TC25 Accessories

Accessory	Part Number	Description
Cradles		
1-Slot Base Charge Only Cradle	CRD-TC2X-BS1CO-01	Provides charging for device and Extended power pack. Requires power supply (PWR-WUA5V12W0xx), and USB-C cable.
1-Slot Ethernet Cradle	CRD-TC2X-SE1ET-01	Provides device charging and communication, and charging for Extended Power Pack. Requires power supply (PWR-BGA12V50W0WW), DC line cord (CBL-DC-388A1-01), and country-specific AC line cord.
5-Slot Charge Only Cradle	CRD-TC2X-SE5CO-01	Charges up to five devices. Requires power supply (PWR-BGA12V108W0WW), DC line cord (CBL-DC-382A1-01), and country-specific AC line cord.
Cradle Mount	BRKT-SCRD-SMRK-01	Mounts the 5-Slot Charge Only Cradle to a wall or rack.
Batteries and Chargers		
Extended Power Pack	BTRY-TC2X-PRPK1-01	Charges the TC25 internal battery to provide additional power and extend the shift time.
Vehicle Solutions		
Cigarette Light Adapter Auto Charge Cable	CHG-AUTO-USB1-01	Provides power to the device from a cigarette lighter socket.

Table 13 TC25 Accessories (Continued)

Accessory	Part Number	Description
Miscellaneous		
Trigger Handle	TRG-TC2X-SNP1-01	Adds gun-style handle with a scanner trigger for comfortable and productive scanning.
Screen Protector	KT-TC20-SCRNP1-01	Add additional screen protection.
SmartDEX Solution	DX30	Provides wireless DEX communications to the TC25.
Ethernet Bracket	BRKT-TC51-ENET1-01	Use to connect the USB/Ethernet Adapter to the 1-Slot Ethernet Cradle.
USB/Ethernet Module	MOD-MT2-EU1-01	Use with 1-Slot Ethernet Cradle to provide Ethernet connectivity.
Cradle Mating Adapter	KIT-TC2X-BS1FT-05	Use the optional mating adapter to connect two or more cradles together. Each cradle still requires a power supply (5-pack).
Carrying Solutions		
TC2X Soft Holster	SG-TC2X-HLSTR1-01	Use to hold the device on hip. Accepts TC25 device with Trigger Handle.
TC2X Hand Strap	SG-TC2X-HSTRP1-01	Replacement hand strap (3-pack).
Wrist/Arm Mount	SG-TC2X-ARMNT-01	Use to mount the TC25 to the forearm.
Small Wrist Mount Strap	SG-WT4023221-03R	Replacement small wrist mount strap
Large Wrist Mount Strap	SG-WT4023221-04R	Replacement long wrist mount strap.
Power Supplies		
Power Supply	PWR-BGA12V50W0WW	Provides power to the 1-Slot Ethernet Cradle. Requires DC Line Cord, p/n CBL-DC-388A1-01 and country specific three wire grounded AC line cord sold separately.
Power Supply	PWR-BGA12V108W0WW	Provides power to the 5-Slot Charge Only cradle. Requires DC Line Cord, p/n CBL-DC-382A1-01 and country specific three wire grounded AC line cord sold separately.
Power Supply	PWR-WUA5V12W0US	Provides 5 VDC, 2.5 A power to the USB-C cable. Includes plug adapter for use in the United States.
Power Supply	PWR-WUA5V12W0GB	Provides 5 VDC, 2.5 A power to the USB-C cable. Includes plug adapter for use in the European Union.
Power Supply	PWR-WUA5V12W0EU	Provides 5 VDC, 2.5 A power to the USB-C cable. Includes plug adapter for use in the United Kingdom.

Table 13 TC25 Accessories (Continued)

Accessory	Part Number	Description
Power Supply	PWR-WUA5V12W0AU	Provides 5 VDC, 2.5 A power to the USB-C cable. Includes plug adapter for use in Australia.
Power Supply	PWR-WUA5V12W0CN	Provides 5 VDC, 2.5 A power to the USB-C cable. Includes plug adapter for use in China.
Power Supply	PWR-WUA5V12W0BR	Provides 5 VDC, 2.5 A power to the USB-C cable. Includes plug adapter for use in Brazil.
Power Supply	PWR-WUA5V12W0KR	Provides 5 VDC, 2.5 A power to the USB-C cable. Includes plug adapter for use in Korea.
Power Supply	PWR-WUA5V12W0IN	Provides 5 VDC, 2.5 A power to the USB-C cable. Includes plug adapter for use in India.
DC Line Cord	CBL-DC-382A1-01	Provides power from the power supply (PWR-BGA12V108W0WW) to the 5-Slot Charge Only Cradle.
DC Line Cord	CBL-DC-388A1-01	Provides power from the power supply (PWR-BGA12V50W0WW) to the 1-Slot Ethernet Cradle.
2-Way DC Line Cord	CBL-DC-377A1-01	Use to charge two 5-Slot Charge only Cradles with one power supply.
2-Way DC Line Cord	CBL-DC-379A1-01	Use to charge one 1-Slot Ethernet Cradle and one 5-Slot Charge Only Cradle with one power supply.
4-Way DC Line Cord	CBL-DC-380A1-01	Use to charge four 1-Slot Ethernet Cradles with one power supply.
US AC Line Cord	23844-00-00R	7.5 feet long, grounded, three wire for power supply.
USB-C Cable	CBL-TC2X-USBC-01	The USB cable used to connect PC to single slot USB cradle.

1-Slot Base Charge Only Cradle

The 1-Slot Base Charge Only Cradle provide 5 VDC for charging:

- TC25
- Extended Power Pack
- TC25 and Extended Power Pack
- TC25 with Trigger Handle.



IMPORTANT Use only the Zebra USB-C Cable for charging.

Figure 103 1-Slot Base Charge Only Cradle

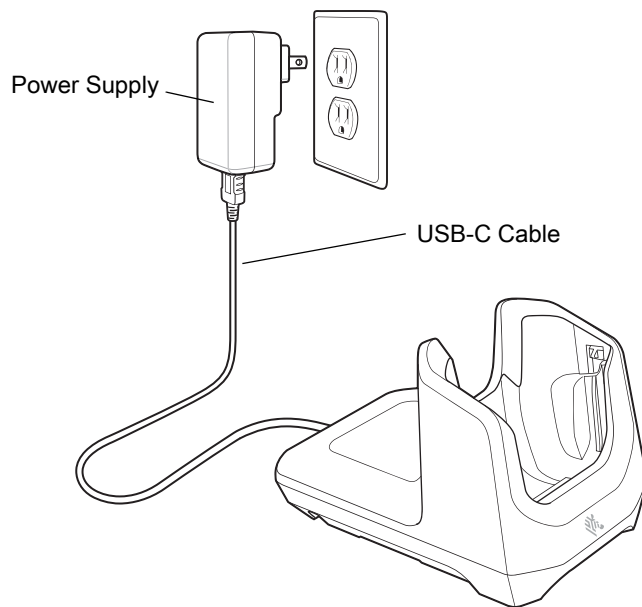

Charging the Device

To charge a device:

1. Insert the device into the slot to begin charging.

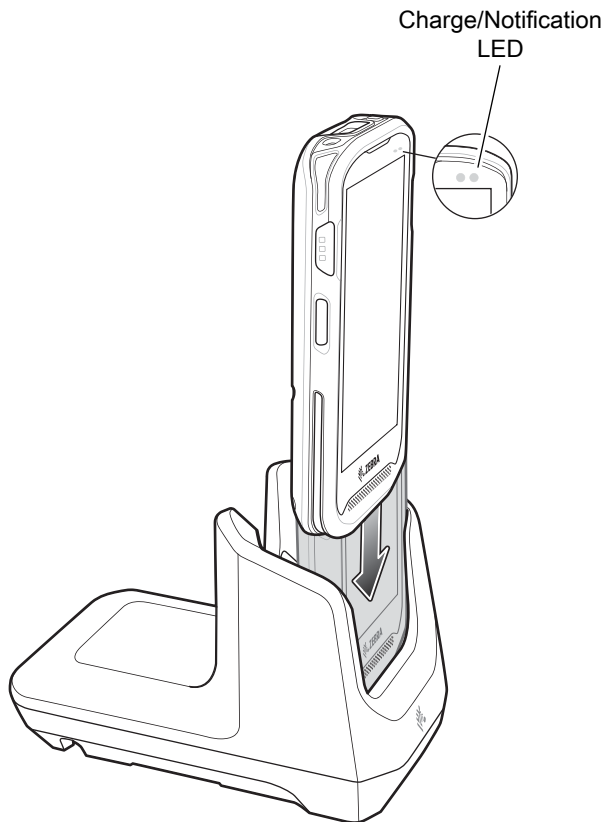
Figure 104 TC25 Charging

2. Ensure the device is seated properly.

Battery Charging

The device's Charging/Notification LED indicates the status of the battery charging in the device. See [Table 4 on page 21](#) for device charging status. The internal battery charges from fully depleted to 90% in approximately four hours and from fully depleted to 100% in approximately five hours.



NOTE In many cases the 90% charge provides plenty of charge for daily use. A full 100% charge lasts for approximately 10 hours of use.

Use only Zebra charging accessories and batteries. Charge batteries at room temperature with the TC25 in sleep mode.

Charging Temperature

Charge batteries in temperatures from 0°C to 40°C (32°F to 104°F). The device or cradle always performs battery charging in a safe and intelligent manner. At higher temperatures (e.g. approximately +37°C (+98°F)) the device or cradle may for small periods of time alternately enable and disable battery charging to keep the battery at acceptable temperatures. The device and cradle indicates when charging is disabled due to abnormal temperatures via its LED.

1-Slot Ethernet Charge Cradle

The 1-Slot Ethernet Cradle:

- Provides 5 VDC for charging:
 - TC25
 - Power Pack
 - TC25 and Power Pack
 - TC25 with Trigger Handle.
- Provides USB communication.
- Provides Ethernet and USB communication using USB/Ethernet Module.



IMPORTANT When the TC25 with attached Extended Power Pack is in the cradle, USB or Ethernet communication is disabled.

Figure 105 1-Slot Ethernet Cradle

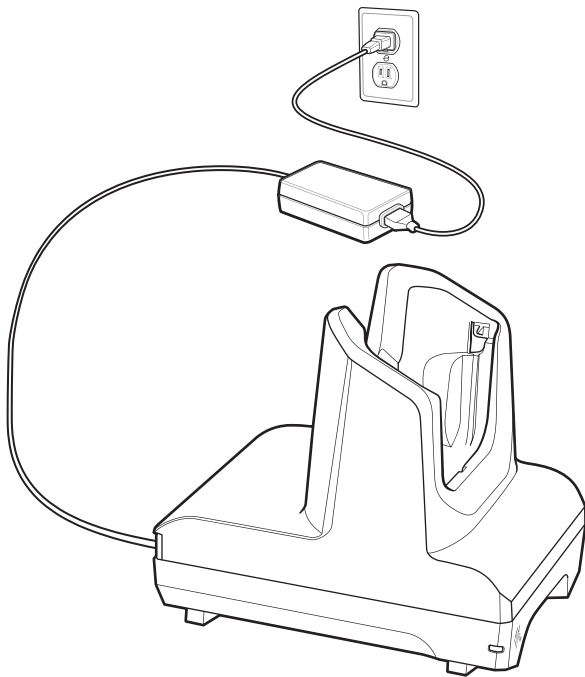

USB/Ethernet Communication

The 1-Slot Ethernet Cradle with an Ethernet Bracket and USB/Ethernet Module provides both Ethernet communication with a network and USB communication with a host computer. Prior to using the cradle for Ethernet or USB communication, ensure that the switch on the USB/Ethernet module is set properly. See the TC25 Rugged Smartphone Integrator Guide for Android Version 7.1.2 for information on setting up the Ethernet Bracket and USB/Ethernet Module.

Figure 106 1-Slot Ethernet Cradle Module Switch

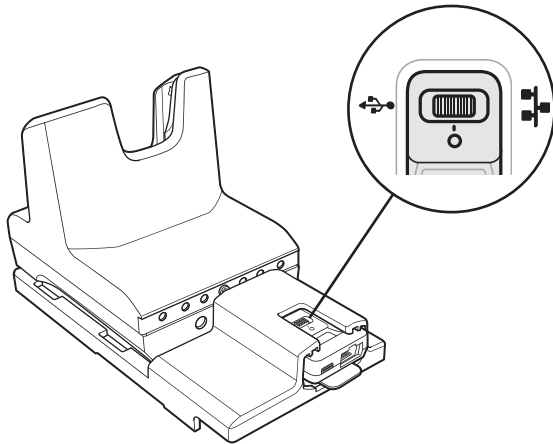

For Ethernet communication, slide the switch to the  position.

For USB communication, slide the switch to the  position.

Place the switch in the center position  to disable communications.

Ethernet LED Indicators

There are two LEDs on the USB/Ethernet Module RJ-45 connector. The green LED lights to indicate that the transfer rate is 100 Mbps. When the LED is not lit the transfer rate is 10 Mbps. The yellow LED blinks to indicate activity, or stays lit to indicate that a link is established. When it is not lit it indicates that there is no link.

Figure 107 LED Indicators

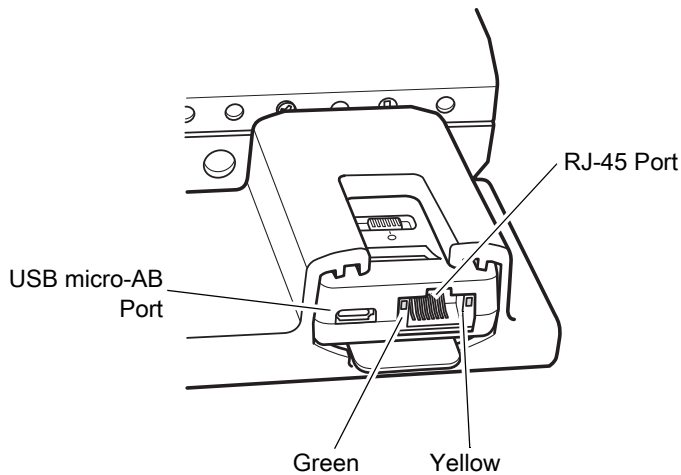



Table 14 USB/Ethernet Module LED Data Rate Indicators

Data Rate	Yellow LED	Green LED
100 Mbps	On/Blink	On
10 Mbps	On/Blink	Off

Establishing Ethernet Connection



NOTE Refer to the TC25 Integrator Guide for Android Version 7.1 for information on configuring the Ethernet settings.

1. Swipe down from the status bar and then touch .
2. Touch **Ethernet**.
3. Slide the Ethernet switch to the **ON** position.
4. Insert the device into a slot.

The  icon appears in the Status bar.

5. Touch **Eth0** to view Ethernet connection details.

Charging the Device

To charge a device:

1. Insert the device into the slot to begin charging.

Figure 108 Battery Charging

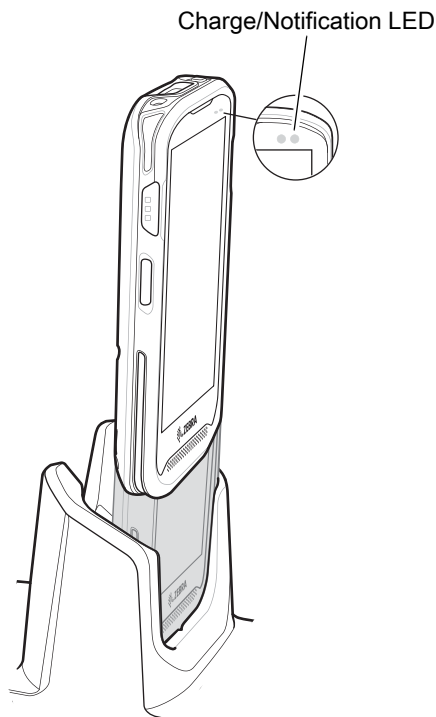

2. Ensure the device is seated properly.

Battery Charging

The device's Charging/Notification LED indicates the status of the battery charging in the device. See [Table 4 on page 21](#) for device charging status. The battery charges from fully depleted to 90% in approximately four hours and from fully depleted to 100% in approximately five hours.



NOTE In many cases the 90% charge provides plenty of charge for daily use. A full 100% charge lasts for approximately 10 hours of use.

Use only Zebra charging accessories and batteries. Charge batteries at room temperature with the TC25 in sleep mode.

Charging Temperature

Charge batteries in temperatures from 0°C to 40°C (32°F to 104°F). The device or cradle always performs battery charging in a safe and intelligent manner. At higher temperatures (e.g. approximately +37°C (+98°F)) the device or cradle may for small periods of time alternately enable and disable battery charging to keep the battery at acceptable temperatures. The device and cradle indicates when charging is disabled due to abnormal temperatures via its LED.

5-Slot Charge Only Cradle

The 5-Slot Charge Only Cradle provides 5 VDC for charging:

- TC25
- Power Pack
- TC25 and Power Pack
- TC25 with Trigger Handle.

Figure 109 5-Slot Charge Only Cradle

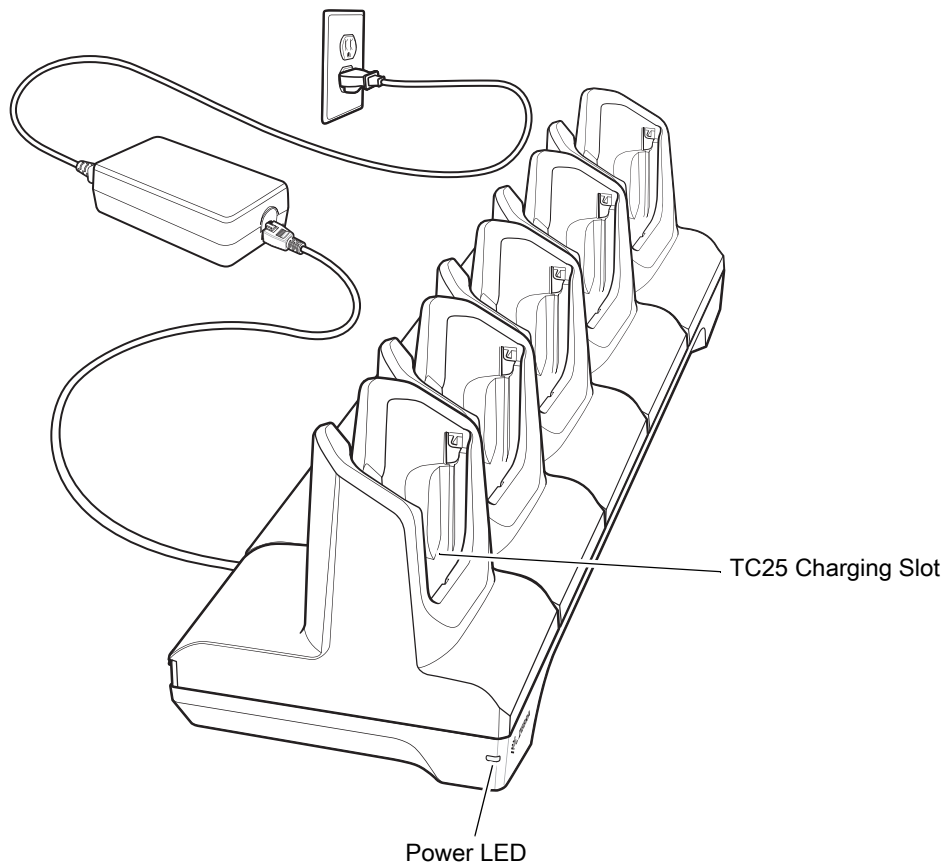

Charging the TC25

To charge a device:

1. Insert the TC25 into a slot to begin charging.

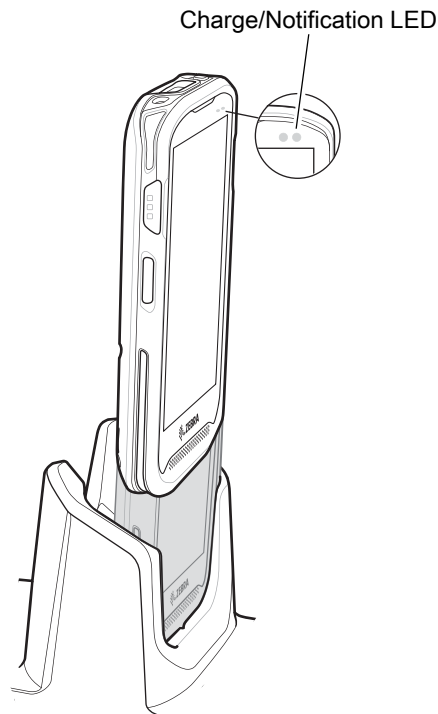
Figure 110 TC25 Charging

2. Ensure the TC25 is seated properly.

Battery Charging

The device's Charging/Notification LED indicates the status of the battery charging in the device. See [Table 4 on page 21](#) for device charging status. The battery charges from fully depleted to 90% in approximately four hours and from fully depleted to 100% in approximately five hours.



NOTE In many cases the 90% charge provides plenty of charge for daily use. A full 100% charge lasts for approximately 10 hours of use.

Use only Zebra charging accessories and batteries. Charge batteries at room temperature with the TC25 in sleep mode.

Charging Temperature

Charge batteries in temperatures from 0°C to 40°C (32°F to 104°F). The device or cradle always performs battery charging in a safe and intelligent manner. At higher temperatures (e.g. approximately +37°C (+98°F)) the device or cradle may for small periods of time alternately enable and disable battery charging to keep the battery at acceptable temperatures. The device and cradle indicates when charging is disabled due to abnormal temperatures via its LED.

Extended Power Pack

The Extended Power Pack provides additional power for charging the TC25 battery.

Figure 111 Extended Power Pack Front View

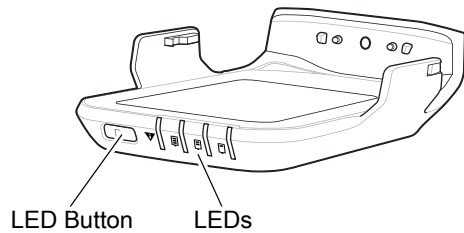
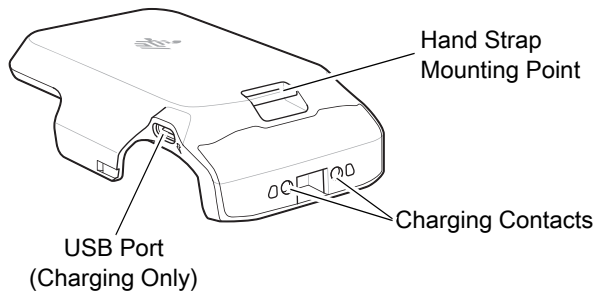

Figure 112 Extended Power Pack Back View



Installation

To install the Power Pack:

1. Align the Power Pack with the TC25.

Figure 113 Align Power Pack with TC25

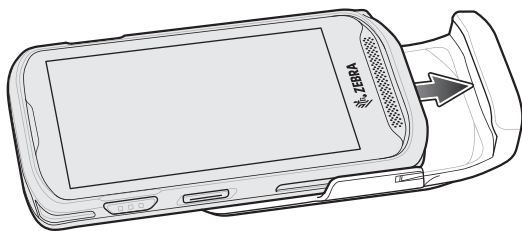

2. Slide the power pack up onto the TC25 until it snaps into place.

Charging

Charge the Extended Power Pack:

- In a cradle
- In a cradle attached to the TC25
- using a USB cable.

Figure 114 Charging Power Pack in Cradle

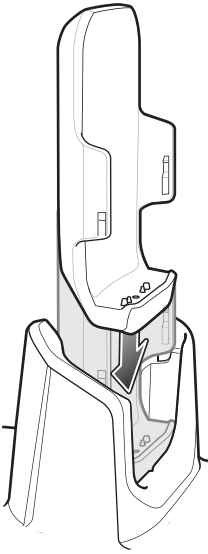
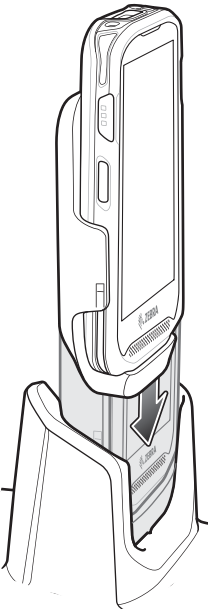
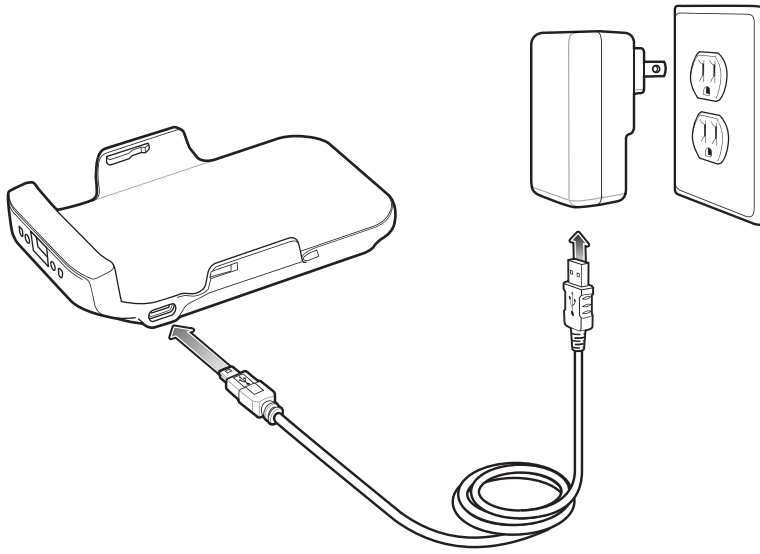

Figure 115 Charging TC25 and Power Pack in Cradle



IMPORTANT Use only the Zebra USB-C Cable for charging.

Figure 116 Charging with USB Cable



Power Pack Charging

The Power Pack Charging LEDs indicate the status of charging. See [Table 15 on page 130](#) for charging status. The power pack charges from fully depleted to 90% in approximately four hours and from fully depleted to 100% in approximately five hours.

Figure 117 Power Pack LEDs

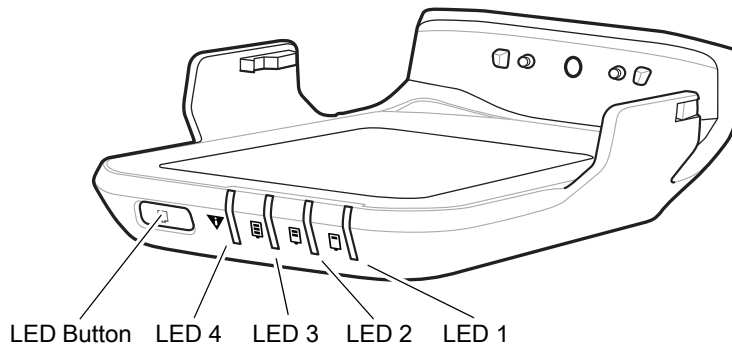













Table 15 LED Charging Indicators

LED State				Indication
LED 1	LED 2	LED 3	LED 4	
□	□	□	□	Not charging.
█ Flashing	□	□	□	Charge level is between 0% and 33%.
█ Solid	█ Flashing	□	□	Charge level is between 33% and 66%.

Table 15 LED Charging Indicators (Continued)

LED State				Indication
LED 1	LED 2	LED 3	LED 4	
 Solid	 Solid	 Flashing		Charge level is between 66% and 95%.
 Solid	 Solid	 Solid		Fully charged (95-100%).
 	 	 	 Flashing	Charging error, e.g.: <ul style="list-style-type: none"> • Temperature is too low or too high. • Charging has gone on too long without completion (typically 10 hours).

Charging Temperature

Charge batteries in temperatures from 0°C to 40°C (32°F to 104°F). The device or cradle always performs battery charging in a safe and intelligent manner. At higher temperatures (e.g. approximately +37°C (+98°F)) the device or cradle may for small periods of time alternately enable and disable battery charging to keep the battery at acceptable temperatures. The power pack indicates when charging is disabled due to abnormal temperatures via its LED.

Check Power Level

To check the power level of the power pack, press the LED button. The LEDs light indicating the charge level. After five seconds the LEDs turn off.

Figure 118 Check Power Level

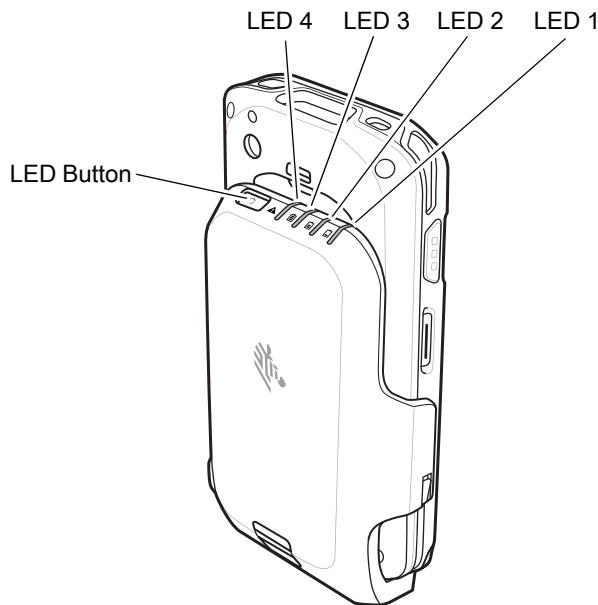





















Table 16 LED Charge State Indicators

LED State				Indication
LED 1	LED 2	LED 3	LED 4	
				No charge.
 Flashing				Charge level is between 0% and 33%.
 Solid	 Flashing			Charge level is between 33% and 66%.
 Solid	 Solid	 Flashing		Charge level is between 66% and 95%.
 Solid	 Solid	 Solid		Fully charged (95-100%).

Resetting the Extended Power Pack

If the user thinks that the pack is not operating properly, reset the pack:

Press and hold the button for 10 seconds. All four LEDs flash three times.

Trigger Handle

The Trigger Handle adds a gun-style handle with a scanning trigger to the device. It increases comfort when using the device in scan-intensive applications for extended periods of time.

Figure 119 Trigger Handle

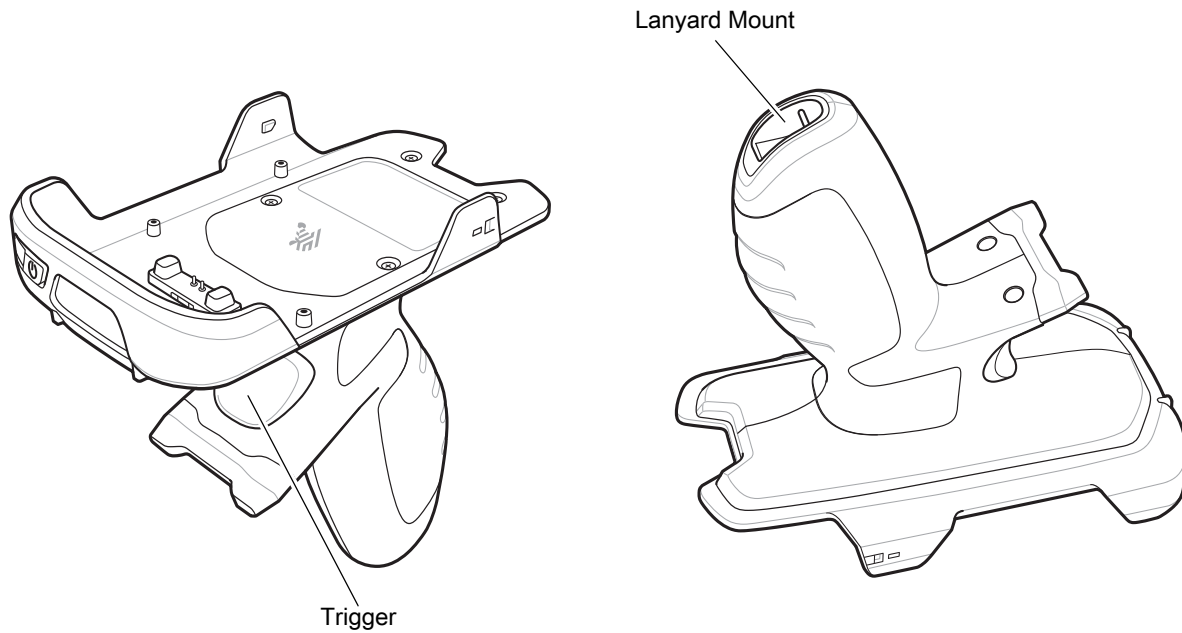

Installing the Optional Lanyard

To install the lanyard onto the Trigger Handle:

1. Insert the loop end of the tether into the slot on the bottom of the handle.
2. Feed the lanyard through the loop.

Figure 120 Install Attachment Plate to Handle



3. Pull the lanyard until the loop tightens.

Inserting the Device into the Trigger Handle

To install the device onto the Trigger handle:

1. Align and insert the top of the TC25 into the front of the Trigger Handle.

Figure 121 Insert Device into Trigger Handle

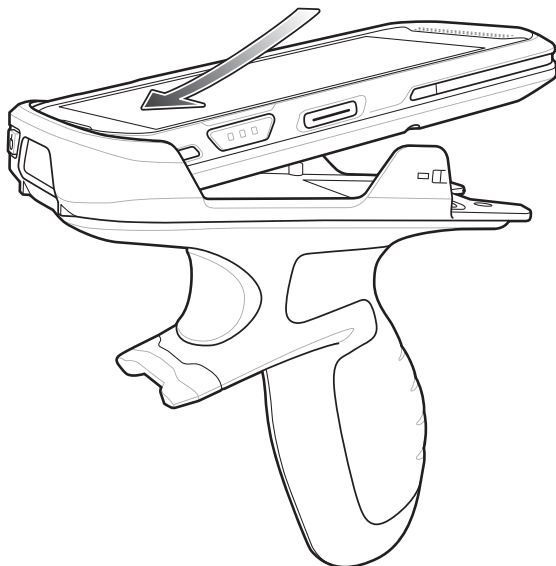

2. Rotate the device down and press down until it snaps into place.

Figure 122 Rotate Device onto Trigger Handle

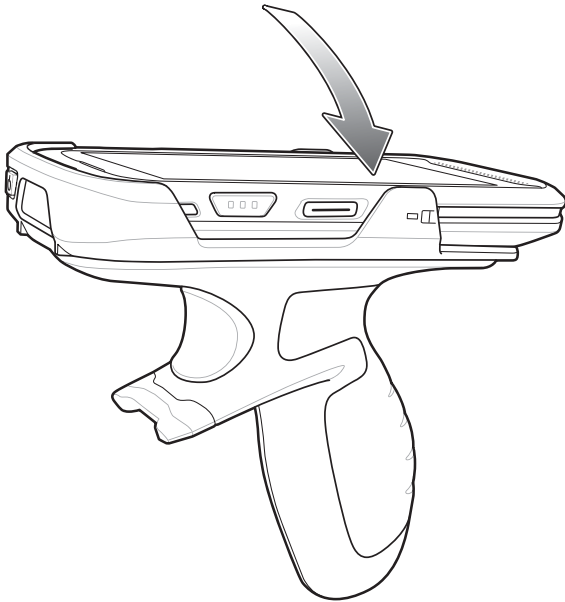

Removing the Device from the Trigger Handle

To remove the device from the Trigger Handle:

1. Using thumb, push the TC25 up.

Figure 123 Push Device Up

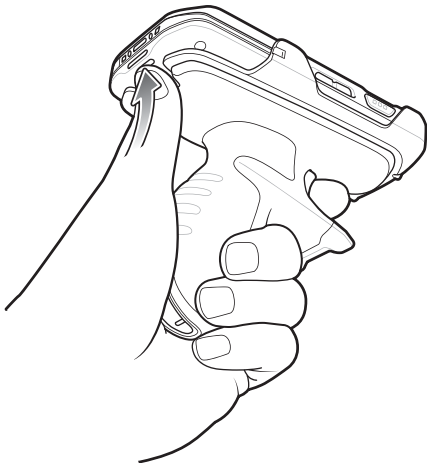

2. Slide the device away from the front of the Trigger Handle.

Figure 124 Remove Device from Trigger Handle

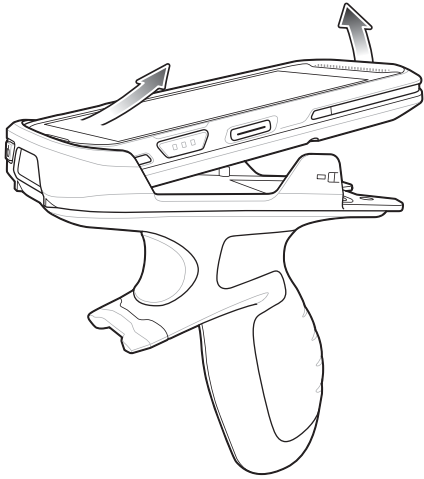

Wrist/Arm Mount

The Wrist/Arm Mount allows the user to mount the TC25 onto the forearm for hands-free applications. Install the mount on either arm with the short strap installed closest to the wrist. The user might have to remove and re-install the straps for proper installation. See [Strap Installation on page 141](#) for instructions for installing straps.

Figure 125 Wrist/Arm Mount

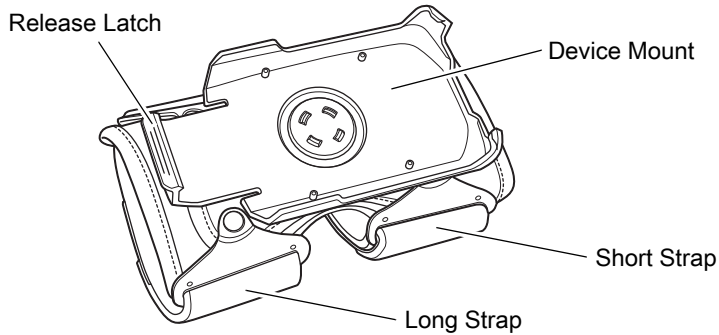

Wrist/Arm Mount Installation

To install the Wrist/Arm Mount:

1. Loosen both straps.
2. Slide the Wrist/Arm Mount onto arm with the short strap closest to the wrist.

Figure 126 Slide onto Forearm

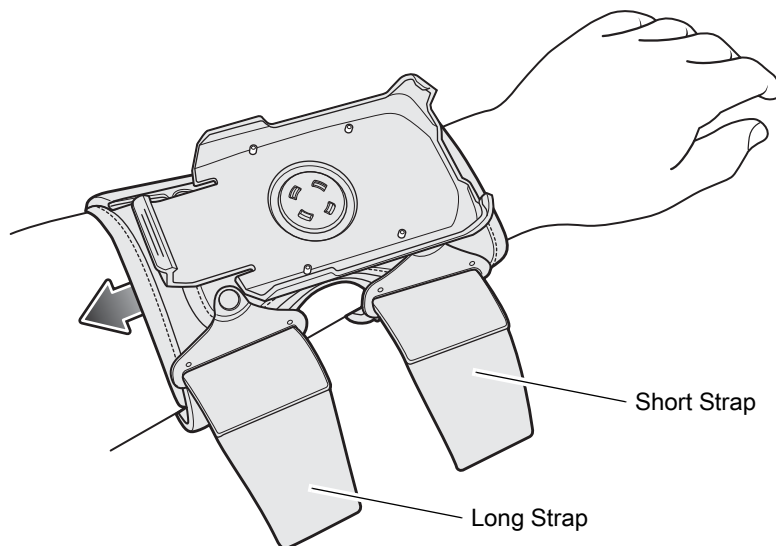

3. Tighten both straps on forearm and press hook and loop material together.

Figure 127 Tighten Straps

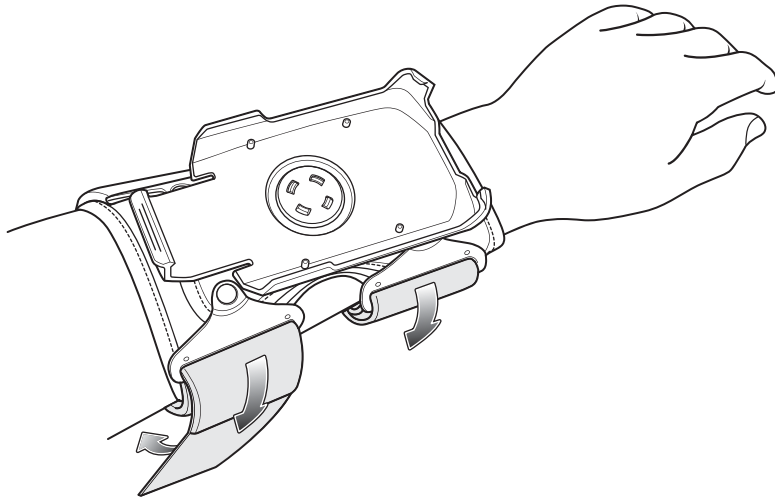

Device Installation

To install the TC25 onto the mount:

1. Insert the top of the TC25 into the end of the mount.

Figure 128 Insert TC25 in Holder

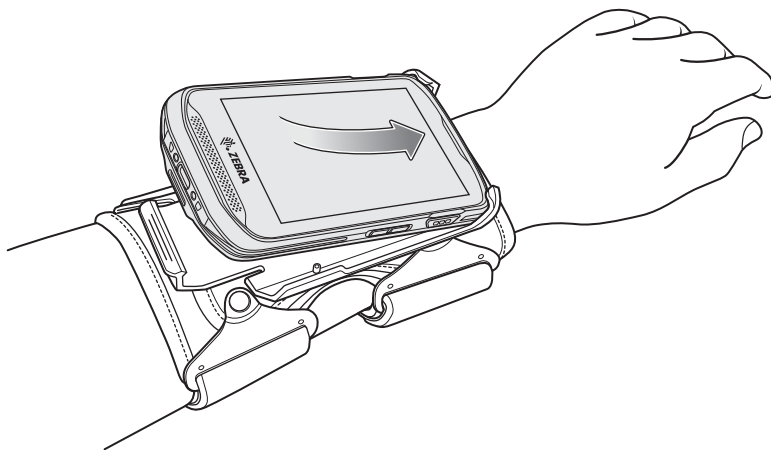

2. Rotate the bottom of the TC25 into the mount and snap into place.

Figure 129 Secure Device

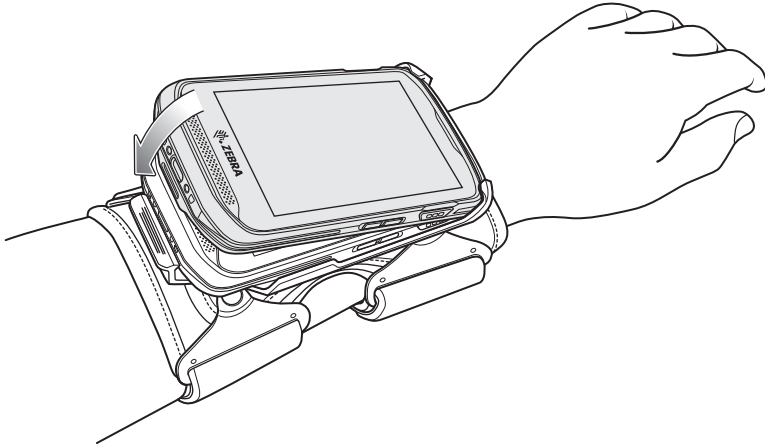

3. Rotate the TC25 for best viewing.

Figure 130 Device Rotation

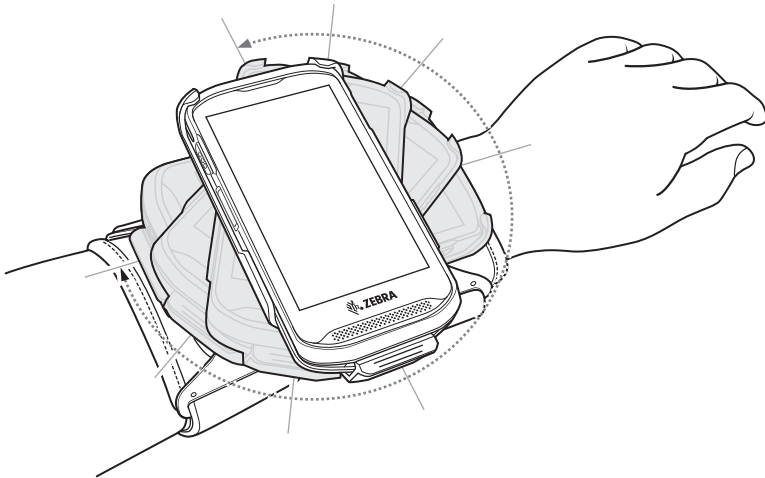

Device Removal

To remove the TC25 from the Wrist/Arm Mount:

1. Press down on the release lever.
2. Slide the TC25 out of the mount.

Figure 131 TC25 Removal

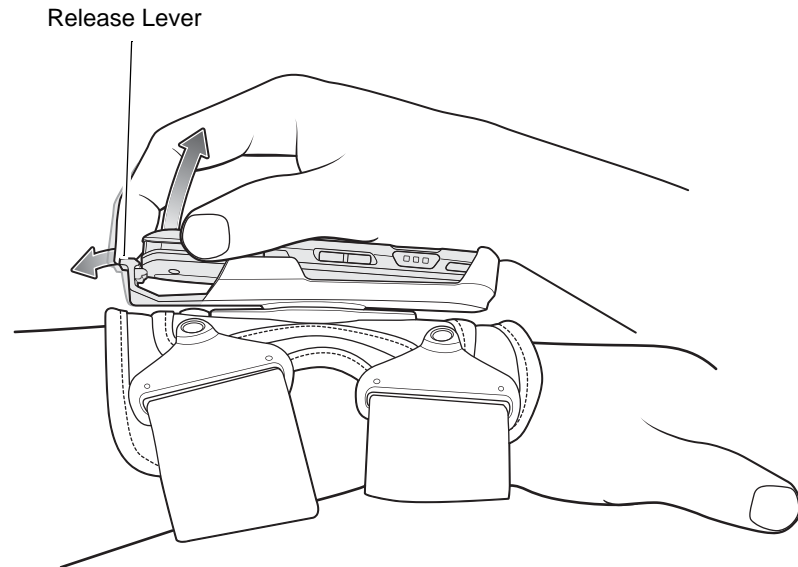

Scanning

To scan with TC25 in the wrist mount, rotate the device as shown below.

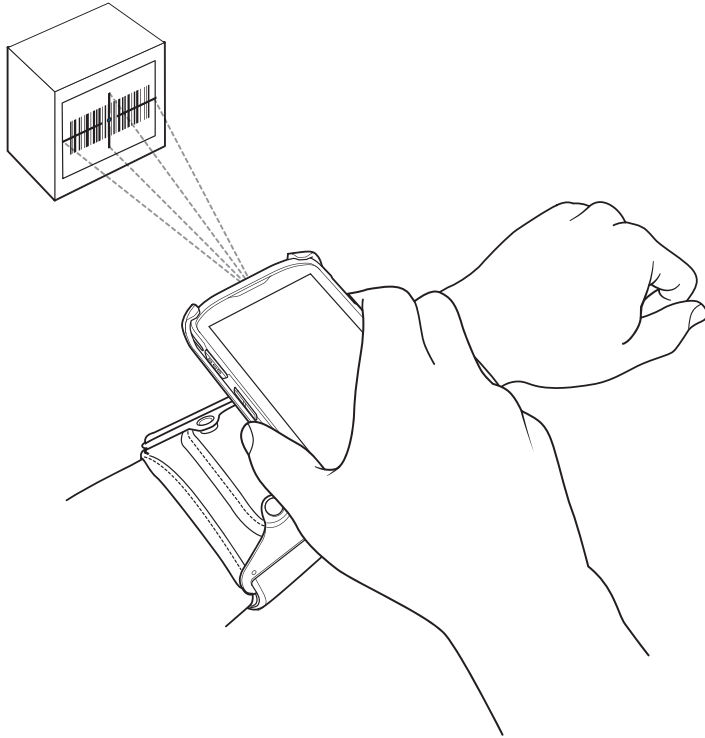
Figure 132 Scanning with Device in Wrist Mount

Strap Installation

The user can remove strap for replacement or clean and then re-install new straps.

1. Remove existing straps.
2. Feed the soft end of the strap through the slot on the rear holder with hook material positioned as shown below.

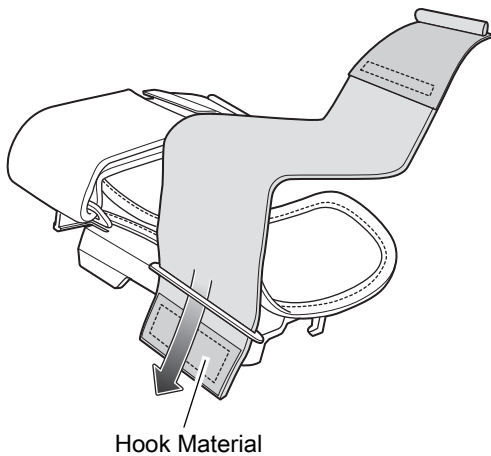
Figure 133 Feed Strap through Rear Slots

3. Fold end over and press hook and loop material together.

Figure 134 Fold End and Secure

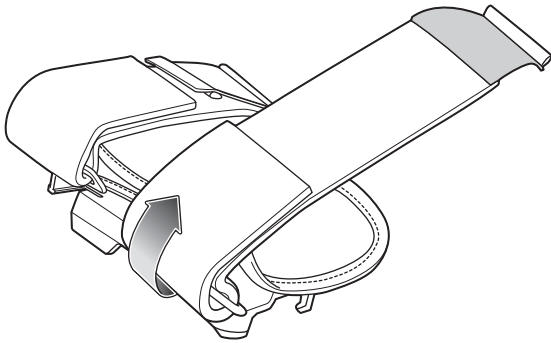

4. Feed the hard end through the slot in the front holder.

Figure 135 Feed End Through Front Slot

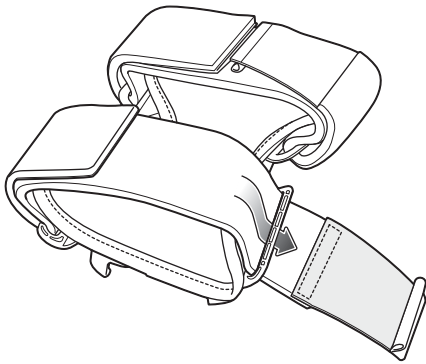

5. Fold over and press the hook and loop material together.

Figure 136 Fold End and Secure

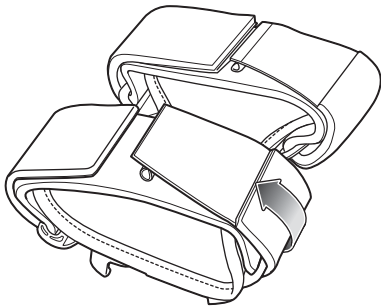

Hand Strap

The hand strap provides securing when holding the device.

To install the hand strap on the TC25:

1. Feed the top end of the hand strap through the slot at the top of the TC25.

Figure 137 Insert Hand Strap Through Top Mounting Point

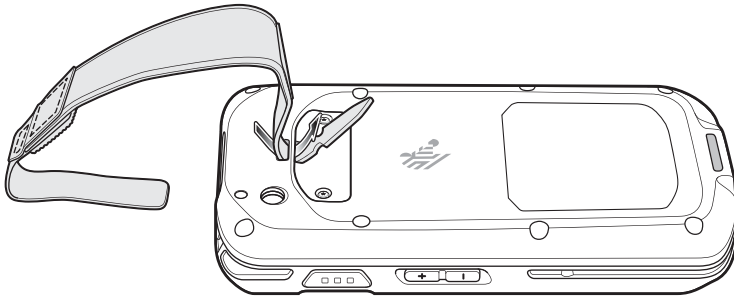

2. Pull the end through the slot.

Figure 138 Feed End Through Slot

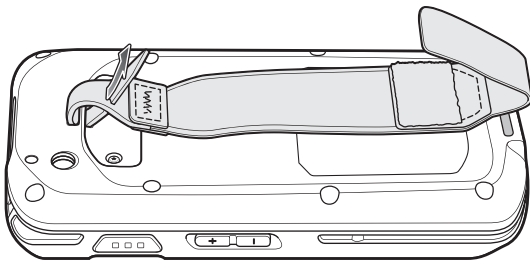

3. Insert the end of the hand strap into the slot on the hand strap.
4. Pull the end until the notch sits into the slot.
5. Feed the other end of the hand strap through the slot at the bottom of the TC25.

Figure 139 Insert Hand Strap Through Bottom Mounting Point

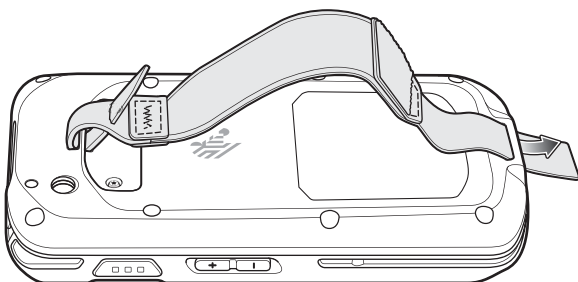

6. Pull the end through the slot.
7. Press the hook material against the loop material.

Figure 140 Adjust and Close Hand Strap End

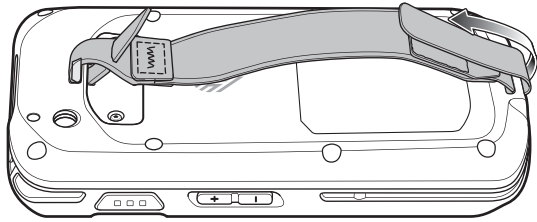

8. Place hand between device and hand strap and adjust hand strap as necessary.

To install the hand strap on the TC25 with Extended Power Pack:

1. Feed the top end of the hand strap through the slot at the top of the TC25.

Figure 141 Insert Hand Strap Through Top Mounting Point

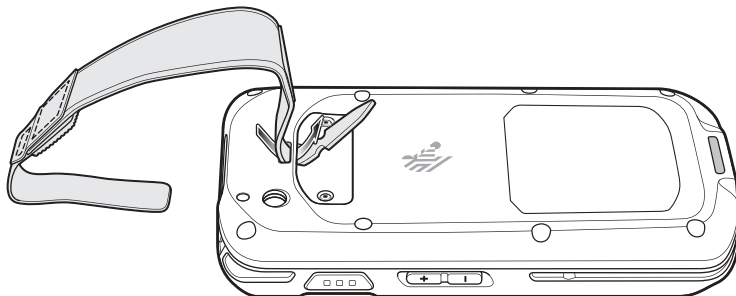

2. Pull the end through the slot.

3. Insert the end of the hand strap into the slot on the hand strap.

4. Pull the end until the notch sits into the slot.

Figure 142 Feed End Through Slot

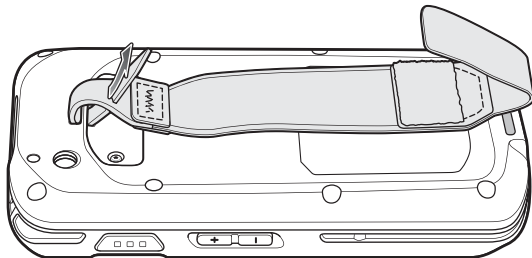

5. Feed the other end of the hand strap through the slot at the bottom of the TC25.

6. Slide the TC25 into the Extended Power Pack.

Figure 143 Insert Hand Strap Through Power Pack Bottom Mounting Point

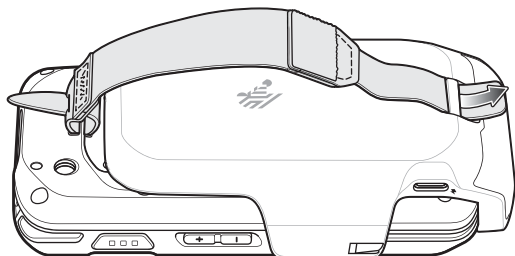

7. Pull the end through the slot.
8. Press the hook material against the loop material.

Figure 144 Adjust and Close

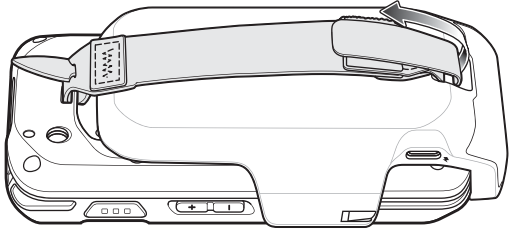

9. Place hand between device and hand strap and adjust hand strap as necessary.

Soft Holster

Use the soft holster to securely hold the device on a belt for easy access. The holster has an adjustable belt for securing the device or trigger handle.

Figure 145 Soft Holster

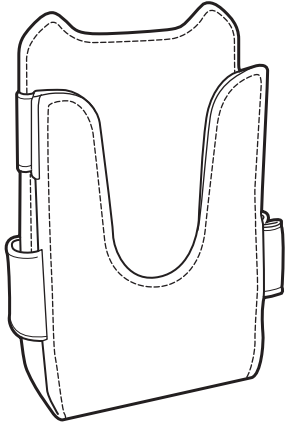

Adjusting the Holster

The holster has an adjustable belt that securely holds the device or Trigger Handle.

Figure 146 Adjust Belts

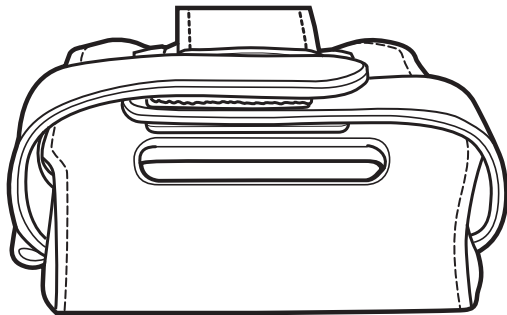

Pull Belts Tight for Device

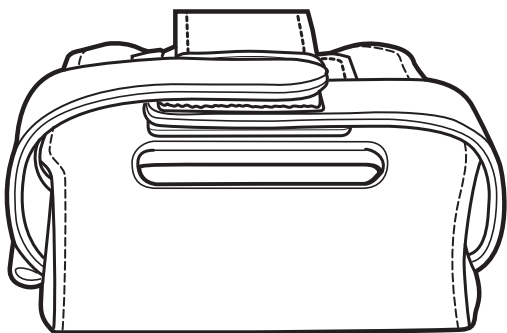

Leave Belts Loose for Trigger Handle and
Extended Power Pack

Insert the device into the holster with the device exit window facing up and the display against the body.

Figure 147 Device in Holster

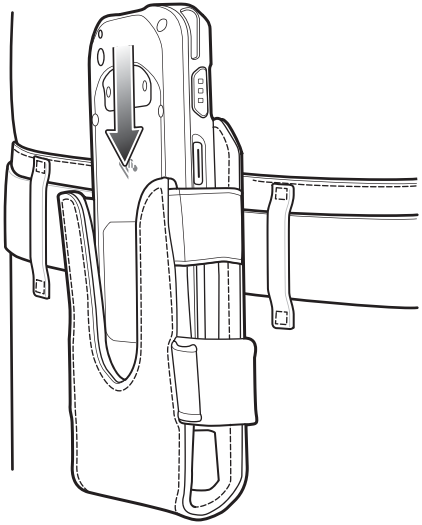

Insert the device and Extended Power Pack into the holster with the device exit window facing up and the display against the body.

Figure 148 Device with Extended power Pack in Holster

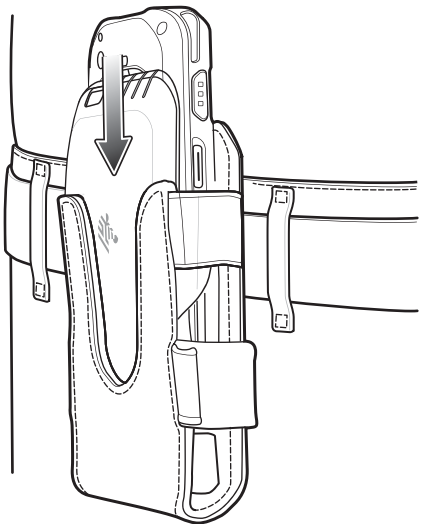

Insert the Trigger Handle into the holster with the device exit window facing down.

Figure 149 Device with Trigger Handle in Holster

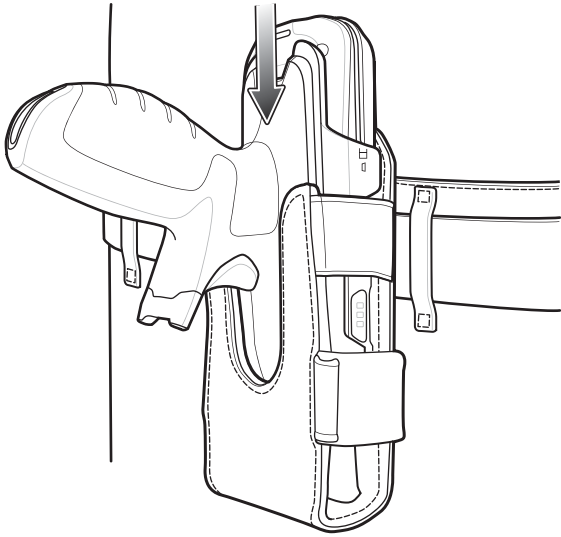

Maintenance and Troubleshooting

This chapter includes instructions on cleaning and storing the device, and provides troubleshooting solutions for potential problems during operation.

Maintaining the TC25

For trouble-free service, observe the following tips when using the TC25:

- Do not scratch the screen of the TC25. When working with the TC25 use the supplied stylus or plastic-tipped pens intended for use with a touch-sensitive screen. Never use an actual pen or pencil or other sharp object on the surface of the TC25 screen.
- The touch-sensitive screen of the TC25 is glass. Do not drop the TC25 or subject it to strong impact.
- Protect the TC25 from temperature extremes. Do not leave it on the dashboard of a car on a hot day, and keep it away from heat sources.
- Do not store or use the TC25 in any location that is dusty, damp, or wet.
- Use a soft lens cloth to clean the TC25. If the surface of the TC25 screen becomes soiled, clean it with a soft cloth moistened with a diluted window-cleaning solution.

Display Best Practices

Image Retention

Image retention may occur when a static image continuously displays for extended periods of time. A user may see a faint remnant of the image even after a new image displays. To prevent image retention:

- set the display to turn off after a few minutes of idle time.
- rotate background images on a periodic basis.
- turn off the display when the device is not in use.
- use a screen saver with the following characteristics:
 - background color set to black
 - use a small moving image (approximately 2% of the display size).
 - move the image randomly across the screen
 - screen saver should be active as long as the static image is used.

Battery Safety Guidelines

- The area in which the units are charged should be clear of debris and combustible materials or chemicals. Particular care should be taken where the device is charged in a non commercial environment.
- Follow battery usage, storage, and charging guidelines found in this guide.
- Improper battery use may result in a fire, explosion, or other hazard.
- To charge the mobile device battery, the battery and charger temperatures must be between +32°F and +104°F (0°C and +40°C)
- Do not use incompatible batteries and chargers. Use of an incompatible battery or charger may present a risk of fire, explosion, leakage, or other hazard. If you have any questions about the compatibility of a battery or a charger, contact the Global Customer Support Center.
- For devices that utilize a USB port as a charging source, the device shall only be connected to products that bear the USB-IF logo or have completed the USB-IF compliance program.
- To enable authentication of an approved battery, as required by IEEE1725 clause 10.2.1, all batteries will carry a hologram. Do not fit any battery without checking it has the authentication hologram.
- Do not disassemble or open, crush, bend or deform, puncture, or shred.
- Severe impact from dropping any battery-operated device on a hard surface could cause the battery to overheat.
- Do not short circuit a battery or allow metallic or conductive objects to contact the battery terminals.
- Do not modify or remanufacture, attempt to insert foreign objects into the battery, immerse or expose to water or other liquids, or expose to fire, explosion, or other hazard.
- Do not leave or store the equipment in or near areas that might get very hot, such as in a parked vehicle or near a radiator or other heat source. Do not place battery into a microwave oven or dryer.
- Battery usage by children should be supervised.
- Please follow local regulations to properly dispose of used re-chargeable batteries.
- Do not dispose of batteries in fire.

- In the event of a battery leak, do not allow the liquid to come in contact with the skin or eyes. If contact has been made, wash the affected area with large amounts of water and seek medical advice.
- If you suspect damage to your equipment or battery, contact the Customer Support to arrange for inspection.

Cleaning Instructions



CAUTION Always wear eye protection.

Read warning label on compressed air and alcohol product before using.

If you have to use any other solution for medical reasons please contact the Global Customer Support Center for more information.



WARNING! Avoid exposing this product to contact with hot oil or other flammable liquids. If such exposure occurs, unplug the device and clean the product immediately in accordance with these guidelines.

Approved Cleanser Active Ingredients

100% of the active ingredients in any cleaner must consist of one or some combination of the following: isopropyl alcohol, bleach/sodium hypochlorite, hydrogen peroxide or mild dish soap.

Harmful Ingredients

The following chemicals are known to damage the plastics on the device and should not come in contact with the device: ammonia solutions, compounds of amines or ammonia; acetone; ketones; ethers; aromatic and chlorinated hydrocarbons; aqueous or alcoholic alkaline solutions; ethanolamine; toluene; trichloroethylene; benzene; carbolic acid and TB-lysoform.

Cleaning Instructions

Do not apply liquid directly to the device. Dampen a soft cloth or use pre-moistened wipes. Do not wrap the device in the cloth or wipe, but gently wipe the unit. Be careful not to let liquid pool around the display window or other places. Allow the unit to air dry before use.

Special Cleaning Notes

Many vinyl gloves contain phthalate additives, which are often not recommended for medical use and are known to be harmful to the housing of the device. The device should not be handled while wearing vinyl gloves containing phthalates, or before hands are washed to remove contaminant residue after gloves are removed. If products containing any of the harmful ingredients listed above are used prior to handling the device, such as hand sanitizer that contain ethanolamine, hands must be completely dry before handling the device to prevent damage to the plastics.

Cleaning Materials Required

- Alcohol wipes
- Lens tissue
- Cotton-tipped applicators
- Isopropyl alcohol

- Can of compressed air with a tube.

Cleaning Frequency

The cleaning frequency is up to the customer's discretion due to the varied environments in which the mobile devices are used. They may be cleaned as frequently as required, but it is advisable to clean the camera window periodically when used in dirty environments to ensure optimum performance.

Cleaning the TC25

Housing

Using the alcohol wipes, wipe the housing including buttons.

Display

The display can be wiped down with the alcohol wipes, but care should be taken not to allow any pooling of liquid around the edges of the display. Immediately dry the display with a soft, non-abrasive cloth to prevent streaking.

Camera and Exit Window

Wipe the camera and exit window periodically with a lens tissue or other material suitable for cleaning optical material such as eyeglasses.

Connector Cleaning

To clean the connectors:

1. Remove the main battery from mobile computer.
2. Dip the cotton portion of the cotton-tipped applicator in isopropyl alcohol.
3. Rub the cotton portion of the cotton-tipped applicator back-and-forth across the connector. Do not leave any cotton residue on the connector.
4. Repeat at least three times.
5. Use the cotton-tipped applicator dipped in alcohol to remove any grease and dirt near the connector area.
6. Use a dry cotton-tipped applicator and repeat steps 4 through 6.



CAUTION Do not point nozzle at yourself and others, ensure the nozzle or tube is away from your face.

7. Spray compressed air on the connector area by pointing the tube/nozzle about ½ inch away from the surface.
8. Inspect the area for any grease or dirt, repeat if required.

Cleaning Cradle Connectors

To clean the connectors on a cradle:

1. Remove the DC power cable from the cradle.
2. Dip the cotton portion of the cotton-tipped applicator in isopropyl alcohol.

3. Rub the cotton portion of the cotton-tipped applicator along the pins of the connector. Slowly move the applicator back-and-forth from one side of the connector to the other. Do not leave any cotton residue on the connector.
4. All sides of the connector should also be rubbed with the cotton-tipped applicator.



CAUTION Do not point nozzle at yourself and others, ensure the nozzle or tube is pointed away from your face.

5. Spray compressed air in the connector area by pointing the tube/nozzle about ½ inch away from the surface.
6. Remove any lint left by the cotton-tipped applicator.
7. If grease and other dirt can be found on other areas of the cradle, use a lint-free cloth and alcohol to remove.
8. Allow at least 10 to 30 minutes (depending on ambient temperature and humidity) for the alcohol to air dry before applying power to cradle.

If the temperature is low and humidity is high, longer drying time is required. Warm temperature and dry humidity requires less drying time.

Troubleshooting

The following tables provides typical problems that might arise and the solution for correcting the problem.

TC25

Table 17 Troubleshooting the TC25

Problem	Cause	Solution
When pressing the power button the TC25 does not turn on.	Battery not charged.	Charge or replace the battery in the TC25.
	System crash.	Perform a reset.
When pressing the power button the TC25 does not turn on but two LEDs blink.	Battery charge is at a level where data is maintained but battery should be re-charged.	Charge the battery in the TC25.
Battery did not charge.	Battery failed.	Contact system administrator.
	TC25 removed from cradle while battery was charging.	Insert TC25 in cradle. See Charging the Battery on page 19 .
	Extreme battery temperature.	Battery does not charge if ambient temperature is below 0°C (32°F) or above 40°C (104°F).
Cannot see characters on display.	TC25 not powered on.	Press the Power button.
During data communication with a host computer, no data transmitted, or transmitted data was incomplete.	TC25 removed from cradle or disconnected from host computer during communication.	Replace the TC25 in the cradle, or reattach the communication cable and re-transmit.
	Incorrect cable configuration.	See the system administrator.
	Communication software was incorrectly installed or configured.	Perform setup.
During data communication over Wi-Fi, no data transmitted, or transmitted data was incomplete.	Wi-Fi radio is not on.	Turn on the Wi-Fi radio.
	You moved out of range of an access point.	Move closer to an access point.

Table 17 Troubleshooting the TC25 (Continued)



Problem	Cause	Solution
During data communication over Bluetooth, no data transmitted, or transmitted data was incomplete.	Bluetooth radio is not on.	Turn on the Bluetooth radio.
	You moved out of range of another Bluetooth device.	Move within 10 meters (32.8 feet) of the other device.
No sound.	Volume setting is low or turned off.	Adjust the volume.
TC25 shuts off.	TC25 is inactive.	The display turns off after a period of inactivity. Set this period to 15 seconds, 30 seconds, 1, 2, 5, 10 or 30 minutes.
	Battery is depleted.	Replace the battery.
Tapping the window buttons or icons does not activate the corresponding feature.	The device is not responding.	Reset the device.
A message appears stating that the TC25 memory is full.	Too many files stored on the TC25.	Delete unused memos and records. If necessary, save these records on the host computer (or use an SD card for additional memory).
	Too many applications installed on the TC25.	Remove user-installed applications on the TC25 to recover memory. Select  >  Apps > Downloaded . Select the unused program and tap Remove .
The TC25 does not decode with reading barcode.	Scanning application is not loaded.	Load a scanning application on the TC25 or enable DataWedge. See the system administrator.
	Unreadable barcode.	Ensure the symbol is not defaced.
	Distance between exit window and barcode is incorrect.	Place the TC25 within proper scanning range.
	TC25 is not programmed for the barcode.	Program the TC25 to accept the type of barcode being scanned. Refer to the EMDK or DataWedge application.
	TC25 is not programmed to generate a beep.	If the TC25 does not beep on a good decode, set the application to generate a beep on good decode.
	Battery is low.	If the scanner stops emitting a laser beam upon a trigger press, check the battery level. When the battery is low, the scanner shuts off before the TC25 low battery condition notification. Note: If the scanner is still not reading symbols, contact the distributor or the Global Customer Support Center.

Table 17 Troubleshooting the TC25 (Continued)

Problem	Cause	Solution
TC25 cannot find any Bluetooth devices nearby.	Too far from other Bluetooth devices.	Move closer to the other Bluetooth device(s), within a range of 10 meters (32.8 feet).
	The Bluetooth device(s) nearby are not turned on.	Turn on the Bluetooth device(s) to find.
	The Bluetooth device(s) are not in discoverable mode.	Set the Bluetooth device(s) to discoverable mode. If needed, refer to the device's user documentation for help.
Cannot unlock TC25.	User enters incorrect password.	<p>If the user enters an incorrect password eight times, the user is requested to enter a code before trying again.</p> <p>If the user forgot the password, contact system administrator.</p>

Technical Specifications

The following sections provide technical specification for the device.

TC25

Table 18 TC25 Technical Specifications

Item	Description
Physical Characteristics	
Dimensions	Length: 134.0 mm (5.3 in.) Width: 71.3 mm (2.8 in.) Depth: 17.9 mm (0.7 in.)
Weight	200 g (7.1 oz)
Display	4.3 in. High Definition (800 x 480) WVGA; exceptionally bright, outdoor viewable; optically bonded to touch panel
Touch Panel	Dual mode capacitive touch with stylus or bare or gloved fingertip input (conductive stylus sold separately); Corning Gorilla Glass 4
Backlight	Light Emitting Diode (LED) backlight
Internal Battery	Rechargeable 3,000 mAh (typical) / 2,900 mAh (minimum) Li-Ion, Power Precision+; Improved battery technology for longer cycle times and real-time visibility into battery metrics for better battery management; Fast charging (2.4 mA)
Expansion Slot	User accessible microSD up to 32 GB SDHC formatted in FAT32.
Connection Interface	Universal Serial Bus (USB) 2.0 High Speed (host and client)
Notification	Audible tone; multi-color LEDs, vibration
Voice and Audio	Two microphones support with noise cancellation; vibrate alert; speaker; Bluetooth wireless headset support. High quality speaker phone; Cellular circuit switch voice; HD Voice
Performance Characteristics	
CPU	APQ8037 64-bit, 8-core, ARM Cortex A53 power-optimization

Specifications

Table 18 TC25 Technical Specifications (Continued)

Item	Description
Operating System	Android 7.1 Nougat
Memory	2 GB RAM/16 GB Flash or 2 GB RAM/32 GB Flash
Output Power	USB 5 VDC @ 500 mA max
User Environment	
Operating Temperature	-10°C to 50°C (14°F to 122°F)
Storage Temperature	-40°C to 70°C (-40°F to 158°F)
Charging Temperature	0° C to 40° C (32°F to 104°F)
Relative Humidity	Operating: 5 to 95% non-condensing
Drop Specification	Multiple 1.2 m (4 ft.) to tile over concrete over operating temperature range.
Tumble	500 0.5 m (1.6 ft.) tumbles; meets and exceeds IEC tumble specifications
Electrostatic Discharge (ESD)	+/-15 kVDC air discharge, +/-10 kVDC direct discharge, +/- 10 kVDC indirect discharge
Vibration	4 g's PK Sine (5 Hz to 2 kHz); 0.04g2/Hz Random (20 Hz to 2 kHz); 60 minute duration per axis, 3 axis
Thermal Shock	-40°C to 70°C (-40°F to 158°F) rapid transition
Interactive Sensor Technology (IST)	
Motion Sensor	3-axis accelerometer Gyro; 3-axis accelerometer
Light Sensor	Ambient light sensor to auto adjust display backlight brightness
Proximity Sensor	Automatically detects when the user places the handset against head during a phone call to disable display output and touch input.
Wireless LAN Data and Voice Communications	
Radio	IEEE 802.11 a/b/g/n/ac/d/r/k/w/v/h/i IPv4, IPv6
Data Rates Supported	5GHz: 802.11a/n/ac - up to 433.3 Mbps 2.4GHz: 802.11b/g/n - up to 150 Mbps
Operating Channels	2.4 GHz: Chan 1 - 13; 1 - 11 (US) 5 GHz: Chan 36 - 48, 52 - 64, 100 - 140, 149 - 151, 161 - 165 Channel Bandwidth: 20, 40, 80 MHz Actual operating channels/frequencies and bandwidth depend on regulatory rules and certification agency.
Security and Encryption	WEP (40 or 104 bit); WPA/WPA2 Personal (TKIP and AES); WPA/WPA2 Enterprise (TKIP and AES) — EAP-TTLS (PAP, MSCHAP, MSCHAPv2), EAP-TLS, PEAPv0-MSCHAPv2, PEAPv1-EAP-GTC and LEAP
Certifications	802.11 a/b/g/n/ac; WPA; WPA2
Fast Roam	802.11

Specifications

Table 18 TC25 Technical Specifications (Continued)

Item	Description
Wireless WAN Data and Voice Communications	
Frequency band	Worldwide: LTE: 700/800/900/1800/2100/2600 (FDD 28,20,8,3,1,7); UMTS/HSPA/HSPA+: 850/900/2100; GSM/GPRS/EDGE: 850/900/1800/1900 Note: Indonesian configurations do not support LTE. Americas: LTE: 700/850/1800/1900, (FDD 12,17,5,2,4); UMTS/HSPA/HSPA+: 850/1700/1900 GSM/GPRS/EDGE: 850/900/1800/1900
GPS	Integrated, Autonomous, Assisted GPS (A-GPS), GLONASS, Beidou
Wireless PAN Data and Voice Communications	
Bluetooth	Class 2, Bluetooth v4.1 (Bluetooth Smart technology); Bluetooth Wideband support HFPv1.6; Bluetooth v4.1 Low Energy (LE)
Data Capture Specifications	
2D Imager	SE2100 imager (1D and 2D) with LED aimer. SE4710 imager (1D and 2D) with LED aimer.
Camera	Rear - 8 MP autofocus; f/2.4 aperture; rear camera flash LED generates balanced white light; supports Torch mode.
2D Imager Engine (SE2100) Specifications	
Field of View	Horizontal - 41.5° Vertical - 31.7°
Image Resolution	640 horizontal X 480 vertical pixels
Roll	360°
Pitch Angle	± 60° from normal
Skew Tolerance	± 60° from normal
Ambient Light	Sunlight: 10,000 ft. candles (107,639 lux)
Focal Distance	From front of engine: 10.7 cm (4.2 in.)
Illumination System	LED: Ultra white Pattern Angle: 80° at 505 intensity
2D Imager Engine (SE4710) Specifications	
Field of View	Horizontal - 48.0° Vertical - 36.7°
Image Resolution	1280 horizontal X 960 vertical pixels
Roll	360°

Specifications

Table 18 TC25 Technical Specifications (Continued)

Item	Description
Pitch Angle	± 60° from normal
Skew Tolerance	± 60° from normal
Ambient Light	Sunlight: 10,000 ft. candles (107,639 lux)
Focal Distance	From front of engine: 17.7 cm (7.0 in.)
Laser Aiming Element	Visible Laser Diode (VLD): 655 nm ± 10 nm Central Dot Optical Power: 0.6 mW (typical) Pattern Angle: 48.0° horizontal, 38.0° vertical
Illumination System	LEDs: Warm white LED Pattern Angle: 80° at 505 intensity

Table 19 Data Capture Supported Symbologies

Item	Description
1D Barcodes	Code 128, EAN-8, EAN-13, GS1 DataBar Expanded, GS1 128, GS1 DataBar Coupon, UPCA, Interleaved 2 of 5, UPC Coupon Code
2D Barcodes	PDF-417, QR Code

Index

Numerics

5-slot charge only cradle kit 117

A

adaptive frequency hopping 113
adjust volume 56
airplane mode 28
albums 79
applications 47
approved cleanser 151
arm mount 118
audio modes 56

B

battery
 low power notification 27
 management 26
 optimization 27
 usage monitoring 26
battery charging 19
battery usage 26
Bluetooth 105, 112
 PIN 113
 power states 114
 profiles 113
 security 113
bluetooth 112
Bluetooth headset 56
bullets 11

C

calculator 47
camera 15, 47, 73
camera settings 75
cleaning 151
cleaning instructions 151
clock 47
conference call 61

configuration 10
configurations 10
connect to WLAN 111
contacts 47, 71
conventions
 notational 11
cradle
 connector cleaning 152
cradle mount 117
cradle mounting adapter 118

D

data capture 10, 96
datawedge 47, 104
datawedge demo 83
DC line cord 119
display
 cleaning 152
display settings 28
downloads 47
DWDemo 48

E

EAP 111
emergency calling 56
extended power pack 117

F

feature 14
file browser 48, 67
file transfer 54
font size 29

G

gallery 78

- H**
- hand strap 118
 - handset mode 56
 - hands-free imager 97
 - hard reset 53
 - harmful ingredients 151
 - headset mode 56
 - home screen 33
 - home screen rotation 34
- I**
- imager scanning 96
 - information, service 11
- K**
- keyboard 42
- L**
- light sensor 15
 - low battery notification 27
- M**
- memory 10
 - microSD card 16, 22
- N**
- notification icons 37
- O**
- operating system 10
- P**
- panoramic 74
 - panoramic photos 74
 - photo settings 75
 - photo transfer 54
 - photos 73
 - taking photos 73
 - picklist 96
 - power supply 118
 - proximity sensor 15
 - PTT button 14
 - PTT Express 86
- R**
- recoding videos 74
 - recording videos 74
 - related documents 11
 - related software 11
 - reseting the device 53
 - resetting 53
 - RS507 scanning 102
 - RS6000 scanning 100
 - RxLogger 90
- S**
- scan button 14
 - scanning 96, 98, 99
 - scanning application 83
 - screen
 - unlocking 50
 - screen font size 29
 - screen protector 118
 - screen rotation 29
 - screen timeout 29
 - security 111
 - sensors 158
 - set font size 29
 - setting
 - camera 75
 - font 29
 - sounds 30
 - video 76
 - wakeup sources 32
 - setting date 28
 - setting time 28
 - settings 49
 - display 28
 - SIM card 24
 - soft holster 118
 - soft reset 53
 - sound recorder 85
 - sound recordet 49
 - sound settings 30
 - speaker 14
 - speaker mode 56
 - status icons 35
 - suspend mode 53
 - sybologies 160
- T**
- taking a panoramic photo 74
 - taking panoramic photos 74
 - touchscreen 42
 - transferring files using USB 54
 - trigger handle 118
 - troubleshooting 154

U

unlocking the screen	50
USB	54
using a Bluetooth headset	56
using the dialer	57

V

video settings	76
videos	73, 74

W

wakeup sources	32
WEP	111
wi-fi network	111
wireless local area network	105
WLAN	105
WPA	111
wrist mount	118

