



MC67 with Android™ OS



Mobile Computer

User Guide for AOSP Version 4.4.4



MC67 WITH ANDROID™ OS USER GUIDE FOR AOSP VERSION 4.4.4

MN002642A02

Rev. A

January 2017

Copyright

© 2016 Symbol Technologies LLC, a subsidiary of Zebra Technologies Corporation. All Rights Reserved.

The products described in this document may include copyrighted computer programs. Laws in the United States and other countries preserve for certain exclusive rights for copyrighted computer programs. Accordingly, any copyrighted computer programs contained in the products described in this document may not be copied or reproduced in any manner without the express written permission.

No part of this document may be reproduced, transmitted, stored in a retrieval system, or translated into any language or computer language, in any form or by any means, without the prior written permission.

Furthermore, the purchase of our products shall not be deemed to grant either directly or by implication, estoppel or otherwise, any license under the copyrights, patents or patent applications, except for the normal non-exclusive, royalty-free license to use that arises by operation of law in the sale of a product.

Disclaimer

Please note that certain features, facilities, and capabilities described in this document may not be applicable to or licensed for use on a particular system, or may be dependent upon the characteristics of a particular mobile subscriber unit or configuration of certain parameters. Please refer to your contact for further information.

Trademarks

Zebra and the stylized Zebra head are trademarks of ZIH Corp., registered in many jurisdictions worldwide. All other trademarks are the property of their respective owners.

Revision History

Changes to the original guide are listed below:

Change	Date	Description
-01 Rev A	3/2016	Initial release.
-02 Rev A	1/2017	Update low battery notification information.

TABLE OF CONTENTS

Copyright.....	ii
Disclaimer	ii
Trademarks.....	ii
Revision History	iii

Table of Contents

About This Guide

Documentation Set	xiii
Configurations.....	xiii
Software Versions.....	xiv
Chapter Descriptions	xiv
Notational Conventions.....	xiv
Icon Conventions	xv
Related Documents	xv
Service Information	xv

Chapter 1: Getting Started

Unpacking	1-1
Features	1-2
Setup	1-3
Installing the SIM Card	1-4
Installing the Battery	1-5
Charging the Battery	1-5
LED Charging Indicators	1-6
Replacing the Battery	1-6
Replacing the microSD Card	1-7
Replacing the SIM Card	1-8
Battery Management	1-9
Monitor Battery Usage	1-9
Low Battery Notification	1-10
Battery Optimization	1-10

Turning Off the Radios	1-10
Setting the Date and Time	1-11
Display Setting	1-11
Setting the Screen Brightness	1-11
Setting Screen Rotation	1-12
Setting Screen Timeout Setting	1-12
Setting Font Size	1-12
General Sound Setting	1-13

Chapter 2: Using the MC67

Home Screen	2-1
Status Bar	2-2
Status Icons	2-2
Notification Icons	2-4
Managing Notifications	2-5
Application Shortcuts and Widgets	2-6
Adding an Application or Widget to the Home Screen	2-6
Moving Items on the Home Screen	2-6
Removing an App or Widget from the Home Screen	2-6
Folders	2-7
Creating a Folder	2-7
Naming Folders	2-7
Removing a Folder	2-7
Home Screen Wallpaper	2-7
Changing the Home Screen Wallpaper	2-7
Stylus and Touchscreen	2-8
Using the On-screen Keyboard	2-8
Editing Text	2-8
Entering Numbers, Symbols and Special Characters	2-8
Keypads	2-9
Applications	2-9
Accessing Applications	2-12
Switching Between Recent Applications	2-12
Un-Locking the Screen	2-13
Single User Mode	2-13
MultiUser Mode	2-14
MultiUser Login	2-15
MultiUser Logout	2-15
Resetting the Device	2-15
Performing a Soft Reset	2-15
Performing a Hard Reset	2-15
Suspend Mode	2-16
LED Indicators	2-16

Chapter 3: Calls

Emergency Calling	3-1
Audio Modes	3-1
Using a Bluetooth Headset	3-1

Adjusting Audio Volume	3-2
Making a Call Using the Dialer	3-2
Making a Call Using Contacts	3-3
Making a Call Using Call History	3-3
Making a Conference Call	3-4
Making a Call Using a Bluetooth Headset	3-6
Answering Calls	3-6
Answering Calls with a Bluetooth Headset	3-7
Call Settings	3-8

Chapter 4: Applications

File Browser	4-1
Messaging	4-2
Sending a Text Message	4-2
People	4-3
Adding People	4-3
Editing People	4-3
Deleting People	4-3
Camera	4-4
Taking Photos	4-4
Taking a Panoramic Photo	4-4
Recording Videos	4-5
Camera Settings	4-6
Video Settings	4-7
Gallery	4-8
Working with Albums	4-9
Share an Album	4-9
Get Album Information	4-9
Deleting an Album	4-9
Working with Photos	4-10
Viewing and Browsing Photos	4-10
Rotating a Photo	4-10
Cropping a Photo	4-10
Edit a Photo	4-11
Setting a Photo as a Contact Icon	4-12
Get Photo Information	4-12
Share a Photo	4-12
Deleting a Photo	4-13
Working with Videos	4-13
Watching Videos	4-13
Sharing a Video	4-13
Deleting a Video	4-14
DataWedge Demonstration	4-15
Sound Recorder	4-16
MLog Manager	4-16
PTT Express Voice Client	4-16
PTT Audible Indicators	4-17
Notification Icons	4-17
Enabling PTT Communication	4-18

Selecting a Talk Group	4-19
PTT Communication	4-19
Creating a Group Call	4-19
Disabling PTT Express Voice Client Communication	4-19
Elemex	4-20
Disabling Elemex Data Collection	4-20
Enabling Elemex Data Collection	4-21

Chapter 5: Data Capture

Imaging	5-1
Operational Modes	5-1
Digital Camera	5-2
Scanning Considerations	5-2
Imager Scanning	5-3
Digital Camera Scanning	5-4
Bar Code Capture with RS507 Hands-Free Imager	5-4
Pairing the RS507 Hands-Free Imager Using SSI	5-5
Pairing the RS507 Hands-Free Imager Bluetooth HID	5-6
DataWedge	5-7
Enabling DataWedge	5-7
Disabling DataWedge	5-7

Chapter 6: Wireless

Wireless Wide Area Networks	6-1
Sharing the Mobile Data Connection	6-1
USB Tethering	6-2
Wi-Fi Tethering	6-2
Bluetooth Tethering	6-2
Disabling Data When Roaming	6-3
Limiting Data Connection to 2G Networks	6-3
Locking the SIM Card	6-3
Editing the Access Point Name	6-4
Wireless Local Area Networks	6-4
Scan and Connect to a Wi-Fi Network	6-5
Configuring a Wi-Fi Network	6-6
Manually Adding a Wi-Fi Network	6-7
Configuring for a Proxy Server	6-8
Configuring the Device to Use a Static IP Address	6-9
Advanced Wi-Fi Settings	6-9
Remove a Wi-Fi Network	6-11
Bluetooth	6-11
Adaptive Frequency Hopping	6-12
Security	6-12
Bluetooth Profiles	6-13
Bluetooth Power States	6-13
Bluetooth Radio Power	6-13
Enabling Bluetooth	6-14
Disabling Bluetooth	6-14

Discovering Bluetooth Device(s)	6-14
Changing the Bluetooth Name	6-15
Connecting to a Bluetooth Device	6-15
Selecting Profiles on the Bluetooth Device	6-15
Unpairing a Bluetooth Device	6-16
Data Usage	6-16
Mobile Data Usage	6-16
Wi-Fi Data Usage	6-17
Ethernet Data Usage	6-17
Set Auto-Sync	6-17

Chapter 7: Accessories

Accessories	7-1
Single Slot USB Cradle	7-3
Charging the MC67 Battery	7-3
Charging a Spare Battery	7-4
Battery Charging	7-4
Charging Temperature	7-4
Four Slot Charge Only Cradle	7-4
Charging the MC67	7-4
Battery Charging	7-5
Main Battery Charging	7-5
Charging Temperature	7-5
Four Slot Ethernet Cradle	7-5
Charging the MC67	7-5
Battery Charging	7-6
Main Battery Charging	7-6
Charging Temperature	7-6
Establishing Ethernet Connection	7-6
LED Indicators (CRD5501-4000ER)	7-7
Single-slot Ethernet/Modem/USB Cradle	7-7
Indicators	7-8
Ethernet Operation	7-8
USB Operation	7-8
Four Slot Battery Charger	7-9
Charging Spare Batteries	7-9
Battery Charging	7-9
Spare Battery Charging	7-9
Charging Temperature	7-9
Magnetic Stripe Reader	7-10
Attaching the MSR	7-10
Removing the MSR	7-10
Using the MSR	7-10
VCD5000-1001R Vehicle Cradle	7-12
Charging the MC67 Battery	7-12
Removing the MC67	7-12
Battery Charging Indicators	7-13
Charging Temperature	7-13
Cables	7-13

Battery Charging and Operating Power	7-14
LED Charge Indications	7-15
Charging Temperature	7-15
Vehicle Holder	7-17
Assembly	7-17
Windshield Installation	7-17
Flat Surface Installation	7-18
Trigger Handle	7-20
Inserting the MC67 into the Trigger Handle	7-20
Removing the MC67	7-21
Scanning	7-21

Chapter 8: Maintenance and Troubleshooting

Maintaining the MC67	8-1
Removing the Screen Protector	8-2
Battery Safety Guidelines	8-2
Cleaning Instructions	8-3
Approved Cleanser Active Ingredients	8-3
Harmful Ingredients	8-3
Cleaning Instructions	8-4
Special Cleaning Notes	8-4
Cleaning Materials Required	8-4
Cleaning Frequency	8-4
Approved Cleanser Active Ingredients	8-4
Harmful Ingredients	8-4
Cleaning Instructions	8-4
Special Cleaning Notes	8-5
Cleaning Materials Required	8-5
Cleaning the MC67	8-5
Housing	8-5
Display	8-5
Camera and Exit Window	8-5
Connector Cleaning	8-5
Cleaning Cradle Connectors	8-6
Troubleshooting	8-6
MC67	8-6
Single Slot USB Cradle	8-9
Four Slot Charge Only Cradle	8-10
Four Slot Ethernet Cradle	8-10
Vehicle Cradle	8-11
Four Slot Battery Charger	8-11
Cables	8-11
Magnetic Stripe Reader	8-12

Chapter A: Technical Specifications

MC67	A-1
------------	-----

Chapter B: Keypads

Numeric Keypad Configuration B-1
Alpha-numeric Keypad Configurations B-4
DSD Keypad Configuration B-7

Index

ABOUT THIS GUIDE

This guide provides information about using the MC67 mobile computer and accessories.

✓ **NOTE** Screens and windows pictured in this guide are samples and can differ from actual screens.

Documentation Set

The documentation set for the MC67 provides information for specific user needs, and includes:

- *MC67 Quick Start Guide* - describes how to get the MC67 up and running.
- *MC67 User Guide* - describes how to use the MC67.
- *MC67 Integrator Guide* - describes how to set up the MC67 and accessories.

Configurations



This guide covers the following configurations:

Configuration	Radios	Display	Memory	Data Capture Options	Operating System	Keypads
MC67NA	WLAN: 802.11 a/b/g/n WPAN: Bluetooth v2.1 EDR WWAN:GSM/ UMTS GPS: Stand-alone GPS or A-GPS	3.5" VGA Color	1 GB RAM / 8 GB Flash	2D imager and camera	Android-based , Android Open-Source Project 4.4.4.	Numeric, QWERTY, QWERTZ, AZERTY or DSD

Software Versions

To determine the current software versions touch  >  >  **About phone**.

- **Model number**- Displays the model number.
- **Android version** - Displays the operating system version.
- **Kernel version** - Displays the kernel version number.
- **Build number** - Displays the software build number.

To determine the device serial number touch  >  >  **About phone** > **Status**.

- **Serial number** - Displays the serial number.

Chapter Descriptions

Topics covered in this guide are as follows:

- [Chapter 1, Getting Started](#) provides information on getting the MC67 up and running for the first time.
- [Chapter 2, Using the MC67](#) provides information for operating the MC67.
- [Chapter 3, Calls](#) provides instructions for making phone calls.
- [Chapter 4, Applications](#) provides information on using applications installed on the MC67.
- [Chapter 5, Data Capture](#) provides information for capturing bar code data using the imager or camera.
- [Chapter 6, Wireless](#) provides information on the various wireless options.
- [Chapter 7, Accessories](#) provides information for using the accessories for the MC67.
- [Chapter 8, Maintenance and Troubleshooting](#) includes instructions on cleaning and provides troubleshooting solutions for potential problems during MC67 operation.
- [Chapter A, Technical Specifications](#) provides the technical specifications for the MC67.
- [Chapter B, Keypads](#) provides information on the three types of keypads available on the MC67.

Notational Conventions

The following conventions are used in this document:

- *Italics* are used to highlight the following:
 - Chapters and sections in this and related documents
 - Icons on a screen.
- **Bold** text is used to highlight the following:
 - Dialog box, window, and screen names
 - Drop-down list and list box names
 - Check box and radio button names
 - Button names on a screen.

- Bullets (•) indicate:
 - Action items
 - Lists of alternatives
 - Lists of required steps that are not necessarily sequential
- Sequential lists (for example, lists that describe step-by-step procedures) appear as numbered lists.

Icon Conventions

The documentation set is designed to give the reader more visual clues. The following graphic icons are used throughout the documentation set. These icons and their associated meanings are described below.



WARNING! The word **WARNING** with the associated safety icon implies information that, if disregarded, could result in death or serious injury, or serious product damage.



CAUTION The word **CAUTION** with the associated safety icon implies information that, if disregarded, may result in minor or moderate injury, or serious product damage.



NOTE NOTE contains information more important than the surrounding text, such as exceptions or preconditions. They also refer the reader elsewhere for additional information, remind the reader how to complete an action (when it is not part of the current procedure, for instance), or tell the reader where something is located on the screen. There is no warning level associated with a note.

Related Documents

- *MC67 with Android OS Quick Start Guide*, p/n MN000114Axx.
- *MC67 with Android OS Regulatory Guide*, p/n MN000149Axx.
- *MC67 with Android OS Integrator Guide*, p/n MN002643Axx.

For the latest version of this guide and all guides, go to: <http://www.zebra.com/support>.

Service Information

If you have a problem with the equipment, contact Global Customer Support in the region. Contact information is available at: <http://www.zebra.com/support>.

When contacting support, please have the following information available:

- Serial number of the unit (found on manufacturing label)
- Model number or product name (found on manufacturing label)
- Software type and version number
- IMEI number

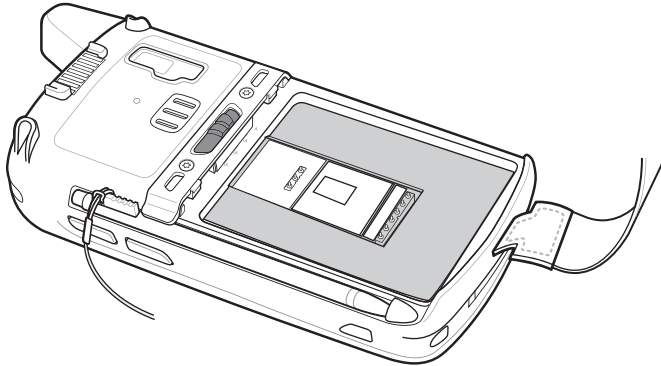

Customer Support responds to calls by email or telephone within the time limits set forth in support agreements.

If the problem cannot be solved by Global Customer Support, the user may need to return the equipment for servicing and will be given specific directions. We are not responsible for any damages incurred during shipment if the approved shipping container is not used. Shipping the units improperly can possibly void the warranty. Remove the SIM card and/or microSD card from the device before shipping for service.

If the device was purchased from a business partner, contact that business partner for support.

CHAPTER 1 GETTING STARTED

This chapter provides information for getting the device up and running for the first time.

Unpacking

1. Carefully remove all protective material from the MC67 and save the shipping container for later storage and shipping.
2. Verify that the following were received:
 - MC67 mobile computer with 4 GB microSD card
 - 3600 mAh Lithium-ion battery
 - Stylus with tether (installed)
 - Regulatory Guide
 - Quick Start Guide.
3. Inspect the equipment for damage. If any equipment is missing or damaged, contact the Global Customer Support center immediately.
4. Prior to using the MC67 for the first time, remove the protective shipping film that covers the scan window, display and camera window.

Features

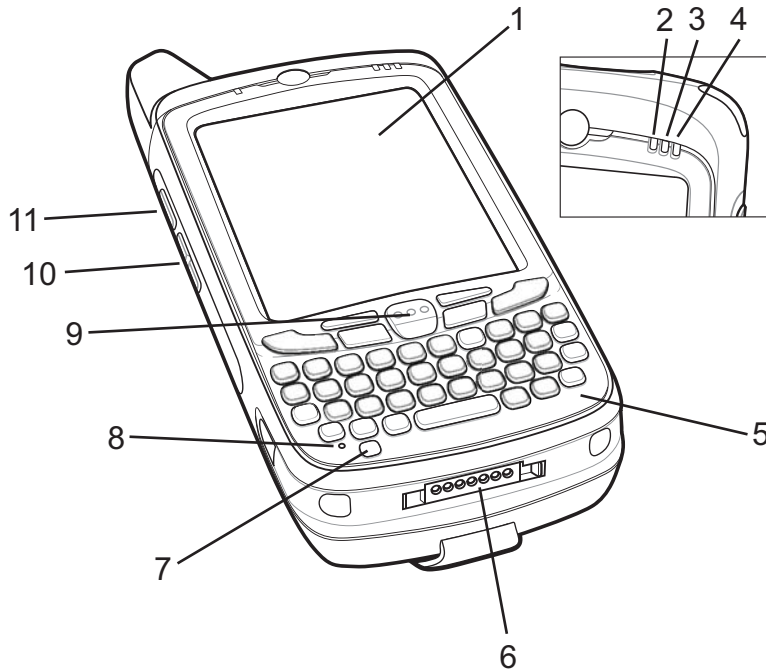

Figure 1-1 MC67 Front View

Table 1-1 Front View Features

Number	Item	Function
1	Touch Screen	Displays all information needed to operate the MC67.
2	Data Capture LED	Indicates data capture status.
3	Charging/Battery Status LED	Indicates battery charging status.
4	WAN Radio Status LED	Indicate WAN radio status.
5	Keypad	Use to enter numbers and characters.
6	I/O Connector	Provides charging and data communication.
7	Power Button	Turns the display on and off. Press and hold to reset the device, place device in Airplane Mode or swap the battery.
8	Microphone	Use for communications in Handset mode.
9	Scan Button	Initiates data capture.
10	Volume Up/Down Button	Increase and decrease audio volume.
11	Scan/Action Button	Initiates data capture (programmable).

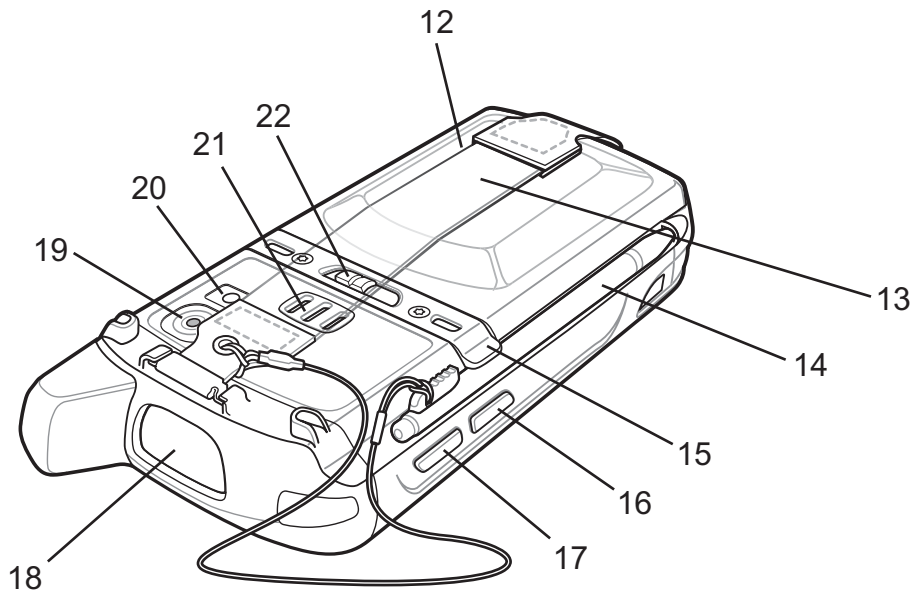

Figure 1-2 MC67 Rear View

Table 1-2 Back View Features

Number	Item	Function
12	Battery	Provides power to the device.
13	Handstrap	Use for securely holding the device.
14	Stylus	Use to select items on the screen.
15	Stylus Clip	Use to hold the stylus securely in place.
16	Action Button	Programmable button.
17	Scan/Action Button	Initiates data capture (programmable).
18	Exit Window	Provides data capture using the imager.
19	Camera	Takes photos, videos and captures bar code data.
20	Camera Flash	Provides illumination for the camera.
21	Speaker	Provides audio output for video and music playback. Provides audio in speakerphone mode.
22	Battery Latch	Securely holds the battery in place.

Setup

Perform this procedure to start using the MC67 for the first time.

1. Install the subscriber identification module (SIM) card.
2. Install the battery.

3. Charge the MC67.
4. Power on the MC67.

Installing the SIM Card

Global System for Mobile communications (GSM) phone service requires a SIM card. Obtain the card from a service provider. The card fits into the MC67 and can contain the following information:

- Mobile phone service provider account details
- Information regarding service access and preferences
- Contact information, which can be moved to Contacts on the MC67
- Any additional subscribed services.

✓ **NOTE** For more information about SIM cards, refer to the service provider's documentation.

1. To install the SIM card, lift rubber access door.
2. Slide the SIM card holder up to unlock.
3. Lift the SIM card holder door.

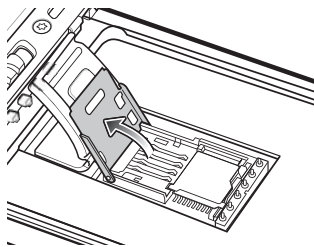

Figure 1-3 *Lifting the SIM Cover*

4. Insert the SIM card, as shown in [Figure 1-4](#) ensuring that the card slides into the holding tabs on each side of the door.

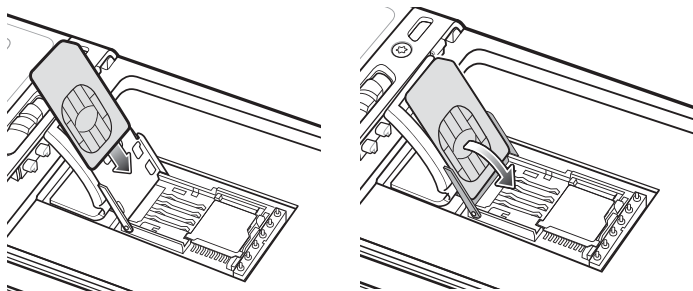

Figure 1-4 *Inserting the SIM Card*

5. Close the SIM card holder door and slide down to lock into place.
6. Close the rubber access door.
7. Install the battery.

Installing the Battery

To install the battery:

1. Insert the battery, bottom first, into the battery compartment in the back of the MC67.
2. Press the battery down into the battery compartment until the battery release latch snaps (two clicks) into place.

If the battery has significant charge, the MC67 turns on.

3. Replace the handstrap.

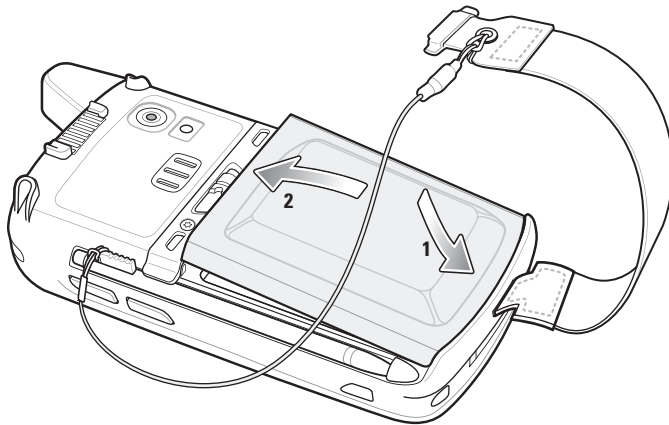

Figure 1-5 Inserting the Battery

Charging the Battery

Before using the MC67 for the first time, charge the main battery until the amber Charging/Battery Status light emitting diode (LED) remains lit. To charge the MC67, use a cable or a cradle with the appropriate power supply. For information about the accessories available for the MC67, see [Chapter 7, Accessories](#) for more information.

The MC67 is equipped with a backup battery which automatically charges from the fully-charged main battery. When using the MC67 for the first time, the backup battery requires approximately 40 hours to fully charge. This is also true any time the backup battery is discharged, which occurs when the main battery is removed for several hours. The backup battery retains random access memory (RAM) data in memory for at least 10 minutes (at room temperature) when the MC67's main battery is removed. When the MC67 reaches a very low battery state, the combination of main battery and backup battery retains RAM data in memory for at least 36 hours.

For cable and cradle setup and charging procedures refer to the *MC67 Integrator Guide*.

- USB Charging Cable
- Charge Only Cable
- Single Slot USB Cradle
- Four Slot Charge Only Cradle
- Four Slot Ethernet Cradle.

Charge batteries in temperatures from 0 °C to 40 °C (32 °F to 104 °F). Note that charging is intelligently controlled by the MC67. To accomplish this, for small periods of time, the MC67 or accessory alternately enables and disables battery charging to keep the battery at acceptable temperatures. The MC67 or accessory indicates when charging is disabled due to abnormal temperatures via its LED.

1. To charge the main battery, connect the charging accessory to the appropriate power source.

2. Insert the MC67 into a cradle or attach to a cable. The MC67 turns on and begins charging. The Charging/Battery Status LED blinks amber while charging, then turns solid amber when fully charged.

LED Charging Indicators

Table 1-3 LED Charging Indicators

Charging/Battery Status LED	Indication
Off	MC67 is not charging. MC67 is not inserted correctly in the cradle or connected to a power source. Charger/cradle is not powered.
Slow Blinking Amber (1 blink every 2 seconds)	MC67 is charging.
Solid Amber	Charging complete. Note: When the battery is initially inserted in the MC67, the amber LED flashes once if the battery power is low or the battery is not fully inserted.
Fast Blinking Amber (2 blinks/second)	Charging error, e.g.: <ul style="list-style-type: none"> • Temperature is too low or too high. • Charging has gone on too long without completion (typically eight hours).

Replacing the Battery

1. If the MC67 is in a cradle, remove it before performing a Safe Battery Swap.
2. Unclip the handstrap.
3. Press and hold the Power button until the menu appears.

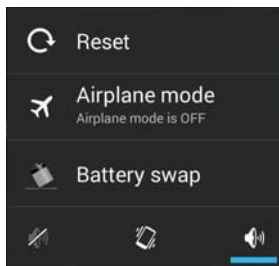

Figure 1-6 Power Button Menu

4. Touch **Battery swap**. The red Data Capture LED turns on.
5. Wait for the red Data Capture LED to turn off.
6. Slide the battery latch to the right. The battery ejects slightly.

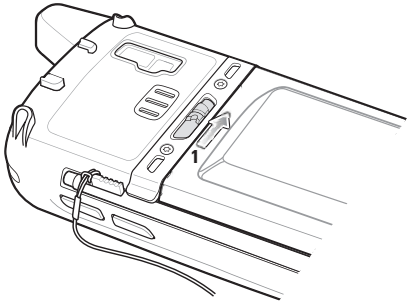

Figure 1-7 *Slide Latch to the Right*

7. Lift the battery from the MC67.

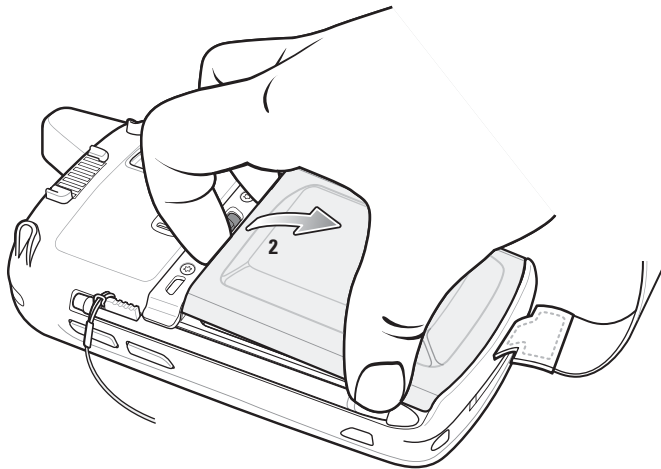

Figure 1-8 *Lift the Battery*

8. Insert the replacement battery, bottom first, into the battery compartment in the back of the MC67.
9. Press the battery down until the battery release latch snaps (two clicks) into place.
10. Replace the handstrap.
11. Press the Power button to wake the MC67.

Replacing the microSD Card

To replace the microSD card:

1. If the MC67 is in a cradle, remove it before performing a Safe Battery Swap.
2. Unclip the handstrap.
3. Press and hold the Power button until the menu appears.
4. Touch **Battery swap**.

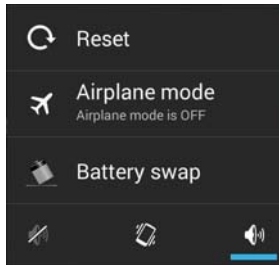

Figure 1-9 Power Button Menu

5. Wait for the red Data Capture LED to turn off.
6. Remove the battery.
7. Lift the rubber access door.
8. Slide SIM card holder door up to unlock.
9. Lift SIM Card holder door.
10. Lift the microSD card holder door.
11. Remove microSD card from holder.
12. Close microSD card holder door.
13. Close SIM card holder door.
14. Slide SIM card holder door down to lock into place.
15. Close the rubber access door.
16. Insert the battery, bottom first, into the battery compartment in the back of the MC67.
17. Press the battery down until the battery release latch snaps (two clicks) into place.
18. Replace the handstrap.
19. Press the Power button to wake the MC67.
20. If a SIM card is installed, perform a soft reset. See [Performing a Soft Reset on page 2-15](#).

Replacing the SIM Card

To replace the SIM card:

1. If the MC67 is in a cradle, remove it before performing a Safe Battery Swap.
2. Unclip the handstrap.
3. Press and hold the Power button until the menu appears.
4. Touch **Battery swap**.
5. Wait for the red Data Capture LED to turn off.
6. Remove the battery.
7. Lift the rubber access door.

8. Slide SIM card holder door up to unlock.
9. Lift the SIM Card holder door.
10. Remove SIM card from holder.
11. Close SIM card holder door.
12. Slide SIM card holder door down to lock into place.
13. Close the rubber access door.
14. Insert the battery, bottom first, into the battery compartment in the back of the MC67.
15. Press the battery down until the battery release latch snaps (two clicks) into place.
16. Replace the handstrap.
17. Perform a soft reset. See [Performing a Soft Reset on page 2-15](#).

Battery Management

✓ **NOTE** Prior to checking the battery charge level, remove the MC67 from any AC power source (cradle or cable).

To check the charge status of the main battery, on the Home screen touch  >  >  **About phone** > **Status**.

Battery status indicates that the battery is discharging and **Battery level** lists the battery charge (as a percentage of fully charged).

Monitor Battery Usage

The Battery screen lists which applications consume the most battery power. Also use it to turn off applications that were downloaded if they are consuming too much power.

Touch  >  > **Battery**.

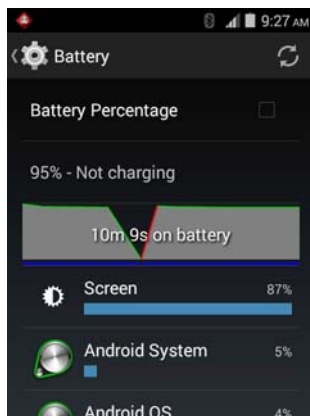



Figure 1-10 Battery Screen

The Battery screen lists the applications using the battery. The discharge graph at the top of the screen shows the rate of the battery discharge since last charged (short periods of time when connected to a charger are shown as thin green lines at the bottom of the chart), and how long it has been running on battery power.

Touch an application in the Battery screen to display details about its power consumption. Different applications display different information. Some applications include buttons that open screens with settings to adjust power use.

Low Battery Notification

When the battery charge level drops below 15%, the MC67 battery status icon in the status bar turns red . The user should charge the battery using one of the charging accessories.

When the battery charge drops below 14%, the MC67 displays a notice to connect the MC67 to power. The user must charge the battery using one of the charging accessories.

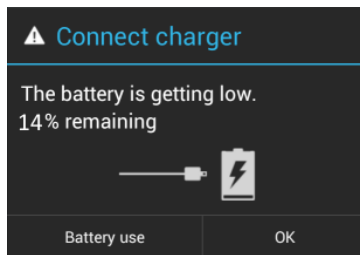

Figure 1-11 *Low Battery Notification*

When the battery charge drops below 11%, the MC67 turns off and enters critical suspend mode. The user cannot turn on the device until charged. The user must charge the MC67 using one of the charging accessories.

Battery Optimization



Observe the following battery saving tips:

- Leave the MC67 connected to AC power at all times when not in use.
- Set the screen to turn off after a short period of non-use. See [Setting Screen Timeout Setting on page 1-12](#).
- Reduce screen brightness. See [Setting the Screen Brightness on page 1-11](#).
- Turn off all wireless radios when not in use. Note that the global positioning system (GPS) receiver is only turned on when a GPS application is using the GPS radio.
- Turn off automatic syncing for Email, Calendar, Contacts and other applications.
- Use the **Power Control** widget to check and control the status of radios, the screen brightness, and syncing.
- Minimize use of applications that keep the MC67 from suspending, for example, music, GPS and video applications.

Turning Off the Radios





To turn off all the radios:

1. Press the Power button until the menu appears.
 2. Touch **Airplane mode**. The airplane icon  appears in the Status bar indicating that all the radios are off.
- or
1. Touch the Status bar and drag down to open the notification panel.

2. Touch  > . The airplane icon  appears in the Status bar indicating that all the radios are off.

Setting the Date and Time

The date and time is automatically synchronized using an NITZ server when the MC67 is connected to a cellular network. The user is only required to set the time zone or set the date and time when not connected to a cellular network.

1. Touch  >  >  **Date & time**.
2. Touch **Automatic date & time** to disable automatic date and time synchronization.
3. Touch **Set date**.
4. Move the sliders up and down to select the month, date and year.
5. Touch **Done**.
6. Touch **Set time**.
7. Move the sliders up and down to select the hour, minutes and part of the day.
8. Touch **Done**.
9. Touch **Select time zone**.
10. Select the current time zone from the list.
11. Touch .

Display Setting

Use Display settings to change the screen brightness, change the background image, enable screen rotation, set sleep time and change font size.

Setting the Screen Brightness

To set the screen brightness:

1. Touch  > .
2. Touch  **Display**.
3. Touch **Brightness**.

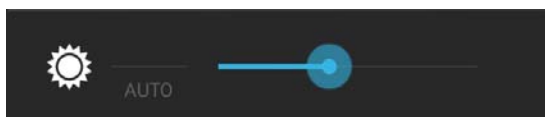







Figure 1-12 *Brightness Dialog Box*

4. In the Brightness dialog box, check the **Automatic brightness** checkbox to set the MC67 to automatically adjust the brightness using the built-in light sensor. Uncheck the checkbox to set the brightness manually. Use the slider to set a brightness level.

5. Touch **OK**.
6. Touch .





Setting Screen Rotation

By default, screen rotation is disabled. To enable screen rotation:

1. Touch  > .
2. Touch  **Display**.
3. Check **Auto-rotate screen** to set the MC67 to automatically switch orientation when the MC67 is rotated.
The Home screen does not rotate.
4. Touch .

Setting Screen Timeout Setting

To set the screen sleep time:

1. Touch  > .
2. Touch  **Display**.
3. Touch **Sleep**.
4. Select one of the sleep values.
 - **15 seconds**
 - **30 seconds**
 - **1 minute** (default)
 - **2 minutes**
 - **5 minutes**
 - **10 minutes**
 - **30 minutes**
5. Touch .

Setting Font Size



To set the size of the font in system applications:

1. Touch  > .
2. Touch  **Display**.
3. Touch **Font size**.
4. Select one of the font size values.
 - **Small**

- **Normal** (default)
- **Large**
- **Huge**

5. Touch .

General Sound Setting

Use the Sounds settings to configure media and alarm volumes. On the Home screen, touch  >  >  **Sounds**.

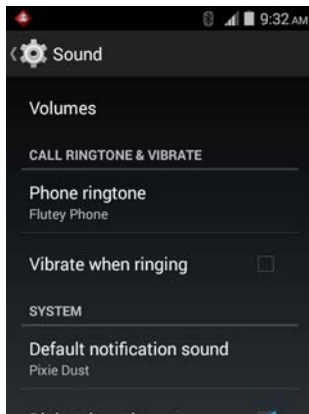

Figure 1-13 *Sounds Screen*

- **Volumes** – Use to change the volume of media, ringtones, notifications and alarms.

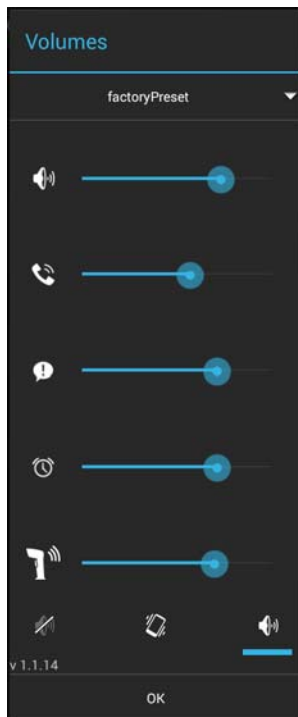









Figure 1-14 Volumes Dialog Box

-  - Controls the music and media volume.
-  - Controls the ringtone volume.
-  - Controls the system notification volume.
-  - Controls the alarm clock volume.
-  - Controls the scan good decode beep volume.
- Bottom row icons:
 -  - Places all sounds except media and alarms in silence mode.
 -  - Places all sounds except media and alarms in vibrate mode.
 -  - Places all sounds in sound mode.
- **Call Ringtone and Vibrate**
 - **Phone ringtone** - Touch to select a ringtone to sound when an incoming call is received.
 - **Vibrate when ringing** - Check to make the device vibrate when a call is received (default – enabled).

- **System**

- **Default notification** - Touch to select a sound to play for all system notifications.
- **Dial pad touch tones** - Check to play a sound when a phone key is touched (default – enabled).
- **Touch sounds** - Check to play a sound when making screen selections (default – enabled).
- **Screen lock sounds**- Check to play a sound when locking and unlocking the screen (default – disabled).
- **Vibrate on touch**- Check to have the device vibrate when touching soft keys and on certain screen interactions (default – disabled).

CHAPTER 2 USING THE MC67

This chapter explains the buttons, status icons, and controls on the MC67, and provides basic instructions for using the MC67, including resetting the MC67 and entering data.

Home Screen

The Home screen displays when the MC67 turns on. Depending upon the configuration, the Home screen might appear different. Contact your system administrator for more information.



After a suspend or screen time-out, the Home screen displays with the lock sliders. Slide  to the right toward  to unlock the screen. For screen locking information see [Un-Locking the Screen on page 2-13](#).



Figure 2-1 Home Screen

Table 2-1 Home Screen Items

Item	Description
1 — Status Bar	Displays the time, status icons (right side), and notification icons (left side). For more information see Status Icons on page 2-2 and Managing Notifications on page 2-5 .
2 — Shortcut Icons	Opens applications installed on the MC67. See Application Shortcuts and Widgets on page 2-6 for more information.
3 — Browser Icon	Opens the Browser application.
4 — All Apps Icon	Opens the APPS window.
5 — Phone Icon	Opens the Dialer window.
6 — Widgets	Launches stand-alone applications that run on the Home screen. See Application Shortcuts and Widgets on page 2-6 for more information.

The Home screen provides four additional screens for placement of widgets and shortcuts. Swipe the screen left or right to view the additional screens.

Status Bar

The Status bar displays the time, notification icons (left side) and status icons (right side).

**Figure 2-2** Notification and Status Icons

If there are more notifications than can fit in the Status bar,  displays indicating that more notifications exist. Open the Notifications panel to view all notifications and status.

Status Icons

Table 2-2 Status Icon



Icon	Description
	Indicates that GPS locationing is in use.
	Indicates that the Alarm is active.
	Indicates that all sounds except media and alarms are silenced and vibrate mode is active.

Table 2-2 Status Icon (Continued)

























Icon	Description
	Indicates that the ringer is silenced.
	Microphone is muted during a call.
	Indicates that the battery is fully charged.
	Indicates that the battery is partially drained.
	Indicates that the battery charge is low.
	Indicates that the battery charge is very low.
	Indicates that the battery is charging.
	Indicates that the Airplane Mode is active. All radios are turned off.
	Indicates that Bluetooth is on.
	Connected to a Wi-Fi network.
	No Wi-Fi signal.
	Connected to an Ethernet network.
	Mobile network signal strength.
	No mobile network signal.
	Connected to a 3G network.
	Connected to an HSPA network.

Table 2-2 *Status Icon (Continued)*

Icon	Description
	Connected to an EDGE network.
	Connected to an GPRS network.
	Roaming from a network.
	No SIM card installed.
	Indicates that the Orange key is pressed.
	Indicates that the Orange key is locked.
	Indicates that the Blue key is pressed.
	Indicates that the Shift key is pressed.
	Indicates that the Shift key is locked.

Notification Icons

Table 2-3 *Notification Icons*



















Icon	Description
	Indicates that more notifications are available for viewing.
	Indicates that data is syncing.
	Indicates an upcoming event.
	Indicates that an open Wi-Fi network is available.
	Indicates that a song is playing.

Table 2-3 Notification Icons (Continued)

Icon	Description
	Indicates that a problem with sign-in or sync has occurred.
	Indicates that the MC67 is uploading data.
	Indicates that the microSD card is almost full.
	Indicates that the MC67 is downloading data when animated and download is complete when static.
	Indicates that the MC67 is connected via USB cable.
	Indicates that the MC67 is connected to or disconnected from virtual private network (VPN).
	Preparing SD card.
	Indicates that USB debugging is enabled on the MC67.
	Indicates that the MultiUser feature is enabled.
	Indicates that a new user is logging in.
	Indicates that the MC67 has received a text message.
	Indicates a missed call.
	Indicates that USB tethering is active.
	Indicates the status of the PTT Express Voice Client.

Managing Notifications

Notification icons report the arrival of new messages, calendar events, and alarms, as well as ongoing events. When a notification occurs, an icon appears in the Status bar with a brief description. See [Notification Icons on page 2-4](#) for a list of possible notification icons and their description. Open the **Notifications** panel to view a list of all the notifications.

To open the Notification panel drag the Status bar down from the top of the screen.

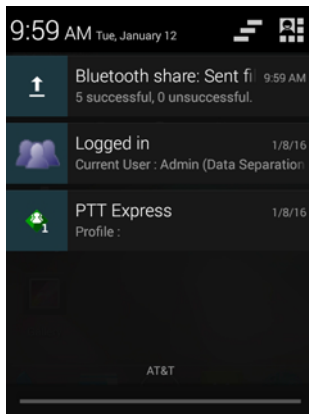



Figure 2-3 Notification Panel

To respond to a notification, open the Notifications Panel and then touch a notification. The Notifications Panel closes and the subsequent activity is dependent on the notification.

To clear all notifications, open the Notifications Panel and then touch . All event-based notifications are removed. Ongoing notifications remain in the list.

To close the Notification Panel, drag the bottom of the Notifications Panel to the top of the screen or touch .

Application Shortcuts and Widgets

Application shortcuts placed on the Home screen allow quick and easy access to applications. Widgets are self-contained applications placed on the Home screen to access frequently used features.

Adding an Application or Widget to the Home Screen

1. Go to the desired Home screen.
2. Tap .
3. Swipe left, if necessary, to find the application icon or widget.
4. Tap and hold the icon or widget until the Home screen appears.
5. Position the icon on the screen and then release.

Moving Items on the Home Screen

1. Tap and hold the item until it floats on the screen.
2. Drag the item to a new location. Pause at the edge of the screen to drag the item onto an adjacent Home screen.
3. Lift finger to place the item on the Home screen.

Removing an App or Widget from the Home Screen

1. Go to the desired Home screen.
2. Tap and hold the application shortcut or widget icon until it floats on the screen.

3. Drag the icon to  **Remove** on the top of the screen and then release.

Folders

Use Folders to organize similar applications together. Tap the folder to open and display items in the folder.

Creating a Folder

To create a folder, there must be at least two app icons on the Home screen.

1. Go to the desired Home screen.
2. Tap and hold on one application icon.
3. Drag the icon and stack on top of another icon.
4. Lift and release.

Naming Folders

1. Touch the folder.



Figure 2-4 *Open Folder*

2. Touch the title area and enter a folder name using the keyboard.
3. Touch **Done**.
4. Touch anywhere on the Home screen to close the folder. The folder name appears under the folder.

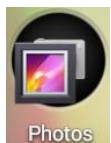



Figure 2-5 *Renamed Folder*

Removing a Folder

1. Tap and hold the folder icon until it enlarges and the device vibrates.
2. Drag the icon to  **Remove** and release.

Home Screen Wallpaper

✓ **NOTE** Use of Live Wallpaper may reduce battery life.

Changing the Home Screen Wallpaper

1. Touch .
2. Touch **Wallpaper**.
3. From the **Choose wallpaper from** menu, touch **Gallery**, **Live Wallpapers** or **Wallpapers**.
 - **Gallery** - Select to use an image stored on the device.
 - **Live Wallpapers** - Select to use an animated wallpaper image.
 - **Wallpapers** - Select to use a wallpaper image.
4. Touch **Save** or **Set wallpaper**.

Stylus and Touchscreen



Use the MC67 stylus to select items and enter information. The stylus functions as a mouse.

- **Touch:** Touch the screen once with the stylus to press option buttons and open menu items.
- **Touch and Hold:** Touch and hold the stylus on an item to see a list of actions available for that item. On the pop-up menu that appears, touch the action to perform.
- **Drag:** Hold the stylus on the screen and drag across the screen to select text and images. Drag in a list to select multiple items.
- **Swipe-** Move stylus up and down or left and right on the screen to:
 - unlock the screen
 - view additional Home screens
 - view additional application icons in the Application window
 - view more information on an application's screen.
- **Double-tap** - Tap twice on a web page, map, or other screen to zoom in and out.



CAUTION To prevent damage to the screen, do not use any device other than the provided stylus.

Using the On-screen Keyboard

Use the on-screen keyboard to enter text in a text field. To configure the keyboard settings, touch  (comma) >  and then select **Android keyboard settings**.



Editing Text

Edit entered text and use menu commands to cut, copy, and paste text within or across applications. Some applications do not support editing some or all of the text they display; others may offer their own way to select text.

Entering Numbers, Symbols and Special Characters

To enter numbers and symbols:

- Touch and hold one of the top-row keys until a menu appears then select a number. Keys with alternate characters display an ellipsis (...) below the character.

- Touch and hold the Shift key with one finger, touch one or more capital letters or symbols to enter them, and then lift both fingers to return to the lowercase keyboard.
- Touch  to switch to the numbers and symbols keyboard.
- Touch the  key on the numbers and symbols keyboard to view additional symbols.

To enter special characters, touch and hold a number or symbol key to open a menu of additional symbols.

- A larger version of the key displays briefly over the keyboard.
- Keys with alternate characters display an ellipsis (...) below the character.

Keypads

The MC67 offers the following keypad configurations: Numeric, alphanumeric (QWERTY, AZERTY, QWERTZ) and Direct Store Delivery (DSD).

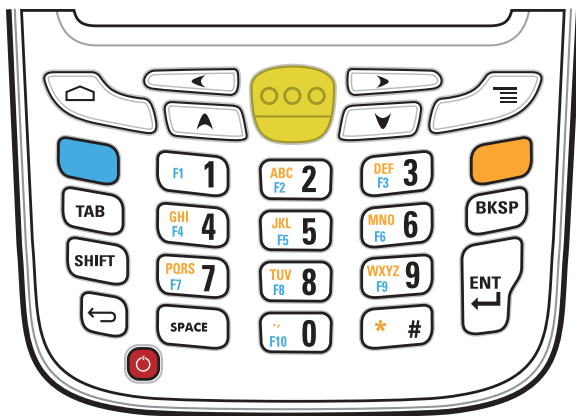

Figure 2-6 MC67 Numeric Keypad

See [Appendix B, Keypads](#) for detailed information on the keypad configurations.

Applications

The **APPS** screen displays icons for all installed applications. The table below lists the applications installed on the MC67. Refer to the *MC67 Integrator Guide* for information on installing and uninstalling application.

Table 2-4 Applications



Icon	Description
	App Gallery – Provides links to utilities and demonstration applications that can be installed on the MC67.
	Battery Management - Displays battery information, including charge level, status, health and wear level.

Table 2-4 Applications (Continued)

Icon	Description
	Bluetooth Pairing Utility – Use to pair the RS507 Hans-free Imager with the MC67 by scanning a bar code.
	Browser - Use to access the Internet or intranet.
	Calculator - Provides the basic and scientific arithmetic functions.
	Calendar - Use to manage events and appointments.
	Camera - Take photos or record videos. For more information see Camera on page 4-4 .
	Clock - Use to schedule alarms for appointments or as a wake-up.
	DataWedge - Enables data capture using the camera or optional scanner.
	Downloads - lists all downloads files.
	DWDemo - Provides a way to demonstrate the data capture features using the Linear Imager or Camera. See DataWedge Demonstration on page 4-15 for more information.
	elemez - Use to provide diagnostic information to us. See Elemesz on page 4-20 for more information.
	Email - Use to send and receive email.
	File Browser - Organize and manage files on the MC67. See File Browser on page 4-1 for more information.
	Gallery - Use to view photos stored on the microSD card. For more information, see Gallery on page 4-8 for more information.

Table 2-4 Applications (Continued)



















Icon	Description
	Messaging - Send SMS messages. Messaging on page 4-2 for more information.
	MLog Manager - Use to capture log files for diagnostics. See MLog Manager on page 4-16 for more information.
	MSP Agent - Enables management of the MC67 from an MSP server. Requires the purchase of an appropriate MSP client license per device to suit the level of management functionality required.
	Music - Play music stored on the microSD card.
	People - Use to manage contact information. People for more information.
	Phone - Use to make phone calls. Calls for more information.
	PTT Express - Use to launch the PTT Express client for Voice over IP (VoIP) communication.
	Rapid Deployment - Allows the MC67 to stage a device for initial use by initiating the deployment of settings, firmware and software. Requires the purchase of an MSP client license per device.
	RxLogger - Use to diagnose device and application issues. See the <i>MC67 with Android™ OS Integrator Guide</i> for more information.
	Search - Use the Google search engine to search the Internet and the MC67.
	Settings - Use to configure the MC67.
	Sound Recorder - Use to record audio.
	StageNow - Allows the MC65 to stage a device for initial use by initiating the deployment of settings, firmware and software.

Table 2-4 Applications (Continued)

Icon	Description
	TechDocs - Opens the on-device User Guide for the MC67.
	Terminal Emulation - Opens Wavelink Terminal Emulation application.
	AppLock Administrator - Use to configure the Application Lock feature. This icon appears after the optional application is installed.
	MultiUser Administrator - Use to configure the MultiUser feature. This icon appears after the optional application is installed.
	Secure Storage Administrator - Use to configure the Secure Storage feature. This icon appears after the optional application is installed.

Accessing Applications

All applications installed on the device are accessed using the **APPS** window.

1. Touch .

**Figure 2-7** APPS Window

2. Slide the **APPS** window left or right to view more application icons. Touch an icon to open the application.
See [Application Shortcuts and Widgets on page 2-6](#) for information on creating a shortcut on the Home screen.

Switching Between Recent Applications

1. Press and hold . A window appears on the screen with icons of recently used applications.



Figure 2-8 *Recently Used Applications*

2. Slide the window up and down to view all recently used applications.
3. Swipe left or right to remove application from the list and force close the application.
4. Touch an icon to open it or press ↶ to return to the current screen.



Un-Locking the Screen

Use the Lock screen to protect access to data on the MC67. Some email account require locking the screen. Refer to the *MC67 Integrator Guide* for information on setting up the locking feature. The Locking feature functions differently in Single User mode or Multiple User mode.

Single User Mode

When locked, a pattern, PIN or password is required to unlock the device. Press the Power button to lock the screen. The device also locks after a pre-defined time-out.

Press and release the Power button to wake the device.

The Lock screen displays. Slide  to the right toward  to unlock the screen.

If the Pattern screen unlock feature is enabled, the Pattern screen appears instead of the Lock screen.

If the PIN or Password screen unlock feature is enabled, enter the PIN or password after unlocking the screen.



Figure 2-9 *Lock Screen*



Figure 2-10 PIN Screen



Figure 2-11 Pattern Screen



Figure 2-12 Password Screen

MultiUser Mode

With MultiUser login, multiple users can log on to the device with each user having access to various applications and features. When enabled, the Login screen appears after powering on, resetting or after the device wakes from suspend mode.

MultiUser Login

1. In the **Login** text field, enter the username.

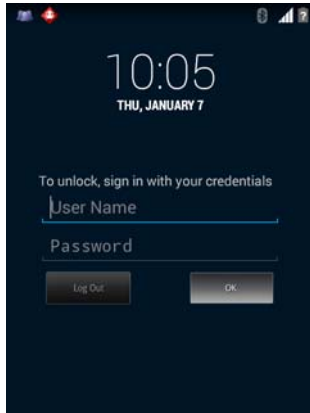

Figure 2-13 Multiple User Log In Screen

2. In the **Password** text field, enter the password.
3. Touch **OK**. After a resume from suspend, the user must enter the password.

MultiUser Logout

1. Drag the Status Bar down from the top of the screen.
2. Touch **MultiUser is active**.
3. Touch **Logout**.
4. The **Login** screen appears.

Resetting the Device

There are two reset functions, soft reset and hard reset.

Performing a Soft Reset

Perform a soft reset if applications stop responding.

1. Press and hold the Power button until the menu appears.
2. Touch **Reset**.
3. The device shuts down and then reboots.
4. The device reboots.

Performing a Hard Reset



CAUTION Performing a hard reset with a SIM card installed in the MC67 may cause damage or data corruption to the SIM card.



Perform a hard reset if the MC67 stops responding.

1. On a numeric or DSD keypad, simultaneously press the Power button and the 1 and 9 keys.
2. On an alpha-numeric keypad, simultaneously press the Power button and the W and C keys.
3. The MC67 shuts down and then reboots.

Suspend Mode

The MC67 goes into suspend mode when the user presses the Power button or after a period of inactivity (set in the Display settings window).

To wake the MC67 from Suspend mode, press the Power button.

The Lock screen displays. Slide  to the right toward  to unlock the screen. If the Pattern screen unlock feature is enabled, the Pattern screen appears instead of the Lock screen. See [Un-Locking the Screen on page 2-13](#).



NOTE If the user enters the PIN, password or pattern incorrectly five times, they must wait 30 seconds before trying again.

If the user forgets the PIN, password or pattern contact the system administrator.



Figure 2-14 Lock Screen

LED Indicators

The MC67 has three light emitting diode (LED) indicators. The Data Capture LED indicates status for scanning. The Charging/Battery Status LED indicates battery charging and status. The Radio Status LED indicates Wide Area Network (WAN) radio status.

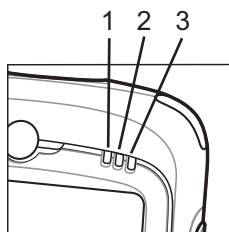

Figure 2-15 LED Indicators

✓ **NOTE** For information about scanning/decoding, see [Chapter 5, Data Capture](#). For information about WAN radio status and settings, see [Chapter 3, Calls](#), or refer to the *MC67 Integrator Guide*.

Figure 2-16 *LED Indications*

LED State	Indication
1 – Data Capture LED	
Solid Green	Successful decode/capture.
Flashing Green	Software initiated notification, such as Email.
Solid Red (after Safe Battery Swap mode)	MC67 is shutting down for battery replacement.
2 – Charging/Battery Status LED	
Slow Blinking Amber	Main battery in MC67 is charging.
Solid Amber	Main battery in MC67 is fully charged.
Fast Blinking Amber	Charging error.
Off	MC67 not charging.
3 – WAN Radio Status LED	
Slow Blinking Green	RF (WAN) radio is on.
Off	RF (WAN) radio is off.

CHAPTER 3 CALLS

Make a phone call from the **Phone** application, the **People** application or other applications or widgets that display contact information.

Emergency Calling

The service provider programs one or more emergency phone numbers, such as 911 or 999, that the user can call under any circumstances, even when the phone is locked, a SIM card is not inserted or the phone is not activated. The service provider can program additional emergency numbers into the SIM card. However, the SIM card must be inserted in the device in order to use the numbers stored on it. See the service provider for additional information.

- ✓ **NOTE** Emergency numbers vary by country. The phone's pre-programmed emergency number(s) may not work in all locations, and sometimes an emergency call cannot be placed due to network, environmental, or interference issues.

Audio Modes

The device offers three audio modes for use during phone calls:

- **Handset Mode:** Switches audio to the receiver at the top front of the device, so the user can use the device as a handset. This is the default mode.
- **Speaker Mode:** Use the device as if on speaker phone.
- **Headset Mode:** Connect a Bluetooth or wired headset to automatically switch audio to the headset.
- **Headset Mode:** Connect a Bluetooth to automatically switch audio to the headset.

Using a Bluetooth Headset

Use a Bluetooth headset for audio communication when using an audio-enabled application. See Bluetooth for information on connecting a Bluetooth headset to the device. Set the volume appropriately before putting on the headset. When a Bluetooth headset is connected, the speakerphone is muted.



Adjusting Audio Volume

Use the Volume buttons to adjust the volume of the ringer when not in a call and the audio volume when in a call.

- ✓ **NOTE** Adjust the conversation phone volume during a call. Adjusting the volume while not in a call affects the ring and notification sound levels.

Making a Call Using the Dialer

Use the dialer tab to dial phone numbers.

1. On the Home screen touch .
2. Touch .

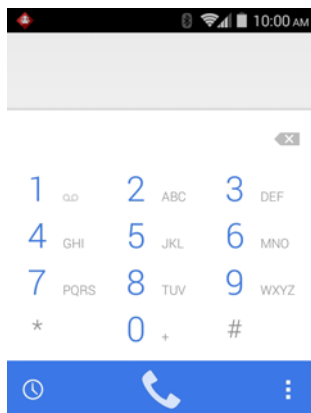



Figure 3-1 *Dialer Screen*

3. Touch the keys to enter the phone number.
4. Touch  below the dialer to initiate the call.

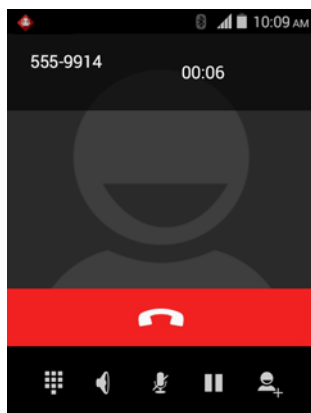







Figure 3-2 *Call in Progress*

If	Then
You want to display the dialer.	Touch  .
You want to turn on the speakerphone.	Touch  .
You want to mute the call.	Touch  .
You want to place the call on hold.	Touch  .
You want to add another person to the call.	Touch  .

- Touch  to end the call.

Making a Call Using Contacts

- On the Home screen touch  .
- Touch a contact from the list.
- Touch phone number to initiate call.

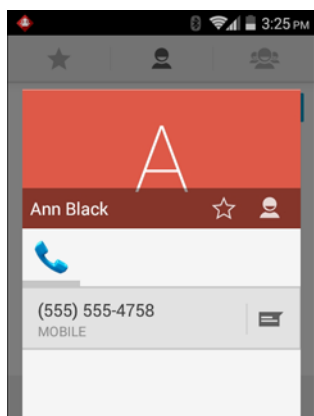





Figure 3-3 *Dialer Contacts Tab*

- Touch the contact to initiate the call.
- Touch  to end the call.

Making a Call Using Call History

Call History is a list of all the calls placed, received, or missed. It provides a convenient way to redial a number, return a call, or add a number to Contacts.

1. On the Home screen touch .
2. Touch .

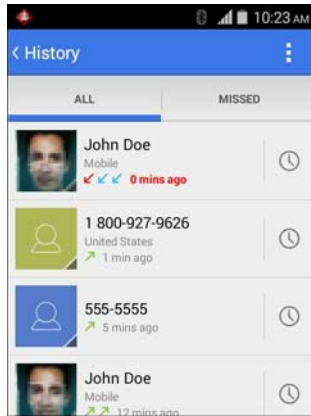





Figure 3-4 Call History Tab

Arrow icons beside a call indicate the type of call. Multiple arrows indicate multiple calls:





-  - Missed incoming call
-  - Received incoming call
-  - Outgoing call.

3. Touch contact to initiate the call.

Making a Conference Call

To create a conference phone session with multiple people.

- ✓ **NOTE** Conference Calling and the number of conference calls allowed may not be available on all services. Please check with the service provider for Conference Calling availability.

1. On the Home screen touch .
2. Touch .
3. Touch the keys to enter the phone number.
4. Touch  below the dialer to initiate the call.
5. When the call connects, touch .
The first call is placed on hold.
6. Touch the keys to enter the second phone number.
7. Touch  below the dialer to initiate the call.
8. When the call connects, the first call is placed on hold and the second call is active.

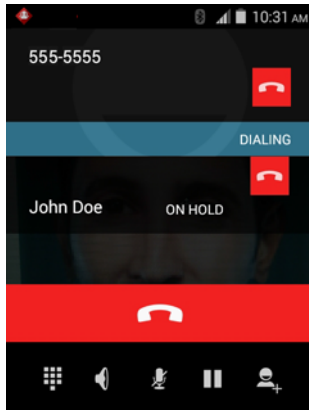



Figure 3-5 *Two Calls*

9. Touch  icon to create a conference call with three people.

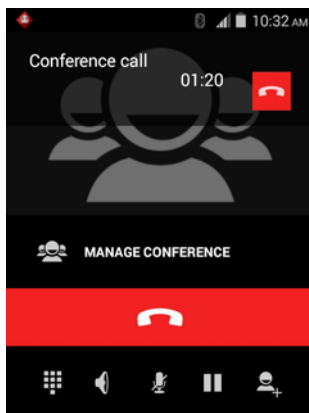





Figure 3-6 *Merged Calls*

10. Touch  to add another call.
The conference is placed on hold.
11. Touch the keys to enter the second phone number.
12. Touch  below the dialer to initiate the call.
13. Touch  icon to add the third call to the conference.
14. Touch **Manage Conference** to view all callers.

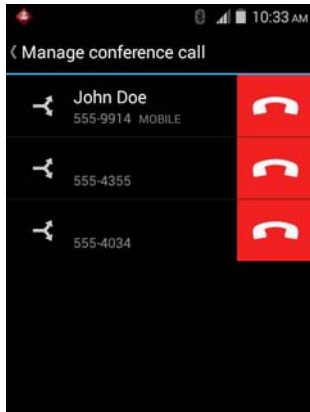





Figure 3-7 *Un-merge Calls*

15. To remove a caller from the conference, touch  next to the caller.

To speak privately with one party during a conference call, touch Manage Conference and then touch the caller. To include all parties again, touch .

Making a Call Using a Bluetooth Headset

1. Pair the Bluetooth headset with the device.
2. On the Home screen touch .
3. Touch .
4. Touch the keys to enter the phone number.
5. Touch  below the dialer to initiate the call.
6. Press the Call button on the Bluetooth headset to end the call.

Answering Calls

When you receive a phone call, the Incoming Call screen opens, displaying the caller ID and any additional information about the caller that is in the People application.





Figure 3-8 *Incoming Call Screen*

All incoming calls are recorded in the Phone application Call log tab. If you miss a call, you receive a notification. To silence the ringer before answering the call, press the volume down button on the side of device.

When a call arrives, touch the white phone icon and slide over one of these icons:



Figure 3-9 *Select Answer Options*

-  Answer call - Start talking to the caller.
-  Send to voice mail - Direct the caller to leave a voice mail message.
-  Send a message - Opens a list of quick text responses. Touch one to send it to the caller immediately.

Answering Calls with a Bluetooth Headset

When you receive a phone call, the Incoming Call screen opens, displaying the caller ID and any additional information about the caller that is in the People application.



Figure 3-10 Incoming Call Screen

All incoming calls are recorded in the Phone application Call log tab. If you miss a call, you receive a notification. To silence the ringer before answering the call, press the volume down button on the side of the device.

When a call arrives, touch the Call button on the Bluetooth headset to answer the call.

To end the call press the Call button on the Bluetooth headset.

Call Settings

✓ **NOTE** Not all options are available for all configurations.

Use the Call Settings to modify options related to the phone call feature.

- **Ringtone & Vibrate**
 - **Phone ringtone** - Touch to select a ringtone to sound when an incoming call is received.
 - **Vibrate when ringing** - Check to make the device vibrate when a call is received.
- **Other Call Settings**
 - **Voicemail** - Touch to configure voicemail settings.
 - **Service** - Set the service provider or other provider for voicemail service.
 - **Setup** - Touch to update the phone number used to access voicemail.
 - **Sound** - Touch to select a ringtone to sound when a voicemail is received.
 - **Vibrate** - Touch to select vibrate option.
 - **Dial pad touch tones** - Check to play a sound when a phone key is touched.
 - **Quick responses** - Touch to edit quick responses to use instead of answering a call.
 - **Fixed Dialing Numbers** - Use Fixed Dialing to restrict the phone to dial only the phone number(s) or area code(s) specified in a Fixed Dialing list.
 - **Call forwarding** - Use call forwarding to forward incoming calls to a different phone number.

✓ **NOTE** Call Forwarding may not be available on all networks. Check with the service provider for availability.

- **Always forward** - set to forward all calls to a different phone number.
- **Forward when busy** - enter the phone number to forward calls only when the line is busy.

- **Forward when unanswered** - enter the phone number to forward calls only when the phone cannot be answered.
- **Forward when unreachable** - enter the phone number to forward calls only when the phone is turned off or the user is unreachable.
- **Call barring** - Use call barring to block certain types of incoming and/or outgoing calls. Select the type of incoming and/or outgoing calls to block.
- **Additional settings**
 - **Caller ID** - Enable caller ID to reveal the identity of the person making an outgoing call. Options: **Network default** (default), **Hide number**, **Show number**.
 - **Call waiting** - Check to enable.
- **Internet Call Settings**
 - **Accounts** - Choose to receive Internet calls for accounts added to the device, view or change SIP accounts, or add an Internet calling account.
 - **Use Internet calling** - Use Internet calling for all calls, only for calls to Internet calling addresses (the default setting), or to ask for each call. Must be connected to a Wi-Fi network and have added an Internet calling account to the device to use Internet calling.

CHAPTER 4 APPLICATIONS

This section describes the applications installed on the device.

File Browser

Use the **File Browser** application to view and manage files on the device.

To open **File Browser**, touch  > .





Figure 4-1 *File Browser Screen*

The address bar (1) indicates the current folder path. Touch the current folder path to manually enter a path and folder name.

Use  to select multiple files/folder.

Use  to view the internal storage root folder.

Use  to view the microSD card root folder.

Use  to view the previous folder or to exit the application.

Touch and hold an item to perform an operation on that item. Select one of the options from the **File Operations** menu:

- **Information** - View detailed information about the file or folder.

- **Move** - Move the file or folder to a new location.
- **Copy** - Copy the select file.
- **Delete** - Delete the selected file.
- **Rename** - Rename the select file.
- **Open as** - Open the selected file as a specific file type.
- **Share** - Share the file with other devices.

Messaging

Use Messaging to send and receive SMS and MMS messages. From the All Apps screen, touch .

Sending a Text Message

1. In the main Messaging screen, touch .

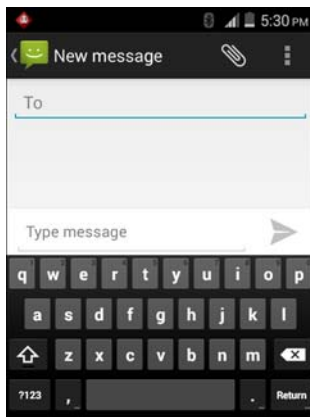



Figure 4-2 *New Text Message Screen*

2. In the **To** field, enter a name or a mobile phone number.
3. In the **Type message** field, enter the text message.

The 160-character limit counter indicates how many characters are left. If it goes over that limit, a new message is created, which is joined with its predecessors when received.

If the user presses the Back button while composing a message, it's saved as a draft in the Messaging screen. Touch the conversation to resume composing it.

4. Touch  to send the message.

People



Use the **People** application to manage contacts.

From a Home or Apps screen, touch . People opens to the main list of contacts. View contacts in three ways at the top of the screen: Groups, All contacts, and Favorites. Touch the tabs to change how to view the contacts. Swipe up or down to scroll through the lists.



Adding People

1. In the People application, touch .
2. If there are more than one account with contacts, touch the one to use.
3. Type the contact's name and other information. Touch a field to start typing, and swipe down to view all categories.
4. To add more than one entry for a category – for example, to add a work address after typing a personal address – touch **Add new** for that field. To open a menu with preset labels, such as Home or Work for an email address, touch the label to the right of the item of contact information. Or, to create your own label, touch **Custom** in the menu.
5. Touch **Done**.

Editing People

1. In the People application, touch  tab.
2. Touch a person to edit.
3. Press .
4. Touch **Edit**.
5. Edit the contact information.
6. Touch **Done**.

Deleting People

1. In the People application, touch  tab.
2. Touch a person to edit.
3. Press .
4. Touch **Delete**.
5. Touch **OK** to confirm.

Camera

This section provides information for taking photos and recording videos using the integrated digital cameras.

Taking Photos

✓ **NOTE** Camera settings are described in [Camera Settings on page 4-6](#).

To take a photo:

1. Touch  > .

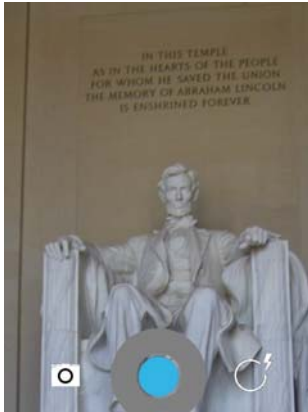









Figure 4-3 Camera Mode

2. If necessary, touch the options bar and touch .
3. Touch  >  to adjust exposure, flash, and other settings using the camera settings.
4. Frame the subject on screen.
5. Use the Volume Up and Volume Down buttons to zoom in or out.
6. Touch .

The camera brings the image into focus. When the image is in focus, the focus indicators turn green, the camera takes a photo and a shutter sound plays.

✓ **NOTE** To disable the shutter sound, turn notification sounds off. Touch  >  **Sounds** > **Volumes** and slide the **Notifications** slider all the way to the left.

Alternately, touch  and hold to focus first, before taking a photo; then release to take a focused photo. The photo appears momentarily then displays as a thumbnail in the upper right corner.

7. Touch the thumbnail to view the photo in Gallery. See [Gallery on page 4-8](#) for more information.

Taking a Panoramic Photo

Panorama mode lets the user create a single wide image by panning slowly across a scene.





1. Touch  > .
2. Touch the options bar and touch .



Figure 4-4 *Panoramic Mode*

3. Frame one side of the scene to capture.
4. Touch  and slowly start panning across the area to capture. A small white square appears inside the button the shot is in progress.
If panning too quickly, the message **Too fast** appears.
5. Touch  to end the shot. The panorama appears immediately and a progress indicator displays while it saves the image.
6. Touch the thumbnail to view the photo in Gallery. See [Gallery on page 4-8](#).

Recording Videos

To record a video:







1. Touch  > .
2. Touch the options bar and touch .



Figure 4-5 *Video Mode*

3. Touch  >  to adjust exposure, flash, and other settings using the video settings. See [Video Settings on page 4-7](#) for more information.
4. Point the camera and frame the scene.
5. Touch  to start recording.
The device starts recording the video. The video time remaining appears in the top left of the screen.
6. Touch  to end recording.
Recorded video displays in the thumbnail at the top right.
7. Touch the thumbnail to access the Gallery application. See [Gallery on page 4-8](#).

Camera Settings

























When in Camera mode, Camera settings are displayed on screen. Touch  to display the camera setting options.



Figure 4-6 Camera Settings

-  **Exposure** - Touch to adjust the exposure settings. Options: **+3**, **+2**, **+1**, **0** (default), **-1**, **-2**, or **-3**.
-  More Options
 -  **Location** - Include location information with each photo using the device global positioning system (GPS). Options: **On** or **Off** (default).
 -  **Countdown Timer** -
 -  **Picture size** - **QVGA**, **VGA**, **1M pixels**, **1.3M pixels**, **2M pixels (16:9)**, **2M pixels**, **3M pixels**, **5M pixels** or **8M pixels** (default).
 - CAF (Focus Mode) - Touch to select the camera focus setting. Options: **AF Auto** (default),  **Infinity**,  **Macro** or CAF **Continuous**.
 -  **White balance** - Touch to select how Camera adjusts colors in different kinds of light, to achieve the most natural-looking colors.
 -  **Auto** - Adjust the white balance automatically (default).
 -  **Incandescent** - Adjust the white balance for incandescent lighting.
 -  **Sunlight** - Adjust the white balance for daylight.
 -  **Fluorescent** - Adjust the white balance for florescent lighting.

-  **Cloudy** - Adjust the white balance for a cloudy environment.
- **SCE Scene mode** - Touch to select a preset combination of camera settings designed for specific scenes. Options:  **Sports**,  **Night**,  **None** (default),  **Sunset** or  **Party**.
-  **Picture quality** - Touch to select picture quality setting. Options: **Normal**, **Fine** or **Super fine** (default).
-  **Flash mode** - Touch to set whether Camera relies on its light meter to decide whether a flash is necessary, or to turn it on or off for all shots.
 -  **Off** - Disable flash (default).
 -  **Auto** - Camera adjusts flash automatically depending upon light meter.
 -  **On** - Enable flash upon taking a photo.

Video Settings

When in Video mode, Video settings are displayed on screen. Touch  to display the video setting options.

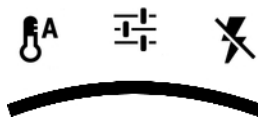











Figure 4-7 Video Settings

-  **White balance** - Touch to select how Camera adjusts colors in different kinds of light, to achieve the most natural-looking colors.
 -  **Incandescent** - Adjust the white balance for incandescent lighting.
 -  **Fluorescent** - Adjust the white balance for florescent lighting.
 -  **Auto** - Adjust the white balance automatically (default).
 -  **Sunlight** - Adjust the white balance for daylight.
 -  **Cloudy** - Adjust the white balance for a cloudy environment.
-  **Settings** - Touch to open a list of settings:
 - **Time lapse interval** - Touch to open a dialog box and select a time interval to set the frame rate for time lapse photography. (Default - Off)
 - **Video quality** - Touch to select video quality:
 - **HD 1080p** - High definition 1080p.
 - **HD 720p** - High definition 720p.
 - **SD 480p** - Standard definition 480p.
 - **Store location** - Include location information with each photo using the device global positioning system (GPS). Options: **On** or **Off** (default).

-  **Flash mode** - Touch to set whether Rear-facing Camera relies on its light meter to decide whether a flash is necessary, or to turn it on or off for all shots.
 -  **On** - Enable flash upon taking a photo.
 -  **Off** - Disable flash (default).

Gallery





NOTE The device supports the following image formats: jpeg, gif, png and bmp.

The device supports the following video formats: H.263, H.264 and MPEG4 Simple Profile.

Use Gallery to:

- view photos
- play videos
- perform basic editing of photos
- set photos as wallpaper
- set photos as a contact photo
- share photos and videos.

To open the Gallery application, touch  >  or in the camera application touch the thumbnail image at the top right.

Gallery presents all photos and videos stored on the microSD card and internal memory.

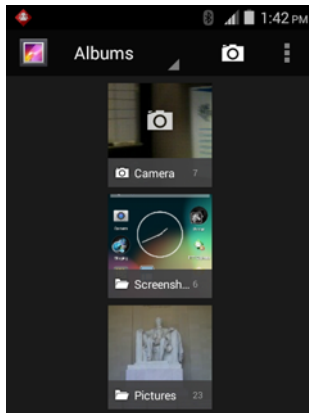



Figure 4-8 Gallery — Albums

- Touch an album to open it and view its contents. The photos and videos in the album are displayed in chronological order.
- Touch a photo or video in an album to view it.
- Touch  icon (top left corner) to return to the main **Gallery** screen.
- Touch  to return to the main **Gallery** screen.

Working with Albums

Albums are groups of images and videos in folders. Touch an album to open it. The photos and videos are listed in a chronologically ordered grid. The name of the album displays at the top of the screen.

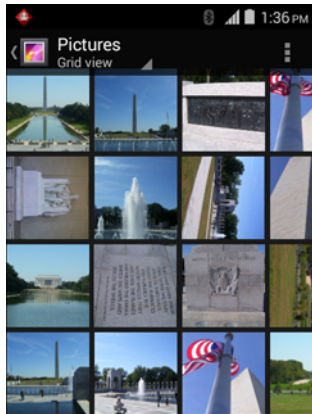







Figure 4-9 *Photos Inside an Album*

Swipe left or right to scroll images across the screen.

Share an Album



1. Touch .
2. Touch .
3. Touch and hold an album until it highlights.
4. Touch other albums as required.
5. Touch . The Share menu opens. Touch the application to use to share the selected albums.
6. Follow the instructions within the selected application.

Get Album Information

1. Touch  > .
2. Touch and hold an album until it highlights.
3. Touch .
4. Touch **Details**.

Deleting an Album

To delete an album and its contents from the microSD card:

1. Touch  > .
2. Touch and hold an album until it highlights.
3. Check other albums to delete. Ensure that other albums are selected.

4. Touch .
5. In the **Delete selected item?** menu, touch **OK** to delete the album.

Working with Photos

Use Gallery to view photos on the microSD card and edit and share photos.

Viewing and Browsing Photos

To view a photo:



1. Touch  > .
2. Touch an album to open it.
3. Touch a photo.



Figure 4-10 *Photo Example*

4. Swipe left or right to view the next or previous photo in the album.
5. Turn the device to view the photo in upright (portrait) or sideways (landscape) orientation. The photo is displayed (but not saved) in the new orientation.
6. Touch the photo to view the controls.
7. Double-tap the screen to zoom in.
8. Drag the photo to view parts that are not in view.

Rotating a Photo

1. Touch a photo to view the controls.
2. Press .
3. Touch **Rotate Left** or **Rotate Right**.
The photo is automatically saved with the new orientation.

Cropping a Photo

1. In Gallery, touch a photo to view the controls.

2. Touch .
3. Touch **Crop**. The white cropping tool appears.
4. Use the cropping tool to select the portion of the photo to crop.
 - Drag from the inside of the cropping tool to move it.
 - Drag an edge of the cropping tool to resize it to any proportion.
 - Drag a corner of the cropping tool to resize it with fixed proportions.



Figure 4-11 *Cropping Tool*

5. Touch **Save** to save a copy of the cropped photo. The original version is retained.

Edit a Photo

✓ **NOTE** When editing a photo, use stylus to select on-screen edit options.

To edit a photo:







1. Touch  > .
2. Touch an album to open it.
3. Touch the photo to edit.
4. Touch  > **Edit**.
5. Use the on-screen options to edit the photo.





Figure 4-12 *Edit Photo*

6. Touch **Save** when done.

Setting a Photo as a Contact Icon

1. Touch  > .
2. Touch an album to open it.
3. Touch the photo to open it.
4. Touch .
5. Touch **Set picture as**.
6. Touch **Contact photo**.
7. In the People application, touch a contact.
8. Touch the blue box and crop the photo accordingly.
9. Touch **OK**.

Get Photo Information



1. Touch  > .
2. Touch an album to open it.
3. Touch the photo to open it.
4. Touch .
5. Touch **Details**.
6. Touch **Close**.

Share a Photo

1. Touch  > .
2. Touch an album to open it.

3. Touch a photo to open it.
4. Touch .
5. Touch the application to use to share the selected photo. The application selected opens with the photo attached to a new message.



Deleting a Photo

1. Touch  > .
2. Touch an album to open it.
3. Touch a photo to open it.
4. Touch .
5. Touch **Delete**.
6. Touch **OK** to delete the photo.

Working with Videos

Use Gallery to view videos on the microSD card and share videos.

Watching Videos

1. Touch  > .
2. Touch an album to open it.
3. Touch a video.

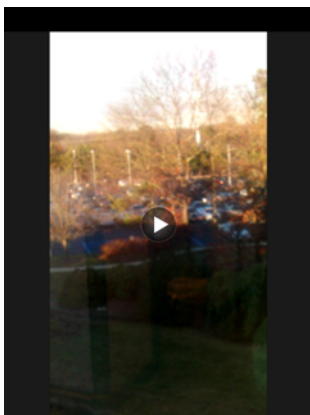



Figure 4-13 *Video Example*



4. Touch . The video begins to play.
5. Touch the screen to view the playback controls.

Sharing a Video

1. Touch  > .

2. Touch an album to open it.
3. Touch a video to open it.
4. Touch . The Share menu appears.
5. Touch the application to use to share the selected video. The application selected opens with the video attached to a new message.

Deleting a Video

1. Touch  > .
2. Touch an album to open it.
3. Touch a video to open it.
4. Touch .
5. Touch **Delete**.
6. Touch **OK**.

DataWedge Demonstration

Use DataWedge Demonstration to demonstrate data capture functionality.

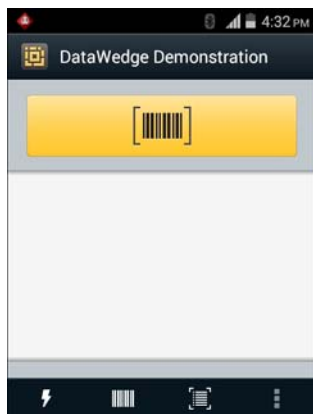

Figure 4-14 *DataWedge Demonstration Window*

Table 4-1 *DataWedge Demonstration Icons*

Icon	Description
	Toggles the flash on and off when using the camera to capture bar code data. Use the flash in dimly lit areas.
	Toggles the data capture function between the internal imager, internal camera or RS507 Hands-free Bluetooth imager (if connected).
	Toggles between normal scan mode and picklist mode when using the camera to capture bar code data.
	Opens a menu to view the application information or to set the application DataWedge profile.

✓ **NOTE** See the *MC67 Integrator Guide* for information on DataWedge configuration.

Either press a Scan key or touch the yellow scan button in the application to enable data capture. The captured data appears in the text field below the yellow button.

Sound Recorder

Use Sound Recorder to record audio messages.

Recordings are saved in the root directory of Internal Storage.

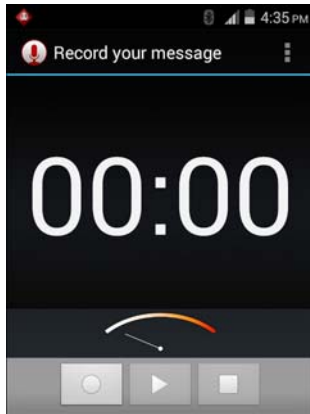

Figure 4-15 *Sound Recorder Application*

MLog Manager

Use MLog Manager to capture log files for diagnostics. See the *MC67 Integrator Guide* for detailed information on configuring the application.

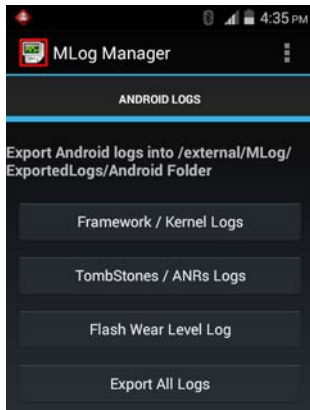

Figure 4-16 *MLog Manager*

PTT Express Voice Client

✓ **NOTE** PTT Express Voice Client creates Push-To-Talk (PTT) communication capability between disparate enterprise devices. Leveraging existing Wireless Local Area Network (WLAN) infrastructure, PTT Express delivers simple PTT communication without the need of a voice communication server.

- **Group Call:** Press and hold the PTT (Talk) button to start communicating with other voice client users.

PTT Audible Indicators

The following tones provide helpful cues when using the voice client.

- **Talk Tone:** Double chirp. Plays when the Talk button is depressed. This is a prompt for the user to start talking.
- **Access Tone:** Single beep. Plays when another user just finished a broadcast or response. The user is now able to initiate a Group Broadcast or Private Response.
- **Busy Tone:** Continuous tone. Plays when the Talk button is depressed and another user is already communicating on the same talkgroup. Plays after the maximum allowed talk time is reached (60 seconds).
- **Network Tone:**
 - Three increasing pitch beeps. Plays when PTT Express has acquired the WLAN connection and the service is enabled.
 - Three decreasing pitch beeps. Plays when PTT Express has lost the WLAN connection or the service is disabled.

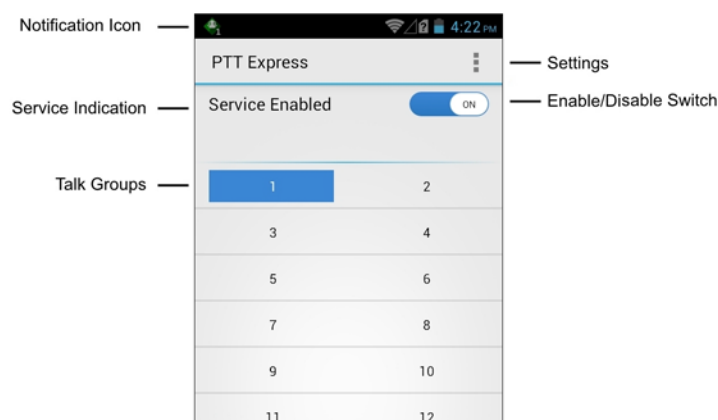

Figure 4-17 PTT Express Default User Interface







Table 4-2 PTT Express Default User Interface Descriptions

Item	Description
Notification Icon	Indicates the current state of the PTT Express client.
Service Indication	Indicates the status of the PTT Express client. Options: Service Enabled , Service Disabled or Service Unavailable .
Talk Groups	Lists all 32 Talk Groups available for PTT communication.
Settings	Opens the PTT Express Settings screen.
Enable/Disable Switch	Turns the PTT service on and off.

Notification Icons

Indicates the current state of the PTT Express Voice client.

Table 4-3 PTT Express Default User Interface Descriptions

Status Icon	Description
	Indicates that PTT Express Voice client is disabled.
	Indicates that PTT Express Voice client is enabled but not connected to a WLAN.
	Indicates that PTT Express Voice client is enabled, connected to a WLAN and listening on the Talk Group indicated by the number next to the icon.
	Indicates that PTT Express Voice client is enabled, connected to a WLAN and communicating on the Talk Group indicated by the number next to the icon.
	Indicates that PTT Express Voice client is enabled, connected to a WLAN and in a private response.
	Indicates that PTT Express Voice client is enabled and muted.
	Indicates that the PTT Express Voice client is enabled but it is not able to communicate due to a VoIP telephony call is in progress.

Enabling PTT Communication

1. Touch  > .
2. Slide the **Enable/Disable Switch** to the **ON** position. The button changes to an **ON** button.

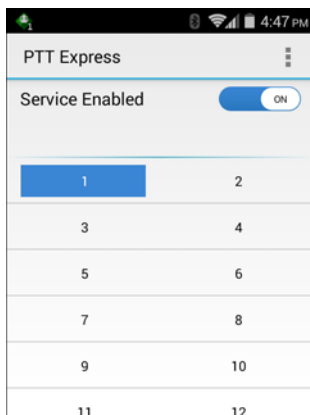

Figure 4-18 PTT Express Window

Selecting a Talk Group

One of 32 Talk Groups can be selected by PTT Express users. However, only one talk group may be enabled at a time on the device. Touch one of the 32 Talk Groups. The selected Talk Group is highlighted.

PTT Communication

- ✓ **NOTE** This section describes the default PTT Express client configuration. See the *PTT Express V1.2 User Guide* for detailed information on using the client.

PTT communication may be established as a Group Call. When PTT Express is enabled, the bottom button on the right side of the device are assigned for PTT communication.

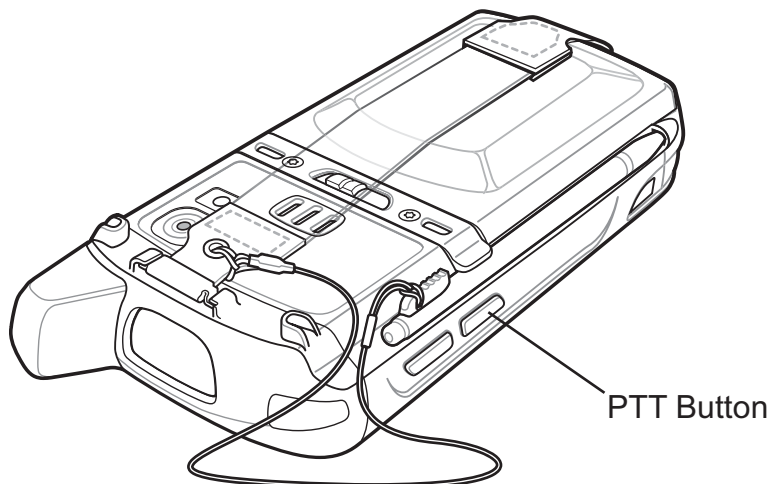

Figure 4-19 MC67 PTT Button Location

Creating a Group Call

1. Press and hold the button and listen for the talk tone to play.
If a busy tone is heard, release the button and wait a moment before making another attempt. Ensure that PTT Express and the WLAN are enabled.
2. Start talking after the talk tone is heard.

- ✓ **NOTE** If the user holds the button for more than 60 seconds (default), the call is dropped allowing others to make Group calls. The user should release the button when finished talking to allow others to make calls.

3. Release the button when finished talking.

Disabling PTT Express Voice Client Communication

1. Touch  > .
2. Slide the **Enable/Disable Switch** to the **OFF** position. The button changes to **OFF**.
3. Touch .

Elemez



NOTE Elemez collects specific device information in the background and sends this information to us to help improve product functionality. This feature can be disabled. See [Disabling Elemez Data Collection](#).

Ensure that the date, time and time zone are set correctly prior to using Elemez.

Use Elemez to provide diagnostics information to Zebra. Touch **Enable Elemez** to enable the application.

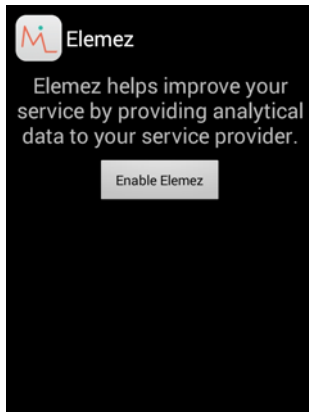

Figure 4-20 *Elemez Application*

Touch **Submit Diagnostics** button to send the data.

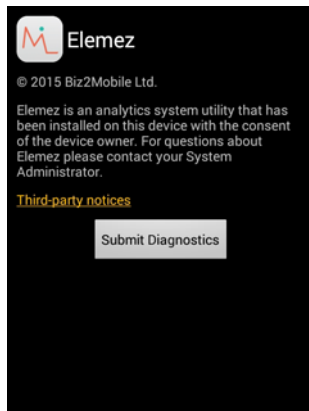



Figure 4-21 *Elemez Submit Diagnostics Data*

Disabling Elemez Data Collection





The user can disable the Elemez application from collection specific data in the background and sending it to Zebra Technologies.

1. From the Home screen, touch
2. Touch **Manage Apps**.
3. Swipe left or right until the **ALL** tab displays.
4. Scroll through the list and touch **Elemez**.

5. In the **App info** screen, touch **Uninstall updates**.
6. In the **Uninstall updates** dialog box, touch **OK**.
7. Touch **OK**.
8. After uninstall is complete, touch **OK**.
9. In the **All** tab, scroll through the list and touch **Elemesz**.
10. Touch **Disable**.
11. In the **Disable built-in app?** dialog box, touch **OK**.
12. Touch .

Enabling Elemesz Data Collection

The user can re-enable the Elemesz application for collection specific data in the background and sending it to Zebra Technologies.

1. From the Home screen, touch .
2. Touch **Manage Apps**.
3. Swipe left or right until the **ALL** tab displays.
4. Scroll through the list and touch **Elemesz**.
5. In the **App info** screen, touch **Enable**.
6. Touch .
7. Touch .
8. Touch .
9. Touch **Enable Elemesz**.

CHAPTER 5 DATA CAPTURE

The MC67 offers the following types of data capture options:

- Imaging
- Digital camera
- RS507 Hands-free Imager.



NOTE By default, the good decode beep is set to system volume (Music and Media). The good decode beep can be set to another sound (Notifications or Alarms) and the volume can be independently controlled. See the *DataWedge* section in the *MC67 Integrator Guide* for more information.

DataWedge is installed and enabled on the MC67 by default.

Imaging

The MC67 with an integrated 2D imager has the following features:

- Omnidirectional reading of a variety of bar code symbologies, including the most popular linear, postal, PDF417, and 2D matrix code types.
- The ability to capture and download images to a host for a variety of imaging applications.
- Advanced intuitive laser aiming cross-hair and dot aiming for easy point-and-shoot operation.

The imager uses imaging technology to take a picture of a bar code, stores the resulting image in its memory, and executes state-of-the-art software decoding algorithms to extract the bar code data from the image.

Operational Modes

The MC67 with an integrated imager supports three modes of operation, listed below. Activate each mode by pressing the Scan button.

- **Decode Mode:** In this mode, the MC67 attempts to locate and decode enabled bar codes within its field of view. The imager remains in this mode as long as the user holds the scan button, or until it decodes a bar code.

✓ **NOTE** To enable Pick List Mode, configure in DataWedge or set in an application using a API command.

- **Pick List Mode:** This mode allows the user to selectively decode a bar code when more than one bar code is in the MC67's field of view. To accomplish this, move the aiming crosshair or dot over the required bar code to decode only this bar code. This feature is ideal for pick lists containing multiple bar codes and manufacturing or transport labels containing more than one bar code type (either 1D or 2D).
- **Image Capture Mode:** Use this mode to capture an image within the MC67's field of view. This is useful for capturing signatures or images of items like damaged boxes.

Digital Camera

The MC67 with an integrated camera based bar code scanning solution has the following features:

- Omnidirectional reading of a variety of bar code symbologies, including the most popular linear, postal, PDF417, and 2D matrix code types
- Advanced intuitive aiming for easy point-and-shoot operation
- Taking photos and recording videos.

The solution uses the advanced camera technology to take a digital picture of a bar code, and executes state-of-the-art software decoding algorithms to extract the data from the image.

Scanning Considerations

Typically, scanning is a simple matter of aim, scan, and decode and a few quick trial efforts master it. However, consider the following to optimize scanning performance:

- **Range:** Any scanning device decodes well over a particular working range — minimum and maximum distances from the bar code. This range varies according to bar code density and scanning device optics. Scanning within range brings quick and constant decodes; scanning too close or too far away prevents decodes. Move the scanner closer and further away to find the right working range for the bar codes being scanned.
- **Angle:** Scanning angle is important for promoting quick decodes. When laser beams reflect directly back into the scanner from the bar code, this specular reflection can “blind” the scanner. To avoid this, scan the bar code so that the beam does not bounce directly back. But don't scan at too sharp an angle; the scanner needs to collect scattered reflections from the scan to make a successful decode. Practice quickly shows what tolerances to work within.
- Hold the MC67 farther away for larger symbols
- Move the MC67 closer for symbols with bars that are close together.

✓ **NOTE** Scanning procedures depend on the application and MC67 configuration. An application may use different scanning procedures from the one listed above.

Imager Scanning

To read a bar code, a scan-enabled application is required. The MC67 contains the DataWedge application that allows the user to enable the imager, decode the bar code data and display the bar code content.

1. Ensure that an application is open on the MC67 and a text field is in focus (text cursor in text field).
2. Point the exit window on the top of the MC67 at a bar code.

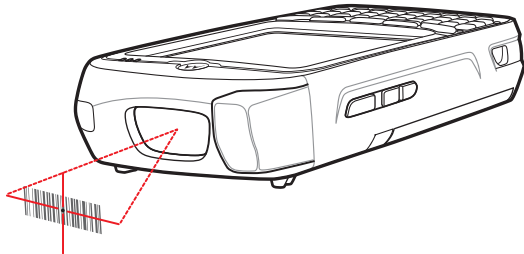

Figure 5-1 *Imager Scanning*

3. Press and hold the scan button.

The red laser aiming pattern turns on to assist in aiming.

✓ **NOTE** When the MC67 is in Picklist mode, the imager does not decode the bar code until the crosshair or aiming dot touches the bar code.

4. Ensure the bar code is within the area formed by the crosshairs in the aiming pattern. The aiming dot is used for increased visibility in bright lighting conditions.

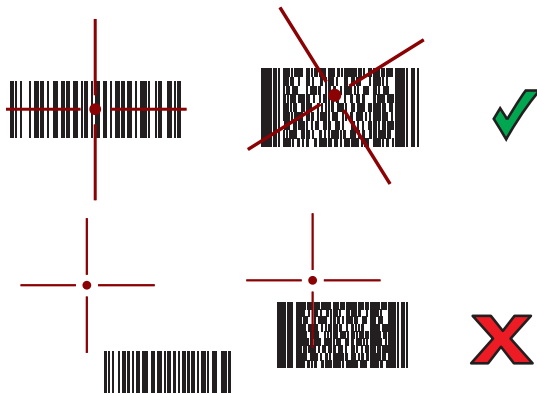

Figure 5-2 *Aiming Pattern*



Figure 5-3 *Pick List Mode with Multiple Bar Codes in Aiming Pattern*

5. The Data Capture LED lights green and a beep sounds, by default, to indicate the bar code was decoded successfully.
6. Release the scan button.

✓ **NOTE** Imager decoding usually occurs instantaneously. The MC67 repeats the steps required to take a digital picture (image) of a poor or difficult bar code as long as the scan button remains pressed.

7. The bar code content data displays in the text field.

Digital Camera Scanning

To read a bar code, a scan-enabled application is required. The MC67 contains the DataWedge application that allows the user to enable the camera, decode the bar code data and display the bar code content.

1. Ensure that an application is open on the MC67 and a text field is in focus (text cursor in text field).
2. Point the camera lens on the back of the MC67 at a bar code.



Figure 5-4 Camera Scanning

3. Press and hold a scan button.
A preview window appears on the display window.

✓ **NOTE** When Picklist mode is enabled, move the MC67 until the bar code is centered under the red target on the screen.

4. Move the MC67 until the bar code is visible on the screen.
5. The Data Capture LED lights green and a beep sounds, by default, to indicate the bar code was decoded successfully.
6. The bar code content data displays in the text field.

Bar Code Capture with RS507 Hands-Free Imager

Pair the RS507 with the MC67. See [Pairing the RS507 Hands-Free Imager Using SSI on page 5-5](#) or [Pairing the RS507 Hands-Free Imager Bluetooth HID on page 5-6](#) for more information.

1. Ensure that an application is open on the device and a text field is in focus (text cursor in text field).

2. Point the RS507 at a bar code.

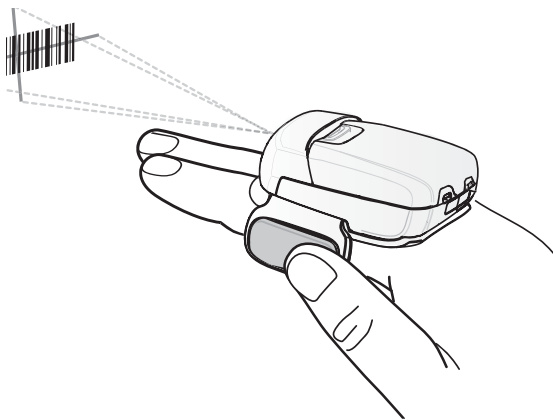

Figure 5-5 Bar Code Scanning with RS507

3. Press and hold the trigger.

The red laser aiming pattern turns on to assist in aiming. Ensure the bar code is within the area formed by the cross-hairs in the aiming pattern. The aiming dot is used for increased visibility in bright lighting conditions.

The RS507 LEDs light green, a beep sounds to indicate the bar code was decoded successfully. Note that when the RS507 is in Pick List Mode, the RS507 does not decode the bar code until the center of the crosshair touches the bar code.

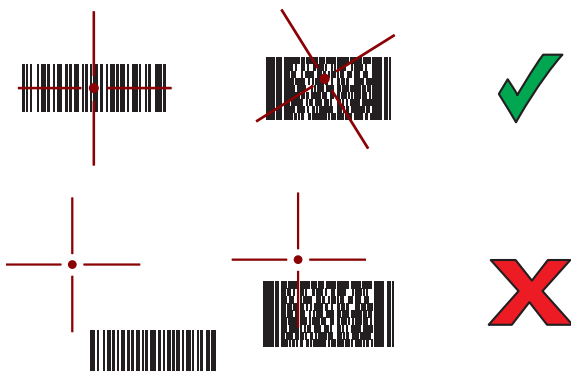

Figure 5-6 Aiming Pattern





Figure 5-7 Pick List Mode with Multiple Bar Codes in Aiming Pattern

4. The captured data appears in the text field.

Pairing the RS507 Hands-Free Imager Using SSI

An RS507 Hands-free Imager can be used with the device to capture bar code data.

1. Ensure that the two devices are within 10 meters (32.8 feet) of one another.
2. Install the battery into the RS507.
3. On the MC67, touch  > .

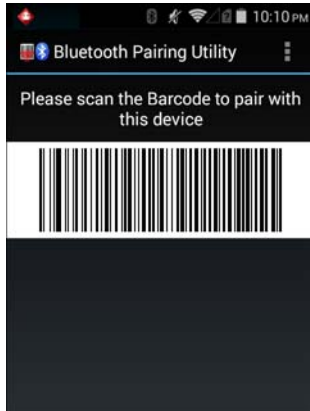



Figure 5-8 *Bluetooth Pairing Utility*

4. Using the RS507, scan the bar code on the screen.
The RS507 emits a high/low/high/low beeps. The Scan LED flashes green indicating that the RS507 is attempting to establish connection with the MC67. When connection is established, the Scan LED turns off and the RS507 emits one string of low/high beeps.
5. On the MC67, touch .

Pairing the RS507 Hands-Free Imager Bluetooth HID



An RS507 Hands-free Imager can be used with the device to capture bar code data.

1. Ensure that Bluetooth is enabled on both devices.
2. Ensure that the Bluetooth device to discover is in discoverable mode.
3. Ensure that the two devices are within 10 meters (32.8 feet) of one another.
4. Place the RS507 in Human Interface Device (HID) mode. If the RS507 is already in HID mode, skip to step 5.
 - a. Remove the battery from the RS507.
 - b. Press and hold the Restore key.
 - c. Install the battery onto the RS507.
 - d. Keep holding the Restore key for about five seconds until a chirp is heard and the Scan LEDs flash green.
 - e. Scan the bar code below to place the RS507 in HID mode.



Figure 5-9 *RS507 Bluetooth HID Bar Code*

5. Remove the battery from the RS507.
6. Re-install the battery into the RS507.

7. On the MC67, touch .
8. Touch .
9. Touch  **Bluetooth**.
10. Touch **SCAN FOR DEVICES**. The device begins searching for discoverable Bluetooth devices in the area and displays them under **AVAILABLE DEVICES**.
11. Scroll through the list and select RS507.

The device connects to the RS507 and **Connected** appears below the device name. The Bluetooth device is added to the **Bluetooth devices** list and a trusted ("paired") connection is established.





DataWedge

DataWedge is a utility that adds advanced bar code scanning capability to any application without writing code. It runs in the background and handles the interface to built-in bar code scanners. The captured bar code data is converted to keystrokes and sent to the target application as if it was typed on the keypad.





DataWedge support Data Capture Plus feature which places a scan button on the display allowing for optional scan method.

To configure DataWedge refer to the *MC67 Integrator Guide*.

Enabling DataWedge

1. Touch  > .
2. Press .
3. Touch **Settings**.
4. Touch the **DataWedge enabled** checkbox. A blue checkmark appears in the checkbox indicating that DataWedge is enabled.
5. Press .

Disabling DataWedge

1. Touch  > .
2. Touch .
3. Touch **Settings**.
4. Touch the **DataWedge enabled** checkbox. The blue checkmark disappears from the checkbox indicating that DataWedge is disabled.
5. Press .

CHAPTER 6 WIRELESS

This section provides information on the wireless features:

- Wireless Wide Area Network (WWAN)
- Wireless Local Area Network (WLAN)
- Bluetooth.

Wireless Wide Area Networks

Use Wireless wide area networks (WWANs) to access data over a cellular network. This section provides information on:

- Sharing a data connection
- Disabling data roaming
- Monitoring data usage
- Limiting connections to 2G networks
- Locking a SIM card
- Verizon Network mode
- Verizon system select
- Editing Access Point Names (APNs).

Sharing the Mobile Data Connection



The **tethering** settings allow you to share your data connection. You can share the MC67's mobile data connection with a single computer via USB tethering or Bluetooth tethering. While the MC67 is sharing its data connection, an icon appears at the top of the screen and a corresponding message appears in the notification list.

USB Tethering

- ✓ **NOTE** USB tethering is not supported on computers running Mac OS. If your computer is running Windows 7 or a recent version of Linux (such as Ubuntu), follow these instructions without any special preparation. If running a version of Windows that precedes Windows 7, or some other operating system, you may need to prepare the computer to establish a network connection via USB.

1. Connect the device to a host computer with the USB cable.

A USB icon appears at the top of the screen, and the notification **Connected as a media device** or **Connected as a camera** appears briefly at the top of the screen.



2. Touch  >  > **More ...** > **Tethering & portable hotspot**.
3. Check **USB tethering**.

The host computer is now sharing the device's data connection.

To stop sharing the data connection, uncheck **USB tethering** or disconnect the USB cable.

Wi-Fi Tethering



Use Wi-Fi Tethering to turn the MC67 into a portable Wi-Fi hotspot for up to 10 other devices, like laptop computers:

1. Touch  >  > **More ...** > **Tethering & portable hotspot**.
2. Touch **Portable Wi-Fi hotspot**.
3. Touch **Set up Wi-Fi hotspot**.
4. In the **Network SSID** field, edit the name for the hotspot, if desired.
5. In the **Password** field, enter a password.
6. Touch **Save**.
7. On the other device to use the Wi-Fi hotspot on, select this network from the list of Wi-Fi options and enter the password to connect to the Internet.
8. To stop sharing the data connection, uncheck **Portable Wi-Fi hotspot**.

Bluetooth Tethering

Use Bluetooth tethering to share the data connection with a host computer.

Configure the host computer to obtain its network connection using Bluetooth. For more information, see the host computer's documentation.



1. Pair the device with the host computer.
2. Touch  >  > **More ...** > **Tethering & portable hotspot**.
3. Check **Bluetooth tethering**.

The host computer is now sharing the device's data connection.

To stop sharing the data connection, uncheck **Bluetooth tethering**.

Disabling Data When Roaming



To prevent the device from transmitting data over other carriers' mobile networks when leaving an area that is covered by the carrier's networks. This is useful for controlling expenses if the service plan does not include data roaming.

1. Touch  >  > **More ...** > **Mobile networks**.
2. Un-check **Data roaming**.
3. Touch .

Limiting Data Connection to 2G Networks

✓ **NOTE** This feature is only available on some networks. Check with service provider.

Extend the battery life by limiting the data connections to 2G networks (GPRS or EDGE). When connected to a 2G network, the user may want to postpone activities that transmit a lot of data, such as sending, uploading, or downloading pictures or video, until they are connected to a faster mobile or other wireless network.

1. Touch  >  > **More ...** > **Mobile networks**.
2. Touch **GSM 2G/3G selection**.
3. Touch **2G only**.
4. Touch .

Locking the SIM Card

Locking the SIM card requires the user to enter a PIN every time the device is turned on. If the correct PIN is not entered, only Emergency calls can be made.

1. Touch  >  >  **Security**.
2. Touch **Set up SIM card lock**.
3. Touch **Lock SIM card**.

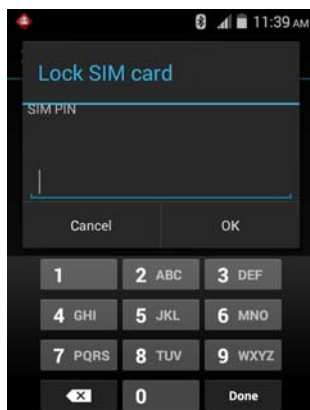







Figure 6-1 Enter PIN to Lock SIM Card

4. Enter the PIN associated with the card. Touch **OK**.
5. Reset the device.

Editing the Access Point Name

✓ **NOTE** Many service provider Access Point Name (APN) data are pre-configured in the device. The APN information for all other service providers must be obtained from the wireless service provider.

To use the data on a network the user must configure the APN information.

1. Touch  >  > **More**
2. Touch **Mobile networks**.
3. Touch **Access Point Names**.
4. Touch .
5. Touch **New APN**.
6. Touch each APN settings and enter the appropriate data obtained from the wireless service provider.
7. When finished, touch .
8. Touch **Save**.
9. Touch the radio button next to the new APN name to start using it.
10. Touch .

Wireless Local Area Networks

Wireless local area networks (WLANs) allow the MC67 to communicate wirelessly inside a building. Before using the MC67 on a WLAN, the facility must be set up with the required hardware to run the WLAN (sometimes known as infrastructure). The infrastructure and the MC67 must both be properly configured to enable this communication.

Refer to the documentation provided with the infrastructure (access points (APs), access ports, switches, Radius servers, etc.) for instructions on how to set up the infrastructure.

Once the infrastructure is set up to enforce the chosen WLAN security scheme, use the **Wireless & networks** settings configure the MC67 to match the security scheme.

The MC67 supports the following WLAN security options:

- Open
- Wireless Equivalent Privacy (WEP).
- Wi-Fi Protected Access (WPA)/WPA2 Personal (PSK).

- Extensible Authentication Protocol (EAP).
 - Lightweight Extensible Authentication Protocol (LEAP).
 - FAST - with Microsoft Challenge-Handshake Authentication Protocol version 2 (MSCHAPv2) and Generic Token Card (GTC) authentication.
 - Protected Extensible Authentication Protocol (PEAP) - with MSCHAPv2 and GTC authentication.
 - Transport Layer Security (TLS)
 - TTLS - with Password Authentication Protocol (PAP), MSCHAP and MSCHAPv2 authentication.

The **Status** bar displays icons that indicate Wi-Fi network availability and Wi-Fi status. See [Status Bar on page 2-2](#) for more information.



NOTE Turn off Wi-Fi when not using it, to extend the life of the battery.

Scan and Connect to a Wi-Fi Network

1. Touch  > .

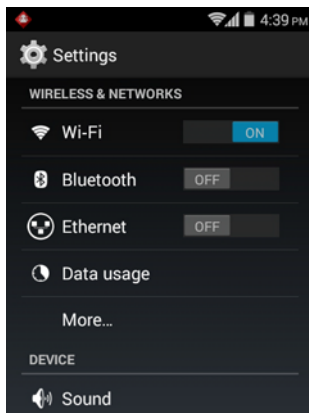

Figure 6-2 Settings Screen

2. Slide the **Wi-Fi** switch to the **ON** position.
3. Touch  **Wi-Fi**. The MC67 searches for WLANs in the area and lists them.



Figure 6-3 Wi-Fi Screen



4. Scroll through the list and select the desired WLAN network.
5. For open networks, touch profile once or press and hold and then select **Connect to network** or for secure networks enter the required password or other credentials then touch **Connect**. See the system administrator for more information.

The MC67 obtains a network address and other required information from the network using the dynamic host configuration protocol (DHCP) protocol. To configure the MC67 with a fixed internet protocol (IP) address, See [Configuring the Device to Use a Static IP Address on page 6-9](#).

6. In the Wi-Fi setting field, **Connected** appears indicating that the MC67 is connected to the WLAN.

Configuring a Wi-Fi Network

To set up a Wi-Fi network:

1. Touch  >  >  **Wi-Fi**.
2. Slide the switch to the **ON** position.
3. The device searches for WLANs in the area and lists them on the screen.
4. Scroll through the list and select the desired WLAN network.
5. Touch the desired network. If the network security is **Open**, the device automatically connects to the network. For all other network security a dialog box appears.

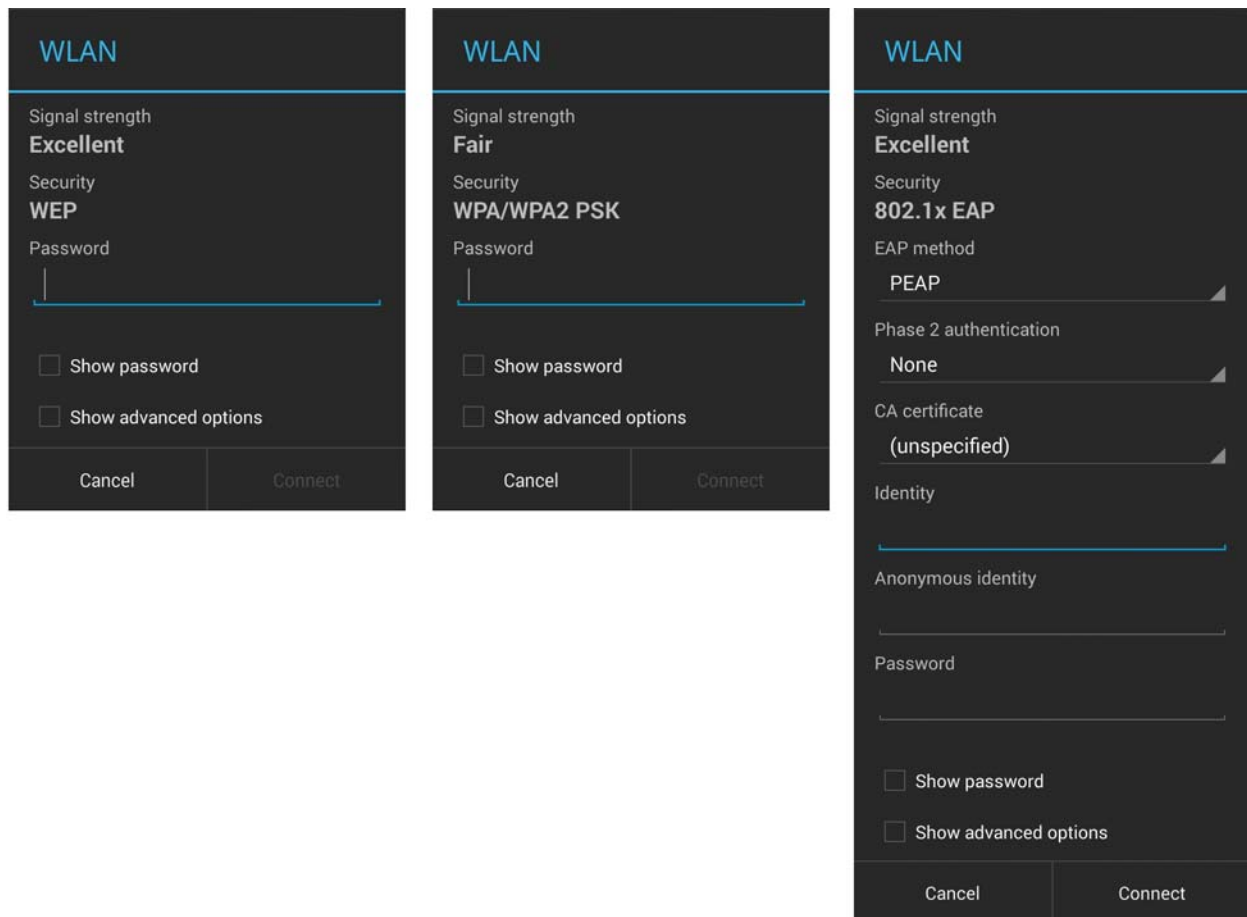





Figure 6-4 WLAN Network Security Dialog Box

6. If the network security is **WEP** or **WPA/WPS2 PSK**, enter the required password and then touch **Connect**.
 7. If the network security is 802.1x EAP:
 - Touch the EAP method drop-down list and select **PEAP, TLS, TTLS** or **PWD**.
 - Touch the **Phase 2 authentication** drop-down list and select an authentication method.
 - If required, touch **CA certificate** and select a Certification Authority (CA) certificate. Note: Certificates are installed using the **Security** settings.
 - If required, touch **User certificate** and select a user certificate. Note: User certificates are installed using the Location & security settings.
 - If required, in the **Identity** text box, enter the username credentials.
 - If desired, in the **Anonymous identity** text box, enter an anonymous identity username.
 - If required, in the **Password** text box, enter the password for then given identity.
- ✓ **NOTE** By default, the network Proxy is set to None and the IP settings is set to DHCP. See [Configuring for a Proxy Server on page 6-8](#) for setting connection to a proxy server and see [Configuring the Device to Use a Static IP Address on page 6-9](#) for setting the device to use a static IP address.
8. Touch **Connect**.
 9. Press .

Manually Adding a Wi-Fi Network

Manually add a Wi-Fi network if the network does not broadcast its name (SSID) or to add a Wi-Fi network when out of range.

1. Touch  >  >  **Wi-Fi**.
2. Slide the Wi-Fi switch to the **On** position.
3. Touch **+** in the bottom left corner of the screen.
4. In the **Network SSID** text box, enter the name of the Wi-Fi network.
5. In the **Security** drop-down list, select the type of security. Options:
 - **None**
 - **WEP**
 - **WPA/WPA2 PSK**
 - **802.1x EAP**.
6. If the network security is **None**, touch **Save**.
7. If the network security is **WEP** or **WPA/WPA2 PSK**, enter the required password and then touch **Save**.
8. If the network security is **802.1x EAP**:
 - Touch the **EAP method** drop-down list and select **PEAP, TLS, PWD** or **TTLS**.
 - Touch the **Phase 2 authentication** drop-down list and select an authentication method.
 - If required, touch **CA certificate** and select a Certification Authority (CA) certificate. Note: Certificates are installed using the **Security** settings.

- If required, touch **User certificate** and select a user certificate. Note: User certificates are installed using the **Security** settings.
- If required, in the **Identity** text box, enter the username credentials.
- If desired, in the **Anonymous** identity text box, enter an anonymous identity username.
- If required, in the **Password** text box, enter the password for then given identity.

✓ **NOTE** By default, the network Proxy is set to None and the IP settings is set to DHCP. See [Configuring for a Proxy Server on page 6-8](#) for setting connection to a proxy server and see [Configuring the Device to Use a Static IP Address on page 6-9](#) for setting the device to use a static IP address.

9. Touch **Connect**.

10. Press .

Configuring for a Proxy Server

A proxy server is a server that acts as an intermediary for requests from clients seeking resources from other servers. A client connects to the proxy server, requesting some service, such as a file, connection, web page, or other resource, available from a different server. The proxy server evaluates the request according to its filtering rules. For example, it may filter traffic by IP address or protocol. If the request is validated by the filter, the proxy provides the resource by connecting to the relevant server and requesting the service on behalf of the client.

It is important for enterprise customers to be able to set up secure computing environments within their companies, and proxy configuration is an essential part of doing that. Proxy configuration acts as a security barrier ensuring that the proxy server monitors all traffic between the Internet and the intranet. This is normally an integral part of security enforcement in corporate firewalls within intranets.

1. In the network dialog box, touch a network.
2. Touch **Show advanced options** checkbox.
3. Touch **Proxy settings** and select **Manual**.

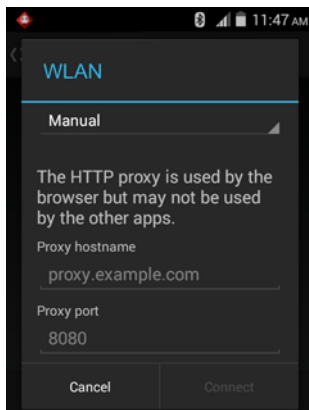



Figure 6-5 Proxy Settings

4. In the **Proxy hostname** text box, enter the address of the proxy server.
5. In the **Proxy port** text box, enter the port number for the proxy server.

✓ **NOTE** When entering proxy addresses the **Bypass proxy for** field, do not use spaces or carriage returns between addresses.

6. In the **Bypass proxy for** text box, enter addresses for web sites that do not require to go through the proxy server. Use the separator “|” between addresses.
7. Touch **Connect**.
8. Press .

Configuring the Device to Use a Static IP Address

By default, the device is configured to use Dynamic Host Configuration Protocol (DHCP) to assign an Internet protocol (IP) address when connecting to a wireless network. To configure the device to connect to a network using a static IP address:

1. In the network dialog box, touch a network.
2. Touch **Show advanced options** checkbox.
3. Touch **IP settings** and select **Static**.

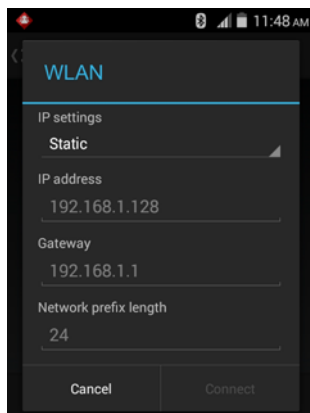





Figure 6-6 *Static IP Settings*

4. In the **IP address** text box, enter an IP address for the device.
5. If required, in the **Gateway** text box, enter a gateway address for the device.
6. If required, in the **Network prefix length** text box, enter a the prefix length.
7. If required, in the **DNS 1** text box, enter a Domain Name System (DNS) address.
8. If required, in the **DNS 2** text box, enter a DNS address.
9. Touch **Connect**.
10. Press .

Advanced Wi-Fi Settings

 **NOTE** Advanced Wi-Fi settings are for the device not for a specific wireless network.

Use the **Advanced** settings to configure additional Wi-Fi settings. From the **Wi-Fi** screen, press  > **Advanced** to view the advanced settings.

- **General**
 - **Network notification** - When enabled, notifies the user when an open network is available.
 - **Keep Wi-Fi on during sleep** - Opens a menu to set whether and when the Wi-Fi radio turns off.
 - **Always On** - The radio stays on when the device enters suspend mode.
 - **Only when plugged in** - The radio stays on while the device is connected to external power.
 - **Never On** - The radio turns off when the device enters suspend mode (default).
 - **Install Certificates** -
 - **MAC address** - Displays the Media Access Control (MAC) address of the device when connecting to Wi-Fi networks.
- **Regulatory**
 - **Country selection** - Displays the acquired country code if 802.11d is enabled else it displays the currently selected country code.
 - **Region code** - Displays the current region code.
- **Band and Channel Selection**
 - **Wi-Fi frequency band** - Use to select the frequency band. Options: **Auto** (default), **5 GHz only** or **2.4 GHz only**.
 - **Available channels (2.4 GHz)** - Use to select specific channels. Touch to display the **Available channels** menu. Select specific channels. Touch **OK**.
 - **Available channels (5 GHz)** - Use to select specific channels. Touch to display the **Available channels** menu. Select specific channels. Touch **OK**.
- **Logging**
 - **Advanced Logging** - Provides support for continuous capture of system logs to a file to help in debugging and resolution of Wi-Fi related issues. Disabled by default. In the **Advanced Logging** dialog box, select **Enable Logging**. If desired, change the log directory location. When enabled, the following log are captured:
 - ✓ **NOTE** The MC67 must have a microSD card installed.
 - Fusion will ask the user whether he wants to clear out previous logs before starting logging.
 - tcpdump capture file and *fusion-sysinfo.log* will only be generated when advanced logging is stopped.
 - Android logcat output with time stamps and the kernel messages in the file: *fusion-wlan.log*.
 - tcpdump intermediate capture of packets between network stack and driver in the file: *fusion-pktcap.pcap*
 - Fusion versions, Wi-Fi state machine logs and other framework information in the file: *fusion-sysinfo.log*.
 - **Wireless logs** - Use to capture Wi-Fi log files.
 - **Fusion Logger** - Touch to open the **Fusion Logger** application. This application maintains a history of high level WLAN events which helps to understand the status of connectivity.

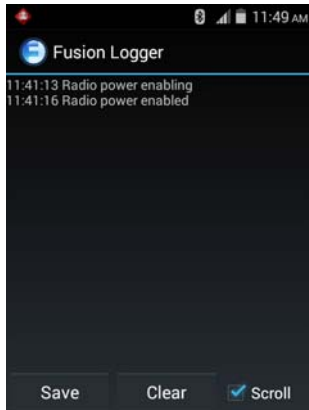

Figure 6-7 Fusion Logger Screen

- **Fusion Status** - Touch to display live status of WLAN state. Also provides information of device and connected profile.







Figure 6-8 Fusion Status Screen

- **About**
 - **Version** - Displays the current Fusion information.

Remove a Wi-Fi Network

To remove a remembered or connected network:

1. Touch  >  >  **Wi-Fi**.
2. In the **Wi-Fi networks** list, touch and hold the name of the network.
3. In the menu, touch **Forget network**.
4. Press .

Bluetooth

Bluetooth-equipped devices can communicate without wires, using frequency-hopping spread spectrum (FHSS) radio frequency (RF) to transmit and receive data in the 2.4 GHz Industry Scientific and Medical (ISM) band

(802.15.1). Bluetooth wireless technology is specifically designed for short-range (10 meters (32.8 feet)) communication and low power consumption.

Devices with Bluetooth capabilities can exchange information (e.g., files, appointments, and tasks) with other Bluetooth enabled devices such as printers, access points, and other mobile devices.

Adaptive Frequency Hopping

Adaptive Frequency Hopping (AFH) is a method of avoiding fixed frequency interferers, and can be used with Bluetooth voice. All devices in the piconet (Bluetooth network) must be AFH-capable in order for AFH to work. There is no AFH when connecting and discovering devices. Avoid making Bluetooth connections and discoveries during critical 802.11b communications. AFH for Bluetooth consists of four main sections:

- Channel Classification - A method of detecting an interference on a channel-by-channel basis, or pre-defined channel mask.
- Link Management - Coordinates and distributes the AFH information to the rest of the Bluetooth network.
- Hop Sequence Modification - Avoids interference by selectively reducing the number of hopping channels.
- Channel Maintenance - A method for periodically re-evaluating the channels.

When AFH is enabled, the Bluetooth radio “hops around” (instead of through) the 802.11b high-rate channels. AFH coexistence allows Enterprise devices to operate in any infrastructure.

The Bluetooth radio in this device operates as a Class 2 device power class. The maximum output power is 2.5 mW and the expected range is 10 meters (32.8 ft.). A definition of ranges based on power class is difficult to obtain due to power and device differences, and whether one measures open space or closed office space.



NOTE It is not recommended to perform Bluetooth wireless technology inquiry when high rate 802.11b operation is required.

Security

The current Bluetooth specification defines security at the link level. Application-level security is not specified. This allows application developers to define security mechanisms tailored to their specific need. Link-level security occurs between devices, not users, while application-level security can be implemented on a per-user basis. The Bluetooth specification defines security algorithms and procedures required to authenticate devices, and if needed, encrypt the data flowing on the link between the devices. Device authentication is a mandatory feature of Bluetooth while link encryption is optional.

Pairing of Bluetooth devices is accomplished by creating an initialization key used to authenticate the devices and create a link key for them. Entering a common personal identification number (PIN) in the devices being paired generates the initialization key. The PIN is never sent over the air. By default, the Bluetooth stack responds with no key when a key is requested (it is up to user to respond to the key request event). Authentication of Bluetooth devices is based-upon a challenge-response transaction. Bluetooth allows for a PIN or passkey used to create other 128-bit keys used for security and encryption. The encryption key is derived from the link key used to authenticate the pairing devices. Also worthy of note is the limited range and fast frequency hopping of the Bluetooth radios that makes long-distance eavesdropping difficult.

Recommendations are:

- Perform pairing in a secure environment
- Keep PIN codes private and do not store the PIN codes in the device
- Implement application-level security.

Bluetooth Profiles

The MC67 supports the following Bluetooth services:

- **Generic Access Profile (GAP)** - Use for device discovery and authentication.
- **Service Discovery Protocol (SDP)** - Handles the search for known and specific services as well as general services.
- **Serial Port Profile (SPP)** - Sets up a virtual serial port and connects two Bluetooth enabled devices. For example, connecting the MC67 to a printer.
- **Headset Profile (HSP)** - Allows a hands-free device, such as a Bluetooth headset, to place and receive calls on the MC67.
- **Hands-Free Profile (HFP)** - Allow car hands-free kits to communicate with mobile phones in the car.
- **Dial-up Networking (DUN)** - Allows the MC67 to access the Internet and other dial-up services using a Bluetooth enabled mobile phone.
- **General Object Exchange Profile (GOEP)** - Provides a basis for other data profiles. Based on OBEX and sometimes referred to as such.
- **Object Push Profile (OPP)** - Allows the MC67 to push and pull objects to and from a push server.
- **Advanced Audio Distribution Profile (A2DP)** - Allows the MC67 to stream stereo-quality audio to a wireless headset or wireless stereo speakers.
- **Audio/Video Remote Control Profile (AVRCP)** - Allows the MC67 to control A/V equipment to which a user has access. It may be used in concert with A2DP.
- **Personal Area Network (PAN)** - Allow the use of Bluetooth Network Encapsulation Protocol on Layer 3 protocols for transport over a Bluetooth link.
- **PhoneBook Access Profile (PBAP)** - Allows exchange of Phone Book Objects between a car kit and a mobile phone to allow the car kit to display the name of the incoming caller; allow the car kit to download the phone book so the user can initiate a call from the car display.
- **Human Interface Device Profile (HID)** - Allows Bluetooth keyboards, pointing devices, gaming devices and remote monitoring devices to connect to the MC67.

Bluetooth Power States

The Bluetooth radio is off by default.

- **Suspend** - When the MC67 goes into suspend mode, the Bluetooth radio stays on.
- **Airplane Mode** - When the MC67 is placed in Airplane Mode, the Bluetooth radio turns off. When Airplane mode is disabled, the Bluetooth radio returns to the prior state. When in Airplane Mode, the Bluetooth radio can be turned back on if desired.

Bluetooth Radio Power

Turn off the Bluetooth radio to save power or if entering an area with radio restrictions (e.g., an airplane). When the radio is off, other Bluetooth devices cannot see or connect to the device. Turn on the Bluetooth radio to exchange information with other Bluetooth devices (within range). Communicate only with Bluetooth radios in close proximity.





NOTE To achieve the best battery life turn off radios when not in use.

Enabling Bluetooth



1. Touch  > .
2. Slide the Bluetooth switch to the **ON** position.  also appears in the Status bar.
3. Press .

Disabling Bluetooth

1. Touch  > .
2. Slide the Bluetooth switch to the **OFF** position.
3. Press .

Discovering Bluetooth Device(s)

The MC67 can receive information from discovered devices without pairing. However, once paired, the MC67 and a paired device exchange information automatically when the Bluetooth radio is on. To find Bluetooth devices in the area:

1. Ensure that Bluetooth is enabled on both devices.
2. Ensure that the Bluetooth device to discover is in discoverable mode.
3. Ensure that the two devices are within 10 meters (32.8 feet) of one another.
4. Touch  >  >  **Bluetooth**.
5. Touch **SCAN FOR DEVICES**. The MC67 begins searching for discoverable Bluetooth devices in the area and displays them under **AVAILABLE DEVICES**.
6. Scroll through the list and select a device. The **Bluetooth pairing request** dialog box appears.

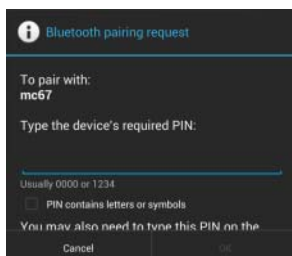

Figure 6-9 Bluetooth Pairing - Enter PIN

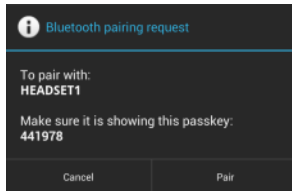

Figure 6-10 *Bluetooth Pairing - Smart Pairing*

7. Enter a PIN in the text box and touch **OK**. Enter the same PIN on the other device.
8. For Simple Pairing, touch **Pair** on both devices.
9. The Bluetooth device is added to the **Bluetooth devices** list and a trusted (“paired”) connection is established.

Changing the Bluetooth Name

By default, the MC67 has a generic Bluetooth name that is visible to other devices when connected.

1. Touch > > **Bluetooth**.
2. If Bluetooth is not on, slide the switch to the **ON** position.
3. Touch .
4. Touch **Rename device**.
5. Enter a name and touch **Done**.
6. Touch .

Connecting to a Bluetooth Device

Once paired, connect to a Bluetooth device.

1. Touch > > **Bluetooth**.
2. If Bluetooth is not on, slide the switch to the **ON** position.
3. In the **PAIRED DEVICES** list, touch an unconnected Bluetooth device to initiate connection. When connected, the device is displayed as connected in the list.

Selecting Profiles on the Bluetooth Device

Some Bluetooth devices have multiple profiles. To select a profile:



1. Touch > **Bluetooth**.
2. In the **PAIRED DEVICES** list, touch next to the device name.
3. Under **PROFILES**, check or uncheck a profile to allow the device to use that profile.
4. Press .

Unpairing a Bluetooth Device

To unpair a Bluetooth device and erase all pairing information:

1. Touch  >  >  **Bluetooth**.
2. In the **PAIRED DEVICES** list, touch  next to the device name.
3. Touch **Unpair**.
4. Press .

Data Usage

Data usage refers to the amount of data uploaded or downloaded by the device during a given period. To monitor data usage, go to  >  >  **Data usage**.

Data usage settings allow you to:

- Set the mobile data usage level at which you'll receive a warning.
- Set a mobile data usage limit.
- View or restrict data usage by application.
- Identify mobile hotspots and restrict background downloads that may result in extra charges.
- View data usage for Wi-Fi and Ethernet networks.

By default, when you open the data usage settings screen **MOBILE**, **WI-FI** and **ETHERNET** tabs display.

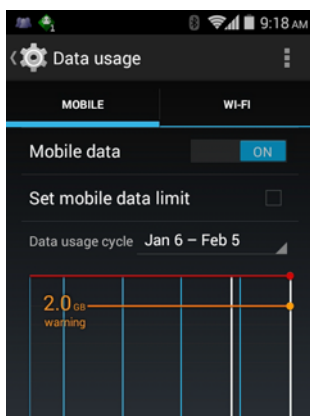



Figure 6-11 Data Usage Screen

To hide **WI-FI** or **ETHERNET** tabs, touch  > **Show Wi-Fi usage** or **Show Ethernet usage**.

Mobile Data Usage

The usage displayed on the data usage settings screen is measured by your device. Your carrier's data usage accounting may differ. Usage in excess of your carrier plan's data limits can result in steep overage charges. The feature described here can help you track your usage, but is not guaranteed to prevent additional charges.

Just below the on-off switch is the data usage cycle. Touch it to choose a different cycle. This date range is the period of time for which the graph displays data usage.

The vertical white lines on the graph show a period of time within the data usage cycle. This range determines the usage amount displayed just below the graph. Drag lines to change the period.

Drag the red line by its right side to the level where you want to set the data limit. When your data usage reaches this level, mobile data is disabled.

Drag the orange line by its right side to the level where you want to receive a warning. When your data usage reaches this level, you'll receive a notification.

Below the graph is a list of applications that used data.

Wi-Fi Data Usage

The **WI-FI** tab displays the data usage when connected to a Wi-Fi network.

Touch the data usage cycle to choose a different cycle. This date range is the period of time for which the graph displays data usage.

The vertical white lines on the graph show a period of time within the data usage cycle. This range determines the usage amount displayed just below the graph. Drag lines to change the period.

Below the graph is a list of applications that used data.

Ethernet Data Usage

The **ETHERNET** tab displays the data usage when connected to an Ethernet network.

Touch the data usage cycle to choose a different cycle. This date range is the period of time for which the graph displays data usage.

The vertical white lines on the graph show a period of time within the data usage cycle. This range determines the usage amount displayed just below the graph. Drag lines to change the period.

Set Auto-Sync

You can also conserve data usage by syncing your applications manually, only when you need the data, rather than relying on auto-sync. To turn auto-sync off or on, touch  > **Auto-sync data**.

CHAPTER 7 ACCESSORIES

This chapter provides information for using the accessories for the device.

Accessories

This table lists the accessories available for the MC67.

Table 7-1 *MC67 Accessories*

Accessory	Part Number	Description
Cradles		
Single Slot USB Cradle	CRD-MC5X-RCHG1-01	Charges the MC67 main battery and a spare battery. Synchronizes the MC67 with a host computer through a USB connection.
Four Slot Charge Only Cradle	CRD5501-4000CR	Charges up to four MC67 devices.
Four Slot Ethernet Cradle	CRD5501-4000ER	Charges up to four MC67 devices and connects the MC67 with an Ethernet network. CRD5501-4000ER provides up to a maximum of 1 Gbps.
Single Slot Ethernet/Modem/USB Cradle	CRD5501-1000XR	Charges the MC67 main battery and a spare battery. Synchronizes the MC67 with a host computer through an Ethernet or USB connection.
Vehicle Cradle	VCD5500-1001R	Installs in a vehicle and charges the MC67 main battery.
Vehicle Holder	VCH5500-1000R	Provides an alternative mounting solution for the MC67 in a vehicle. Requires the Auto Charge cable for charging the MC67 battery.

Table 7-1 MC67 Accessories (Continued)

Accessory	Part Number	Description
Chargers		
Four Slot Spare Battery Charger	SAC5500-4000CR	Charges up to four MC67 battery packs.
Power Supply	PWRS-14000-249R	Provides power to the MC67 using the USB Charging Cable or Charge Only Cable.
Power Supply	PWRS-14000-148R	Provides power to the Single Slot USB cradle and Four Slot Spare Battery Charger.
Power Supply	PWRS-14000-241R	Provides power to the Four Slot Charge Only cradle or Four Slot Ethernet cradles.
USB Charging Cable	25-108022-04R	Provides power to the MC67 and USB communication with a host computer.
Charge Only Cable	25-112560-01R	Connects to a power supply to provide power to the MC67.
Auto Charge Cable	VCA5500-01R	Charges the MC67 using a vehicle's cigarette lighter.
DC Cable	50-16002-029R	Provides power from the power supply to the Four Slot cradles.
Miscellaneous		
Spare 3600 mAh lithium-ion battery	BTRY-MC55EAB02 BTRY-MC55EAB02-10 BTRY-MC55EAB02-50	Replacement 3600 mAh battery. (10-pack) (50-pack)
Trigger Handle	TRG5500-101R	Adds a gun-style handle with a scanning trigger for comfortable and productive data capture.
DEX Cable	25-127558-02R	For use with electronic data exchange For example, vending machines.
USB Client Communication Cable	25-68596-01R	Provides USB communication between the Single Slot USB Cradle and a host computer.
Printer Cable	25-136283-01R	Provides connection to a Monarch/Paxar Serial printer.
Magnetic Stripe Reader	MSR5500-100R	Captures data from magnetic stripe cards.
PD40 Payment Device	PD40-100	Adds payment processing capabilities to the MC67 using Bluetooth for credit, debit, loyalty and gift magnetic stripe cards and Chip and PIN-based cards.
Belt Mounted Rigid Holster	SG-MC5511110-01R	Clips onto belt to hold the MC67 when not in use.
Fabric Holster	SG-MC5521110-01R	Soft holder for added protection.

Table 7-1 MC67 Accessories (Continued)

Accessory	Part Number	Description
Stylus	KT-119150-03R KT-119150-50R	Replacement stylus (3-pack). Replacement stylus (50-pack).
Spring Loaded Stylus	STYLUS-00001-10R	Optional spring loaded stylus (10-pack).
Stylus with Tether	Stylus-00003-03R Stylus-00003-50R	Spare stylus with tether (3-pack). Spare stylus with tether (50-pack).
Spare Tether	KT-122621-03R KT-122621-50R	Replacement tether (3-pack). (50-pack).
Handstrap	SG-MC5523341-03R	Replacement handstrap with pin.
Wall Mounting Kit	KT-136648-01R	Use for wall mounting the four slot cradles.
Screen Protector	KT-137521-03R	Package of 3 screen protectors.

Single Slot USB Cradle

This section describes how to use a Single Slot USB cradle with the MC67. For USB communication setup procedures refer to the *MC67 Integrator Guide*.

The Single Slot USB Cradle:

- Provides 5.4 VDC power for operating the MC67.
- Synchronizes information between the MC67 and a host computer. Refer to the MC67 Integrator Guide for information on setting up a partnership between the MC67 and a host computer.
- Charges the MC67's battery.
- Charges a spare battery.

Charging the MC67 Battery

1. Ensure that the cradle is connected to power.
2. Insert the MC67 into the slot to begin charging.

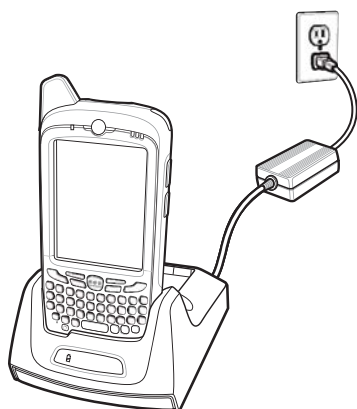

Figure 7-1 MC67 Battery Charging

Charging a Spare Battery

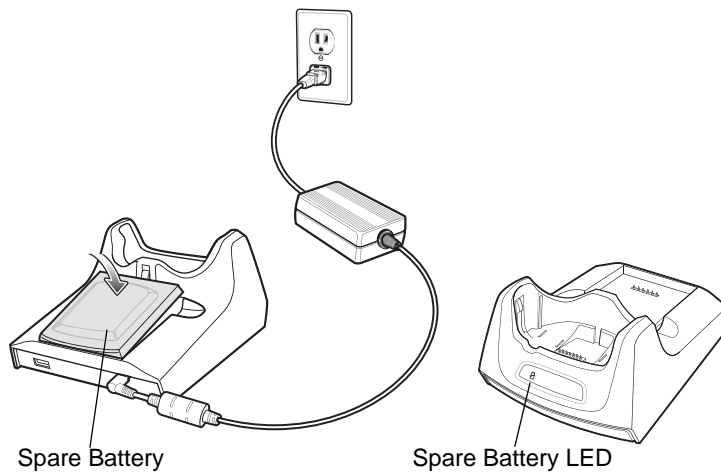

Figure 7-2 Spare Battery Charging

Battery Charging

The Single Slot USB Cradle charges the MC67's main battery and a spare battery simultaneously.

The MC67's charge LED indicates the status of the battery charging in the MC67.

The spare battery charging LED on the cradle indicates the status of the spare battery charging in the cradle.

The 3600 mAh battery fully charges in less than six hours.

Charging Temperature

Charge batteries in temperatures from 0°C to 40°C (32°F to 104°F). Charging is intelligently controlled by the MC67.

To accomplish this, for small periods of time, the MC67 or cradle alternately enables and disables battery charging to keep the battery at acceptable temperatures. The MC67 or cradle indicates when charging is disabled due to abnormal temperatures via its LED.

Four Slot Charge Only Cradle

This section describes how to set up and use a Four Slot Charge Only cradle with the MC67.

The Four Slot Charge Only cradle:

- Provides 5.4 VDC power for operating the MC67.
- Simultaneously charges up to four MC67 devices.

Charging the MC67

1. Insert the MC67 into a slot to begin charging.

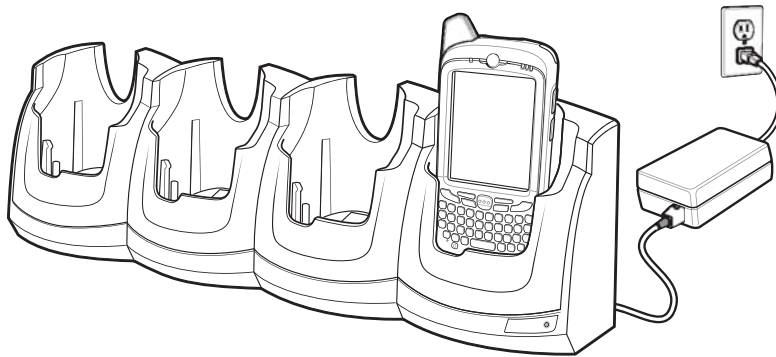

Figure 7-3 MC67 Battery Charging

2. Ensure the MC67 is seated properly.

Battery Charging

Main Battery Charging

The MC67's Charging/Battery Status LED indicates the status of the battery charging in the MC67.

The 3600 mAh battery fully charges in less than six hours.

Charging Temperature

Charge batteries in temperatures from 0°C to 40°C (32°F to 104°F). Charging is intelligently controlled by the MC67.

To accomplish this, for small periods of time, the MC67 alternately enables and disables battery charging to keep the battery at acceptable temperatures. The MC67 indicates when charging is disabled due to abnormal temperatures via its LED.

Four Slot Ethernet Cradle

This section describes how to use a Four Slot Ethernet cradle with the MC67. For cradle communication setup procedures refer to the *MC67 Integrator Guide*.

The Four Slot Ethernet cradle:

- Provides 5.4 VDC power for operating the MC67
- Connects the MC67 (up to four) to an Ethernet network
- Simultaneously charges up to four MC67 devices.

Charging the MC67

1. Insert the MC67 into a slot to begin charging.

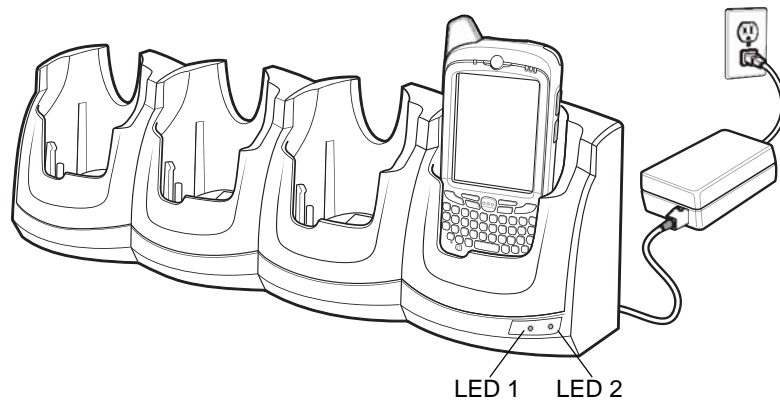

Figure 7-4 MC67 Battery Charging

2. Press down on the MC67 to ensure that it is seated properly.

Battery Charging

Main Battery Charging

The MC67's Charging/Battery Status LED indicates the status of the battery charging in the MC67.

The 3600 mAh battery fully charges in less than six hours.

Charging Temperature



Charge batteries in temperatures from 0 °C to 40 °C (32 °F to 104 °F). Charging is intelligently controlled by the MC67.

To accomplish this, for small periods of time, the MC67 alternately enables and disables battery charging to keep the battery at acceptable temperatures. The MC67 indicates when charging is disabled due to abnormal temperatures via its LED.

Establishing Ethernet Connection



NOTE Refer to the MC67 Integrator Guide for information on configuring the Ethernet settings.

Ethernet is enabled by default. If Ethernet is disabled, turn Ethernet on prior to inserting the MC67 into the cradle. Touch  >  > **Ethernet**. Slide the Ethernet switch to the ON position.

1. Insert the MC67 into a slot.

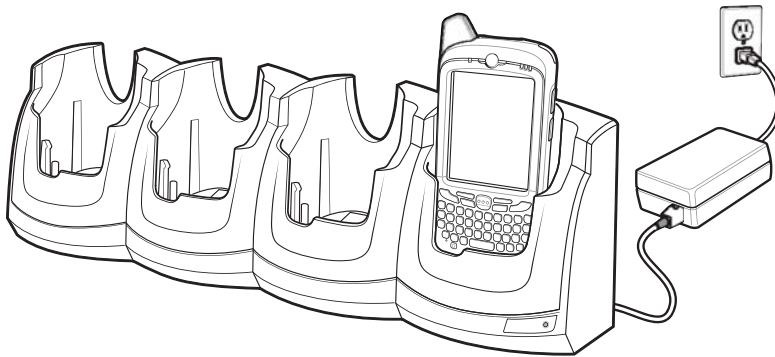



Figure 7-5 MC67 Battery Charging

The  icon appears in the Status bar.

2. Touch **Eth0** to view Ethernet connection details.

LED Indicators (CRD5501-4000ER)

There are two green LEDs on the front of the cradle. These green LEDs light and blink to indicate the data transfer rate. When the LEDs are not lit the transfer rate is 10 Mbps.

Table 7-2 CRD5501-4000ER LED Data Rate Indicators

Data Rate	Left LED (Green)	Right LED (Green)
1 Gbps	On/Blink	Off
100 Mbps	Off	On/Blink
10 Mbps	Off	Off

Single-slot Ethernet/Modem/USB Cradle

✓ **NOTE** The MC67 with Android OS does not support modem connectivity.

The CRD5500-1000XR cradle provides connection to a host computer using USB or an Ethernet network.

Refer to the *MC67 Integrator Guide* for information on setting up the cradle.

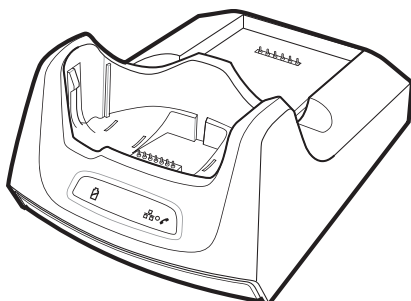

Figure 7-6 Single-slot Ethernet/Modem/USB Cradle

Indicators

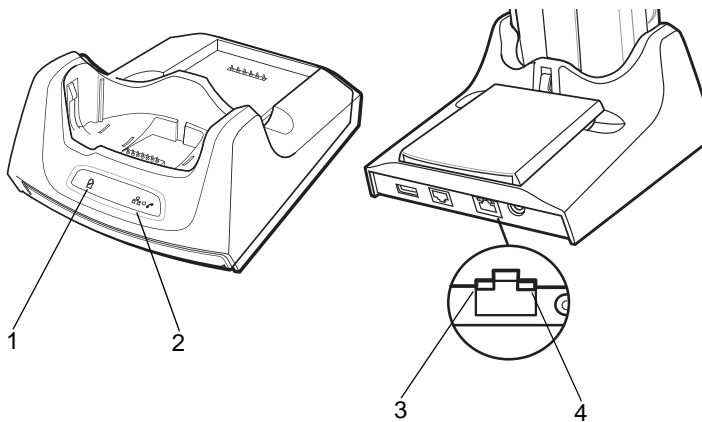

Figure 7-7 Cradle Indicators

- **(1) Spare Battery Charging LED** - Indicates the charging status of the spare battery.
- **(2) Ethernet/Modem LED** - Lights green when there is an active Ethernet connection. Lights yellow when there is an active modem connection.
- **(3) Speed LED**- Lights to indicate that the transfer rate is 100 Mbps. When not lit, indicates that the transfer rate is 10Mbps.
- **(4) Link LED** - Blinks to indicate activity. Stays lit to indicate that a link is established. When not lit, indicates there is no link.

Ethernet Operation

✓ **NOTE** The CRD5501-1000XR does not support hot swapping between operational modes. After moving the switch into a different position, remove the MC67 from the cradle and then re-insert into the cradle.

1. Place the Connection switch on the bottom of the cradle to the Ethernet position.
2. Place the MC67 into the cradle.
3. To test the connection, launch the Browser application and enter a web site address.

USB Operation

✓ **NOTE** The CRD5501-1000XR does not support hot swapping between operational modes. After moving the switch into a different position, remove the MC67 from the cradle and then re-insert into the cradle.

1. Place the Connection switch on the bottom of the cradle to the USB position.
2. Place the MC67 into the cradle.
3. To test the connection, on the host computer open a file explorer and check for MC67 device storage.

Four Slot Battery Charger

This section describes how to use the Four Slot Battery Charger to charge up to four MC67 batteries.

Charging Spare Batteries

1. Connect the charger to a power source.
2. Insert the battery into a battery charging well and gently press down on the battery to ensure proper contact.

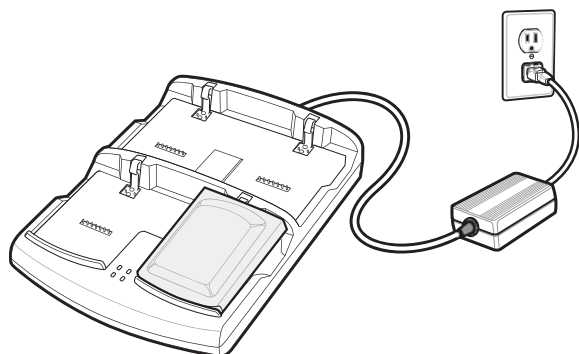

Figure 7-8 Four Slot Battery Charger

Battery Charging

Spare Battery Charging

Each Battery Charging LED indicates the status of the battery charging in each slot. The table below describes the Battery Charging LED status.

The 3600 mAh battery fully charges in less than six hours.

Table 7-3 Battery LED Charging Indicators

LED	Indication
Off	No battery in slot. Battery is not charging. Battery is not inserted correctly in the slot. Charger is not powered.
Slow blinking amber	Battery is charging.
Solid amber	Charging complete.
Fast blinking amber	Charging error.

Charging Temperature

Charge batteries in temperatures from 0 °C to 40 °C (32 °F to 104 °F). Charging is intelligently controlled by the MC67.

To accomplish this, for small periods of time, the changer alternately enables and disables battery charging to keep the battery at acceptable temperatures. The charger indicates when charging is disabled due to abnormal temperatures via its LED.

Magnetic Stripe Reader

The MSR snaps on to the bottom of the MC67 and removes easily when not in use. When attached to the MC67, the MSR allows the MC67 to capture data from magnetic stripe cards. With the MSR attach, the MC67 can still be charged by placing the MC67 with MSR into a cradle or connecting to a charging cable.

Attaching the MSR

1. To attach, slide the MSR onto the bottom of the MC67. Secure by snapping the arms into the MC67 housing.

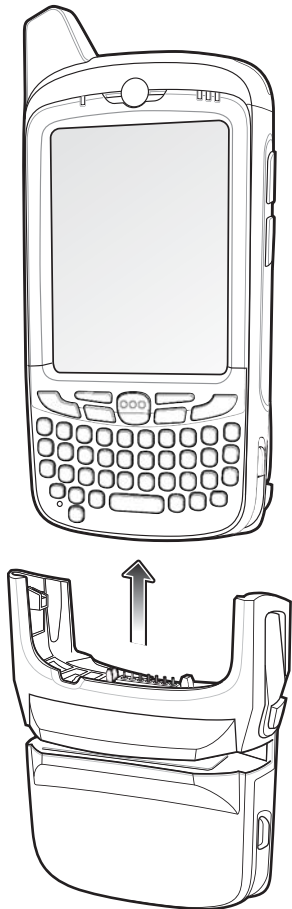

Figure 7-9 MSR Installation

2. Secure by snapping the arms into the MC67 housing.

Removing the MSR

1. To remove the MSR open the arms. Pull the MSR from the MC67.
When attaching a cable with a cup connector through the MSR to charge the device, you cannot swipe cards.
2. Pull the MSR from the MC67.

Using the MSR

Install an MSR enabled application onto the MC67.

1. To use the MSR, attach the MSR to the MC67.
2. Power on the MC67.
3. Launch the MSR application.
4. Swipe the magnetic stripe card through the MSR, with the magnetic stripe on the card facing down. Swipe the card in either direction, from left to right or from right to left. For best results, gently press down on the card while swiping to ensure contact with the bottom of the reader.
5. The application indicates if the data has been read correctly.

VCD5000-1001R Vehicle Cradle

This section describes how to use a VCD5000–1001R vehicle cradle with the MC67. For cradle installation and communication setup procedures refer to the *MC67 Integrator Guide*.

Once installed in a vehicle, the cradle:

- holds the MC67 securely in place
- provides power for operating the MC67
- re-charges the battery in the MC67.

Charging the MC67 Battery

1. Insert the MC67 into the vehicle cradle to begin charging.

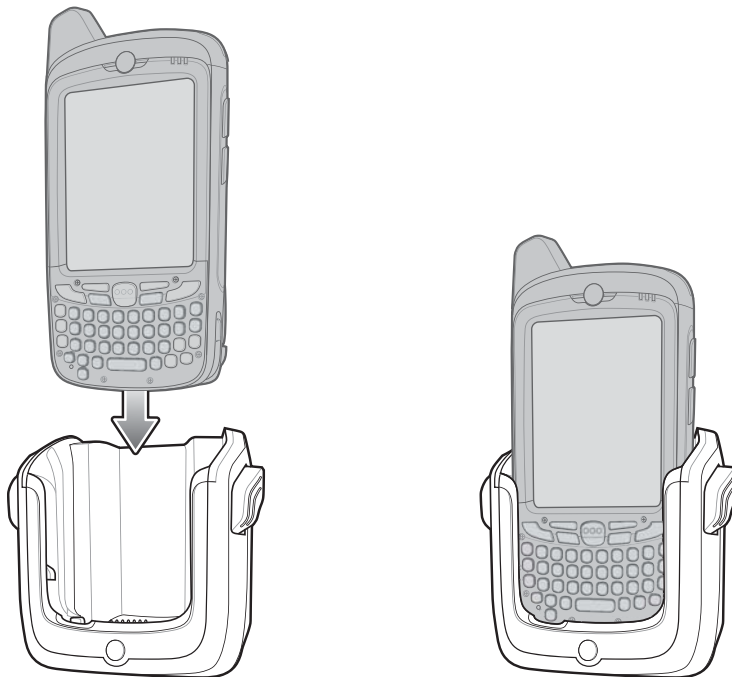

Figure 7-10 MC67 Battery Charging

2. Press the MC67 down to ensure it is seated properly.

A click indicates that the MC67 button release locking mechanism is enabled and the MC67 is locked in place.



CAUTION Ensure the MC67 is fully inserted in the cradle. Lack of proper insertion may result in property damage or personal injury. We are not responsible for any loss resulting from the use of the products while driving.

Removing the MC67

1. Press the release levers on the cradle.
2. Pull the MC67 up and out of the cradle.

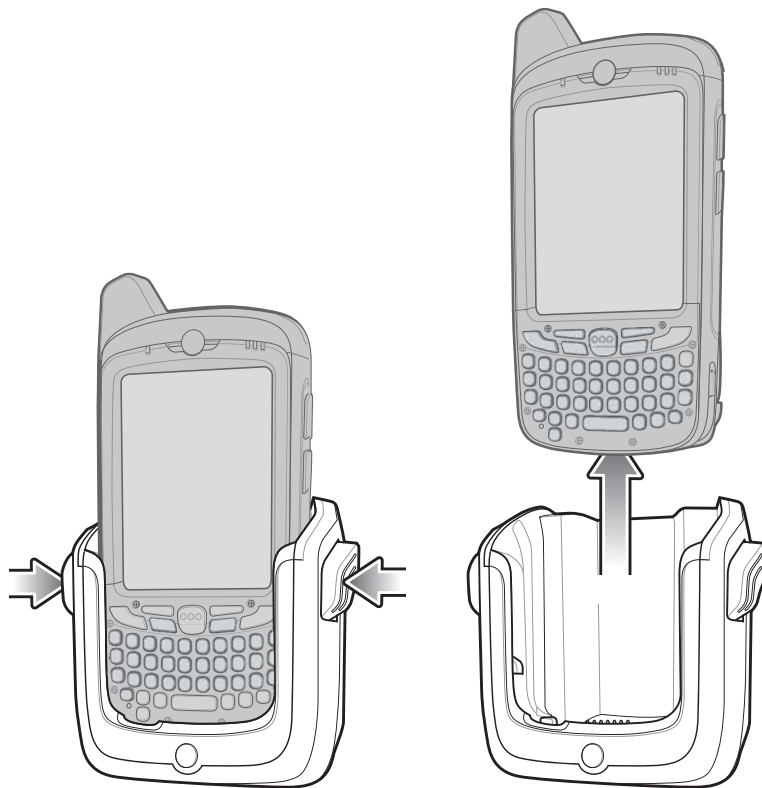

Figure 7-11 Removing the MC67

Battery Charging Indicators

The MC67's Charging/Battery Status LED indicates the status of the battery charging in the MC67.

The 3600 mAh battery fully charges in less than six hours.

Charging Temperature

Charge batteries in temperatures from 0°C to 40°C (32°F to 104°F). Charging is intelligently controlled by the MC67.

To accomplish this, for small periods of time, the MC67 alternately enables and disables battery charging to keep the battery at acceptable temperatures. The MC67 indicates when charging is disabled due to abnormal temperatures via its LED.

Cables

This section describes how to set up and use the cables. The cables are available with a variety of connection capabilities.

The following communication/charge cables are available:

- USB Charging cable
 - Provide the MC67 with operating and charging power when used with the approved power supply.
 - Synchronize information between the MC67 and a host computer. With customized or third party software, it can also synchronize the MC67 with corporate databases.

- Charge Only cable
 - Provide the MC67 with operating and charging power when used with the approved power supply.
- Auto Charge cable
 - Provide the MC67 with operating and charging power when used with the approved power supply.
- DEX cable
 - Provides communication with electronic data exchange devices, such as vending machines.

Battery Charging and Operating Power

The communication/charge cables can charge the MC67 battery and supply operating power.

1. To charge the MC67 battery, connect the communication/charge cable power input connector to the approved power source.
2. Slide the bottom of the MC67 into the connector cup end of the communication/charge cable and gently press in until it latches into the MC67.
3. Slide the two locking tabs up until they both lock into position.

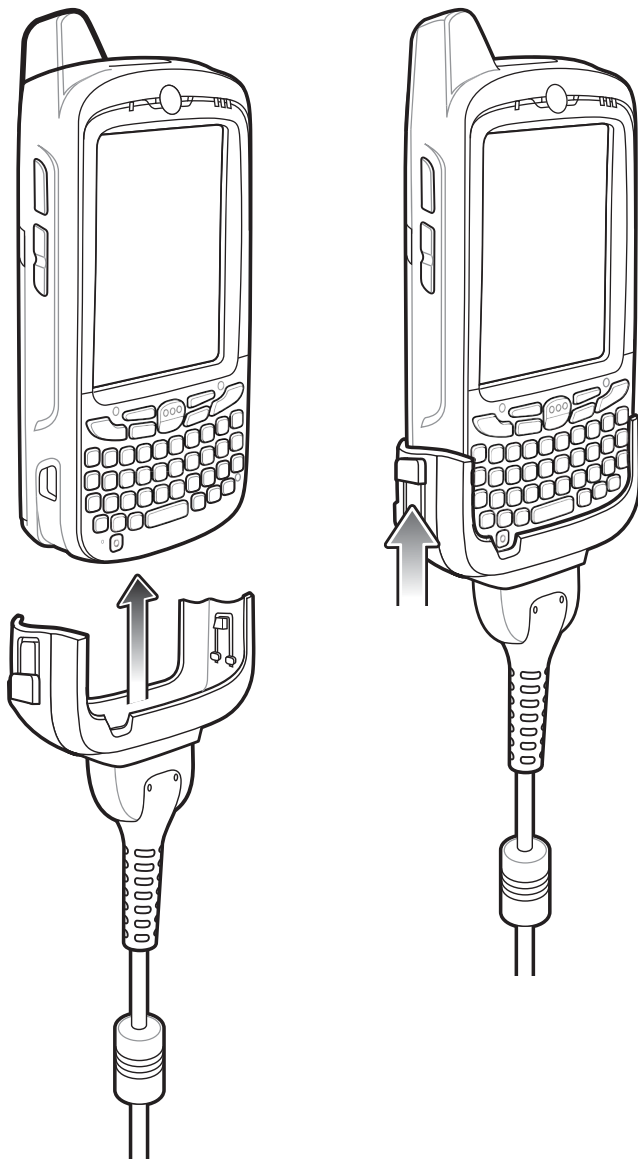

Figure 7-12 *Cable Cup Locking Tabs*

The MC67 amber Charge LED indicates the MC67 battery charging status.

4. When charging is complete, push the two locking tab down and remove the cable from the MC67.

LED Charge Indications

The amber Charge LED on the MC67 indicates battery charging status. See LED Charging Indicators for charging status indications.

Charging Temperature

Charge batteries in temperatures from 0 °C to 40 °C (32 °F to 104 °F). Charging is intelligently controlled by the MC67.

To accomplish this, for small periods of time, the MC67 or accessory alternately enables and disables battery charging to keep the battery at acceptable temperatures. The MC67 or accessory indicates when charging is disabled due to abnormal temperatures via its LED.

Vehicle Holder



WARNING! Some countries prohibit the mounting of any electronic device in any location on the vehicle dashboard and windshield. Be sure to check your local laws acceptable mounting areas before installing the auto mounting kit.

Assembly

1. Insert the vehicle holder's cradle plate to the holes on the back of the cradle.
2. Push the cradle down until both parts are engaged.

Windshield Installation

1. Fix the suction cup mount to the selected area with the suction lever facing up.

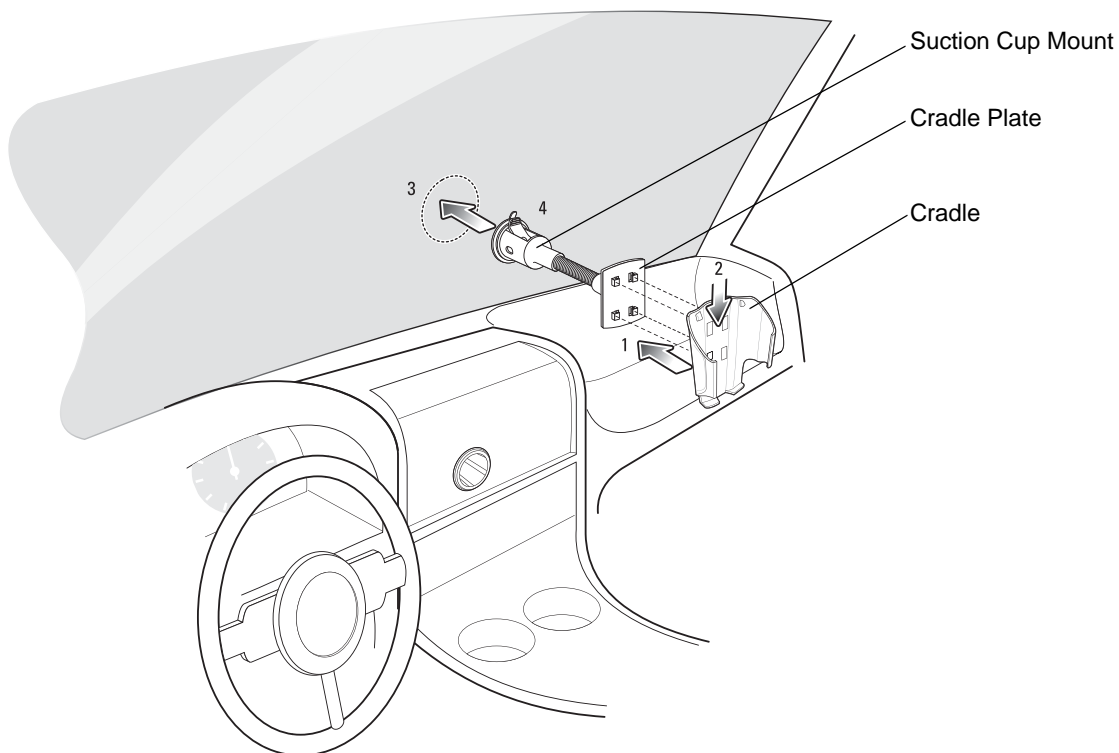

Figure 7-13 Windshield Installation

2. Flip the lever down to create a vacuum between the suction cup and the mounting surface.
3. Make sure that the suction bond is strong enough before proceeding to the next step.
4. Slide the MC67 into the cradle.

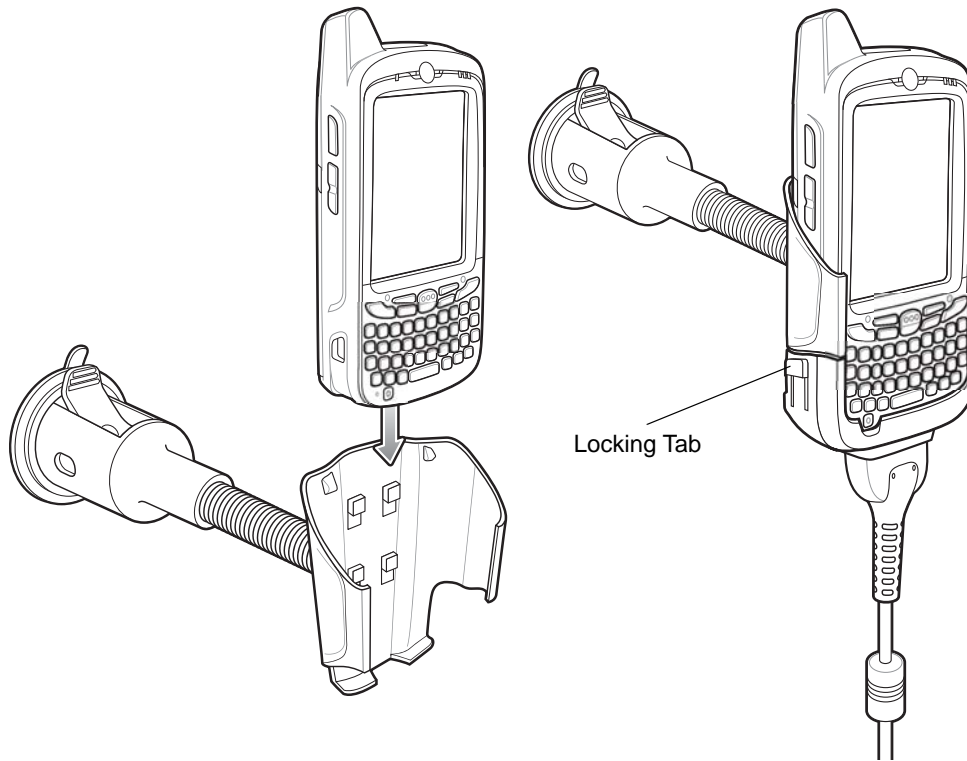

Figure 7-14 *Insert MC67 into Vehicle Holder*

5. Connect the auto charger cable to the MC67 and slide the two locking tabs up to secure the cable cup to the MC67.
6. Connect the other end to the cigarette lighter socket.

Prior to removing the MC67 from the vehicle holder, disconnect the auto-charge cable from the MC67.

The LED indicator on the right side of the touch screen lights up orange during charging.

Flat Surface Installation

1. Remove the plastic sheet on the bottom of the mounting disc.
2. Place the disc, sticky side down, on a clean flat surface.

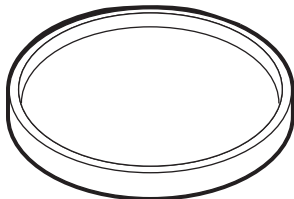

Figure 7-15 *Mounting Disk*

3. Fix the suction cup mount to the disc with the suction lever facing up.
4. Flip the lever down to create a vacuum between the suction cup and the disc.
5. Make sure that the suction bond is strong enough before proceeding to the next step.
6. Slide the MC67 into the cradle.

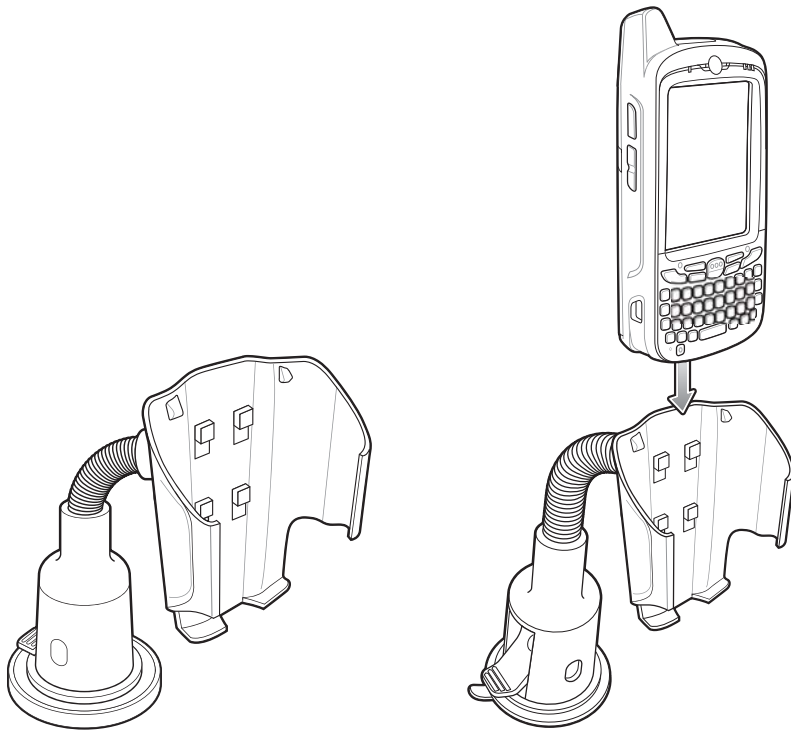

Figure 7-16 *Vehicle Holder Mounted on Flat Surface*

7. Connect the auto charger cable to the MC67 and slide the two locking tabs up to secure the cable cup to the MC67.
8. Connect the other end to the cigarette lighter socket.

The LED indicator on the right side of the touch screen lights up orange during charging.

Trigger Handle

The TRG5500 Trigger Handle adds a gun-style handle with a scanning trigger to the MC67. It increases comfort when using the MC67 in scan-intensive applications for extended periods of time.

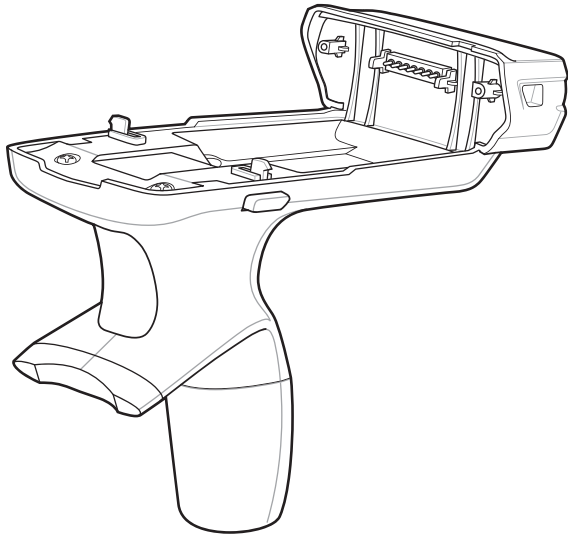

Figure 7-17 *Trigger Handle Features*

Inserting the MC67 into the Trigger Handle

1. Slide the bottom of the MC67 into the Trigger Handle.

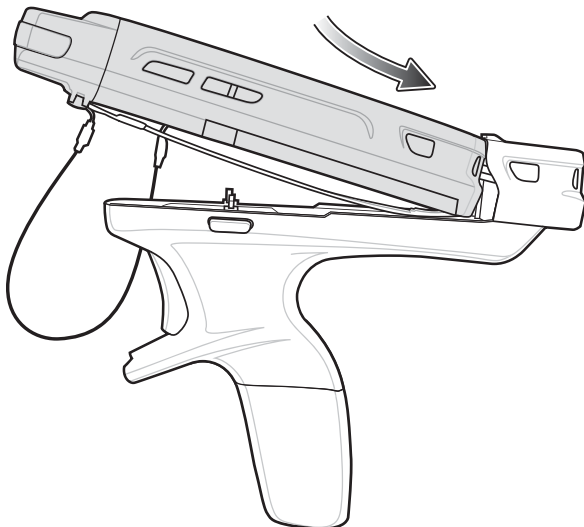

Figure 7-18 *Insert MC67 Into Trigger Handle*

2. Rotate the MC67 down and press down to lock into the Trigger Handle.

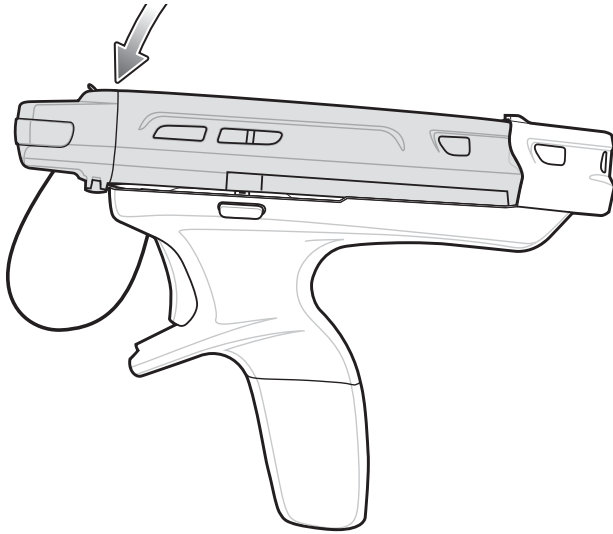

Figure 7-19 *Lock MC67 to Trigger Handle*

Removing the MC67

1. To remove the MC67, press the release buttons.

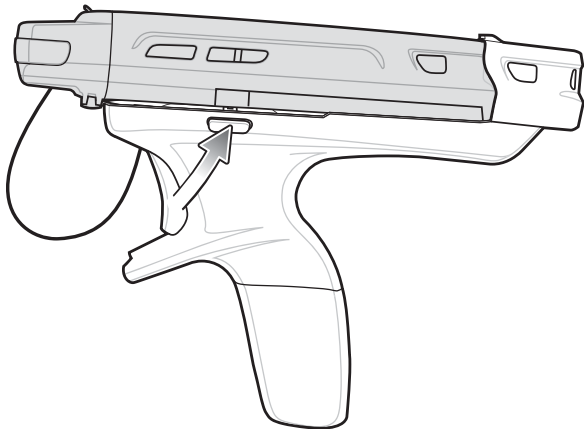

Figure 7-20 *Press Release Tab*

2. Rotate the MC67 upward.

Scanning

A scanning application must be installed prior to scanning a bar code.

1. Start the MC67's scanning application.
2. Aim the MC67 at the bar code.

3. Press the trigger on the handle. The Scan/Decode LED lights and a beep sounds to indicate a successful decode.

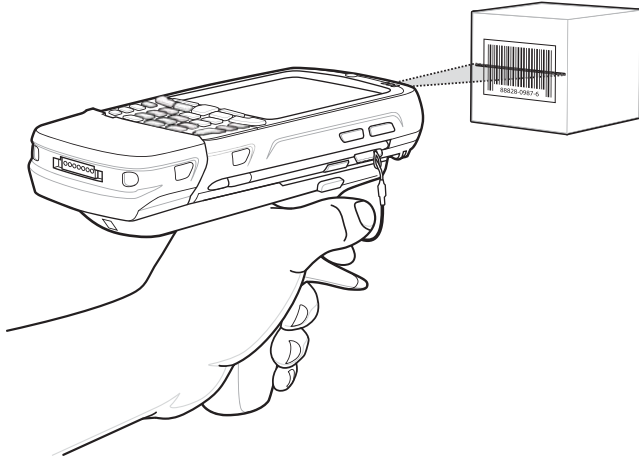

Figure 7-21 *Scanning with the Trigger Handle*

CHAPTER 8 MAINTENANCE AND TROUBLESHOOTING

This chapter includes instructions on cleaning and storing the device, and provides troubleshooting solutions for potential problems during operation.

Maintaining the MC67

For trouble-free service, observe the following tips when using the MC67:

- Do not scratch the screen of the MC67. When working with the MC67, use the supplied stylus or plastic-tipped pens intended for use with a touch-sensitive screen. Never use an actual pen or pencil or other sharp object on the surface of the MC67 screen. We recommend using a screen protector, p/n KT-129195-01R.
- The touch-sensitive screen of the MC67 is glass. Do not drop the MC67 or subject it to strong impact.
- Protect the MC67 from temperature extremes. Do not leave it on the dashboard of a car on a hot day, and keep it away from heat sources.
- Do not store or use the MC67 in any location that is dusty, damp, or wet.
- Use a soft lens cloth to clean the MC67. If the surface of the MC67 screen becomes soiled, clean it with a soft cloth moistened with a diluted window-cleaning solution.
- Periodically replace the rechargeable battery to ensure maximum battery life and product performance. Battery life depends on individual usage patterns.
- A screen protector is applied to the MC67. We recommend using this to minimize wear and tear. Screen protectors enhance the usability and durability of touch screen displays. Benefits include:
 - Protection from scratches and gouges
 - Durable writing and touch surface with tactile feel
 - Abrasion and chemical resistance
 - Glare reduction
 - Keeping the device's screen looking new
 - Quick and easy installation.

Removing the Screen Protector

A screen protector is applied to the MC67. We recommend using this to minimize wear and tear. Screen protectors enhance the usability and durability of touch screen displays.

To remove the screen protector, lift the corner using a thin plastic card, such as a credit card, then carefully lift it off the display.



Figure 8-1 Removing the Screen Protector



CAUTION Do not use a sharp object to remove the protector. Doing so can damage the touch panel.



NOTE Not using a screen protector can affect warranty coverage. To purchase replacement protectors, contact a local account manager. These include screen protector installation instructions. Part number: KT-129195-01R Screen Protector 3/pk.

Battery Safety Guidelines

- The area in which the units are charged should be clear of debris and combustible materials or chemicals. Particular care should be taken where the device is charged in a non commercial environment.
- Follow battery usage, storage, and charging guidelines found in this guide.
- Improper battery use may result in a fire, explosion, or other hazard.
- To charge the mobile device battery, the battery and charger temperatures must be between +32 °F and +104 °F (0 °C and +40 °C)
- To charge the mobile device battery, the battery and charger temperatures must be between 0 °C and +45 °C (+32 °F and +113 °F)
- Do not use incompatible batteries and chargers. Use of an incompatible battery or charger may present a risk of fire, explosion, leakage, or other hazard. If you have any questions about the compatibility of a battery or a charger, contact the Global Customer Support Center.
- For devices that utilize a USB port as a charging source, the device shall only be connected to products that bear the USB-IF logo or have completed the USB-IF compliance program.
- To enable authentication of an approved battery, as required by IEEE1725 clause 10.2.1, all batteries will carry a hologram. Do not fit any battery without checking it has the authentication hologram.
- Do not disassemble or open, crush, bend or deform, puncture, or shred.

- Severe impact from dropping any battery-operated device on a hard surface could cause the battery to overheat.
- Do not short circuit a battery or allow metallic or conductive objects to contact the battery terminals.
- Do not modify or remanufacture, attempt to insert foreign objects into the battery, immerse or expose to water or other liquids, or expose to fire, explosion, or other hazard.
- Do not leave or store the equipment in or near areas that might get very hot, such as in a parked vehicle or near a radiator or other heat source. Do not place battery into a microwave oven or dryer.
- Battery usage by children should be supervised.
- Please follow local regulations to properly dispose of used re-chargeable batteries.
- Do not dispose of batteries in fire.
- In the event of a battery leak, do not allow the liquid to come in contact with the skin or eyes. If contact has been made, wash the affected area with large amounts of water and seek medical advice.
- If you suspect damage to your equipment or battery, contact the Global Customer Support Center to arrange for inspection.

Cleaning Instructions



CAUTION Always wear eye protection.



NOTE Read warning label on compressed air and alcohol product before using.

If you have to use any other solution for medical reasons please contact the Customer Support for more information.



WARNING! Avoid exposing this product to contact with hot oil or other flammable liquids. If such exposure occurs, unplug the device and clean the product immediately in accordance with these guidelines.

Approved Cleanser Active Ingredients

100% of the active ingredients in any cleaner must consist of one or some combination of the following: isopropyl alcohol, bleach/sodium hypochlorite, hydrogen peroxide or mild dish soap.

Harmful Ingredients

The following chemicals are known to damage the plastics on the device and should not come in contact with the device: ammonia solutions, compounds of amines or ammonia; acetone; ketones; ethers; aromatic and chlorinated hydrocarbons; aqueous or alcoholic alkaline solutions; ethanolamine; toluene; trichloroethylene; benzene; carbolic acid and TB-lysoform.

Cleaning Instructions

Do not apply liquid directly to the device. Dampen a soft cloth or use pre-moistened wipes. Do not wrap the device in the cloth or wipe, but gently wipe the unit. Be careful not to let liquid pool around the display window or other places. Allow the unit to air dry before use.

Special Cleaning Notes

Many vinyl gloves contain phthalate additives, which are often not recommended for medical use and are known to be harmful to the housing of the device. The device should not be handled while wearing vinyl gloves containing phthalates, or before hands are washed to remove contaminant residue after gloves are removed. If products containing any of the harmful ingredients listed above are used prior to handling the device, such as hand sanitizer that contain ethanalamine, hands must be completely dry before handling the device to prevent damage to the plastics.

Cleaning Materials Required

- Alcohol wipes
- Lens tissue
- Cotton-tipped applicators
- Isopropyl alcohol
- Can of compressed air with a tube.

Cleaning Frequency

The cleaning frequency is up to the customer's discretion due to the varied environments in which the mobile devices are used. They may be cleaned as frequently as required, but it is advisable to clean the camera window periodically when used in dirty environments to ensure optimum performance.

Approved Cleanser Active Ingredients

100% of the active ingredients in any cleaner must consist of one or some combination of the following: isopropyl alcohol, bleach/sodium hypochlorite, hydrogen peroxide or mild dish soap.

Harmful Ingredients

The following chemicals are known to damage the plastics on the device and should not come in contact with the device: ammonia solutions, compounds of amines or ammonia; acetone; ketones; ethers; aromatic and chlorinated hydrocarbons; aqueous or alcoholic alkaline solutions; ethanalamine; toluene; trichloroethylene; benzene; carboric acid and TB-lysoform.

Cleaning Instructions

Do not apply liquid directly to the device. Dampen a soft cloth or use pre-moistened wipes. Do not wrap the device in the cloth or wipe, but gently wipe the unit. Be careful not to let liquid pool around the display window or other places. Allow the unit to air dry before use.

Special Cleaning Notes

Many vinyl gloves contain phthalate additives, which are often not recommended for medical use and are known to be harmful to the housing of the device. The device should not be handled while wearing vinyl gloves containing phthalates, or before hands are washed to remove contaminant residue after gloves are removed. If products containing any of the harmful ingredients listed above are used prior to handling the device, such as hand sanitizer that contain ethanolamine, hands must be completely dry before handling the device to prevent damage to the plastics.

Cleaning Materials Required

- Alcohol wipes
- Lens tissue
- Cotton-tipped applicators
- Isopropyl alcohol
- Can of compressed air with a tube.

Cleaning the MC67

Housing

Using the alcohol wipes, wipe the housing including buttons.

Display

The display can be wiped down with the alcohol wipes, but care should be taken not to allow any pooling of liquid around the edges of the display. Immediately dry the display with a soft, non-abrasive cloth to prevent streaking.

Camera and Exit Window

Wipe the camera and exit window periodically with a lens tissue or other material suitable for cleaning optical material such as eyeglasses.

Connector Cleaning

To clean the connectors:

1. Remove the main battery from mobile computer.
2. Dip the cotton portion of the cotton-tipped applicator in isopropyl alcohol.
3. Rub the cotton portion of the cotton-tipped applicator back-and-forth across the connector. Do not leave any cotton residue on the connector.
4. Repeat at least three times.
5. Use the cotton-tipped applicator dipped in alcohol to remove any grease and dirt near the connector area.
6. Use a dry cotton-tipped applicator and repeat steps 4 through 6.



CAUTION Do not point nozzle at yourself and others, ensure the nozzle or tube is away from your face.

7. Spray compressed air on the connector area by pointing the tube/nozzle about ½ inch away from the surface.
8. Inspect the area for any grease or dirt, repeat if required.

Cleaning Cradle Connectors

To clean the connectors on a cradle:

1. Remove the DC power cable from the cradle.
2. Dip the cotton portion of the cotton-tipped applicator in isopropyl alcohol.
3. Rub the cotton portion of the cotton-tipped applicator along the pins of the connector. Slowly move the applicator back-and-forth from one side of the connector to the other. Do not leave any cotton residue on the connector.
4. All sides of the connector should also be rubbed with the cotton-tipped applicator.



CAUTION Do not point nozzle at yourself and others, ensure the nozzle or tube is pointed away from your face.

5. Spray compressed air in the connector area by pointing the tube/nozzle about ½ inch away from the surface.
6. Remove any lint left by the cotton-tipped applicator.
7. If grease and other dirt can be found on other areas of the cradle, use a lint-free cloth and alcohol to remove.
8. Allow at least 10 to 30 minutes (depending on ambient temperature and humidity) for the alcohol to air dry before applying power to cradle.

If the temperature is low and humidity is high, longer drying time is required. Warm temperature and dry humidity requires less drying time.

Troubleshooting

The following tables provides typical problems that might arise and the solution for correcting the problem.

MC67

Table 8-1 *Troubleshooting the MC67*

Problem	Cause	Solution
When pressing the power button the MC67 does not turn on.	Battery not charged.	Charge or replace the battery in the MC67.
	Battery not installed properly.	Install the battery properly. See Installing the Battery.
	System crash.	Perform a reset. See Resetting the AndroidDevice.
When pressing the power button the MC67 does not turn on but two LEDs blink.	Battery charge is at a level where data is maintained but battery should be re-charged.	Charge or replace the battery in the MC67.

Table 8-1 *Troubleshooting the MC67 (Continued)*

Problem	Cause	Solution
Battery did not charge.	Battery failed.	Replace battery. If the MC67 still does not operate, perform a reset. See <i>Resetting the AndroidDevice</i> .
	MC67 removed from cradle while battery was charging.	Insert MC67 in cradle. The 3600 mAh battery fully charges in less than six hours.
	Extreme battery temperature.	Battery does not charge if ambient temperature is below 0°C (32°F) or above 40°C (104°F).
Cannot see characters on display.	MC67 not powered on.	Press the Power button.
During data communication with a host computer, no data transmitted, or transmitted data was incomplete.	MC67 removed from cradle or disconnected from host computer during communication.	Replace the MC67 in the cradle, or reattach the communication cable and re-transmit.
	Incorrect cable configuration.	See the system administrator.
	Communication software was incorrectly installed or configured.	Perform setup. Refer to the <i>MC67 Integrator Guide</i> for details.
During data communication over Wi-Fi, no data transmitted, or transmitted data was incomplete.	Wi-Fi radio is not on.	Turn on the Wi-Fi radio.
	You moved out of range of an access point.	Move closer to an access point.
During data communication over Bluetooth, no data transmitted, or transmitted data was incomplete.	Bluetooth radio is not on.	Turn on the Bluetooth radio.
	You moved out of range of another Bluetooth device.	Move within 10 meters (32.8 feet) of the other device.
During data communication over WAN, no data transmitted, or transmitted data was incomplete.	You are in an area of poor cellular service.	Move to an area that has better service.
	APN is not set up correct.	See system administrator for APN setup information.
	SIM card not installed properly.	Remove and re-install the SIM card.
No sound.	Volume setting is low or turned off.	Adjust the volume.

Table 8-1 Troubleshooting the MC67 (Continued)



Problem	Cause	Solution
MC67 shuts off.	MC67 is inactive.	The display turns off after a period of inactivity. Set this period to 15 seconds, 30 seconds, 1, 2, 10 or 30 minutes.
	Battery is depleted.	Replace the battery.
	Battery is not inserted properly.	Insert the battery properly. See Installing the Battery.
Tapping the window buttons or icons does not activate the corresponding feature.	The device is not responding.	Reset the device. See Resetting the Android Device.
A message appears stating that the MC67 memory is full.	Too many files stored on the MC67.	Delete unused memos and records. If necessary, save these records on the host computer (or use an SD card for additional memory).
	Too many applications installed on the MC67.	Remove user-installed applications on the MC67 to recover memory. Select  >  >  Apps > Downloaded . Select the unused program and tap Remove .
The MC67 does not decode with reading bar code.	Scanning application is not loaded.	Load a scanning application on the MC67 or enable DataWedge. See the system administrator.
	Unreadable bar code.	Ensure the symbol is not defaced.
	Distance between exit window and bar code is incorrect.	Place the MC67 within proper scanning range.
	MC67 is not programmed for the bar code.	Program the MC67 to accept the type of bar code being scanned. Refer to the EMDK or DataWedge application.
	MC67 is not programmed to generate a beep.	If the MC67 does not beep on a good decode, set the application to generate a beep on good decode.
	Battery is low.	If the scanner stops emitting a laser beam upon a trigger press, check the battery level. When the battery is low, the scanner shuts off before the MC67 low battery condition notification. Note: If the scanner is still not reading symbols, contact us or a distributor.
	User is trying to decode a DPM bar code.	An MC67 with a DPM imager is required. Contact system administrator.
Error message "SIM Error. Cannot save information to the SIM" appears when copying contacts to a SIM card.	Feature not supported on some SIM cards.	If error appears while copying one contact, reboot the MC67. The contact appears on the SIM card after rebooting.
		If error appears while copying multiple contacts, copy one contact at a time and follow above solution.
		Use Microsoft Outlook Exchange and ActiveSync to synchronize contacts with Microsoft Outlook on host computer.

Table 8-1 *Troubleshooting the MC67 (Continued)*

Problem	Cause	Solution
MC67 cannot find any Bluetooth devices nearby.	Too far from other Bluetooth devices.	Move closer to the other Bluetooth device(s), within a range of 10 meters (32.8 feet).
	The Bluetooth device(s) nearby are not turned on.	Turn on the Bluetooth device(s) to find.
	The Bluetooth device(s) are not in discoverable mode.	Set the Bluetooth device(s) to discoverable mode. If needed, refer to the device's user documentation for help.
Cannot unlock MC67.	User enters incorrect password.	If the user enters an incorrect password eight times, the user is requested to enter a code before trying again. If the user forgot the password, contact system administrator.

Single Slot USB Cradle

Table 8-2 *Troubleshooting the Single Slot USB Cradle*

Symptom	Possible Cause	Action
LEDs do not light when MC67 or spare battery is inserted.	Cradle is not receiving power.	Ensure the power cable is connected securely to both the cradle and to AC power.
	MC67 is not seated firmly in the cradle.	Remove and re-insert the MC67 into the cradle, ensuring it is firmly seated.
	Spare battery is not seated firmly in the cradle.	Remove and re-insert the spare battery into the charging slot, ensuring it is firmly seated.
MC67 battery is not charging.	MC67 was removed from cradle or cradle was unplugged from AC power too soon.	Ensure cradle is receiving power. Ensure MC67 is seated correctly. Confirm the main battery is charging. The 3600 mAh battery fully charges in less than six hours.
	Battery is faulty.	Verify that other batteries charge properly. If so, replace the faulty battery.
	The MC67 is not fully seated in the cradle.	Remove and re-insert the MC67 into the cradle, ensuring it is firmly seated.
	Extreme battery temperature.	Battery does not charge if ambient temperature is below 0°C (32°F) or above 40°C (104°F).
Spare battery is not charging.	Battery not fully seated in charging slot.	Remove and re-insert the spare battery in the cradle, ensuring it is firmly seated.
	Battery inserted incorrectly.	Re-insert the battery so the charging contacts on the battery align with the contacts on the cradle.
	Battery is faulty.	Verify that other batteries charge properly. If so, replace the faulty battery.

Table 8-2 *Troubleshooting the Single Slot USB Cradle*

Symptom	Possible Cause	Action
During data communication, no data transmits, or transmitted data was incomplete.	MC67 removed from cradle during communications.	Replace MC67 in cradle and retransmit.
	Communication software is not installed or configured properly.	Perform setup as described in the <i>MC67 Integrator Guide</i> .

Four Slot Charge Only Cradle

Table 8-3 *Troubleshooting the Four Slot Charge Only Cradle*

Symptom	Cause	Solution
Battery is not charging.	MC67 removed from the cradle too soon.	Replace the MC67 in the cradle. The 3600 mAh battery fully charges in less than six hours.
	Battery is faulty.	Verify that other batteries charge properly. If so, replace the faulty battery.
	MC67 is not inserted correctly in the cradle.	Remove the MC67 and reinsert it correctly. Verify charging is active.
	Ambient temperature of the cradle is too warm.	Move the cradle to an area where the ambient temperature is between 0 °C (32 °F) and 35 °C (95 °F).

Four Slot Ethernet Cradle

Table 8-4 *Troubleshooting the Four Slot Ethernet Cradle*

Symptom	Cause	Solution
During communication, no data transmits, or transmitted data was incomplete.	MC67 removed from cradle during communications.	Replace MC67 in cradle and retransmit.
	MC67 has no active connection.	An icon is visible in the status bar if a connection is currently active.
Battery is not charging.	MC67 removed from the cradle too soon.	Replace the MC67 in the cradle. The 3600 mAh battery fully charges in less than six hours.
	Battery is faulty.	Verify that other batteries charge properly. If so, replace the faulty battery.
	MC67 is not inserted correctly in the cradle.	Remove the MC67 and reinsert it correctly.
	Ambient temperature of the cradle is too warm.	Move the cradle to an area where the ambient temperature is between 0°C (32°F) and 50°C (122°F).

Vehicle Cradle

Table 8-5 *Troubleshooting the Vehicle Cradle*

Symptom	Possible Cause	Action
MC67 battery charging LED does not light up.	Cradle is not receiving power.	Ensure the power input cable is securely connected to the cradle's power port.
MC67 battery is not recharging.	MC67 was removed from the cradle too soon.	Replace the MC67 in the cradle. The 3600 mAh battery fully charges in less than six hours.
	Battery is faulty.	Replace the battery.
	MC67 is not placed correctly in the cradle.	Remove the MC67 from the cradle, and re-insert correctly. If the battery still does not charge, contact customer support. The MC67 battery charging LED slowly blinks amber when the MC67 is correctly inserted and charging.
	Ambient temperature of the cradle is too warm.	Move to an area where the ambient temperature is between -20 °C and 50 °C 50 °C (-4 °F and 122 °F).

Four Slot Battery Charger

Table 8-6 *Troubleshooting The Four Slot Battery Charger*

Symptom	Possible Cause	Action
Battery not charging.	Battery was removed from the charger or charger was unplugged from AC power too soon.	Re-insert the battery in the charger or re-connect the charger's power supply. The 3600 mAh battery fully charges in less than six hours.
	Battery is faulty.	Verify that other batteries charge properly. If so, replace the faulty battery.
	Battery contacts not connected to charger.	Verify that the battery is seated in the battery well correctly with the contacts facing down.

Cables

Table 8-7 *Troubleshooting the Cables*

Symptom	Possible Cause	Action
MC67 battery is not charging.	MC67 was disconnected from AC power too soon.	Connect the power cable correctly. Confirm main battery is charging. The 3600 mAh battery fully charges in less than six hours.
	Battery is faulty.	Verify that other batteries charge properly. If so, replace the faulty battery.
	The MC67 is not fully attached to power.	Detach and re-attach the power cable to the MC67, ensuring it is firmly connected.

Table 8-7 *Troubleshooting the Cables*

Symptom	Possible Cause	Action
During data communication, no data transmits, or transmitted data was incomplete.	Cable was disconnected from MC67 during communications.	Re-attach the cable and retransmit.
	Incorrect cable configuration.	See the system administrator.
	Communication software is not installed or configured properly.	Perform setup as described in the <i>MC67 Integrator Guide</i> .

Magnetic Stripe Reader

Table 8-8 *Troubleshooting the Magnetic Stripe Reader*

Symptom	Possible Cause	Action
MSR cannot read card.	MSR removed from MC67 during card swipe.	Reattach MSR to MC67 and reswipe the card.
	Faulty magnetic stripe on card.	Try another card. If condition still exist, contact the system administrator.
	Swipe speed is too fast or too slow.	Re-swipe card using a constant swipe speed.
	MSR application is not installed or configured properly.	Ensure the MSR application is installed on the MC67. Ensure the MSR application is configured correctly.
MC67 battery is not charging.	MC67 was removed from MSR or MSR was unplugged from AC power too soon.	Ensure MSR is receiving power. Ensure MC67 is attached correctly. Confirm main battery is charging. The 3600 mAh battery fully charges in less than six hours.
	Battery is faulty.	Verify that other batteries charge properly. If so, replace the faulty battery.
	The MC67 is not fully attached to the MSR.	Detach and re-attach the MSR to the MC67, ensuring it is firmly connected.
During data communication, no data transmits, or transmitted data was incomplete.	MC67 detached from MSR during communications.	Reattach MC67 to MSR and retransmit.
	Incorrect cable configuration.	See the system administrator.
	Communication software is not installed or configured properly.	Perform setup as described in the <i>MC67 Integrator Guide</i> .

CHAPTER A TECHNICAL SPECIFICATIONS

The following sections provide technical specification for the device.

MC67

Table A-1 *MC67 Technical Specifications*

Item	Description
Physical Characteristics	
Dimensions	Height: 16.2 cm (6.38 in.) Width: 7.7 cm (3.03 in.) Depth: 3.35 cm (1.32 in.)
Weight	385 g (13.5 oz.)
Display	Color 3.5" video graphics adapter (VGA) with backlight, 65K colors, 480 W x 640 L
Touch Panel	Glass analog resistive touch
Backlight	Light Emitting Diode (LED) backlight
Battery Pack	Rechargeable Lithium Ion 3.7V, 3600 mAh battery
Backup battery	Nickel–metal hydride (Ni-MH) battery (rechargeable) 15 mAh 2.8V (non-user accessible or replaceable)
Expansion Slot	micro Secure Digital (SD) slot (supports up to 32 GB)
Connection Interface	Universal Serial Bus (USB) 2.0 High Speed (host and client)
Notification	Audible tone plus multi-color LEDs
Keypad Options	numeric, alphanumeric (QWERTY, AZERTY, QWERTZ) and Direct Store Delivery (DSD)
Audio	Dual microphone support with noise cancellation; vibrate alert; speaker; Bluetooth headset

Table A-1 MC67 Technical Specifications (Continued)

Item	Description
Performance Characteristics	
CPU	Dual-core OMAP 4, 1 GHz
Operating System	Android-based AOSP V4.4.4
Memory	1 GB Random Access Memory (RAM)/8 GB Flash, 4 GB microSD card
Output Power	USB - 5 VDC @ 300 mA max
User Environment	
Operating Temperature	-20°C to 50°C (-4°F to 122°F)
Storage Temperature	-40°C to 70°C (-40°F to 158°F)
Charging Temperature	0° C to 40° C (32°F to 104°F)
Humidity	5 to 85% non-condensing
Drop Specification	Multiple 2.4 m (8 ft.) drops per MIL-STD 810G at room temperature. 1.8 m (6 ft.) across operating temperature per MIL-STD 810G
Tumble	1,000 1.6 ft./0.5 meter tumbles at room temperature; per applicable IEC tumble specifications
Electrostatic Discharge (ESD)	+/-15kVdc air discharge, +/-8kVdc direct discharge, +/-8kVdc indirect discharge
Sealing	IP65 and IP67 per IEC specification.
Vibration	4 g's PK Sine (5 Hz to 2 kHz); 0.04g ² /Hz Random (20 Hz to 2 kHz); 60 minute duration per axis, 3 axis
Thermal Shock	-40° C to 70° C (-40° F to 158° F) rapid transition
Interactive Sensor Technology (IST)	
Motion Sensor	3-axis accelerometer provides motion-sensing for dynamic screen orientation and power management
Light Sensor	Ambient light sensor to auto adjust display backlight brightness
Digital Compass	Navigation aid for users
Wireless WAN Data and Voice Communications	
Radio	4G HSPA+
Frequency Band	UMTS/HSDPA and HSUPA: 850, 900, 1900 and 2100 MHz GSM/EDGE: 850, 900, 1800 and 1900 MHz
Wireless LAN Data and Voice Communications	
Radio	IEEE® 802.11a/b/g/n

Table A-1 MC67 Technical Specifications (Continued)

Item	Description
Data Rates Supported	1, 2, 5.5, 6, 9, 11, 12, 18, 24, 36, 48, and 54 Mbps
Operating Channels	Chan 36 - 165 (5180 - 5825 MHz) Chan 1 - 13 (2412 - 2472 MHz) Chan 14 (2484 MHz) Japan only Actual operating channels/frequencies depend on regulatory rules and certification agency
Security	Security Modes: Legacy, WPA and WPA2 Encryption: WEP (40 and 128 bit), TKIP and AES Authentication: LEAP, EAP-FAST (MS-CHAPv2, GTC), PEAP (MSCHAPv2, EAP-GTC), TLS, TTLS (PAP, MS-CHAP, MS-CHAPv2)
Voice Communications	Voice-over-IP ready, Wi-Fi™-certified, IEEE 802.11a/b/g/n direct sequence wireless LAN, Wi-Fi Multimedia™ (WMM and WMM-PS)
Wireless PAN Data and Voice Communications	
Bluetooth	Class II, v2.1 with Enhanced Data Rate (EDR)
Global Positioning System	
GPS	Integrated stand-alone or Assisted-GPS (A-GPS)
Data Capture Specifications	
2D Imager	SE4500-SR
Data Types	1D and 2D bar codes, photographs, video, signatures and documents.
Voice and Audio	
VoWWAN; VoWLAN; PTT-ready, VoIP-ready; high-quality speakerphone; wireless (Bluetooth) headset support; headset/speakerphone modes	
2D Imager Engine (SE4500-SR) Specifications	
Field of View	Horizontal - 39.6° Vertical - 25.7°
Optical Resolution	WVGA 752 H x 480 V pixels (gray scale)
Roll	360°
Pitch Angle	+/- 60° from normal
Skew Tolerance	+/- 60° from normal
Ambient Light	Indoor: 450 ft. candles (4845 lux) Outdoor: 9000 ft. candles (96,900 lux) Sunlight: 8000 ft. candles Fluorescent: 450 ft. candles

Table A-1 MC67 Technical Specifications (Continued)

Item	Description
Focal Distance	From center of exit window: 19 cm (7.5 in.)
Aiming Element (VLD)	655 nm +/- 10 nm
Illumination Element (LED)	625 nm +/- 5 nm
Camera Specifications	
Resolution	8 Mega pixel

Table A-2 Data Capture Supported Symbologies

Item	Description
1D Bar Codes	Chinese 2 of 5, Code 128, Coupon Code, EAN-13, GS1 DataBar Expanded, GS1 DataBar Limited, Korean 2 of 5, TLC39, UPCA, UPC/EAN Supplementals, Codabar, Code 39, Discrete 2 of 5, GS1 DataBar, GS1 DataBar Expanded Stacked, Interleaved 2 of 5, Matrix 2 of 5, Trioptic 39, UPCE, Webcode, Code 11, Code 93, EAN-8, GS1 DataBar 14, ISBT 128, MSI, UCC/EAN 128, UPCE1
2D Bar Codes	Australian Postal, Composite AB, Dutch Postal, Maxi Code, PDF-417, UK Postal, Aztec, Composite C, Japanese Postal, Micro PDF-417, QR Code, US Postnet, Canadian Postal, Data Matrix, Linked Aztec, microQR, US Planet, USPS 4-state (US4CB),

CHAPTER B KEYPADS

The MC67 offers three types of keypad configurations: Numeric, alpha-numeric QWERTY, and DSD.

Numeric Keypad Configuration

The numeric keypad contains application keys, scroll keys, and function keys. The keypad is color-coded to indicate the alternate function key (blue) values. Note that an application can change keypad functions so the MC67's keypad may not function exactly as described. See the tables below for key and button descriptions and for the keypad's special functions.

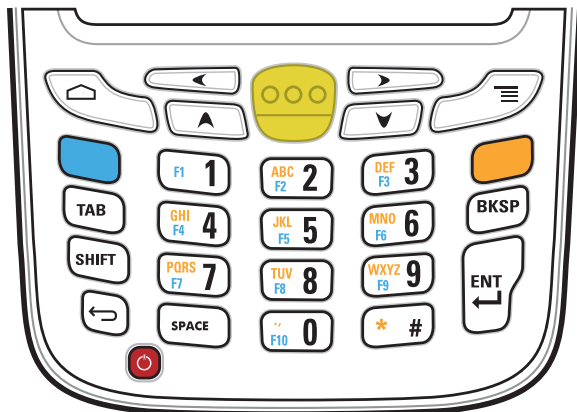

Figure B-1 MC67 Numeric Keypad

Table B-1 MC67 Numeric Keypad Descriptions











Key	Description
Blue Key 	Use the Blue key to access items shown on the keypad in blue. Press the Blue key once followed by another key. A single press illuminates the key until the second key is pressed.
Orange Key 	Use this key to access the secondary layer of characters shown on the keypad in orange. Press the Orange key to lock the keypad into Alpha state. The Orange key illuminates when in this state. Press the Orange key again to return to the numeric state. Press the Orange key, then the Shift key to add a shift (that applies only to the next key pressed) to the orange lock state.
SHIFT 	Press and release the SHIFT key to activate the keypad alternate SHIFT state. Press the Orange key and then the Shift key to produce uppercase characters.
Scan (yellow) 	Activates the imager in a scan enabled application or takes a picture or records a video in a camera application.
Home 	Displays the Home screen with a single press. Displays recently used applications when held for a short period of time.
Menu 	Opens a menu with items that affect the current screen or application.
Back 	Displays the previous screen. Closes the on-screen keyboard if open.
Scroll Left 	Moves left one item. Note: disabled when Shift key is pressed.
Scroll Right 	Moves right one item. Note: disabled when Shift key is pressed.
Scroll Up 	Moves up one item. Note: disabled when Shift key is pressed.
Scroll Down 	Moves down one item. Note: disabled when Shift key is pressed.

Table B-1 MC67 Numeric Keypad Descriptions (Continued)



Key	Description
Alphanumeric 	<p>In the default Numeric state, produces the numeric value on the key.</p> <p>In Alpha state, produces the lower case alphabetic characters on the key. Each key press produces the next alphabetic character in sequence. For example, press and release the Orange key and then press the '4' key once to produce the letter 'g'; press and release the Orange key and then press the '4' key three times to produce the letter 'i'.</p> <p>Press the SHIFT key in the Alpha state to produce the upper case characters on the key. For example, press and release the Orange key, press and release the SHIFT key and then press the '7' key once to produce the letter 'S'; press and release the Orange key, press and release the SHIFT key and then press the '7' key three times to produce the letter 'S'.</p>
Backspace 	Deletes the previous character.
Enter 	Executes a selected item or function.

Table B-2 Numeric Keypad Input States

Key	Numeric State			Orange Key (Alpha State)				Orange Key + Shift Key (Alpha Uppercase State)			
		Blue + Key	SHIFT + Key	1st Press	2nd Press	3rd Press	4th Press	1st Press	2nd Press	3rd Press	4th Press
1	1	F1	!								
2	2	F2	@	a	b	c		A	B	C	
3	3	F3	#	d	e	f		D	E	F	
4	4	F4	\$	g	h	i		G	H	I	
5	5	F5	%	j	k	l		J	K	L	
6	6	F6	^	m	n	o		M	N	O	
7	7	F7	&	p	q	r	s	P	Q	R	S
8	8	F8	*	t	u	v		T	U	V	
9	9	F9	(w	x	y	z	W	X	Y	Z
0	0	F10)	.	,			.	,		
#	#	#	.	*				*			

NOTE An application can change the key functions. The keypad may not function exactly as described.

Alpha-numeric Keypad Configurations

The three types of alpha-numeric keypads (QWERTY, AZERTY and QWERTZ) produce the 26-character alphabet (A-Z, both lowercase and uppercase), numbers (0-9), and assorted characters. The keypad is color-coded to indicate which modifier key to press to produce a particular character or action. The keypad default is alphabetic, producing lowercase letters. See the tables below for key and button descriptions and for the keypad's special functions. AZERTY keypad is used on configurations installed with the French operating system. QWERTZ keypad is used on configurations installed with the German operating system.



Figure B-2 QWERTY Keypad Configuration



Figure B-3 AZERTY Keypad Configuration



Figure B-4 QWERTZ Keypad Configuration

Table B-3 Alpha-numeric Keypad Descriptions









Key	Description
Green Key 	Press to display the Phone application. After entering a phone number, press to initiate the call. Press to answer an incoming call.
Red Key 	Press to stop dialing or end a call.
Orange Key 	Accesses the secondary layer of characters and actions (shown on the keypad in orange). Press the Orange key once to activate this state temporarily, followed by another key. Press the Orange key twice to lock this state. Press the Orange key a third time to unlock.
Home 	Displays the Home screen with a single press. Displays recently used applications when held for a short period of time.
Scan (yellow) 	Activates the imager in a scan enabled application or takes a picture or records a video in a camera application.
Menu 	Opens a menu with items that affect the current screen or application.
Scroll Left 	Moves left one item. Note: disabled when Shift key is pressed.
Scroll Right 	Moves right one item. Note: disabled when Shift key is pressed.

Table B-3 Alpha-numeric Keypad Descriptions (Continued)







Key	Description
Scroll Up 	Moves up one item. Note: disabled when Shift key is pressed.
Scroll Down 	Moves down one item. Note: disabled when Shift key is pressed.
Shift 	Changes the state of the alpha characters from lowercase to uppercase. Press the Shift key to activate this state temporarily, followed by another key.
Back 	Displays the previous screen. Closes the on-screen keyboard if open.
Backspace 	Produces a backspace.
Enter 	Executes a selected item or function.

Table B-4 QWERTY Keypad Input States

Key	Normal	Shift + Key	Orange + Key
Q	q	Q	*
W	w	W	1
E	e	E	2
R	r	R	3
T	t	T	+
Y	y	Y	-
U	u	U	-
I	i	I	=
O	o	O	"
P	p	P	
A	a	A	#
S	s	S	4
D	d	D	5

NOTE An application can change the key functions. The keypad may not function exactly as described.

Table B-4 QWERTY Keypad Input States (Continued)

Key	Normal	Shift + Key	Orange + Key
F	f	F	6
G	g	G	(
H	h	H)
J	j	J	/
K	k	K	:
L	l	L	'
Z	z	Z	7
X	x	X	8
C	c	C	9
V	v	V	%
B	b	B	&
N	n	N	!
M	m	M	?
,	,	<	@
TAB	Tab	Tab	0
. (Period)	.	.	:

NOTE An application can change the key functions. The keypad may not function exactly as described.

DSD Keypad Configuration

The Direct Store Delivery (DSD) keypad contains application keys, scroll keys, and function keys. The keypad is color-coded to indicate the alternate function key (blue) values. Note that an application can change keypad functions so the MC67's keypad may not function exactly as described. See the tables below for key and button descriptions and for the keypad's special functions.

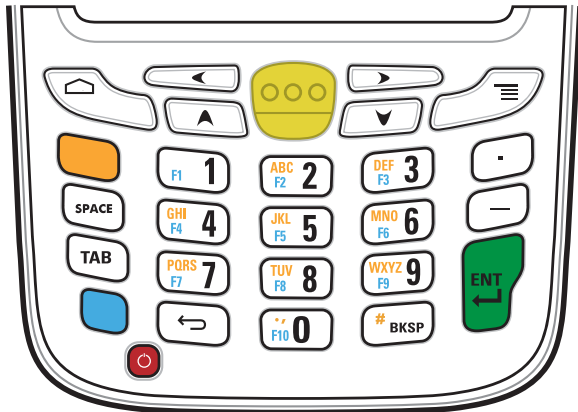

Figure B-5 DSD Keypad Descriptions

Table B-5 MC67 DSD Keypad Descriptions







Key	Description
Blue Key 	Use the Blue key to access items shown on the keypad in blue. Press the Blue key once followed by another key. A single press illuminates the key until the second key is pressed. Press the Blue key twice to lock the keypad into this state. The Blue key illuminates when in this state. Press the Blue key again to revert back to numeric state.
Orange Key 	Use this key to access the secondary layer of characters shown on the keypad in orange. Press the Orange key to lock the keypad into Alpha state. The Orange key illuminates when in this state. Press the Orange key again to return to the numeric state.
Scan (yellow) 	Activates the imager in a scan enabled application or takes a picture or records a video in a camera application.
Home 	Displays the Home screen with a single press. Displays recently used applications when held for a short period of time.
Menu 	Opens a menu with items that affect the current screen or application.
Back 	Displays the previous screen. Closes the on-screen keyboard if open.
Scroll Left 	Moves left one item. Note: disabled when Shift key is pressed.

Table B-5 MC67 DSD Keypad Descriptions (Continued)











Key	Description
Scroll Right 	Moves right one item. Note: disabled when Shift key is pressed.
Scroll Up 	Moves up one item. Note: disabled when Shift key is pressed.
Scroll Down 	Moves down one item. Note: disabled when Shift key is pressed.
SPACE 	Produces a space character.
Alphanumeric 	In default state, produces the numeric value on the key. In Alpha state, produces the lower case alphabetic characters on the key. Each key press produces the next alphabetic character in sequence. For example, press and release the Orange key and then press the '4' key once to produce the letter 'g'; press and release the Orange key and then press the '4' key three times to produce the letter 'i'.
Backspace 	Produces a backspace.
Period 	Produces a period character.
Tab 	Move from one field to the next.
Dash 	Produces a dash character.
Enter 	Executes a selected item or function.

Table B-6 *DSD Keypad Input States*

Key	Numeric State		Orange Key (Alpha Lowercase State)			
		Blue+ Key	1st Press	2nd Press	3rd Press	4th Press
1	1	F1	*	*	*	*
2	2	F2	a	b	c	
3	3	F3	d	e	f	
4	4	F4	g	h	i	
5	5	F5	j	k	l	
6	6	F6	m	n	o	
7	7	F7	p	q	r	s
8	8	F8	t	u	v	
9	9	F9	w	x	y	z
0	0	F10	.	,		

NOTE An application can change the key functions. The keypad may not function exactly as described.

INDEX

A

adaptive frequency hopping	6-12
adjust volume	3-2
airplane mode	1-10, 1-11
albums	4-9
alphanumeric keypad	xiii
application shortcuts	2-6
applock administrator	2-12
approved cleanser	8-3, 8-4
audio modes	3-1
auto charge cable	7-14

B

backup battery	A-1
battery	1-3, A-1
battery replacement	
replace battery	1-6, 1-7, 1-8
battery status LED	1-2, 2-17
battery usage	1-9
Bluetooth	6-11
PIN	6-12
security	6-12
bluetooth	A-3
Bluetooth call	3-6
Bluetooth headset	3-1, 3-7
browser	2-10

C

cables	8-11
calculator	2-10
calendar	2-10
call barring	3-9
call forwarding	3-8
call waiting	3-9

caller ID	3-9
camera	xiii, 1-3, 2-10
camera flash	1-3
camera settings	4-6
charge only cable	7-14
charging LED	1-2, 2-17
cleaning	8-3
cleaning instructions	8-4
clock	2-10
conference call	3-4
contacts	2-11
CPU	A-2
cradle	
connector cleaning	8-6

D

data capture LED	1-2, 2-17
data capture options	xiii
datawedge	2-10, 5-7
DEX cable	7-14
diagnostics	2-11, 4-20
display	xiii, A-1
cleaning	8-5
downloads	2-10
drop specification	A-2
DSD keypad	xiii
DWDEmo	2-10

E

EAP	6-5
Elemex	4-20
email	2-10
emergency calling	3-1
exit window	1-3

Index - 2 Product Name and Guide Type

F

FAST-GTC	6-5
FAST-MSCHAPv2	6-5
file browser	2-10, 4-1
fixed dialing numbers	3-8
Flash	xiii
font size	1-12
Four Slot Battery Charger	7-9
Four Slot Charge Only Cradle	7-4
Four Slot Ethernet Cradle	7-5

G

gallery	2-10
---------	------

H

handset mode	3-1
handstrap	1-3
harmful ingredients	8-3
headset mode	3-1

I

imager	xiii, A-3
internet calling	3-9

K

keyboard	2-8
keypad	1-2
keypads	xiii, A-1

L

LEAP	6-5
LED indications	2-16
low battery notification	1-10

M

magnetic stripe reader	7-10, 8-12
memory	xiii, A-2
messaging	2-11
microphone	1-2
microSD card	1-7, A-1
multiuser administrator	2-12

N

naming folders	2-7
numeric keypad	xiii

O

operating system	xiii, A-2
------------------	-----------

P

panoramic	4-4
PEAP-GTC	6-5
PEAP-MSCHAPv2	6-5
phone	2-11
power button	1-2

R

radios	xiii
RAM	xiii
recording videos	4-5
replacement	1-7, 1-8
resetting	2-15
ringtone	3-8
RS507 scanning	5-4

S

scan button	1-2
screen font size	1-12
screen lock sound	1-15
screen protector	
removing	8-2
screen rotation	1-12
screen touch notification	1-15
secure storage administrator	2-12
sensors	A-2
set date	1-11
set time	1-11
set time zone	1-11
setting	
camera	4-6
video	4-7
settings	2-11
SIM card	1-8
Single Slot USB Cradle	7-3
SMS	2-11
soft reset	2-15
software version	xiv, 1-xiv
sound recorder	2-11
speaker	1-3
speaker mode	3-1
status bar	2-2
stylus	1-3
sybologies	A-4
system notification	1-15

T

taking a panoramic photo	4-4
taking photos	4-4
TLS	6-5
touch screen	1-2
troubleshooting	8-6, 8-11, 8-12
four slot charge only cradle	8-10
four slot Ethernet cradle	8-10
MC67	8-6
single slot USB cradle	8-9
vehicle cradle	8-11
TTLS	6-5
TTLS-MSCHAP	6-5
TTLS-MSCHAPv2	6-5
TTLS-PAP	6-5

U

USB charging cable	7-13
user guide	2-12
using a Bluetooth headset	3-1
using the dialer	3-2, 3-6

V

vehicle cradle	7-12
vehicle holder	7-17
assembly	7-17
flat surface installation	7-18
windshield installation	7-17
video settings	4-7
videos	4-5
voicemail setup	3-8

W

WAN radio LED	1-2, 2-17
WEP	6-4
WPA	6-4



Zebra Technologies Corporation, Inc.
3 Overlook Point
Lincolnshire, IL 60069, U.S.A.
<http://www.zebra.com>

Zebra and the stylized Zebra head are trademarks of ZIH Corp., registered in many jurisdictions worldwide. All other trademarks are the property of their respective owners.

© 2017 Symbol Technologies LLC, a subsidiary of Zebra Technologies Corporation. All Rights Reserved.

MN002642A02 Revision A - January 2017