

MC70 Enterprise Digital Assistant Integrator Guide

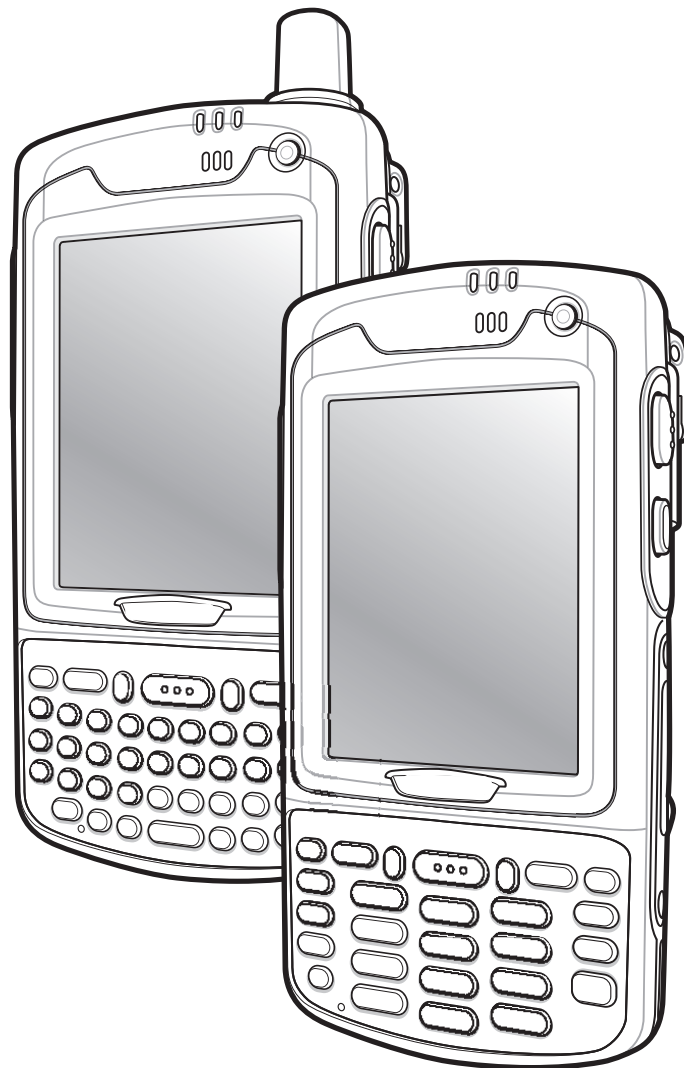

***MC70 Enterprise Digital Assistant
Integrator Guide***

72E-71768-06

Rev. A

July 2015

© 2015 ZIH Corp

No part of this publication may be reproduced or used in any form, or by any electrical or mechanical means, without permission in writing from Zebra. This includes electronic or mechanical means, such as photocopying, recording, or information storage and retrieval systems. The material in this manual is subject to change without notice.

The software is provided strictly on an “as is” basis. All software, including firmware, furnished to the user is on a licensed basis. Zebra grants to the user a non-transferable and non-exclusive license to use each software or firmware program delivered hereunder (licensed program). Except as noted below, such license may not be assigned, sublicensed, or otherwise transferred by the user without prior written consent of Zebra. No right to copy a licensed program in whole or in part is granted, except as permitted under copyright law. The user shall not modify, merge, or incorporate any form or portion of a licensed program with other program material, create a derivative work from a licensed program, or use a licensed program in a network without written permission from Zebra. The user agrees to maintain Zebra’s copyright notice on the licensed programs delivered hereunder, and to include the same on any authorized copies it makes, in whole or in part. The user agrees not to decompile, disassemble, decode, or reverse engineer any licensed program delivered to the user or any portion thereof.

Zebra reserves the right to make changes to any software or product to improve reliability, function, or design.

Zebra does not assume any product liability arising out of, or in connection with, the application or use of any product, circuit, or application described herein.

No license is granted, either expressly or by implication, estoppel, or otherwise under any Zebra, intellectual property rights. An implied license only exists for equipment, circuits, and subsystems contained in Zebra products.

Revision History

Changes to the original manual are listed below:

Change	Date	Description
A	1/2006	Initial release.
B	8/2006	Add Revision History page. Chapter 2: Add vibrator feature information. Remove Green and Red Phone button remapping information. Not supported. Update cold boot procedure to remove step to calibrate screen after cold boot.
-02 Rev A	02/01/07	Add MC7095 information and AKU 3.2 features.
-03 Rev A	09/05/07	Re-Branding, BSP 39.
-04 Rev A	12/20/08	Add Windows Mobile 6.1 support, 3600 mAh and 4800 mAh batteries and remove MSP information and replace with reference to MSP User Guides.
-05 Rev A	04/2015	Zebra re-branding.
-06 Rev A	07/2015	Remove ActiveSync reference in Four Slot Ethernet Cradle Troubleshooting table.

Table of Contents

Revision History	iii
------------------------	-----

Table of Contents

About This Guide

Introduction	xiii
Documentation Set	xiii
Configurations.....	xiv
Software Versions	xv
Chapter Descriptions	xvii
Notational Conventions.....	xviii
Related Documents and Software	xviii
Service Information.....	xix

Chapter 1: Getting Started

Introduction	1-1
Unpacking the EDA	1-1
Accessories	1-2
Getting Started	1-3
Installing and Removing the Main Battery	1-3
Installing the Main Battery	1-3
Removing the Main Battery	1-4
Charging the Battery	1-5
Charging the Main Battery and Memory Backup Battery	1-5
Charging Spare Batteries	1-6
Charging Temperature	1-7
Powering On the EDA	1-7
Calibrating the Screen	1-7
Resetting the EDA	1-7
Performing a Warm Boot	1-7
Performing a Cold Boot	1-7

Performing a Clean Boot	1-8
Waking the EDA	1-8
Locking the EDA	1-9
SIM Card	1-9
Removing the Screen Protector	1-11

Chapter 2: Accessories

Introduction	2-1
Cables	2-1
Cradles	2-1
Miscellaneous	2-1
Snap-on Modules	2-2
Headset	2-2
Multi Media Card (MMC) / Secure Digital (SD) Card	2-2
SD/SDIO Setup	2-3
Single Slot USB/Serial Cradle	2-4
Setup	2-4
Charging the EDA Battery	2-4
Charging the Spare Battery	2-5
Battery Charging Indicators	2-5
Four Slot Ethernet Cradle	2-6
Setup	2-6
Daisy chaining Cradles	2-7
Ethernet Cradle Drivers	2-8
Charging and Communication	2-10
LED Charging Indicators	2-10
Wall Mount Bracket	2-11
VCD7000 Vehicle Cradle	2-12
Requirements	2-13
Connector Ports	2-13
Mounting the Cradle	2-14
Power Connection	2-15
Serial Device Connection	2-17
Charging the EDA Battery	2-17
Charging the Spare Battery	2-18
Battery Charging Indicators	2-19
Four Slot Spare Battery Charger	2-20
Battery Shim Installation	2-20
Spare Battery Charging	2-21
Battery Charging Indicators	2-22
Magnetic Stripe Reader (MSR)	2-23
Attaching and Removing the MSR	2-23
Using the MSR	2-23
TRG7000 Trigger Handle	2-24
Installing the Trigger Handle Cleat	2-24
Inserting the EDA into the Trigger Handle	2-25
Removing the EDA	2-25
Using a Cradle	2-26
Cables	2-27

Setup	2-27
Battery Charging	2-28
LED Charge Indications	2-28
Communication Setup	2-28
Chapter 3: ActiveSync	
Introduction	3-1
Installing ActiveSync	3-1
Mobile Computer Setup	3-2
Setting Up an ActiveSync Connection on the Host Computer	3-2
Synchronization with a Windows Mobile 5.0/6.1 Device	3-3
Chapter 4: Application Deployment for Windows Mobile	
Introduction	4-1
Security	4-1
Application Security	4-1
Digital Signatures	4-1
Device Management Security	4-3
Remote API Security	4-3
Packaging	4-4
Deployment	4-4
Installation Using ActiveSync	4-4
Installation Using Storage Card	4-4
Installation Using AirBEAM	4-5
MSP 3.X	4-5
Image Update	4-5
Creating a Splash Screen	4-6
XML Provisioning	4-6
Creating an XML Provisioning File	4-7
XML Provisioning vs. RegMerge and Copy File	4-7
Storage	4-8
Random Access Memory	4-9
Persistent Storage	4-9
Application Folder	4-9
System Configuration Manager	4-10
File Types	4-10
User Interface	4-10
File Deployment	4-13
Enterprise Mobility Developer Kits	4-13
Chapter 5: MC7004/94 - GSM Configuration	
Introduction	5-1
Quick Startup Steps	5-1
MC7004/94 Service Verification	5-2
Ensuring Network Coverage	5-2
Configuring a GPRS Data Connection	5-3
Establishing a Data Connection	5-5

Ending a GPRS Data Connection	5-6
GPRS Settings	5-7
Phone	5-7
Services	5-9
Network	5-12
Phone Info	5-15
Band	5-16

Chapter 6: MC7095 - CDMA Configuration

Introduction	6-1
Quick Startup Steps	6-1
MC7095 CDMA Phone Activation	6-2
Sprint Activation	6-2
Sprint Activation Test	6-4
Verizon Activation	6-4
Verizon Activation Test	6-6
Establishing a CDMA Data Connection	6-7
CDMA Settings	6-8
Phone	6-8
Location Settings	6-9
Data Settings	6-9
System Settings	6-12
Version Information	6-14
Services	6-15

Chapter 7: Wireless Applications

Introduction	7-1
Signal Strength Icon	7-2
Turning the WLAN Radio On and Off	7-2
Find WLANs Application	7-3
Profile Editor Wizard	7-5
Profile ID	7-5
Operating Mode	7-5
Ad-Hoc	7-8
Authentication	7-8
Tunneled Authentication	7-9
User Certificate Selection	7-11
Server Certificate Selection	7-11
Credential Cache Options	7-12
Password	7-14
Advanced Identity	7-15
Encryption	7-15
IP Mode	7-17
IP Address Entry	7-18
Transmit Power	7-19
Battery Usage	7-20
Manage Profiles Application	7-21
Wireless Status Application	7-25

Signal Strength Window	7-25
Current Profile Window	7-27
IPv4 Status Window	7-27
Wireless Log Window	7-29
Versions Window	7-29
Wireless Diagnostics Application	7-31
ICMP Ping Window	7-31
Trace Route Window	7-32
Known APs Window	7-32
Options	7-33
Operating Mode Filtering	7-34
Regulatory Options	7-34
Band Selection	7-35
System Options	7-35
Change Password	7-36
Export	7-37
Cold Boot Persistence	7-38
Registry Settings	7-38
Log On/Off Application	7-38
User Already Logged In	7-38
No User Logged In	7-39

Chapter 8: Maintenance and Troubleshooting

Introduction	8-1
Maintaining the EDA	8-1
Troubleshooting	8-2
EDA	8-2
Bluetooth Connection	8-4
Single Slot USB/Serial Cradle	8-6
Four Slot Ethernet Cradle	8-7
Vehicle Cradle	8-7
Four Slot Spare Battery Charger	8-8
Cables	8-8
Magnetic Stripe Reader	8-9
Trigger Handle	8-10

Appendix A: Technical Specifications

Technical Specifications	A-1
MC70 Accessory Specifications	A-4
COM Port Definitions	A-6
Pin-Outs	A-7

Appendix B: Software Configuration

Radio Power Status LED	B-1
------------------------------	-----

Appendix C: Windows Mobile 6.1 Upgrade Procedures

Introduction C-1
Download License Package C-1
Download Upgrade Package C-2
Secure Boot Loader Upgrade Method C-2
 Requirements C-2
 NAND Flash Firmware Update C-2
 Upgrade Package Installation C-3
 Troubleshooting Upgrade Procedures C-4
AirBEAM Upgrade Method C-5
 Requirements C-5
 Update Procedure C-5
 Troubleshooting AirBEAM Upgrade Procedures C-11
UpdateLoader Update Method C-11
 Requirements C-11
 Update Loader Procedure C-11

Glossary

Index

About This Guide

Introduction

This *Integrator Guide* provides information about setting up and configuring MC70 EDAs and accessories.

✓ **NOTE** Screens and windows pictured in this guide are samples and can differ from actual screens.

Documentation Set

The documentation for the MC70 is divided into guides that provide information for specific user needs.

- **Microsoft® Applications User Guide** - describes how to use Microsoft-developed applications.
- **Application Guide** - describes how to use Zebra-developed applications.
- **MC70 User Guide** - describes how to use the MC70 EDA.
- **MC70 Integrator Guide** - describes how to set up MC70 product accessories and how to install software.
- **EMDK Help File** - provides API information for writing applications for the MC70.

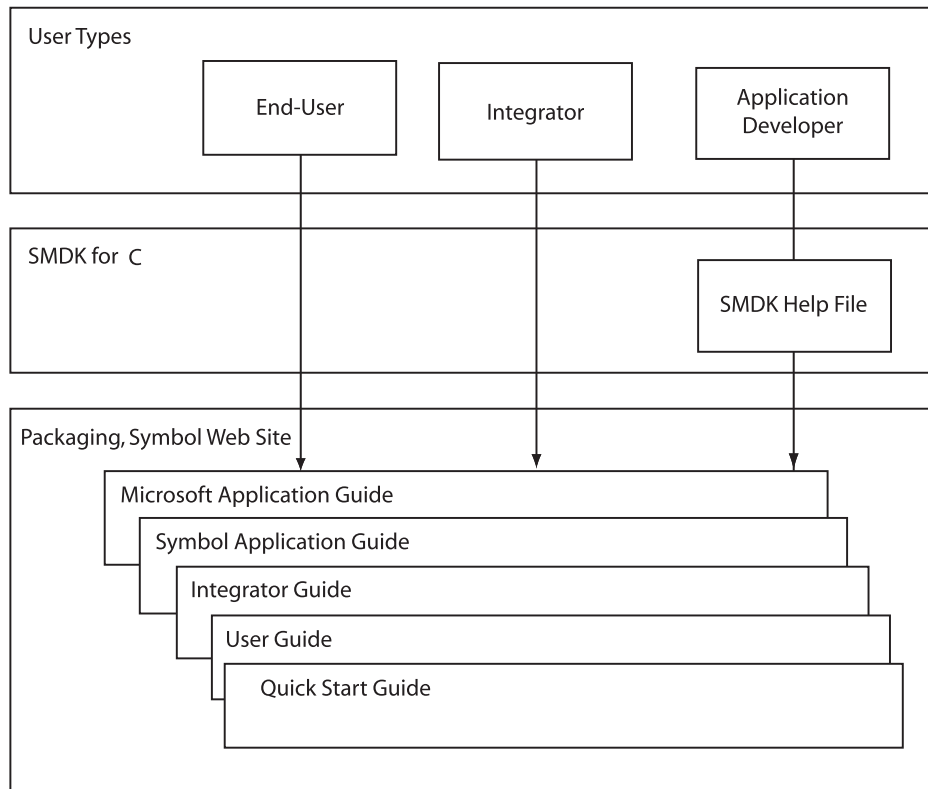

Configurations

This guide covers the following configurations:

Configuration	Radios	Display	Memory	Data Capture	Operating System	Keypads	Other
MC7004	WLAN: 802.11b/g WPAN: Bluetooth WWAN:GPRS	3.5" QVGA Color	64 MB RAM/ 128 MB Flash	1D laser scanner or 2D imager	Windows Mobile 5.0 Professional or Windows Mobile 6.1 Professional	Numeric or QWERTY Keypad	

Configuration	Radios	Display	Memory	Data Capture	Operating System	Keypads	Other
MC7090	WLAN: 802.11b/g WPAN: Bluetooth	3.5" QVGA Color	64 MB RAM/ 128 MB Flash	1D laser scanner or 2D imager	Windows Mobile 5.0 Professional or Winodws Mobile 6.1 Classic	Numeric or QWERTY Keypad	
MC7094	WLAN: 802.11b/g WPAN: Bluetooth WWAN:GPRS	3.5" QVGA Color	64 MB RAM/ 128 MB Flash	1D laser scanner or 2D imager	Windows Mobile 5.0 Professional or Winodws Mobile 6.1 Professional	Numeric or QWERTY Keypad	Haz Loc Class 1 Div 2
MC7095	WLAN: 802.11b/g WPAN: Bluetooth WWAN:EvDO	3.5" QVGA Color	64 MB RAM/ 128 MB Flash	1D laser scanner or 2D imager	Windows Mobile 5.0 Professional or Winodws Mobile 6.1 Professional	Numeric or QWERTY Keypad	

Software Versions

This guide covers various software configurations and references are made to operating system or software versions for:

- Adaptation Kit Update (AKU) version
- OEM version
- Phone version
- BTExplorer version
- Fusion version
- Phone version.

AKU Version

To determine the Adaptation Kit Update (AKU) version:

Tap **Start > Settings > System tab > About icon > Version tab.**

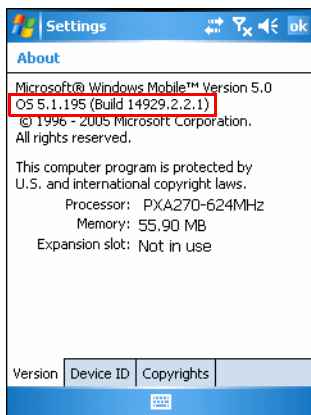

The second line lists the operating system version and the build number. The last part of the build number represents the AKU number. For example, *Build 14929.2.2.1* indicates that the device is running AKU version 2.2.1.

OEM Version

To determine the OEM software version:

Tap **Start > Settings > System tab > System Information icon > System tab**.

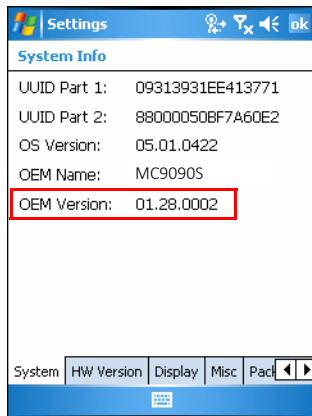

BTE Explorer Software

To determine the BTE Explorer software version:

Tap **BTE Explorer icon > Show BTE Explorer > File > About**.



Fusion Software

To determine the Fusion software version:

Tap **Wireless Strength icon > Wireless Status > Versions**.

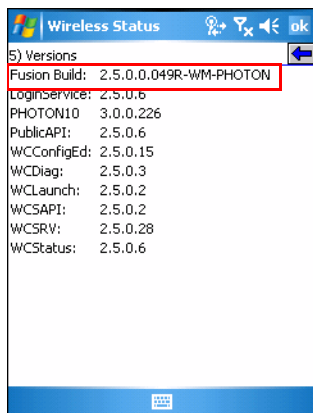

Phone Software

To determine the Phone software version:

Tap **Start > Phone > Menu > Options > Version Information** tab.



MC7094

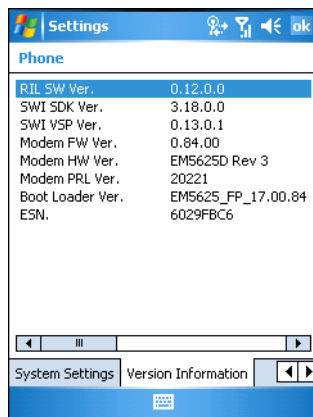

MC7095

Chapter Descriptions

Topics covered in this guide are as follows:

- [Chapter 1, Getting Started](#) provides information on EDA configurations and accessories, charging the battery, and resetting.
- [Chapter 2, Accessories](#) describes the accessories available for the EDA and how to set up power connections and battery charging capabilities, where applicable.
- [Chapter 3, ActiveSync](#) provides instructions on installing ActiveSync and setting up a partnership between the EDA and a host computer.
- [Chapter 4, Application Deployment for Windows Mobile](#) provides information for provisioning and deploying applications to the EDA.
- [Chapter 5, MC7004/94 - GSM Configuration](#) explains how to verify MC7004/94 service on an Enhanced Data rates for Global Evolution (EDGE) wireless network and establish settings.
- [Chapter 6, MC7095 - CDMA Configuration](#) explains how to configure MC7095 service on an CDMA wireless network and establish settings.

- *Chapter 7, Wireless Applications* describes how to configure the wireless LAN connection.
- *Chapter 8, Maintenance and Troubleshooting* includes instructions on cleaning and storing the EDA, and provides troubleshooting solutions for potential problems during EDA operation.
- *Appendix A, Technical Specifications* includes tables listing the technical specifications for the EDA and its accessories.

Notational Conventions

The following conventions are used in this document:

- “EDA” refers to any Zebra terminal.
- *Italics* are used to highlight the following:
 - chapters and sections in this and related documents
 - dialog box, window, and screen names
 - drop-down list and list box names
 - check box and radio button names
 - icons on a screen.
- **Bold** text is used to highlight the following:
 - key names on a keypad
 - button names on a screen.
- Bullets (•) indicate:
 - action items
 - lists of alternatives
 - lists of required steps that are not necessarily sequential.
- Sequential lists (e.g., those that describe step-by-step procedures) appear as numbered lists.

Related Documents and Software

The following documents provide more information about the MC70 EDAs.

- *MC70 Quick Start Guide*, p/n 72-71770-xx
- *MC70 Microsoft Mobile 5.0 Regulatory Information*, p/n 72-71767-xx
- *MC70 User Guide*, p/n 72E-71769-xx
- *Microsoft® Applications for Mobile and CE 5.0 User Guide*, p/n 72E-78456-xx
- *Microsoft Applications for Windows Mobile 6 User Guide*, p/n 108299-xx
- *Application Guide*, p/n 72E-68901-xx
- *Enterprise Mobility Developer Kits (EMDKs)*, available at: <http://www.zebra.com/support>.
- Latest ActiveSync software, available at: <http://www.microsoft.com>.

For the latest version of this guide and all guides, go to: <http://www.zebra.com/support>.

Service Information

If you have a problem with your equipment, contact Zebra support for your region. Contact information is available at: <http://www.zebra.com/support>.

When contacting support, please have the following information available:

- Serial number of the unit
- Model number or product name
- Software type and version number

Zebra responds to calls by email, telephone or fax within the time limits set forth in support agreements.

If your problem cannot be solved by Zebra Support, you may need to return your equipment for servicing and will be given specific directions. Zebra is not responsible for any damages incurred during shipment if the approved shipping container is not used. Shipping the units improperly can possibly void the warranty.

If you purchased your business product from a Zebra business partner, contact that business partner for support.

Chapter 1 Getting Started

Introduction

This chapter provides information about the EDA, accessories, charging the EDA, and resetting the EDA.

Unpacking the EDA

Carefully remove all protective material from the EDA and save the shipping container for later storage and shipping. Verify that you received the following equipment:

- MC70 EDA
- Lithium-ion battery
- Battery cover/strap assembly
- Tethered stylus
- Protective overlay, installed on display window
- Regulatory Guide
- Quick Start Guide.

Depending on the configuration ordered, the EDA package can also include:

- Standard or extra capacity battery
- AC adaptor
- Communication/charging cable
- Power supply
- US line cord
- Headset
- Single Slot USB/Serial Cradle.

Inspect the equipment. If any equipment is missing or damaged, contact Zebra support immediately. See [Service Information on page xix](#) for contact information.

Accessories

Table 1-1 lists the accessories available for the EDA.

Table 1-1 MC70 Accessories

Accessory	Description
Snap-on Cables	The EDA supports the following cables: <ul style="list-style-type: none"> • AC line cord (country-specific) and power supply, charges the EDA. • Auto charge cable, charges the EDA using a vehicle's cigarette lighter. • DEX cable, connects the EDA to a vending machine. • Serial cable, adds serial communication capabilities. • USB cable, adds USB communication capabilities. • Modem inverter cable. • Printer cables, available for O'Neil and Zebra printers from printer vendors.
Single Slot USB/Serial Cradle	Charges the EDA main battery and a spare battery. Synchronizes the EDA with a host computer through either a serial or a USB connection.
Four Slot Ethernet Cradle	Charges the EDA main battery and connects the EDA with an Ethernet network.
VCD7000 Vehicle Cradle	Installs in a vehicle and charges the EDA main battery and a spare battery. Provides serial data communication between an EDA and an external device.
Four Slot Spare Battery Charger	Charges up to four EDA spare batteries (additional adapter required).
Headset	Use in noisy environments.
Belt-Mounted Rigid Holster	Clips onto belt to hold the EDA when not in use.
Magnetic Stripe Reader (MSR)	Snaps on to the EDA and adds magstripe read capabilities.
Memory Card (MMC/SD)	Provides secondary non-volatile storage.
Software	<i>Enterprise Mobility Developer Kits (EMDKs)</i> , available at: http://www.zebra.com/support .
Spare lithium-ion battery	Replacement batteries: 1900 mAh, 3600 mAh, 3800 mAh and 4800 mAh batteries.
Stylus	Performs pen functions.
Trigger Handle	Snap-on attachment adds a gun-style handle to the EDA.
Wall Mounting Kit	Use for wall mounting the cradles.

Getting Started

To start using the EDA for the first time:

- Install the main battery and cover assembly.
- Charge the EDA.
- Power on the EDA.
- Configure the EDA.

Charge the main battery before or after it is installed. Use one of the spare battery chargers to charge the battery (out of the EDA), or one of the cradles to charge the battery installed in the EDA.

Installing and Removing the Main Battery

Installing the Main Battery

Before using the EDA, install a lithium-ion battery. Depending upon the configuration, the MC70 may ship with a 1900 mAh, 3600 mAh or 3800 mAh battery. The 1900 mAh battery is shown. The extended capacity batteries require a larger capacity battery cover. When using the 4800 mAh battery (light gray color), ensure that the 4800 mAh battery door is used.

1. Insert the battery, top first, into the battery compartment in the back of the EDA.
2. Press the battery down into the battery compartment until the battery release latch snaps into place.

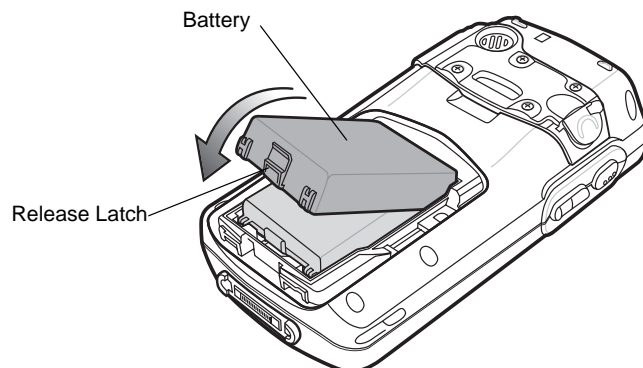

Figure 1-1 *Inserting the Battery*



NOTE Position the battery correctly, with the battery charging contacts on top of the charging contacts in the battery compartment.

3. With the battery cover latches open, insert the cover, bottom first, then press down on the top of the cover.

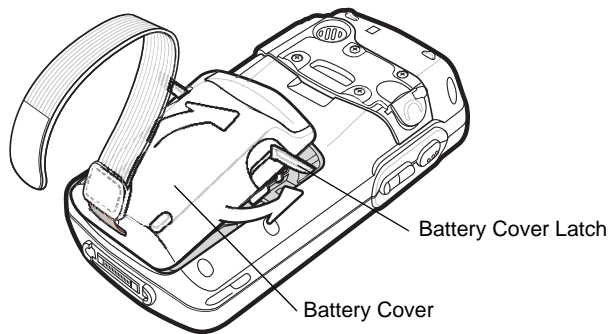

Figure 1-2 *Inserting the Battery Cover*

4. Close the battery cover latches on either side of the battery cover.
5. Insert the handstrap through the handstrap slot, then tighten and press down to secure.

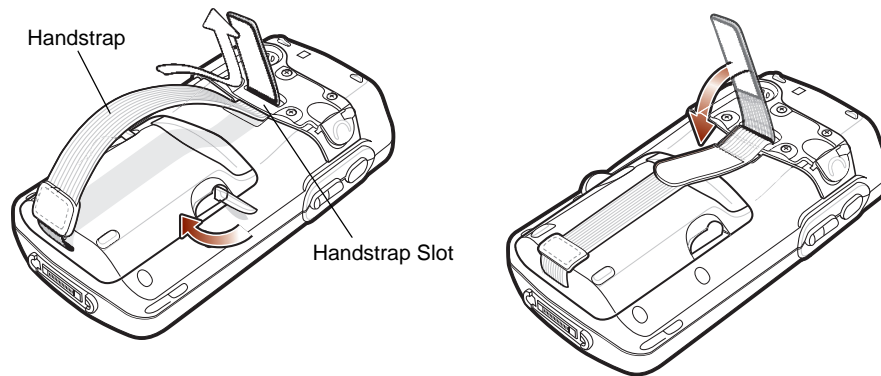

Figure 1-3 *Inserting the Handstrap*

The EDA powers up after inserting the battery.

Removing the Main Battery

1. Press the red **Power** button to suspend the EDA.
2. Loosen the handstrap at the top of the EDA.
3. Open the battery cover latches on either side of the battery cover.

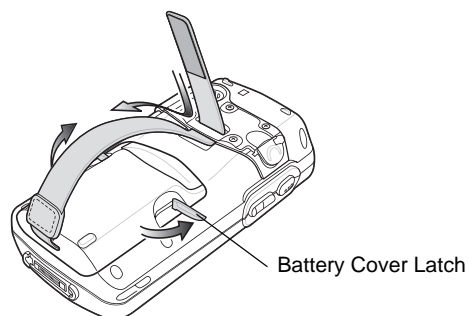

Figure 1-4 *Opening the Battery Cover Latches*

4. Lift the top of the battery cover and remove.

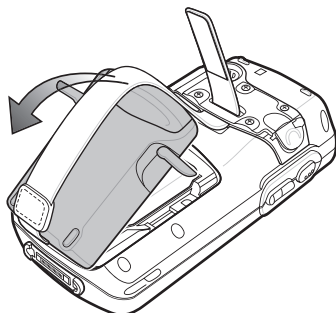

Figure 1-5 *Removing the Battery Cover*

5. Press the battery release latch on the bottom of the battery to unlock, and lift the battery out of the well.

Charging the Battery

Charging the Main Battery and Memory Backup Battery

Before using the EDA for the first time, charge the main battery until the amber Charge Status LED remains lit (see [Table 1-3 on page 1-6](#) for charge status indications) using a cable or a cradle with the appropriate power supply. For information about the accessories available for the EDA, see [Chapter 2, Accessories](#).

The EDA is equipped with a memory backup battery which automatically charges from the fully-charged main battery. When the EDA is used for the first time, the backup battery requires approximately 24 hours to fully charge. This also applies any time the backup battery is discharged, which occurs when the main battery is removed for several hours. The backup battery retains RAM data in memory for at least 30 minutes (at room temperature) when the EDA's main battery is removed. When the EDA reaches a very low battery state, the combination of main battery and backup battery retains data in memory for at least 40 hours.

To charge batteries, use either a cable or one of the following cradles:

- [Single Slot USB/Serial Cradle on page 2-4](#)
- [Four Slot Ethernet Cradle on page 2-6](#)
- [VCD7000 Vehicle Cradle on page 2-12](#).

Snap-on accessories such as the Magnetic Stripe Reader (MSR) and the Trigger Handle provide a pass-through port for charging.

To charge the main battery in the EDA:

1. Connect the charging accessory to the appropriate power source. See [Chapter 2, Accessories](#) for setup information.
2. Insert the EDA into a cradle or attach the cable. The EDA begins charging. The Charge LED is amber while charging, then turns solid amber when fully charged. See [Table 1-3](#) for charging indications.

[Table 1-2](#) list the charge times for each available battery.

Table 1-2 *Battery Charge Times*

Battery Size	Charge Time
1900 mAh	Charges in less than four hours.
3600 mAh	Charges in less than eight hours.
3800 mAh	Charges in less than eight hours.
4800 mAh	Charges in less than ten hours.

Table 1-3 *LED Charge Indicators*

Charging Status LED	Indication
Off	EDA is not charging; EDA is not inserted correctly in the cradle or connected to a power source; charger is not powered.
Slow Blinking Amber (1 blink every 2 seconds)	EDA is charging.
Solid Amber	Charging complete. Note: When the battery is initially inserted in the EDA, the amber LED flashes once if the battery power is low or the battery is not fully inserted.
Fast Blinking Amber (2 blinks/second)	Charging error, e.g.,: <ul style="list-style-type: none"> • Temperature is too low or too high. • Charging has gone on too long without completing (typically eight hours).

Charging Spare Batteries

Use one of the following accessories to charge a spare battery:

- [Single Slot USB/Serial Cradle on page 2-4](#)
- [Four Slot Spare Battery Charger on page 2-20](#)
- [VCD7000 Vehicle Cradle on page 2-12.](#)

To charge a spare battery:

1. Connect the spare battery charging accessory to the appropriate power source.
2. Insert the spare battery into the accessory's spare battery charging slot with the charging contacts facing down (over the charging pins) and gently press down on the battery to ensure proper contact.

The battery begins charging. The amber charge LED on the accessory lights to show the charge status.

[Table 1-2](#) list the charge times for each available battery.

Charging Temperature

Charge batteries in temperatures from 0°C to 40°C (32°F to 104°F). Note that at temperatures above 35°C, charging is intelligently controlled by the EDA and the charging accessory in order to ensure safe operation and optimize long-term battery life.

To accomplish this, for small periods of time, the EDA or accessory alternately enables and disables battery charging to keep the battery at acceptable temperatures. The EDA or accessory indicates when charging is disabled due to abnormal temperatures via its LED. See [Table 1-3](#).

Powering On the EDA

Press the **Power** button to turn on the EDA. If the EDA does not power on, reset it. See [Resetting the EDA on page 1-7](#).

When turning the EDA on for the first time, the splash screen displays for about a minute as the EDA initializes its flash file system, then the calibration window appears. Note that these windows also appear upon cold boot.

✓ **NOTE** When the EDA powers up after inserting a battery for the first time, the device boots and powers on automatically.

Calibrating the Screen

To calibrate the screen so the cursor on the touch screen aligns with the tip of the stylus:

1. Remove the stylus from its holder on the back of the EDA.
2. Carefully press and briefly hold the tip of stylus on the center of each target that appears on the screen.
3. Repeat as the target moves around the screen, then tap the screen to continue.

Resetting the EDA

There are two reset functions, warm boot and cold boot. A warm boot restarts the EDA by closing all running programs. A cold boot also restarts the EDA, and also resets the clock. Data saved in flash memory or a memory card is not lost.

Perform a warm boot first. If the EDA still does not respond, perform a cold boot.

Performing a Warm Boot

Hold down the **Power** button for approximately five seconds. As soon as the EDA starts to perform a warm boot release the **Power** button.

Performing a Cold Boot

To perform a cold boot:

1. Simultaneously press the **Power** button and the 1 and 9 keys.
2. The EDA initializes.

Performing a Clean Boot



CAUTION A clean boot should only be performed by an authorized system administrator. You must connect the EDA to AC power during a clean boot.

Removing AC power from the EDA during a clean boot may render the EDA inoperable.

A clean boot resets the EDA to the factory default settings. All data in the **Application** folder is retained. You must download the Clean Boot Package file from the Support Central and install on the EDA.

To perform a clean boot:

1. Download the Clean Boot Package from the Support Central. Follow the instructions included in the package for installing the package onto the EDA.
2. Simultaneously press the **Power** button and the **1** and **9** keys.
3. Immediately, as soon as the device starts to boot and before the splash screen is visible, press and hold the left scan button.
4. Insert the EDA into a powered cradle.
5. The EDA updates and then re-boots.
6. Calibrate the screen.

Waking the EDA

The wakeup conditions define what actions wake up the EDA. These settings are configurable and the factory default settings shown in <Blue>Table 1-4 are subject to change/update.

Table 1-4 *Wakeup Conditions (Default Settings)*

Status	Description	Conditions for Wakeup
Power Off (Suspend Mode)	When the EDA suspends by pressing Power , these actions wake the EDA.	1. Power button is pressed. 2. AC power added or removed. 3. Cradle/cable connect or disconnect.
		Key or scan button is pressed.
		Real Time Clock set to wake up.
		Incoming phone call (MC7004/94/95 only)
Auto Off	When the EDA suspends by an automatic power-off function, these actions wake the EDA.	1. Power button is pressed. 2. AC power added or removed. 3. Cradle/cable connect or disconnect.
		Key or scan button is pressed.
		Real Time Clock set to wake up.
		Incoming phone call (MC7004/94/95 only)

Locking the EDA

Use the Device Lock feature to prevent use of the device. Note that when locked, the EDA does not respond to screen or keypad input.

To lock the device, tap the **Device unlocked** icon. The icon changes to locked.

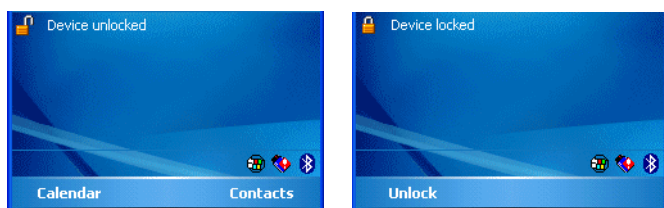

Figure 1-6 Device Locked/Unlocked Icons

To unlock the device and free it for use, tap **Unlock**.



Figure 1-7 Unlock Device Window

Tap **Unlock** on the *Unlock Device* window.

SIM Card

✓ **NOTE** MC7004 and MC7094 only.

GPRS phone service requires a Subscriber Identification Module (SIM) card, or smart card. Obtain this from the phone service provider. The card fits into the EDA and can contain the following information:

- Mobile phone service provider account details.
- Information regarding service access and preferences.
- Contact information, which can be moved to Contacts on the EDA.
- Any additional services to which you have subscribed.

✓ **NOTE** For more information about SIM cards, refer to the mobile phone service provider's documentation.

To install the SIM card:

1. Press the red **Power** button to suspend the EDA.
2. Remove the battery.
3. Lift the SIM cover using the stylus tip.

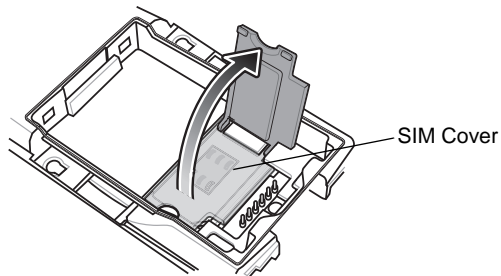

Figure 1-8 *Lifting the SIM Cover*

4. Insert the SIM card, as shown in [Figure 1-9](#), with the cut edge of the card facing out and the contacts facing down.

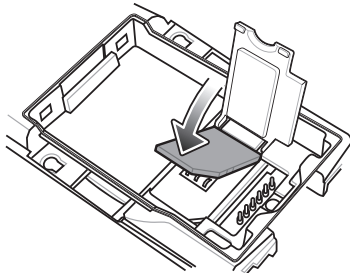

Figure 1-9 *Inserting the SIM Card*

5. Lower the SIM cover and snap it in place.
6. Replace the battery and battery cover.
7. Press the red **Power** button.
8. Tap **Start > Phone > Menu > Options > Network** tab and verify that the service provider appears in the **Current network:** field.
9. Make a call to verify connection.

✓ **NOTE** For detailed information about WWAN activation and settings, see [Chapter 5, MC7004/94 - GSM Configuration](#).

Removing the Screen Protector

A screen protector is applied to the EDA. Zebra recommends using this to minimize wear and tear. Screen protectors enhance the usability and durability of touch screen displays.

To remove the screen protector, lift the corner using a thin plastic card, such as a credit card, then carefully lift it off the display.

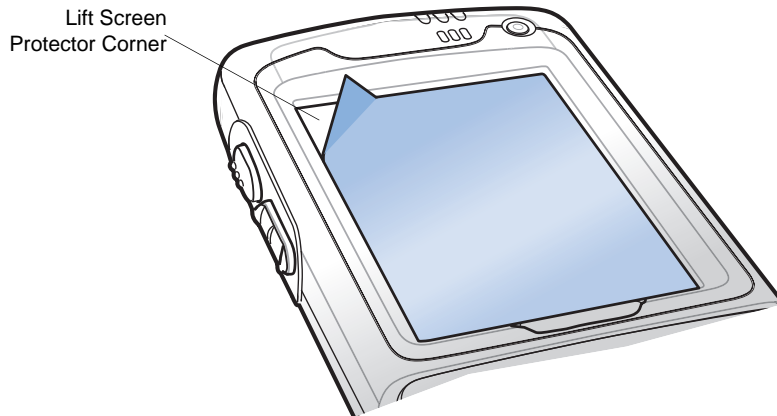

Figure 1-10 *Removing the Screen Protector*



CAUTION Do not use a sharp object to remove the protector. Doing so can damage the display.



NOTE Not using a screen protector can affect warranty coverage. To purchase replacement protectors, contact your local account manager or Zebra. These include screen protector installation instructions. Part number: KT-67525-01 Screen Protector 3/pk.

Chapter 2 Accessories

Introduction

MC70 accessories provide a variety of product support capabilities. Accessories include cables, cradles, four-slot spare battery charger, headset, Multimedia Card (MMC), Secure Device (SD) card, Magnetic Stripe Reader (MSR), and trigger handle.

Cables

Snap one of the following cables on to the EDA to connect an external device.

- USB Client charge cable
- RS232 charge cable
- DEX cable
- Modem inverter cable
- Autocharge cable.

Cradles

- Single Slot USB/Serial cradle charges the EDA main battery and a spare battery. It also synchronizes the EDA with a host computer through a USB connection.
- Four Slot Ethernet cradle charges the EDA main battery and connects the EDA with an Ethernet network.
- Vehicle cradle charges the EDA main battery and a spare battery.

Miscellaneous

- Four Slot Spare Battery Charger charges up to four EDA spare batteries.
- Headset can be used in noisy environments.
- Multimedia Card or Secure Digital (SD) Card provides secondary non-volatile storage.
- Belt Mounted Rigid Holster holds the EDA when not in use.

Snap-on Modules

- MSR snaps on to the EDA and adds magstripe read capabilities.
- TRG7000 Trigger Handle adds a gun-style handle with a scanning trigger to the EDA.

Headset

Use the headset to communicate via Voice-over-IP (VoIP) or for audio playback. To connect the headset, remove the plug from the headset jack at the top of the EDA and insert the headset connector. Contact a Zebra representative for compatible headsets.

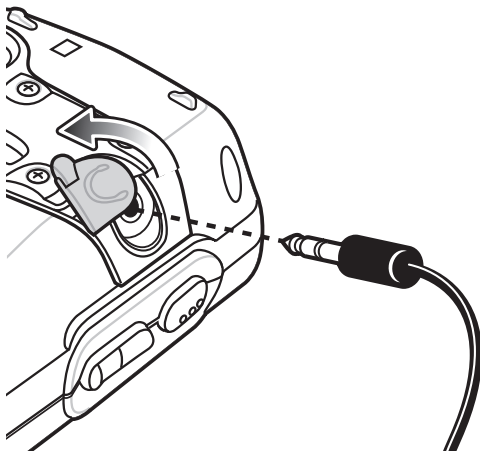

Figure 2-1 Headset Connection

Multi Media Card (MMC) / Secure Digital (SD) Card

The MMC/SD card slot provides secondary non-volatile storage. The slot is located on the side of the EDA (see [Figure 2-2](#)). Refer to the documentation provided with the card for more information, and follow the manufacturer's recommendations for use. The slot also accepts SDIO cards.



NOTE SD cards are interoperable with MMC cards; both can be used in MC70 EDAs.

MC70 mobile computers with OEM Version 04.39.0000 support SD Memory Cards up to 2 GB.



CAUTION Follow proper ESD precautions to avoid damaging the MMC/SD. Proper ESD precautions include, but are not limited to, working on an ESD mat and ensuring that the operator is properly grounded.

To insert the MMC/SD card:

1. Power off the EDA.
2. Remove the card cover on the side of the EDA by loosening the screws and lifting the cover out of the slot.

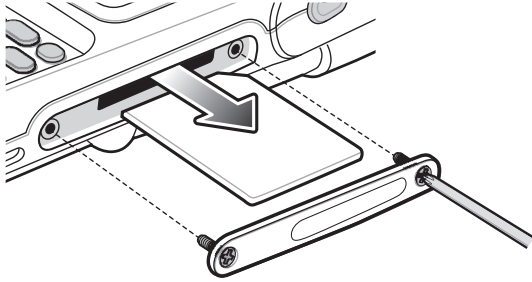

Figure 2-2 Card Cover Removal

3. Insert the card with the card contacts facing down and the cut corner on the right, until you feel a click.
4. Replace the housing cover and secure with the screws.

To remove an MMC/SD card:

1. Power off the EDA.
2. Remove the card cover at the top of the EDA by loosening the screws and lifting the cover out of the slot.
3. Using the stylus, press and release the card to eject it.
4. Remove the card from the card slot.
5. Replace the card cover.

SD/SDIO Setup

✓ **NOTE** On devices with AKU 3.2 and higher, the **SDSwitch Settings** application is installed.

Use the **SDSwitch Settings** application to indicate the type of card installed in the SD slot.

1. Tap **Start > Settings > System tab > SDSwitch** icon.

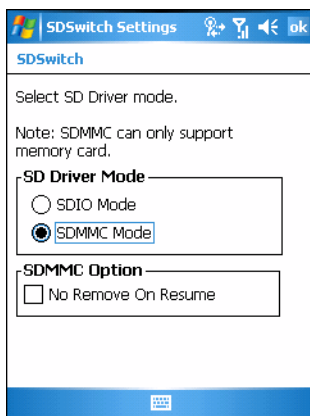

Figure 2-3 SDSwitch Settings Window

2. In the **SD Driver Mode** section, select the type of SD card installed in the SD slot.
 - Tap the **SDIO Mode** radio button if an SDIO card is installed in the SD slot.
 - Tap **SDMMC Mode** radio button if an SD or MMC card is installed in the SD slot.

3. Tap **ok**.
4. A dialog box displays indicating that the EDA must be reset for the change to take effect. Tap **ok**.
5. Perform a warm boot.

Single Slot USB/Serial Cradle

This section describes how to set up and use a Single Slot USB/Serial cradle with the EDA. For USB communication setup procedures see [Chapter 3, ActiveSync](#).

The Single Slot USB/Serial Cradle:

- Provides 5.4 VDC power for operating the EDA.
- Synchronizes information between the EDA and a host computer. See [Chapter 3, ActiveSync](#) for information on setting up a partnership between the EDA and a host computer.
- Charges the EDA's battery.
- Charges a spare battery.

✓ **NOTE** Use only an approved power supply output rated 12 Vdc and minimum 3.33A. The power supply is certified to EN60950 with SELV outputs. Use of an alternative power supply will invalidate any approval given to this device and may be dangerous.

HINWEIS

Setup

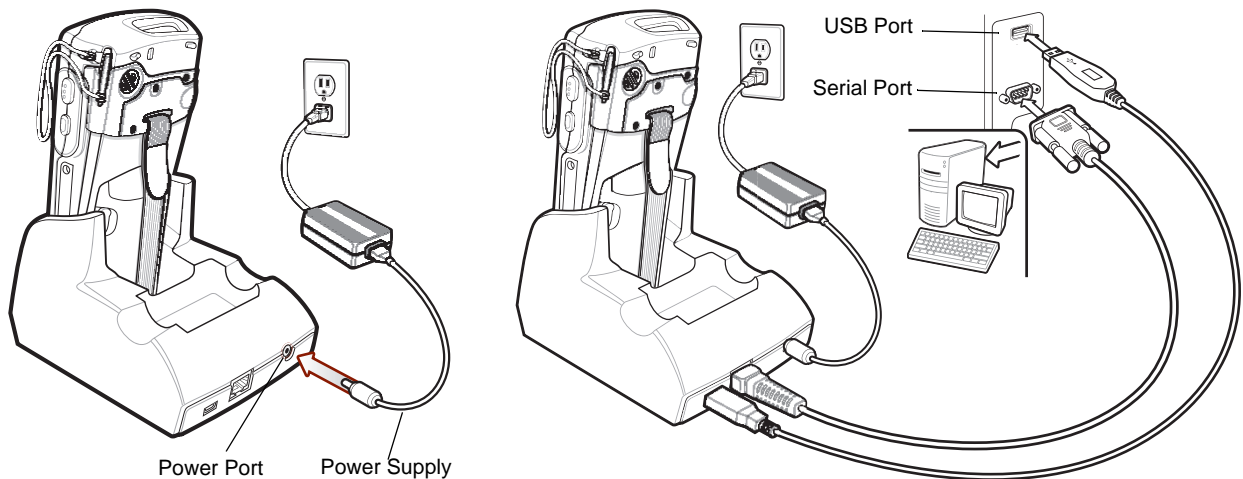

Figure 2-4 Single Slot USB/Serial Cradle Power and USB Connections

Charging the EDA Battery

Connect the cradle to power. Insert the EDA into the EDA slot to begin charging.

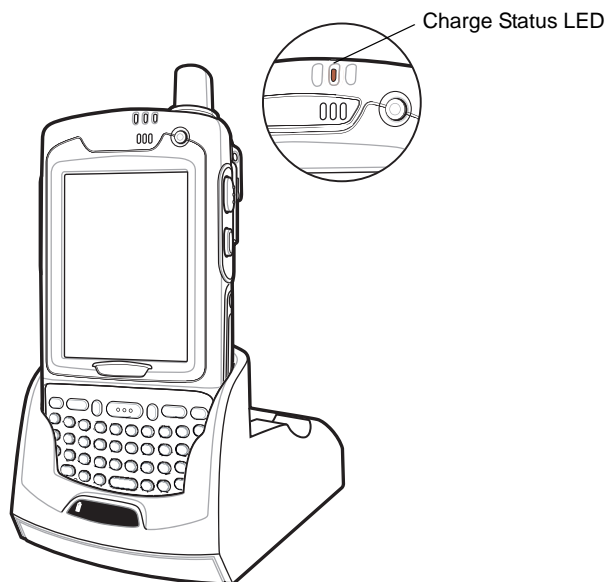

Figure 2-5 EDA Battery Charging

Charging the Spare Battery

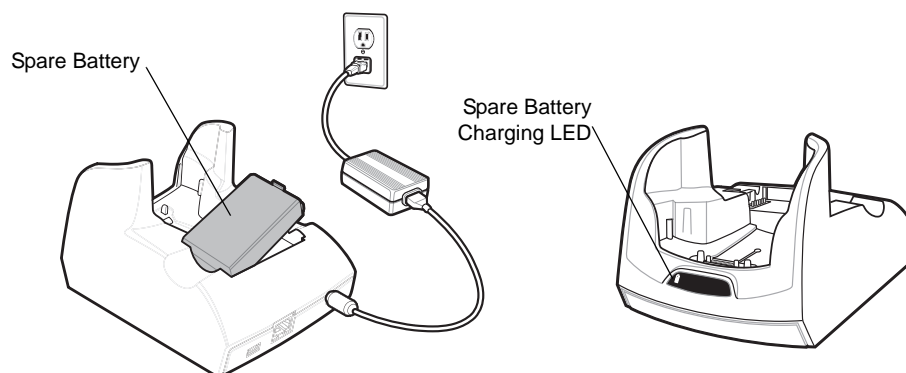

Figure 2-6 Spare Battery Charging

Battery Charging Indicators

The Single Slot USB/Serial Cradle charges the EDA's main battery and a spare battery simultaneously.

The EDA's Charge LED indicates the status of the battery charging in the EDA. See [Table 1-3 on page 1-6](#) for charging status indications.

The spare battery charging LED on the cradle indicates the status of the spare battery charging in the cradle. See [Table 2-1](#) for charging status indications.

See [Table 1-2 on page 1-6](#) for the amount of time required for battery charging.

Charging Temperature

Charge batteries in temperatures from 0°C to 40°C (32°F to 104°F). Note that at temperatures above 35°C, charging is intelligently controlled by the EDA and the charging accessory in order to ensure safe operation and optimize long-term battery life.

To accomplish this, for small periods of time, the EDA or accessory alternately enables and disables battery charging to keep the battery at acceptable temperatures. The EDA or accessory indicates when charging is disabled due to abnormal temperatures via its LED. See [Table 1-3 on page 1-6](#) and [Table 2-1](#).

Table 2-1 Spare Battery LED Charging Indicators

Spare Battery LED (on cradle)	Indication
Slow Blinking Amber	Spare battery is charging.
Solid Amber	Spare battery is fully charged.
Fast Blinking Amber	Charging error.
Off	Not charging.

Four Slot Ethernet Cradle

This section describes how to set up and use a Four Slot Ethernet cradle with the EDA.

The Four Slot Ethernet cradle:

- Provides 5.4 VDC power for operating the EDA.
- Connects the EDA (up to four) to an Ethernet network.
- Simultaneously charges up to four EDAs.

You cannot ActiveSync using the Four Slot Ethernet cradle. To ActiveSync with a host computer, use the Single Slot USB/Serial cradle.

- ✓ **NOTE** Use only an approved power supply output rated 12 Vdc and minimum 9A. The power supply is certified to EN60950 with SELV outputs. Use of an alternative power supply will invalidate any approval given to this device and may be dangerous.

HINWEIS

Setup

Connect the Ethernet cradle to a power source and to an Ethernet switch, router, or hub, or a port on the host device.

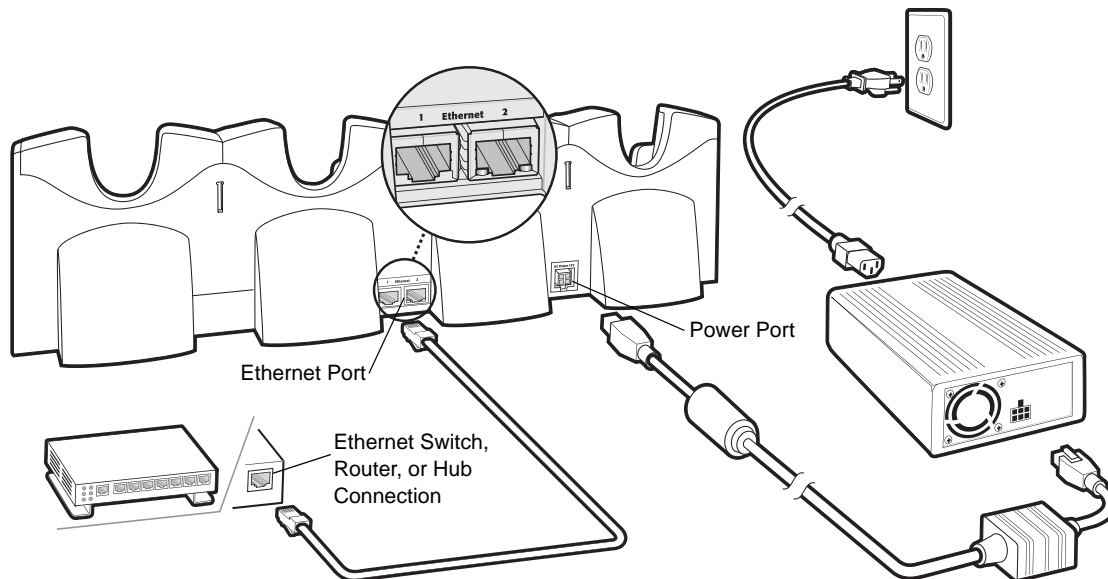

Figure 2-7 Four Slot Ethernet Cradle Connection

Daisychaining Cradles

Daisychain up to four Ethernet cradles to connect several cradles to an Ethernet network. Use either a straight or crossover cable.

To daisychain more than one cradle:

1. Connect power to each cradle to daisychain.
2. Connect an Ethernet cable to Port 1 of the first cradle as shown in [Figure 2-7](#).
3. Connect a second Ethernet cable between Port 2 of the first cradle, and Port 1 of the second.
4. Connect up to two more cradles as described in Step 3.

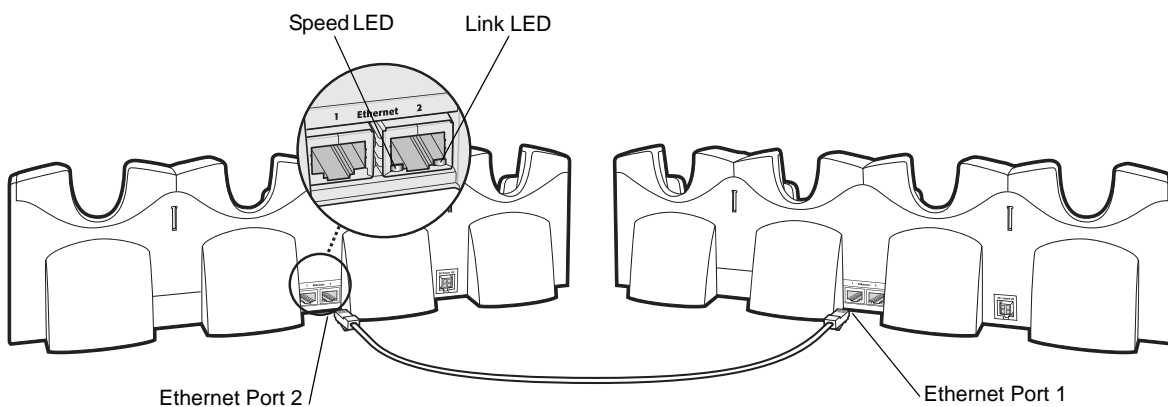

Figure 2-8 Daisychaining Four Slot Ethernet Cradles

Bandwidth Considerations when Daisychaining

Each cradle added to the daisychain impacts the bandwidth provided to the inserted EDAs, particularly when the EDAs attempt to send and receive at data rates that exceed the bandwidth provided to the chain (typically 100

Mbps). If an EDA in a daisy-chained cradle does not use its bandwidth, that bandwidth is allocated to other inserted EDAs.

Table 2-2 shows available bandwidth, based on 100 Mbps, for the maximum number of daisy-chained cradles, with each attempting transmission at the maximum data rate.

Table 2-2 *Daisy-chaining Bandwidth*

Daisy-chained Cradles	Bandwidth Provided to Cradle (Bits/sec)	Inserted EDA's Share of Bandwidth
Cradle 1	100,000,000	20,000,000
Cradle 2	20,000,000	4,000,000
Cradle 3	4,000,000	800,000
Cradle 4	800,000	160,000
Cradle 5	160,000	32,000
Cradle 6	32,000	6,400
Cradle 7	6,400	1,280

Ethernet Cradle Drivers

The MC70 includes Ethernet cradle drivers that initiate automatically when you place the EDA in a properly connected Four Slot Ethernet cradle. After inserting the EDA, configure the Ethernet connection:

1. Tap **Start > Settings > Connections** tab > **Network Cards** icon. The **Configure Network Adapters** window appears.

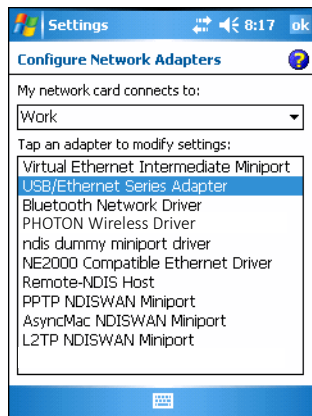

Figure 2-9 *Configure Network Adapters Window*

2. In the **My network card connects to:** drop-down list, select the appropriate connection.
3. In the **Tap an adapter to modify settings:** list, select **USB/Ethernet Series Adapter**.

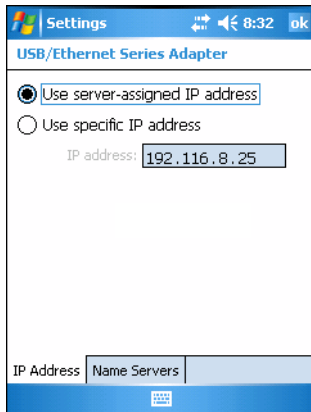

Figure 2-10 *IP Address Tab*

4. In the **IP address** window, select the appropriate radio button:
 - **Use server-assigned IP address**
 - or
 - **Use specific IP address.** Enter the IP address, Subnet mask, and Default gateway, as needed.
5. Tap the **Name Servers** tab.

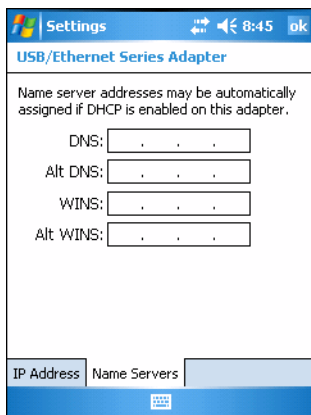

Figure 2-11 *Name Servers Tab*

6. Enter the appropriate DNS, Alt DNS, WINS, and Alt WINS server addresses.
7. Tap **ok**.

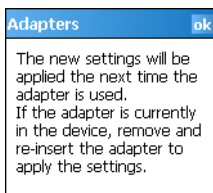

Figure 2-12 *Adapters Dialog Box*

8. Tap **ok** to confirm the setup.
9. Tap **ok** to exit.

Charging and Communication

Insert the EDA into a slot to begin charging.

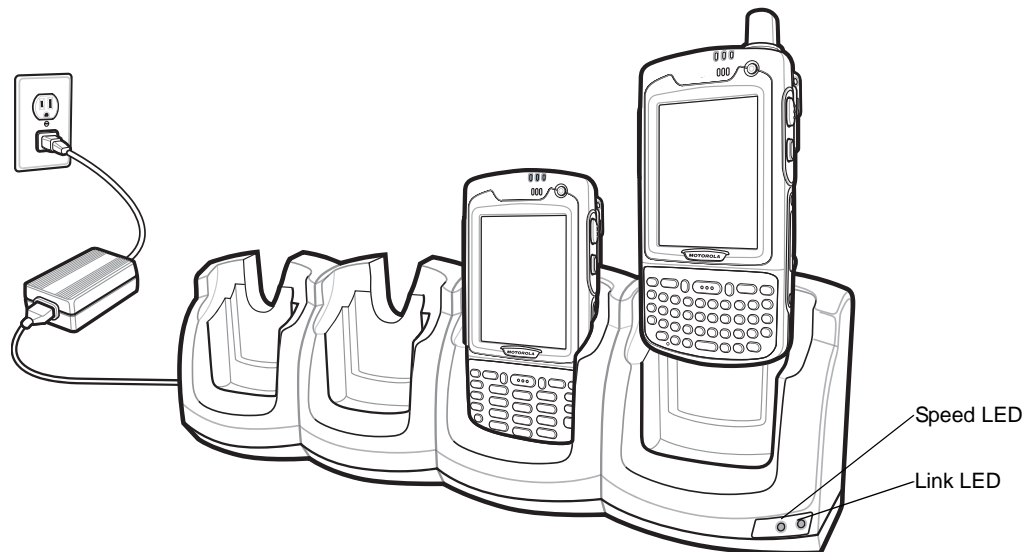

Figure 2-13 EDA Battery Charging

LED Charging Indicators

Charge LED

The EDA's charge LED shows the status of the battery charging in the EDA. See [Table 1-3 on page 1-6](#) for charging status indications.

The standard battery fully charges in approximately four hours and the extended capacity battery fully charges in approximately eight hours.

Speed LED

The cradle's green Speed LED lights to indicate that the transfer rate is 100 Mbps. When it is not lit it indicates that the transfer rate is 10Mbps.

Link LED

The cradle's yellow Link LED blinks to indicate activity, or stays lit to indicate that a link is established. When it is not lit it indicates there is no link.

Charging Temperature

Charge batteries in temperatures from 0°C to 40°C (32°F to 104°F). Note that at temperatures above 35°C, charging is intelligently controlled by the EDA and the charging accessory in order to ensure safe operation and optimize long-term battery life.

To accomplish this, for small periods of time, the EDA or accessory alternately enables and disables battery charging to keep the battery at acceptable temperatures. The EDA or accessory indicates when charging is disabled due to abnormal temperatures via its LED. See [Table 1-3 on page 1-6](#).

Wall Mount Bracket

Use the optional Wall Mount Bracket to mount a four slot cradle to a wall. To attach the Wall Mount Bracket:

1. Use the Wall Mount Bracket as a template and mark the locations of the four mounting screws.

✓ **NOTE** Use fasteners appropriate for the type of wall and the Wall Mount Bracket mounting slots. The Wall Mount Bracket mounting slots are designed for a fastener with a #8 pan head.

2. Mount the fasteners to the wall. The screw heads should protrude about a half of an inch from the wall.
3. Slip the Wall Mount Bracket over the screw heads and slide the bracket down over the screw heads.
4. Tighten the screws to secure the bracket to the wall.

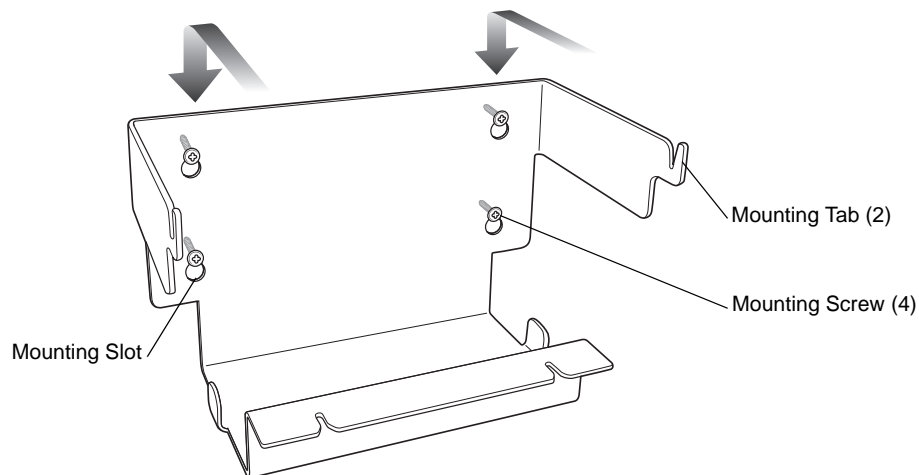

Figure 2-14 Wall Mount Bracket

To mount a four slot cradle:

1. Screw the supplied fasteners into the bottom of the four slot cradle. The screw heads should protrude about a quarter of an inch from the cradle.

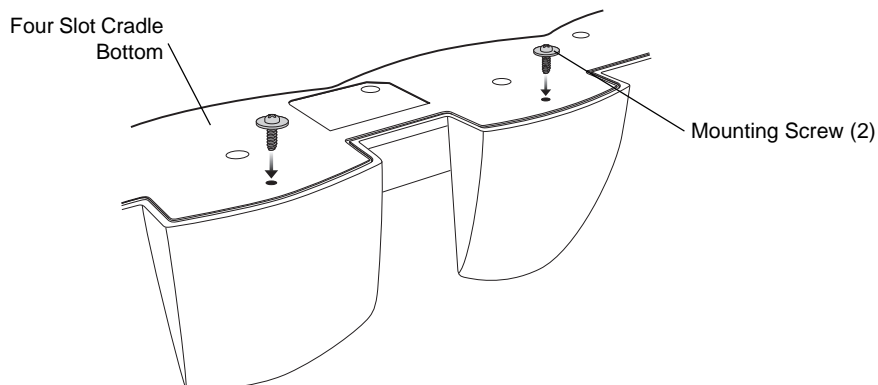

Figure 2-15 Cradle Mounting Screws

2. Align the Wall Mount Bracket mounting tabs with the mounting slots in the back of the four slot cradle. Slip the two mounting tabs into mounting slots.

3. Swing the four slot cradle down onto the mounting bracket and align the mounting screws so that they fit into the screw slots.

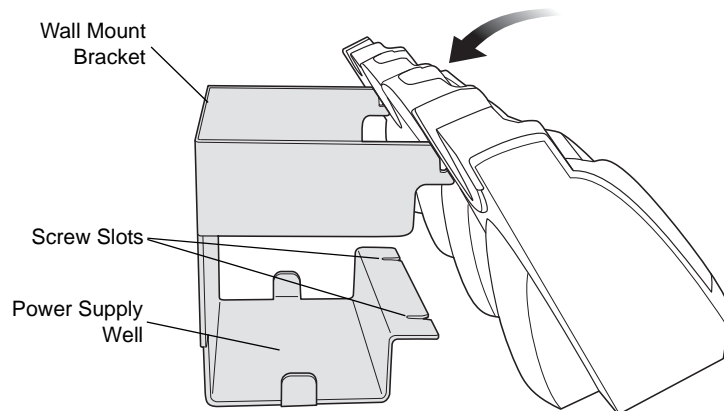

Figure 2-16 Wall Mount Bracket

4. Tighten the mounting screws to secure the four slot cradle to the bracket.

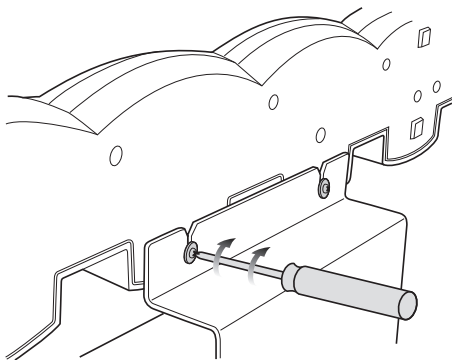

Figure 2-17 Mounting Screws

5. Connect power (see [Figure 2-7 on page 2-7](#)). The power supply should be located in the power supply well.

VCD7000 Vehicle Cradle

This section describes how to use a VCD7000 vehicle cradle with the EDA. For cradle installation and communication setup procedures refer to the *MC70 Integrator Guide*.

Once installed in a vehicle, the cradle:

- holds the EDA securely in place
- provides power for operating the EDA
- provides a serial port for data communication between an EDA and an external device (e.g., a printer)
- re-charges the battery in the EDA
- re-charges a standard capacity or extended capacity spare battery.

Requirements

For mounting:

- four #8-32 self-locking nuts
- four #8 washers
- a drill with a #6 drill bit (.204").

For power connection:

- power input cable (included), p/n 25-61987-01R
- UL Listed in-line fuse rated 250V, 5A (included), must be used if not connecting to vehicle's fuse panel
- in-line fuse holder (included), must be used if not connecting to vehicle's fuse panel.

For serial connection:

- DB9 female serial cable (some devices may require null modem).

For communication:

- an MC70
- host computer setup and EDA setup (as determined by the application you are using).

Connector Ports

There are two connection ports on the bottom of the vehicle cradle:

Table 2-3 *Vehicle Cradle Connection Ports*

Ports	Function
Serial	Standard RS 232 port used for direct connection to the serial device using a serial cable.
Power	Used for connecting to vehicle power using the power input cable.

Connector Pin-Outs

Table 2-4 Power Input Cable

Pin	Signal
1	Chassis ground (Bare Wire)
2	Chassis ground (Bare Wire)
3	V+ (Red Wire)
4	V+ (Red Wire)

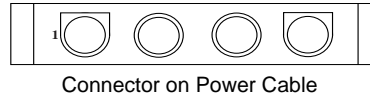
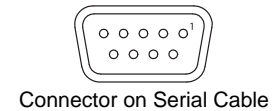

Table 2-5 Serial Cable

Pin	Signal	Pin	Signal
1	DCD	5	GND
2	RxD	6	DSR
3	TxD	7	RTS
4	DTR	8	CTS
5	GND	9	5V_OUT



CAUTION ROAD SAFETY - Do not use the EDA while driving. Park the vehicle first. Always ensure the EDA is fully inserted into the cradle. Do not place it on the seat or where it can break loose in a collision or sudden stop. Lack of proper insertion may result in property damage or personal injury. Zebra is not responsible for any loss resulting from the use of the products while driving. Remember: Safety comes first.

Mounting the Cradle



CAUTION Only mount the Vehicle Cradle in a vertical position with the release level at the top or in a horizontal position with the EDA display facing up. Never mount the vehicle cradle on the side or upside down or on a wall that can be subject to impact or collision of greater than 40Gs, in accordance with SAE J1455 Section 4.10.3.5

1. Select a mounting location for the cradle. It should be flat, and must provide adequate support for the cradle.
2. Prepare the mounting surface to accept four #8-32 studs, using the mounting template below. Drill four holes with a #6 drill bit.

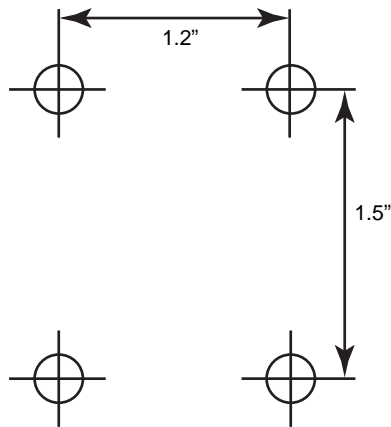

Figure 2-18 Vehicle Cradle Mounting Template

3. Position the cradle on the mounting surface.
4. Fasten it using four #8 washers and four #8-32 self-locking nuts.



CAUTION Do not install a VCD7000 Vehicle Cradle on or near an air bag cover plate or within an aerobic zone. Also, do not install it in a location that affects vehicle safety or driveability.

Power Connection

Please read all of the following instructions before beginning.



WARNING! A properly trained technician must perform the power connection. Improper connection can damage your vehicle, cradle or EDA. Refer to the vehicle's Owner's Manual for instructions for removing power.

To connect the cradle to power:



CAUTION When setting up connection for this cradle, only use the power input cable provided with this cradle.

1. Locate the vehicle power source.



NOTE The ideal location for connecting the vehicle cradle power input cable would be an accessory output in your vehicle's fuse panel. The vehicle cradle should be added to a circuit with a maximum load capacity for the cradle and the original circuit. Refer to the vehicle's *Owner's Manual* for identification of the circuit. If a fused output is not available, the vehicle cradle must be installed with the provided in-line fuse holder and UL Listed 5A fuse. The fuse protects the vehicle from an electrical short on the power line to the cradle. To use the cradle to charge the EDA and spare battery, when the vehicle's ignition is off, connect the cradle to unswitched power.

2. Route the power input cable from the cradle's power port to the connection point for the vehicle's power source.



CAUTION The means of routing and securing the power input cable from the cradle through to the vehicle power source is extremely important. Hazards associated with improper wiring can be severe. To avoid unintentional contact between the wire and any sharp edges, provide the cable with proper bushings and clamping where it passes through openings. If the wire is subjected to sharp surfaces and excess engine vibration, the wiring harness insulation can wear away, causing a short between the bare wire and chassis. This can start a fire. To avoid any mishaps, all wiring should be routed away from moving parts, high temperature areas and any contaminants.

3. When using the supplied in-line fuse holder (which must be used if not connecting to vehicle's fuse panel):
 - a. Ensure the fuse holder contains a 5A UL Listed slow-blow fuse.
 - b. Splice the fuse holder to the end of the red V+ wire, as shown above. Make the distance from the fuse to the power connection point as short as possible.

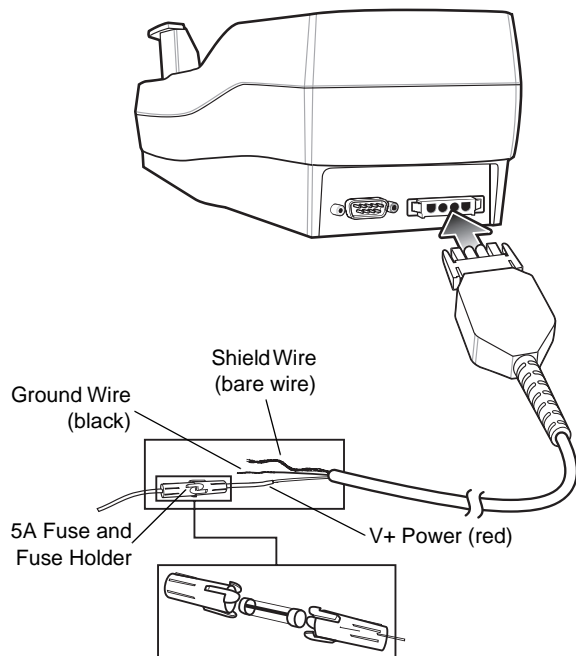

Figure 2-19 Vehicle Cradle Power Connection

4. Prepare the cable termination.
 - a. Red wire: connect to a +12/24 V vehicle power source.
 - b. Black wire and Shield wire: connect to vehicle ground wire or chassis ground.



NOTE How the cable terminates depends on the vehicle. If the vehicle has a power output connector, then you must attach a mating connector to the end of the power cable. You may be able to connect to a fuse panel with a simple blade terminal or commercially available connector. Consult the vehicle *Owner's Manual* for information on how to access the power supply in the vehicle.

5. Connect the power input cable into the power port on the cradle.

To see if the cradle has power, insert the EDA. The Charging LED on the EDA blinks slowly to indicate charging and turns solid amber when the battery is completely charged. See [Table 1-3 on page 1-6](#) for other indications.

Serial Device Connection

The EDA has a serial port on the bottom. When the EDA is inserted into the cradle, it connects to the cradle's serial port. The EDA can then use the cradle's serial port to communicate with an external device.

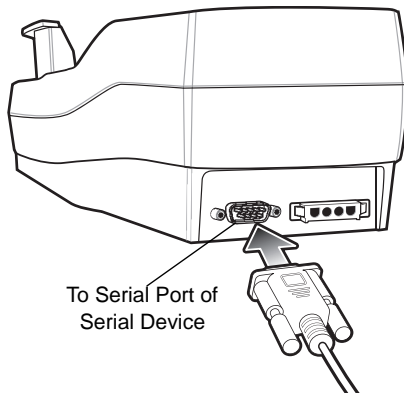

Figure 2-20 Vehicle Cradle Serial Connection

To provide serial communications between an EDA and a serial device, connect one end of the 9-pin serial cable into the serial port on the cradle, and the other end into the serial port on the serial device.

✓ **NOTE** Some devices may require a null modem serial cable.

To begin communication:

1. Insert the EDA into the cradle.
2. To initiate communication, make appropriate selections on the EDA, as determined by the application you are using.



CAUTION Removing the EDA during data communication disrupts communication between the EDA and the attached device.

Charging the EDA Battery

Insert the EDA into the vehicle cradle to begin charging. A click indicates that the EDA button release locking mechanism is enabled and the EDA is locked in place.

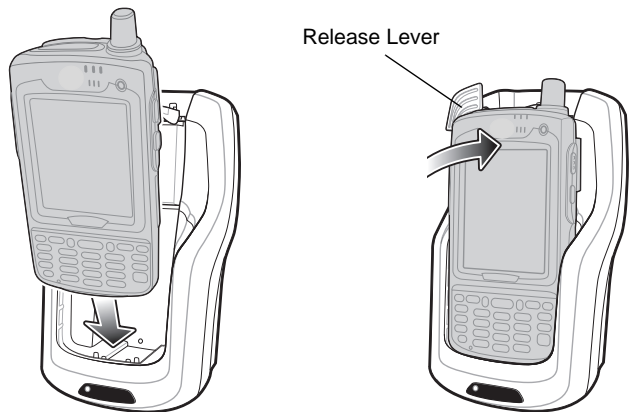



Figure 2-21 EDA Battery Charging

 **CAUTION** Ensure the EDA is fully inserted in the cradle. Lack of proper insertion may result in property damage or personal injury. Zebra is not responsible for any loss resulting from the use of the products while driving.

Removing the EDA

To remove the EDA, hold back the release lever on the cradle and pull the EDA up and out of the cradle.

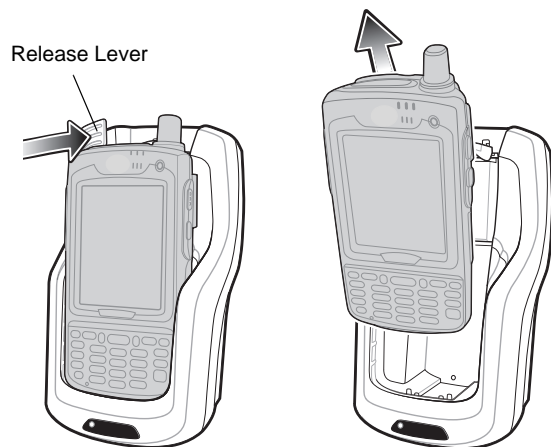

Figure 2-22 Removing the EDA

Charging the Spare Battery

Insert a spare battery to begin charging:

1. Lift the battery release lever.

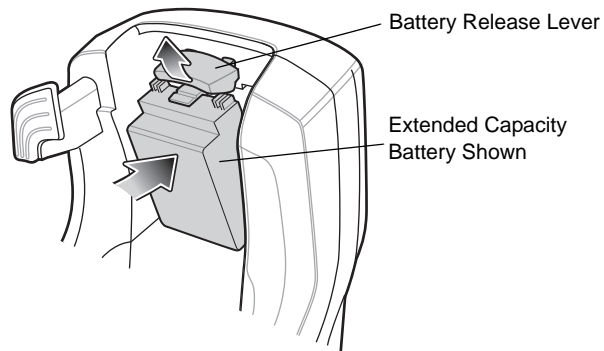

Figure 2-23 *Inserting the Spare Battery*

2. Insert the spare battery in the spare battery charging slot in the cradle with the charging contacts facing up and to the rear of the cradle.
3. Release the battery release lever. The battery release lever locks the spare battery into place.

To remove a spare battery, hold back the battery release lever and lift the battery from the spare battery slot.

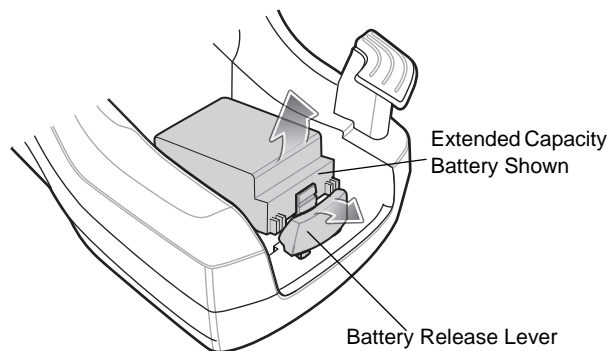

Figure 2-24 *Removing the Spare Battery*

Battery Charging Indicators

The Vehicle Cradle charges the EDA's main battery and a spare battery simultaneously.

The EDA's charge LED indicates the status of the battery charging in the EDA. See [Table 1-3 on page 1-6](#) for charging status indications.

The spare battery charging LED on the cradle indicates the status of the spare battery charging in the cradle. See [Table 2-6](#) for charging status indications.

See [Table 1-2 on page 1-6](#) for the amount of time required for battery charging.

Table 2-6 Vehicle Cradle Spare Battery LED Charging Indicators

Spare Battery LED (on cradle)	Indication
Slow Blinking Amber	Spare battery is charging.
Solid Amber	Spare battery is fully charged.
Fast Blinking Amber	Charging error.
Off	Not charging.

Charging Temperature

Charge batteries in temperatures from 0°C to 40°C (32°F to 104°F). Note that at temperatures above 35°C, charging is intelligently controlled by the EDA and the charging accessory in order to ensure safe operation and optimize long-term battery life.

To accomplish this, for small periods of time, the EDA or accessory alternately enables and disables battery charging to keep the battery at acceptable temperatures. The EDA or accessory indicates when charging is disabled due to abnormal temperatures via its LED. See [Table 1-3 on page 1-6](#) and [Table 2-6](#).

Four Slot Spare Battery Charger

This section describes how to use the Four Slot Spare Battery Charger to charge up to four EDA spare batteries.

- ✓ **NOTE** Use only an approved power supply output rated 12 Vdc and minimum 3.33A. The power supply is certified to EN60950 with SELV outputs. Use of an alternative power supply will invalidate any approval given to this device and may be dangerous.

HINWEIS

Battery Shim Installation

Before charging a spare battery, snap the EDA shim into the battery slot as shown in [Figure 2-25](#).

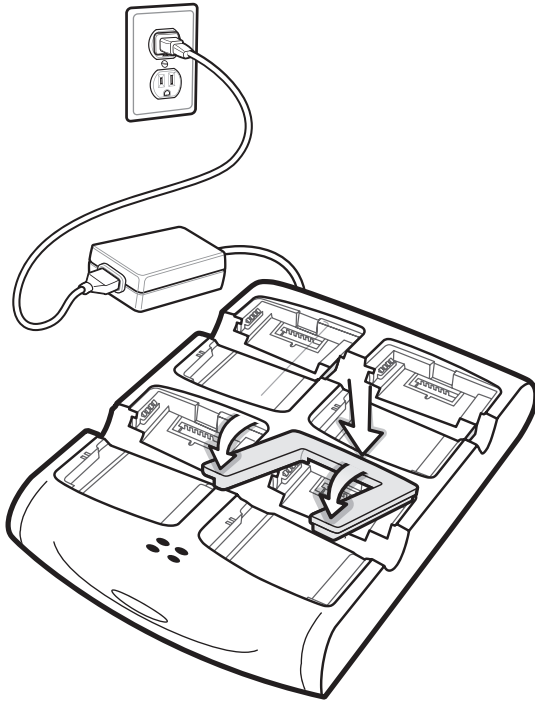

Figure 2-25 Spare Battery Shim Installation

✓ **NOTE** To purchase additional shims, contact your local account manager or Zebra. Part number: KT-76490-01.

Spare Battery Charging

1. Connect the charger to a power source.
2. Insert the spare battery into a spare battery charging well and gently press down on the battery to ensure proper contact.

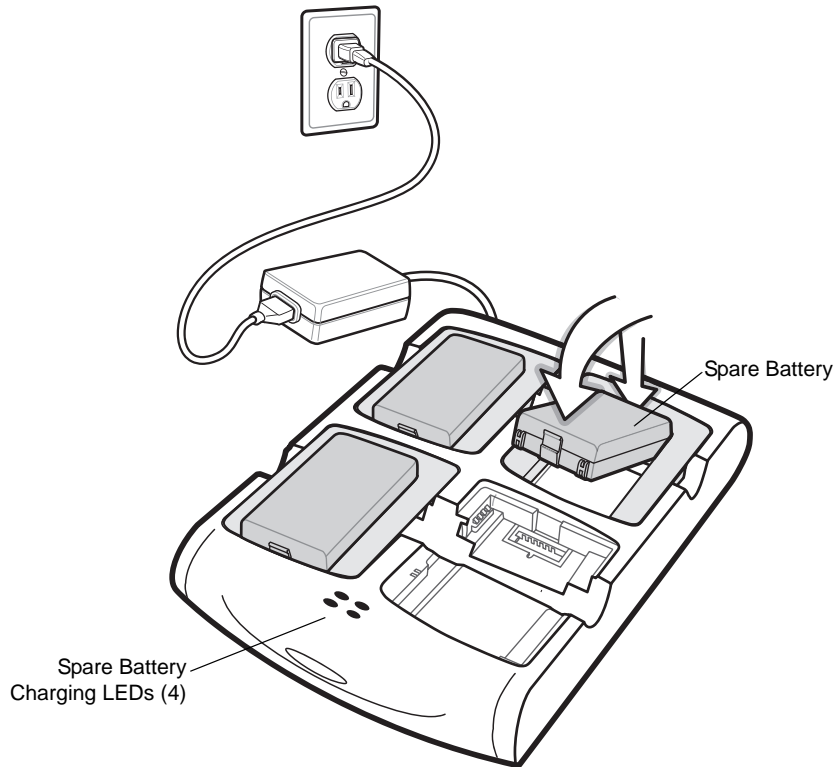

Figure 2-26 Four Slot Spare Battery Charger

Battery Charging Indicators

An amber LED is provided for each battery charging well. See [Table 2-7](#) for charging status indications. See [Table 1-2 on page 1-6](#) for the amount of time required for battery charging.

Charging Temperature

Charge batteries in temperatures from 0°C to 40°C (32°F to 104°F). Note that at temperatures above 35°C, charging is intelligently controlled by the charger in order to ensure safe operation and optimize long-term battery life.

To accomplish this, for small periods of time, the charger alternately enables and disables battery charging to keep the battery at acceptable temperatures. The charger indicates when charging is disabled due to abnormal temperatures via its LED. See [Table 2-7](#).

Table 2-7 Spare Battery LED Charging Indicators

LED	Indication
Off	No spare battery in slot; spare battery not placed correctly; cradle is not powered.
Fast Blinking Amber	Error in charging; check placement of spare battery.
Slow Blinking Amber	Spare battery is charging.
Solid Amber	Charging complete.

Magnetic Stripe Reader (MSR)

This section describes how to set up and use the snap-on MSR with the EDA. The MSR snaps on to the bottom of the EDA and removes easily when not in use.

When attached to the EDA, the MSR allows the EDA to capture data from magnetic stripe cards. To download MSR data capture software, visit <http://www.zebra.com/support>.

Attaching and Removing the MSR

To attach, slide the MSR onto the bottom of the EDA and snap it in place.

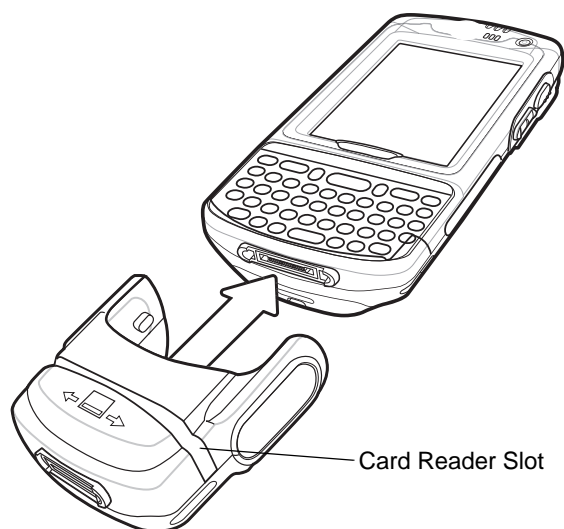

Figure 2-27 MSR Installation

To remove the MSR open the arms and pull the MSR from the EDA.

Using the MSR

The *MSR3000* sample application illustrates how an application handles MSR inputs (refer to *Applications User's Guide*).

To use the MSR:

1. Attach the MSR to the EDA.
2. Power on the EDA.
3. Tap **Start > MC70 Demo > Test Apps > MSR MC70** or **MSR Cameo** to start the sample application.
4. Swipe the magnetic stripe card through the MSR, with the magnetic stripe on the card facing down. Swipe the card in either direction, from left to right or from right to left. For best results, gently press down on the card while swiping to ensure contact with the bottom of the reader.

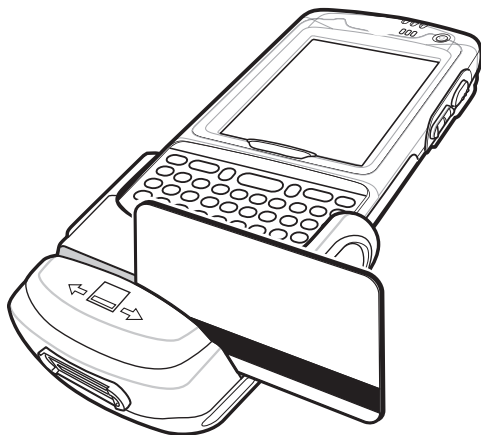

Figure 2-28 Magnetic Stripe Card Swiping

TRG7000 Trigger Handle

The TRG7000 Trigger Handle adds a gun-style handle with a scanning trigger to the EDA. It increases comfort when using the EDA in scan-intensive applications for extended periods of time. The TRG7000 is intended for use with MC70 WLAN/PAN configurations.

For cleat installation and communication setup procedures refer to the *MC70 Integrator Guide*.

Installing the Trigger Handle Cleat

The Trigger Handle comes with a trigger handle cleat that replaces the back housing bracket on the EDA.

CAUTION The trigger handle cleat secures the EDA into the Trigger Handle and prevents the EDA from slipping out of the Trigger Handle. Failure to install the cleat may result in damage to the EDA.

1. Remove the handstrap by threading the handstrap through the handstrap slot.
2. Remove the four screws securing the back housing bracket to the EDA. Save these screws to use them later to secure the trigger handle cleat.
3. Remove the back housing bracket.

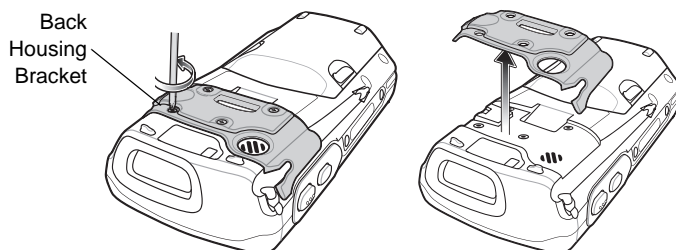

Figure 2-29 Removing Back Housing Bracket

4. Install the rubber headset jack dust cover onto the trigger handle cleat.
5. Align the trigger handle cleat onto the EDA.
6. Secure the trigger handle cleat to the EDA using the four screws saved during step 2.

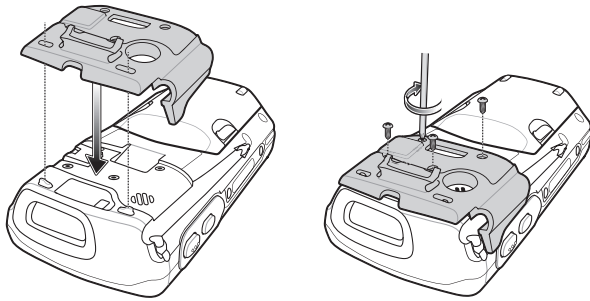

Figure 2-30 *Installing the Cleat*

7. Feed the handstrap through the handstrap slot and secure.

Inserting the EDA into the Trigger Handle

Slide the EDA into the Trigger Handle until it locks in place. The release secures the EDA to the Trigger Handle.

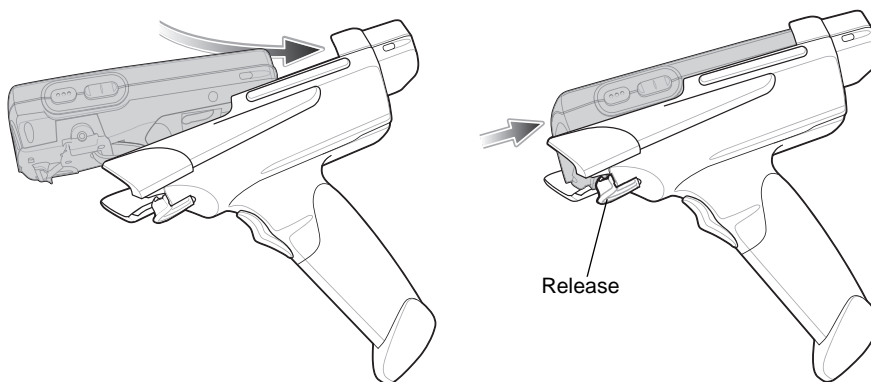

Figure 2-31 *Inserting the EDA into the Trigger Handle*

Removing the EDA

To remove the EDA, press the release down and pull the EDA forward.



Figure 2-32 *Removing the EDA*

Using a Cradle

With the Trigger Handle you can charge the EDA and communicate with a host computer using either the serial charging cable or a cradle, or connect to a peripheral such as a printer.

Using the Serial Charging/Communication Cable

To charge the EDA's battery or communicate with a host computer while the EDA is in the Trigger Handle, set up the EDA as shown in [Figure 2-33](#).

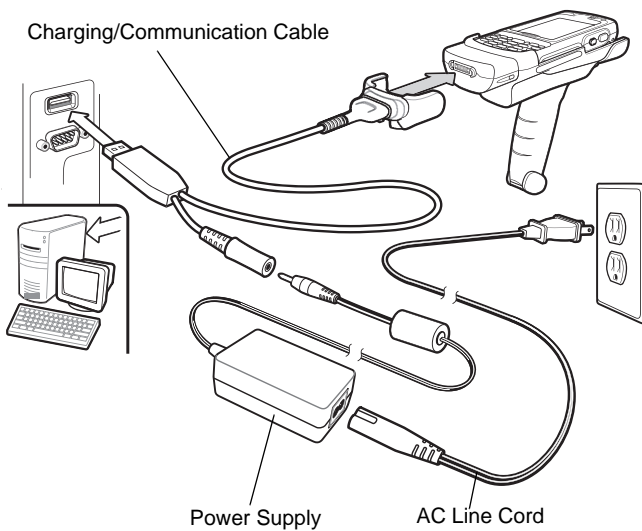

Figure 2-33 Trigger Handle Setup

CAUTION Do not place a Trigger Handle with an attachment, such as a Magnetic Stripe Reader (MSR), into a cradle. Remove the attachment before inserting the Trigger Handle into the cradle.

To charge the EDA's battery while the EDA is in the Trigger Handle, insert the EDA into either the Single Slot USB/Serial cradle or the Four Slot Ethernet cradle.

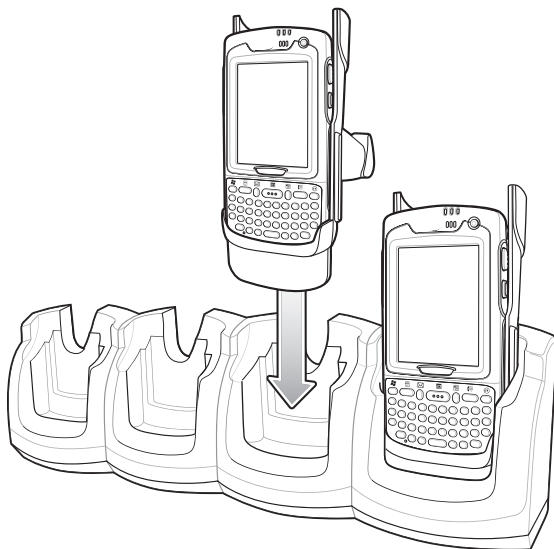

Figure 2-34 Inserting the EDA Into the Cradle for Charging

Cables

This section describes how to set up and use the cables. The cables are available with a variety of connection capabilities.

The following MC70 communication/charge cables are available:

- Serial (RS232) Charge cable (9-pin D female with power input receptacle)
- USB Client Charge cable (standard-A connector and a barrel receptacle for power)
- Auto charge cable
- DEX cable
- Modem inverter cable.

The following printer cables are available directly from the printer manufacturer:

- O'Neil Printer cable
- Zebra Printer cable.

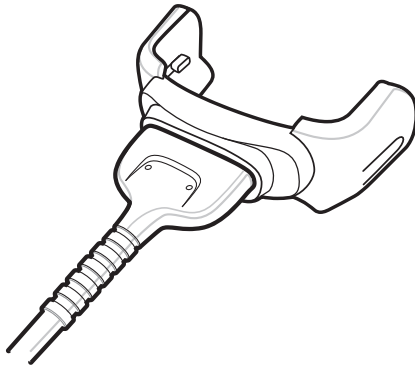

Figure 2-35 Cables (MC70 Connector)

The communication/charge cables:

- Provide the EDA with operating and charging power when used with the approved power supply.
- Synchronize information between the EDA and a host computer. With customized or third party software, it can also synchronize the EDA with corporate databases.
- Provide serial connection through the serial pass-through port for communication with a serial device, such as a host computer. For communication setup procedures, see [Communication Setup on page 2-28](#).
- Provide USB connection through the USB pass-through port for communication with a USB device, such as a host computer. For communication setup procedures, see [Communication Setup on page 2-28](#).

Dedicated printer cables provide communication with a printer.

Setup

The EDA communication/charge cables can connect with a serial/USB device, such as a printer or host computer, through its serial or USB port.

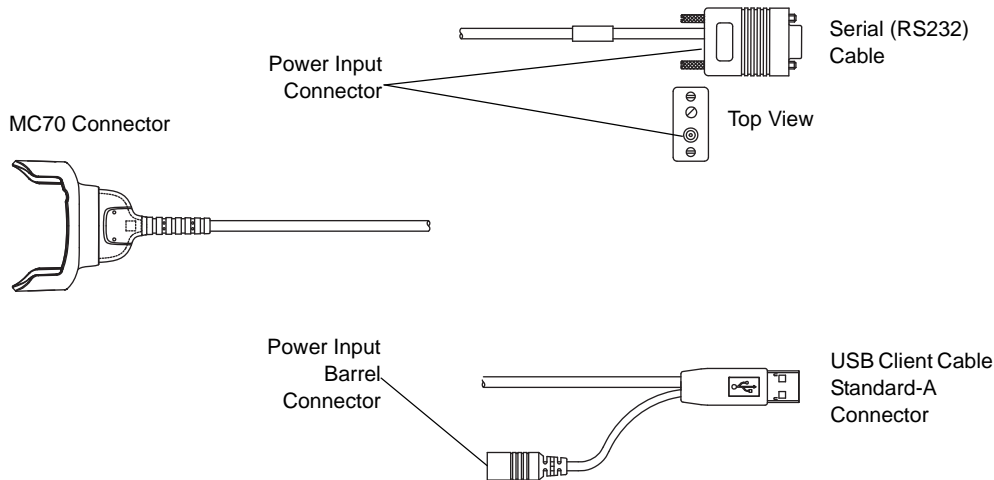

Figure 2-36 Communication/Charge Cables

Battery Charging

The communication/charge cables can charge the EDA battery and supply operating power.

To charge the EDA battery:

1. Connect the communication/charge cable power input connector to the approved power source.
2. Slide the bottom of the EDA into the connector end of the communication/charge cable and gently press in until it latches into the EDA. The EDA amber Charge LED indicates the EDA battery charging status. See [Table 1-2 on page 1-6](#) for the amount of time required for battery charging. See [Table 1-3 on page 1-6](#) for charging status indications.
3. When charging completes, remove the cable by gently pulling the EDA and the cable apart.

LED Charge Indications

The amber Charge LED on the EDA indicates battery charging status. See [Table 1-3 on page 1-6](#) for charging status indications.

Charging Temperature

Charge batteries in temperatures from 0°C to 40°C (32°F to 104°F). Note that at temperatures above 35°C, charging is intelligently controlled by the EDA in order to ensure safe operation and optimize long-term battery life.

To accomplish this, for small periods of time, the EDA alternately enables and disables battery charging to keep the battery at acceptable temperatures. The EDA indicates when charging is disabled due to abnormal temperatures via its LED. See [Table 1-3 on page 1-6](#).

Communication Setup

To connect an EDA communication/charge cable to a serial or USB device:

1. Connect the serial/USB end of the EDA communication/charge cable to the communication port of the device.
2. Connect the EDA connector end of the cable to the EDA. For more information on communication setup procedures, see [Chapter 3, ActiveSync](#).

Chapter 3 ActiveSync

Introduction

To communicate with various host devices, install Microsoft ActiveSync (version 4.5 or higher) on the host computer. Use ActiveSync to synchronize information on the mobile computer with information on the host computer. Changes made on the mobile computer or host computer appear in both places after synchronization.

- ✓ **NOTE** When a mobile computer with Windows Mobile 5.0/6.1 is connected to a host computer and an ActiveSync connection is made, the WLAN radio (if applicable) is disabled. This is a Microsoft security feature to prevent connection to two networks at the same time.

ActiveSync software:

- Allows working with mobile computer-compatible host applications on the host computer. ActiveSync replicates data from the mobile computer so the host application can view, enter, and modify data on the mobile computer.
- Synchronizes files between the mobile computer and host computer, converting the files to the correct format.
- Backs up the data stored on the mobile computer. Synchronization is a one-step procedure that ensures the data is always safe and up-to-date.
- Copies (rather than synchronizes) files between the mobile computer and host computer.
- Controls when synchronization occurs by selecting a synchronization mode, e.g., set to synchronize continually while the mobile computer is connected to the host computer, or set to only synchronize on command.
- Selects the types of information to synchronize and control how much data is synchronized.

Installing ActiveSync

To install ActiveSync on the host computer, download version 4.5 or higher from the Microsoft web site at <http://www.microsoft.com>. Refer to the installation included with the ActiveSync software.

Mobile Computer Setup

✓ **NOTE** Microsoft recommends installing ActiveSync on the host computer before connecting the mobile computer.

The mobile computer can be set up to communicate either with a serial connection or a USB connection. [Chapter 2, Accessories](#) provides the accessory setup and cable connection information for use with the mobile computer. The mobile computer communication settings must be set to match the communication settings used with ActiveSync.

1. On the mobile computer tap **Start > Programs > ActiveSync** icon. The **ActiveSync** window appears.

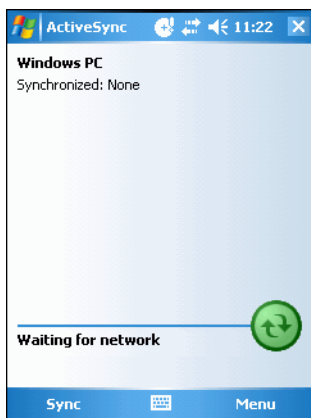

Figure 3-1 ActiveSync Window

2. Tap **Menu > Connections**.
3. Select the connection type from the drop-down list.
4. Tap **OK** to exit the **Connections** window and tap **OK** to exit the **ActiveSync** window.
5. Proceed with installing ActiveSync on the host computer and setting up a partnership.

Setting Up an ActiveSync Connection on the Host Computer

To start ActiveSync:

1. Select **Start > Programs > Microsoft ActiveSync** on the host computer. The **ActiveSync** Window displays.

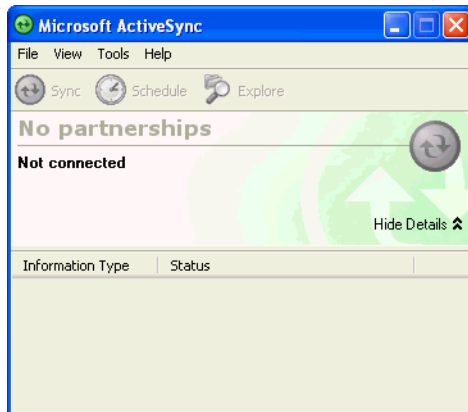

Figure 3-2 ActiveSync Window

- ✓ **NOTE** Assign each mobile computer a unique device name. Do not try to synchronize more than one mobile computer to the same name.

2. In the **ActiveSync** window, select **File > Connection Settings**. The **Connection Settings** window appears.



Figure 3-3 Connection Settings Window

3. Select the appropriate check box for the type of connection used.
4. Select the **Show status icon in Taskbar** check box.
5. Select **OK** to save any changes made.

Synchronization with a Windows Mobile 5.0/6.1 Device

- ✓ **NOTE** When a mobile computer with Windows Mobile 5.0/6.1 is connected to a host computer and an ActiveSync connection is made, the WLAN radio (if applicable) is disabled. This is a Microsoft security feature to prevent connection to two networks at the same time.

To synchronize with a Windows Mobile 5.0/6.1 device:

1. If the **Get Connected** window does not appear on the host computer, select **Start > All Programs > Microsoft ActiveSync**.

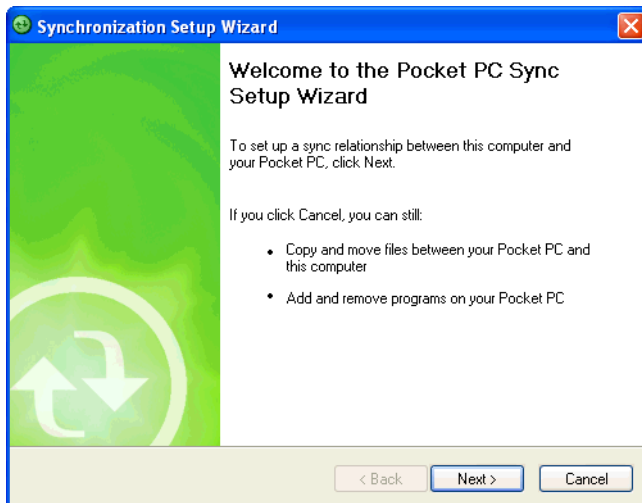

Figure 3-4 *Synchronization Setup Wizard Window*

2. Click **Next**.

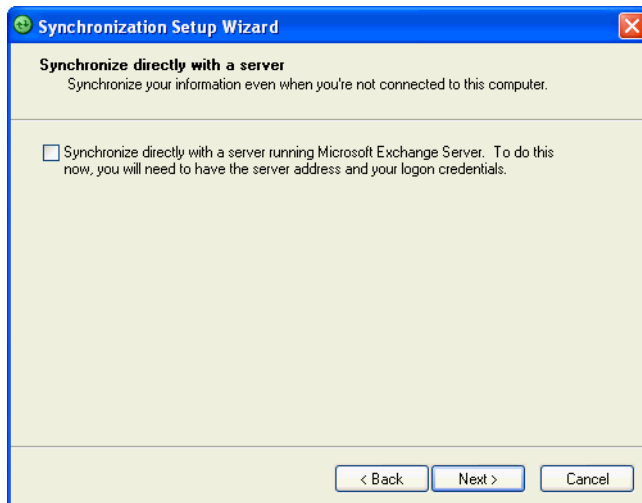

Figure 3-5 *Synchronization Directly With a Server Window*

3. Select the check box to synchronize with a server running Microsoft Exchange if applicable.

4. Click **Next**.

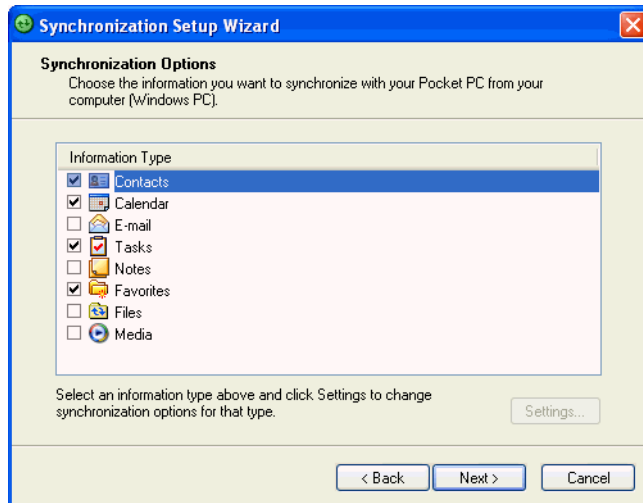

Figure 3-6 *Synchronization Option Window*

5. Select the appropriate settings and click **Next**.

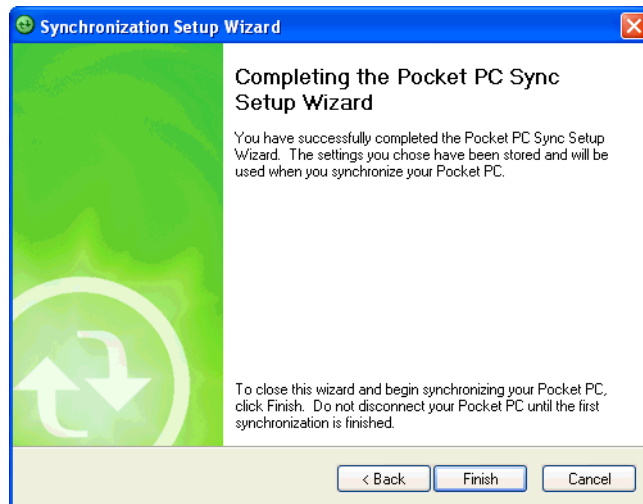

Figure 3-7 *Wizard Complete Window*

6. Click **Finish**.

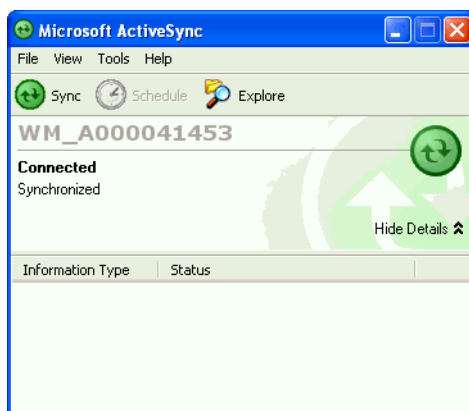

Figure 3-8 *ActiveSync Connected Window*

During the first synchronization, information stored on the mobile computer is copied to the host computer. When the copy is complete and all data is synchronized, the mobile computer can be disconnected from the host computer.

✓ **NOTE** The first ActiveSync operation must be performed with a local, direct connection. Windows Mobile retains partnerships information after a cold boot.

For more information about using ActiveSync, start ActiveSync on the host computer, then see ActiveSync Help.

Chapter 4 Application Deployment for Windows Mobile

Introduction

This chapter describes new features in Windows Mobile including new security features, how to package applications, and procedures for deploying applications onto the EDA.

Security

The MC70 EDAs implement a set of security policies that determine whether an application is allowed to run and, if allowed, with what level of trust. To develop an application, you must know the security configuration of the device, and how to sign an application with the appropriate certificate to allow the application to run (and to run with the needed level of trust).

Application Security

Application security controls the applications that can run on the EDA.

- Trusted - All applications must be digitally signed by a certificate on the EDA.
- Prompted - User is prompted to allow unsigned applications to run.
- Open - All applications run.

Developers can include their own certificates and provision the device to “trusted.”

Digital Signatures

Digital signatures provide a way to authenticate the author of EXEs, DLLs, and packages. Digitally signed applications give users confidence that an application comes from where they think it comes from. For example, if an end-user downloads an update package from the internet that is digitally signed with Zebra's software certificate, they are assured that the package is authentic and that it was created by Zebra. By enforcing the use of digital signatures, users can also prevent malicious applications from executing on the EDA. For example, users can provision the EDA to only execute “trusted” applications (digitally signed).

Zebra ships all Windows Mobile based products in an “open” state, which means all signed and unsigned applications should work. However, customers can still reconfigure their EDAs to operate in the “trusted” mode.

This means that only applications signed with a certificate from the Privileged Execution Trust Certificate Store can run.

To support the broadest number of deployments, third-party software developers should perform the following when releasing software for a Windows Mobile 5.0 devices:

- Sign all their EXEs & DLLs with their private key
- Provide the corresponding public certificate to end-users so that it can be installed into Privileged Execution Trust Certificate Store.

If the software is installed via a .CAB file, developer should also:

- Sign the .CAB file with their private key
- Provide the corresponding public certificate to end-users so that it can be installed into SPC Certificate Store.

Locking Down a Mobile Computer

Like most configuration options in Windows Mobile, security settings are set via XML provisioning. For example, to enforce the “trusted” model and only allow applications signed with a privileged certificate to run, use the following provisioning document:

```
<wap-provisioningdoc>
  <characteristic type="SecurityPolicy">
    <!-- Disallow unsigned apps -->
    <parm name="4102" value="0"/>

    <!-- No Prompt -->
    <parm name="4122" value="1"/>
  </characteristic>
</wap-provisioningdoc>
```

For more information on various security options, refer to the Security Policy Settings topic in the latest Windows Mobile documentation.

Installing Certificates

Use XML provisioning to query and delete certificates from certificate stores. To add a new certificate the Privileged Execution Trust Certificate Store, use the following sample provisioning document:

```
<wap-provisioningdoc>
  <characteristic type="CertificateStore">
  <characteristic type="Privileged Execution Trust Authorities">
  <characteristic type="657141E12FA45786F6A57CA6464032D4B3A55475">
  <parm name="EncodedCertificate" value="
This is sample text. This is sample text. This is sample text. This is sample text.
This is sample text. This is sample text. This is sample text. This is sample text.
This is sample text. This is sample text. This is sample text. This is sample text. ="/>
  </characteristic>
  </characteristic>
  </characteristic>
</wap-provisioningdoc>
```

To create your own provisioning document with real certificate information:

1. Obtain a certificate from a security provider such as VeriSign.
2. Double-click on the certificate file (.CER) to open it.
3. Click on the *Details* tab and locate the *Thumbprint* field.
4. Copy the contents of the *Thumbprint* field and replace the value in the XML example above.
5. Click the **Copy to File...** button.
6. Click **Next** to start the Certificate Export Wizard.
7. Select *Base-64 encoded X.509 (.CER)* and then click **Next**.
8. Set the File Name to CertOutput.xml and click **Next**.
9. Click **Finish** to export the certificate.
10. Open the exported file, CertOutput.xml, in a text editor (i.e., NotePad).
11. Copy the contents of the file (excluding the first line, last line, and CR/LF) and replace the value of the *"EncodedCertificate"* parameter in the xml example above.

Device Management Security

You can control access to certain device settings and security levels, such as installing applications and changing security settings. Refer to the *Windows Mobile Version 5.0 Help* file for information on device management security.

Remote API Security

The Remote API (RAPI) enables applications that run on a desktop to perform actions on a remote device. RAPI provides the ability to manipulate the file system on the remote device, including the creation and deletion of files and directories. By default, Zebra ships with RAPI in the restricted mode. Certain tools, such as RAPIConfig, may

not work properly. Refer to the *Windows Mobile Version 5.0 Help* file for finding information on Remote API security policies.

Packaging

✓ **NOTE** Applications compiled for Windows Mobile are not backward-compatible with previous versions.

Packaging combines an application's executable files into a single file, called a package. This makes it easier to deploy and install an application to the EDA. Package new applications and updates, such as new DLL files, as CAB files, then deploy them to Windows Mobile devices. Refer to the *Microsoft Windows Mobile 5.0 Help* file for information on CAB files.

Deployment

To install applications onto the EDA, developers package the application and all required files into a CAB file, then load the file onto the EDA using one of the following options:

- Microsoft ActiveSync 4.5 or higher
- Storage Card
- AirBEAM
- MSP 3.X
- Image Update (for updating the operating system).

Refer to the *Microsoft Windows Mobile 5.0 Help* file for information on CAB files.

Installation Using ActiveSync

To install an application package:

- Connect the EDA to a host computer using ActiveSync. See [Chapter 3, ActiveSync](#) for more information.
- Locate the package file on the host computer.
- In ActiveSync on the host computer, open *Explorer* for the EDA.
- Copy the CAB file from the host computer to the \temp directory on the EDA.
- On the EDA, navigate to the \temp directory.
- Tap on the application CAB file. The application installs on the EDA.

Installation Using Storage Card

To install an application package:

- Copy the package CAB file to a storage card using an appropriate storage card reader.
- Install the storage card into the EDA. See [Multi Media Card \(MMC\) / Secure Digital \(SD\) Card on page 2-2](#) for more information.
- On the EDA, open *File Explorer*.

- Open the *Storage Card* directory.
- Tap the package CAB file. The application installs on the EDA.

Installation Using AirBEAM

The AirBEAM Smart Client provides backward-compatible legacy AirBEAM functionality and backward-compatible legacy MSP 2.x Level 2 Agent functionality.

Refer to the AirBEAM Smart Windows CE Client Product Reference Guide, p/n 72-63060-01, for instructions for AirBEAM Smart client.

MSP 3.X

The MSP 3 Client Software is a set of software components that come pre-installed on the MC55. The MSP 3 Client software consists of the following components:

The RD Client provides support for MSP 3 Staging functionality, provides support for the MSP 3 Legacy Staging process, and provides support for backward-compatible legacy MSP 2.x Legacy Staging functionality.

The MSP 3 Agent provides MSP 3 Provisioning functionality and Control functionality when used with MSP 3.2 Control Edition.

Refer to the Mobility Services Platform 3.2 User's Guide, p/n 72E-100158-06, for instructions for using the Rapid Deployment and MSP3 Agent clients.

Image Update

Windows Mobile contains an Image Update feature that updates all operating system components. All updates are distributed as update packages. Update packages can contain either partial or complete updates for the operating system. Zebra distributes the update packages on the Support Central Web Site, <http://www.zebra.com/support>.

To update an operating system component, copy the update package to the EDA using one of a variety of transports, including ActiveSync, an SD memory card, or AirBEAM. Then, initiate the update using one of the following methods:

- Double-tap the package file in *File Explorer* (similar to extracting a CAB file)
- Perform a special boot sequence that initiates the update.
- Use AirBEAM.

✓ **NOTE** The EDA must have at least 5 MB of free space to perform an OS update.

To initiate an update:

1. Go to the Support Central web site, <http://www.zebra.com/support>.
2. Download the appropriate update package.
3. Copy the update package to either the \temp directory on the EDA, or to a storage card.
4. Connect the EDA to AC power. See [Chapter 2, Accessories](#).
5. Simultaneously press the **Power** button and the 1 and 9 keys.
6. Immediately, as soon as the device starts to boot and before the splash screen is visible, press and hold the left scan button.

7. The Update Loader application first looks for a file on a storage card. If it does not find it, it looks in the \temp directory.

When it finds the appropriate file, it loads the package onto the EDA. A progress bar displays until the update completes.

8. The EDA re-boots.
9. The calibration screen appears.

✓ **NOTE** When initiating an update via a boot sequence, the update loader looks for updates first on the root of an installed SD card and then in the \temp folder on the EDA's persistent storage volume. A response file, pkgs.lst, indicates which files to update. In most cases, Zebra provides this pkgs.lst file with the update and you should only modify it when updating a splash screen partition. See [Creating a Splash Screen](#) for more information.

Creating a Splash Screen

Use a bitmap file to create a customized splash screens for the EDA. Use Image Update with a bitmap file, rather than a package file, to update the splash screen.

To create a custom splash screen:

1. Create a .bmp file using a graphic program with the following specifications:
 - Size: 240 x 296.
 - Colors: 8 bits per pixel (256 colors) for color displays.

2. Modify the bitmap file and save.

To load the splash screen on the EDA:

1. Create a text file named pkgs.lst which contains the name of the bmp file. For example, *mysplash.bmp*.
2. Copy the bmp file and the pkgs.lst file to one of the following:
 - SD card root directory
 - EDA's \temp directory
 - EDA's \Windows directory.
3. If using an SD card, insert the SD card into the EDA.
4. Perform a cold boot.
5. Press the trigger or side scan button for 5 seconds while booting to invoke the Update Loader and install the splash screen.

XML Provisioning

To configure the settings on an EDA, use XML provisioning. To install an XML provisioning file on the EDA, create a Cabinet Provisioning File (CPF). A CPF file is similar to a CAB file and contains just one file: *_setup.xml*. Like a CAB file, the CPF extension is associated with WCELoad.EXE. Opening a CPF extracts the XML code and uses it to provision and configure the EDA. The user receives an e-mail notification indicating success or failure.

XML provisioning provides the ability to configure various features of the EDA (i.e., registry and file system). However, some settings require security privileges. To change registry settings via a CPF file, you must have

certain privileges (roles). Some registry keys require you to simply be an *Authenticated User*, while other registry keys require you to be a *Manager*. Refer to the *Microsoft Windows Mobile 5.0 Help* file, *Metabase Settings for Registry Configuration Service Provider* section, for the default role settings in Windows Mobile 5.0.

For those registry settings that require the *Manager* role, the CPF file must be signed with a privileged certificate installed on the device. Refer to the *Microsoft Windows Mobile 5.0 Help* file and the *Windows Mobile 5.0 SDK* for instructions and sample test certificates.

Creating an XML Provisioning File

To create a .cpf file:

1. Create a valid provisioning XML file named `_setup.xml` using an XML editor or the tools supplied with Visual Studio 2005. (For example, use the `SampleReg.xml` sample created in the [RegMerge](#) section and rename it `_setup.xml`.) Ensure the file contains the required parameters for the operation. Refer to the *Microsoft Windows Mobile 5.0 Help* file for information.
2. In the Windows Mobile 5.0 tools directory on the desktop computer (typically `\Program Files\Windows CE Tools\wce500\Windows Mobile 5.0 Pocket PC SDK\Tools`), run the `Makecab.exe` utility, using the following syntax to create a .cpf file from the `_setup.xml` file:

```
MakeCab.exe /D COMPRESS=OFF _setup.xml myOutCpf
```

✓ **NOTE** COMPRESS=OFF is required for backward compatibility with Pocket PC.

3. Optionally, use the `Authenticode` tools to sign the .cpf file.
4. Tap the filename to install.
5. Certain applications and settings require a cold boot to take affect. In these cases, cold boot the EDA. Refer to the *Windows Mobile Version 5.0 Help* file for more information.

XML Provisioning vs. RegMerge and Copy File

Prior to Windows Mobile, Zebra used two drivers (`RegMerge` and `CopyFiles`) to update the registry and to copy files during a cold boot. With Windows Mobile, Zebra recommends using XML provisioning instead. `RegMerge` and `CopyFiles` are supported for backward compatibility but Zebra may eliminate support in the future. The following sections provide examples of how `RegMerge` and `CopyFiles` were used, and how to perform the same function using XML provisioning.

RegMerge

`RegMerge.dll` is a built-in driver that allows updating the registry during a clean boot. `RegMerge` runs very early in the boot process and looks for registry files (.reg files) in certain Flash File System folders (i.e., `\Application`) during a clean boot. It then merges the registry changes into the system registry located in RAM.

The following example uses `RegMerge` to set a registry key:

SampleReg.reg

```
[HKEY_LOCAL_MACHINE\Hardware\DeviceMap\Backlight]
"BacklightIntensity"=dword:00000036
```

The following example uses XML provisioning to perform the same task:

SampleReg.xml

```
<wap-provisioningdoc>
  <characteristic type="Registry">
    <characteristic type="HKLM\Hardware\DeviceMap\Backlight">
      <parm name="BacklightIntensity" value="54" datatype="integer" />
    </characteristic>
  </characteristic>
</wap-provisioningdoc>
```

CopyFiles

CopyFiles copies files from one folder to another on a clean boot. During a clean boot CopyFiles looks for files with a .CPY extension in the root of the Application FFS partition. These files are text files containing the source and destination for the desired files to copy, separated by ">".

The following example uses CopyFiles to copy a file from the \Application folder to the \Windows folder:

SampleCpy.cpy

```
\Application\example.txt > \Windows\example.txt
```

The following example uses XML provisioning to perform the same task:

SampleCpy.xml

```
<wap-provisioningdoc>
  <characteristic type="FileOperation">
    <characteristic type="\Windows" translation="filesystem">
      <characteristic type="MakeDir"/>
      <characteristic type="example.txt" translation="filesystem">
        <characteristic type="Copy">
          <parm name="Source" value="\Application\example.txt" translation="filesystem"/>
        </characteristic>
      </characteristic>
    </characteristic>
  </characteristic>
</wap-provisioningdoc>
```

Storage

Windows Mobile contains three types of file storage:

- Random Access Memory (RAM)
- Persistent Storage
- Application folder.

Random Access Memory

Executing programs use RAM to store data. Data stored in RAM is lost upon a warm boot. RAM also included a volatile file storage area called *Cache Disk*.

Volatile File Storage (Cache Disk)

Windows Mobile memory architecture uses persistent storage for all files, registry settings, and database objects to ensure data is retained even after a power failure. Persistent storage is implemented using Flash memory technology which is generally slower than volatile RAM memory. In certain situations the speed of the operation is more important than the integrity of the data. For these situations, Zebra has provided a small volatile File Storage volume, accessed as the *Cache Disk* folder. Disk operations to the *Cache Disk* folder are much faster than to any of the persistent storage volumes, but data is lost across warm boots and power interruptions. Note that a backup battery powers RAM memory, including the *Cache Disk*, when you remove the main battery for a short period of time.

The EDA uses the *Cache Disk* for temporary data that can be restored from other sources, for example, for temporarily “caching” HTML web pages by a browser or generating formatted files to send to a printer. Both situations benefit from the increased speed of the cache disk, but you can restore the data if needed.

DO NOT use the *Cache Disk* as a method to improve application performance. Analyze applications that perform slower in persistent storage to optimize disk access. Common areas for optimization include minimizing the number of reads and writes to a file, removing unneeded debug logging, and minimizing file flushing or closing files.

Persistent Storage

Windows Mobile protects all data and applications from power-related loss. Because Windows Mobile mounts the entire file system and registry in persistent storage (rather than using RAM), MC70 devices provide a reliable storage platform even in the absence of battery power.

Persistent storage provides application developers with a reliable storage system available through the standard file system and registry APIs. Persistent storage is optimized for large reads and writes; therefore, applications reading and writing data in large chunks tend to outperform those applications reading and writing small blocks of data. Data in persistent storage is lost upon a clean boot.

Persistent storage contains all the directories under the root directory except for Application, Cache Disk, and Storage Card (if a storage card is installed). Persistent storage is approximately 60 MB (formatted).

Application Folder

The Application folder is a super-persistent storage that is persistent even after a clean boot. Accessing data in the Application folder is slower than accessing persistent storage. The Application folder is used for deployment and device-unique data. For example, network profiles can be stored in the Application folder so that connection to the network is available after a cold boot. The Application folder is approximately 20 MB (formatted).

System Configuration Manager

Symbol Configuration Manager (SCM) is a utility that runs on the host computer and is used to create configuration files. These files, when deployed to a vehicle computer, set configuration parameters for that device. The configurable options for a vehicle computer are defined in an XML file that is available on the Support Central. SCM is also available on Support Central.

SCM eliminates the potential user errors that occur when manually editing registry settings.

File Types

SCM uses three types of files:

- Symbol Configuration Template (.SCT) files are XML files that define the configurable parameters for a device.
- Registry Configuration Service Provider XML files for device provisioning.
- CAB Provisioning Format (.CPF) file which is a .CAB archive that contains the provisioning XML. This file is downloaded to the EDA and merged upon a cold boot.

User Interface

SCM's user interface consists of a tree control on the left side of the window which displays all the configuration categories, and a data grid table on the right which displays all the configurable controls for the selected category. [Figure 4-1](#) shows the main window for a device's .sct file.

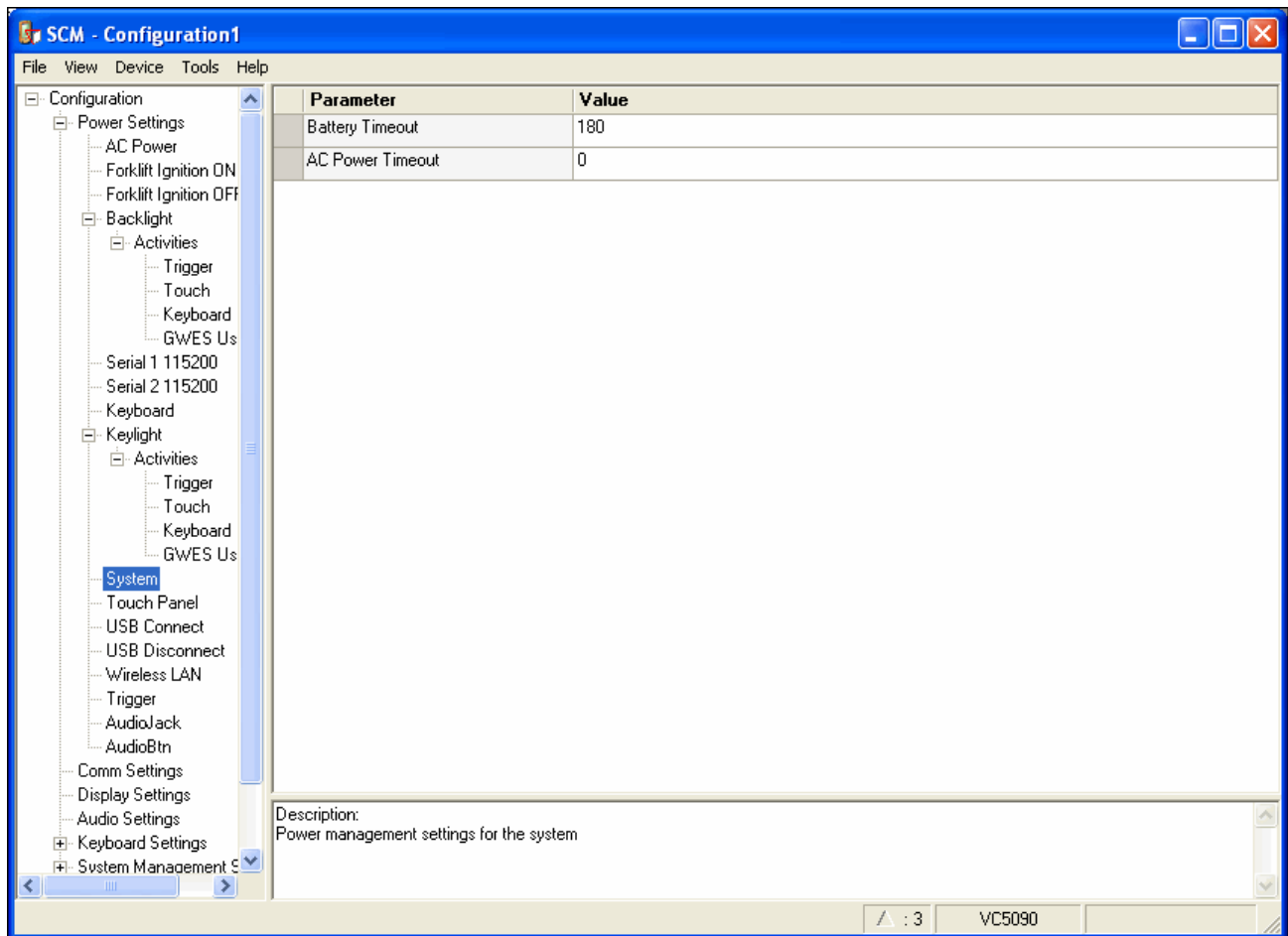

Figure 4-1 Main SCM Window

Menu Functions

Use the main menu to access the program functionality described in [Table 4-1](#).

Table 4-1 SCM Menu Functions

Menu Item	Description
File Menu	
Open Config File	Open a saved configuration file (.SCD).
Save Config Changes	Save changes to the currently loaded configuration file.
Restore All Defaults	Restore all parameter values to the default state. The default values are stored in a Symbol Configuration template file (i.e., VC5090.sct).
Get Defaults from Device	Load all parameter values from the current device.
Export Changes to .reg	Export the changed parameter values to an reg file.
Export Changes to .xml	Export the changed parameter values to an XML file.
Export Changes to .cpf	Export the changed parameter values to an CPF file.



Table 4-1 *SCM Menu Functions (Continued)*

Menu Item	Description
Export all to .reg	Export all the parameter values to an reg file.
Export all to .xml	Export all the parameter values to an XML file.
Export all to .cpf	Export all the parameter values to an CPF file.
Exit	Exit Symbol Configuration Manager.
Device Menu	
Device type	Change the current device type template. Each template (available from the Support Central) must reside in the SCM directory.
Tools Menu	
Signing Wizard	Adds a digital signature to a file.
Reg File Conversion Wizard	Converts a .reg file into a cpl or cab file.
Help Menu	
About	Display the <i>About</i> dialog which shows the application version.

Parameter State Indicators

The first column of the data table displays parameter state indicators. The state indicators display one of the states in [Table 4-2](#) for a particular parameter:

Table 4-2 *Parameter Status Indicators*

Icon	Indicator	Description
	Modified	This parameter was changed from its initial factory setting.
	Invalid	This parameter is not valid for the selected device type. This can occur when a configuration file for one type of device is loaded and the device type is changed using the Device menu. Values marked "invalid" are not included in an exported.

Window Status Bar

The SCM status bar found on the bottom right corner of the window contains the items in [Table 4-3](#) from left to right:

Table 4-3 *Window Status Bar Items*

Status Bar Item	Description
Invalid Count	Number of parameters not valid for the selected device.
Modified Count	Number of parameters modified from the factory defaults.
Device Type	Device type - version.

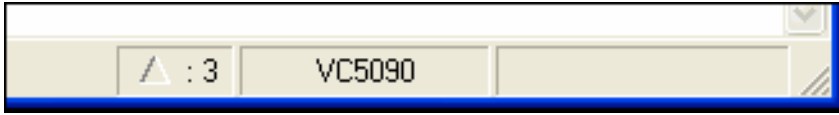

Figure 4-2 *Sample Status Bar*

The sample status bar in [Figure 4-2](#) shows that the current configuration file contains 3 modified parameters.

File Deployment

The .reg file created by the SCM export function must be deployed to the VC5090.

1. Select **File > Export changes to .reg** to create a .reg file for only the changes made or select **File > Export all to .reg** to create a .reg file for all settings.
2. Copy the .reg file to the vehicle computer.
3. Tap the filename to install.
4. Certain applications and settings require a cold boot to take affect. In these cases, cold boot the VC5090. Refer to the *Windows Mobile Version 5.0 Help* file for more information.

Enterprise Mobility Developer Kits

The Enterprise Mobility Developer Kit (EMDK) family of products allows you to write applications that take advantage of the capture, move and manage capabilities of Zebra EDAs. Go to the Support Central to download the appropriate developer kit.

Chapter 5 MC7004/94 - GSM Configuration

Introduction

This chapter explains how to verify MC7004/94 service on an Enhanced Data rates for Global Evolution (EDGE) wireless network and establish settings. EDGE is also known as Enhanced General Packet Radio Service (EGPRS).

EDGE networks deliver mobile voice and data services, such as Short Message Service (SMS)/Text Messaging, with full roaming capabilities across the world. General Packet Radio Service (GPRS) enabled networks offer Internet-based content and packet-based data services. This enables services such as internet browsing, e-mail on the move, powerful visual communications, multimedia messages, and location-based services.

When using the EDA as a phone, services can include speed dialing, call tracking, voice mail, call forwarding, conference calling, and caller ID, depending on the type of service.

Also use the integrated phone as a modem to connect the EDA to an ISP or work network. The GSM/GPRS enabled EDA can connect to the Internet or work network over GPRS, using Cellular Line, or using the modem specified by the mobile phone service provider.

- ✓ **NOTE** Before using an EDA on a wireless network, first select a provider, establish a voice and data-enabled service plan, and configure the EDA (where applicable). Refer to the *MC70 User Guide* for information on how to use the phone and services.

Quick Startup Steps

To use the EDA for phone and data connections:

1. Install the EDA main battery. See [Installing and Removing the Main Battery on page 1-3](#).
2. Charge the main battery and backup battery. See [Charging the Battery on page 1-5](#).
3. Install the SIM card. See [SIM Card on page 1-9](#).
4. Start the EDA.
5. Ensure network coverage ([page 5-2](#)).

6. Configure a GPRS data connection ([page 5-3](#)).

✓ **NOTE** Data connection configuration is pre-packaged with T-Mobile service. Other other service providers may require data connection configuration.

7. Configure settings ([page 5-7](#)).

8. Use the phone.

MC7004/94 Service Verification

MC7004/94 phone and data services require a live SIM card, obtained from a service provider, installed in the EDA phone/EDA. The SIM card has embedded circuitry on one side of its surface which, when inserted into an EDA phone, provides phone service on an EDGE network. The SIM card provides a phone number, determines the features or services available to the subscriber, and identifies the subscriber to the network.

In addition to SIM card installation, the EDA may require various settings to operate as a phone with data connection features.

Ensuring Network Coverage

1. Ensure an activated SIM card, from the phone service provider, is installed in the EDA.

✓ **NOTE** The SIM card must be GPRS enabled to connect to a GPRS network.

2. Verify active phone and data services by tapping  to display the *Phone* dialog. The network name appears in the dialog box.

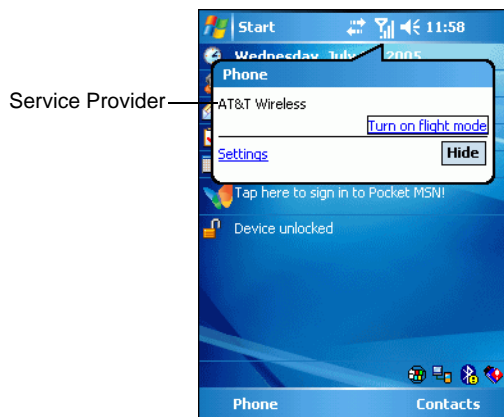

Figure 5-1 Connectivity Dialog

3. Verify SIM card functionality:
 - a. Tap **Start** > **Settings** > **Phone** icon > **Network** tab.

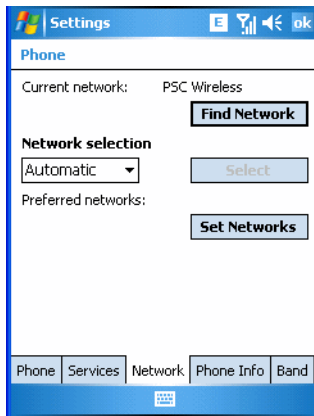



Figure 5-2 Phone Settings Window - Network Tab

- b. Ensure the service provider's network appears in the *Current network:* field.
- c. If the network does not appear, tap **Find Network**. If the network still does not appear, verify that the SIM card was installed correctly. If it was, and no network appears, contact the service provider.

Configuring a GPRS Data Connection

A GPRS data connection allows Internet access across a wireless network.

- ✓ **NOTE** Data connection is pre-packaged with T-Mobile service accounts. Other service providers may require the data connection configuration that follows.
- ✓ **NOTE** To verify active T-Mobile phone and data services, tap  to display the **Connectivity** dialog. Ensure the network name and 'G' (for GPRS, where available) appears in the dialog box.

To set up a new data connection:

1. Acquire an Access Point Name (APN) from the service provider.
2. Tap **Start > Settings > Connections tab > Connections icon > Tasks tab**.

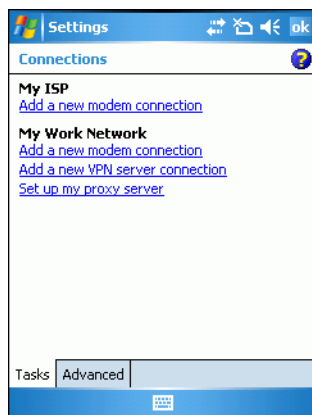

Figure 5-3 Connections Window

- Under **My ISP** select **Add a new modem connection**.

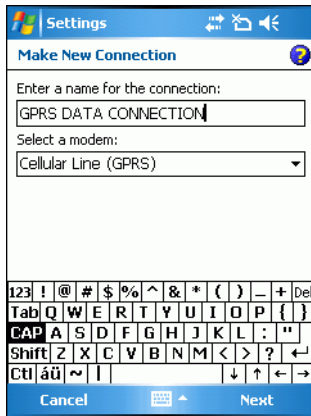

Figure 5-4 Connections Window - Make New Connection

- Enter a connection name in the *Enter a name for the connection:* text box.
- Select **Cellular Line (GPRS)** from the **Select a modem:** drop-down list.
- Tap **Next**.

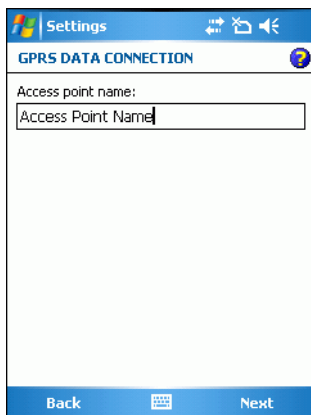

Figure 5-5 Connections Window - Access Point Name

- Enter the APN from the service provider in the **Access point name:** text box.
- Tap **Next**.

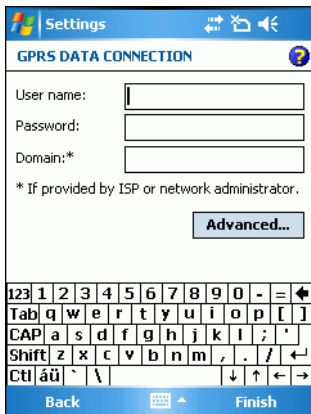

Figure 5-6 Connections Window - User Name & Password

9. Tap **Finish** (user name and password are not required).
10. Tap **ok** to exit **Connections**.

Establishing a Data Connection

1. Install a SIM card in the EDA.
2. Configure a GPRS data connection. See [Configuring a GPRS Data Connection on page 5-3](#).
3. Tap  at the top of the screen.

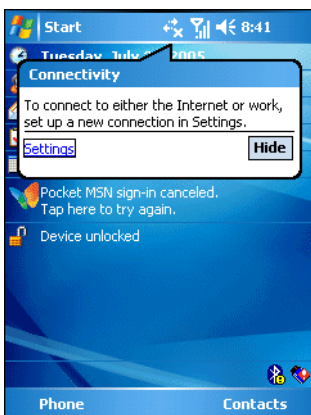

Figure 5-7 Connectivity Dialog

4. Tap **Settings**.
5. Tap **Managing existing connections**.
6. Tap and hold on the data connection until a menu appears.

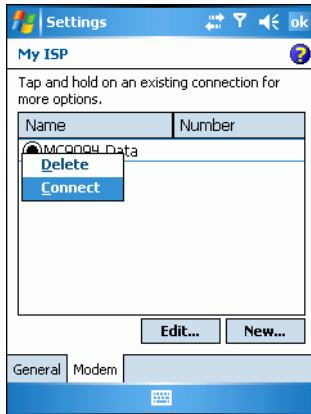

Figure 5-8 Data Connection

7. Select **Connect**.

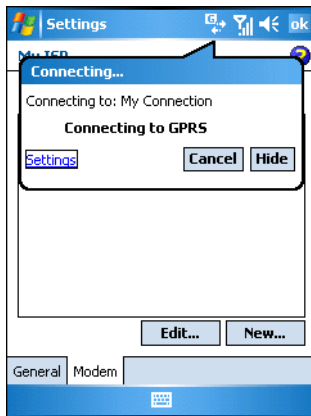

Figure 5-9 Connecting Using IDEN Packet Data Modem

8. If the SIM card is protected with a Personal Identification Number (PIN), a dialog box pops up requesting the appropriate PIN to unlock the SIM card. In this case, enter the PIN and tap **ok**.



NOTE Place emergency calls at any time, without entering a PIN or a SIM card.

9. When a connection is established, launch **Internet Explorer** to browse the Internet or launch an applicable application.

Ending a GPRS Data Connection

To cancel a data connection in progress, tap **Cancel** in the **Connecting...** dialog window.

To end an established data connection:

1. Tap  to display the dialog window.

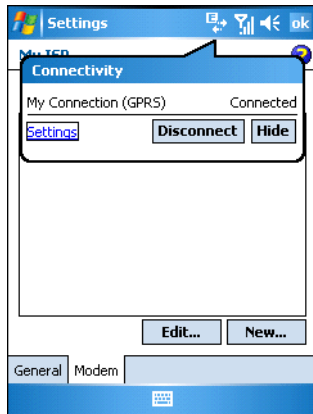

Figure 5-10 Connectivity Dialog Box

2. Tap **Disconnect**.

- ✓ **NOTE** Tapping **Disconnect** during an active data transfer (e.g., downloading a web page) automatically reconnects the GPRS connection. You cannot disconnect the GPRS connection until the data transfer is complete.

GPRS Settings

Use the **Phone Settings** window to customize settings, such as the ring type and ring tone for incoming calls, security options (GPRS), and other options depending on the type of service.

Phone

Use the **Phone** tab to customize ring type, ring tone, keypad tone, and security options.

Tap **Start > Settings > Personal tab > Phone icon > Phone tab**

or

Start > Phone > Menu > Options > Phone tab.

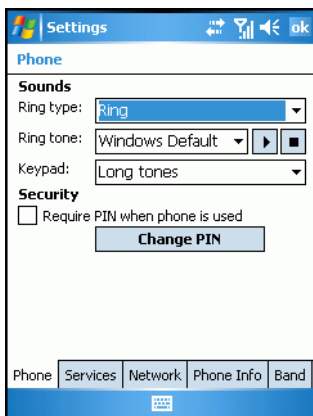



Figure 5-11 MC70 Phone Window - Phone Tab

Sounds

1. **Phone Number** automatically displays on the **Phone** tab when a live SIM card is installed.
2. Select a ring type from the **Ring type:** drop-down list. The ring type changes the way the EDA rings when you receive an incoming call. Regardless of the ring type selected, a dialog box appears on the EDA's display for incoming calls.
3. Select a ring tone for incoming calls from the **Ring tone:** drop-down list. To hear a sample of the selected ring tone, tap . Tap  to end the ring tone.
 - ✓ **NOTE** To use custom .wav, .mid, or .wma files as ring tones, use ActiveSync on the host computer to copy the file to the /Windows/Rings folder on the EDA. Then select the sound from the ring tone list.
4. Select a keypad tone from the **Keypad:** drop-down list. This selection determines the tone that sounds when entering a phone number on the keypad.
 - Select **Short tones** or **Long tones** to specify the duration of the sound when you press a number on the keypad.
 - Select **Off** to disable tones.

- ✓ **NOTE** Turning off sounds saves power and prolongs battery life.

Security

Enabling a PIN

- ✓ **NOTE** Place emergency calls at any time, without requiring a PIN or a SIM card.

To require a PIN when using the phone:

1. From the *Phone* tab (<Blue>Figure 5-11), select the **Require PIN when phone is used** check box under **Security**.

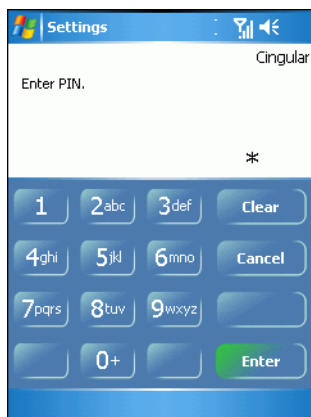

Figure 5-12 Enter PIN

2. Use the touch keypad to enter a four to eight digit PIN.
3. Tap **Enter** to enable the PIN and return to the **Phone** tab.

Changing a PIN

1. From the **Phone** tab (*Figure 5-11*), tap **Change PIN**.

2. Use the touch keypad to enter the current PIN.
3. Tap **Enter**.
4. Use the touch keypad to enter a new four to eight digit PIN.
5. Tap **Enter**.
6. Reenter the new PIN for confirmation and tap **Enter**.
7. Tap **ok** to confirm the change.

Disabling a PIN

1. From the **Phone** tab ([Figure 5-11](#)), deselect the **Require PIN when phone is used** check box.
2. Use the touch keypad to enter the current PIN.
3. Tap **Enter**.
4. Tap **ok** to confirm the change.
5. Tap **ok** to exit settings.

Services

Use the *Services* tab to configure settings for subscribed phone services. For example, block certain types of incoming and/or outgoing calls ([page 5-10](#)), disclose the caller's identity when making outgoing calls ([page 5-10](#)), forward incoming calls to a different phone number ([page 5-10](#)), receive notification of incoming calls when a phone session is in use ([page 5-11](#)), and set up voice mail and short message service ([page 5-11](#)).

1. Tap **Start > Settings > Personal tab > Phone icon > Services tab**.

or

Start > Phone > Menu > Options > Services tab.

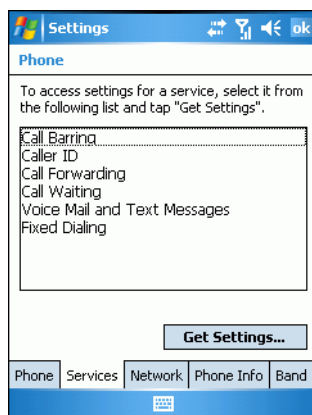

Figure 5-13 MC70 Phone Window - Services Tab

2. Select a service from the list and tap **Get Settings...**
3. Change services settings as follows.

Call Barring (Call Blocking)

Use call barring to block certain types of incoming and/or outgoing calls. Select the type of incoming and/or outgoing calls to block.

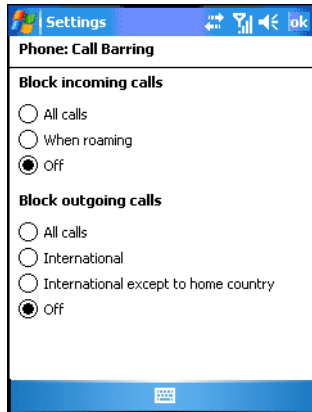

Figure 5-14 Call Barring/Call Blocking

Caller ID

Enable caller ID to reveal the identity of the person making an outgoing call. Select the **Everyone** radio button to always display the caller ID. Select the **No one** radio button to prevent the caller's identity from appearing to others.

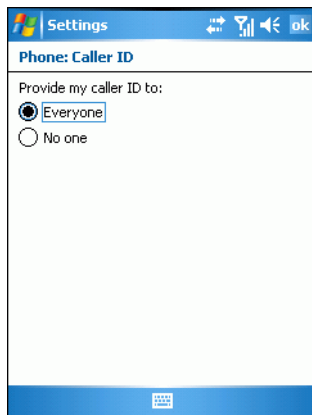

Figure 5-15 Caller ID

Call Forwarding

Use call forwarding to forward incoming calls to a different phone number.

- To forward all calls to a different phone number:
 - select the **Forward all incoming phone calls** check box.
 - enter the phone number to receive forwarded calls in the **To:** text box.

- To forward incoming calls to a different phone number based on a specific situation, select one or more of the check boxes under **Forward phone calls only if:**
 - **No answer:** enter the phone number to receive forwarded calls only when the phone cannot be answered. Then select a time period from the **Forward after:** drop-down list. Options are 5, 10, 15, 20, 25, and 30 seconds.
 - **Unavailable:** enter the phone number to receive forwarded calls only when the phone is turned off or the user is unreachable.
 - **Busy:** enter the phone number to receive forwarded calls only when the line is busy.

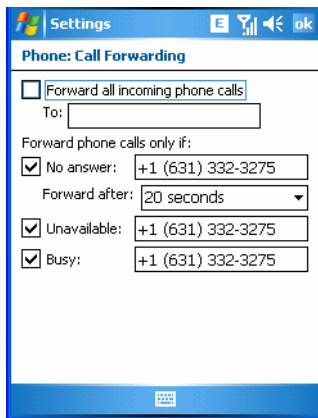

Figure 5-16 Call Forwarding

Call Waiting

Call waiting notifies you of an incoming call when the phone is in a phone session. Select the **Notify me** radio button to enable call waiting. Select the **Do not notify me** radio button to disable call waiting.

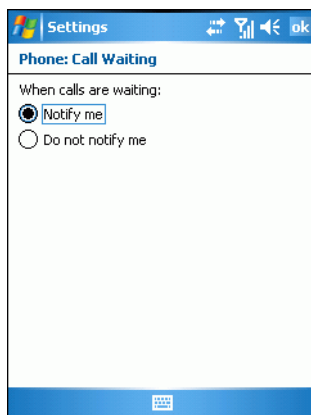

Figure 5-17 Call Waiting

Voice Mail and Text Messages

To use voice mail and send short messages, enter the voice mail and/or text message phone number in the appropriate text boxes.

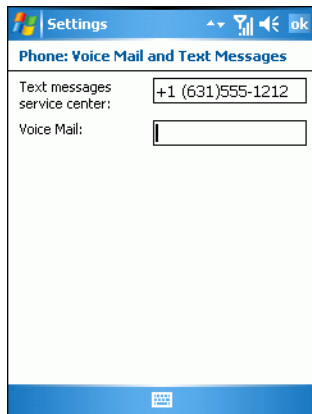

Figure 5-18 *Voice Mail and Text Messages*

Fixed Dialing

Use Fixed Dialing to restrict the phone to dial only the phone number(s) or area code(s) specified in a Fixed Dialing list.

1. Select **Fixed Dialing** and tap **Get Settings**.

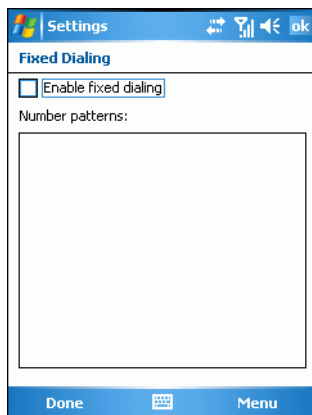

Figure 5-19 *Fixed Dialing Window*

2. Select the **Enable fixed dialing** check box.
3. To add a number to the list, tap **Menu > Add**.
4. Enter the phone number or area code to restrict and tap **Done**.
5. Repeat steps 3 and 4 to add more numbers, and tap **Done** twice when complete.
6. Enter **PIN2** and tap **Done**.

Network

Use the *Network* tab to view available networks, determine the order in which the phone accesses another network if the current network is unavailable, and specify whether to change networks manually or automatically. The current network remains active until it's changed, the signal is lost, or the SIM card is changed.

The network the EDA currently uses appears in the **Current network:** field at the top of the window.

Changing Networks Manually

1. Tap **Start > Settings > Personal tab > Phone icon > Network tab**

or

Start > Phone > Menu > Options > Network tab.

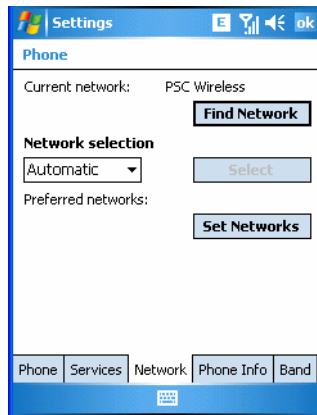

Figure 5-20 MC70 Phone Window - Network Tab

2. From the **Network selection** drop-down list, select **Manual**.

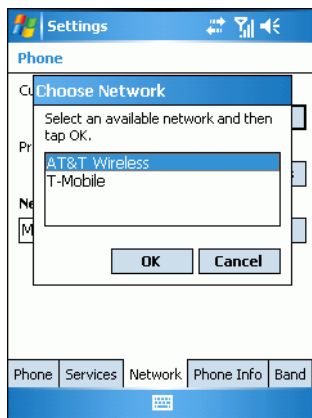

Figure 5-21 Choose Network

3. From the **Choose Network** window, select the network to use.
4. Tap **OK**.

Viewing Available Networks

To view all wireless networks available:

1. Tap **Start > Settings > Personal tab > Phone icon > Network tab**.

or

Start > Phone > Options > Network tab.

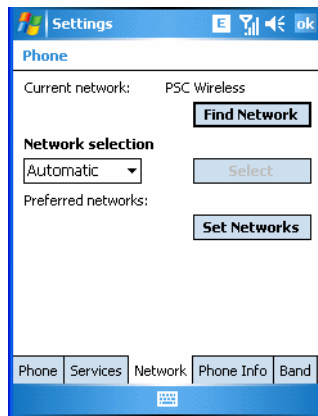

Figure 5-22 MC70 Phone Window - Network Tab

2. Tap Find Network.

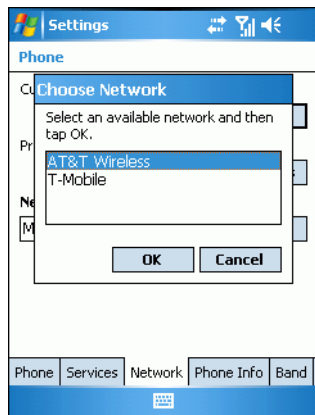

Figure 5-23 Choose Network

3. From the Choose Network window, select the network to use.

4. Tap OK.

Setting Preferred Networks

Set networks in a preferred order of access. Setting preferred networks allows the EDA to access a second preferred network if the first is unavailable.

1. Tap Start > Settings > Personal tab > Phone icon > Network tab

or

Start > Phone > Menu > Options > Network tab.

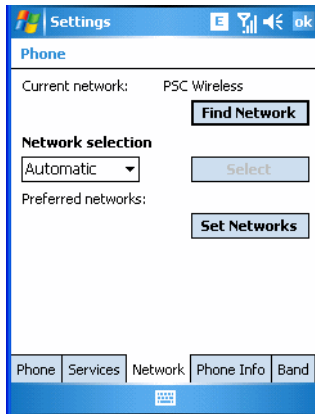

Figure 5-24 MC70 Phone Window - Network Tab

2. Tap **Set Networks** to view all available networks.

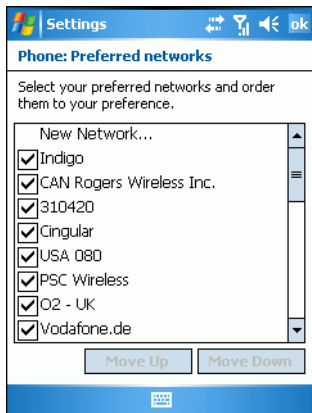

Figure 5-25 Preferred Networks

3. Select the preferred networks by tapping one or more check boxes.
4. Tap **Move Up** and **Move Down**, as necessary, to place the selected networks in the preferred order.
5. Tap **ok** to send the new settings to the network.
6. From the **Network** tab, select **Automatic** from the **Network selection** drop-down list.
7. Tap **ok** to exit settings.

Phone Info

Use the *Phone Info* tab to view hardware and software information about the phone.

1. Tap **Start > Settings > Personal tab > Phone icon > Phone Info** tab
or
Start > Phone > Menu > Options > Phone Info tab.

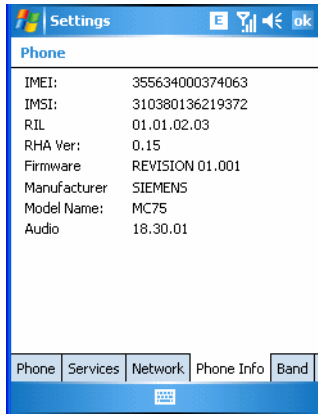

Figure 5-26 MC70 Phone Window - Phone Info Tab

2. Tap **ok** to exit settings.

Band



NOTE The *Band* tab appears only when MC70 configuration is installed on the EDA. Both the **850 MHz Enabled** and **Handover Enhancement Enabled** check boxes are checked (enabled) by default. Any changes made in this window do NOT persist after a cold boot (default settings are restored). Changes do persist after a warm boot.

1. Tap **Start > Settings > Personal tab > Phone icon > Band tab**

or

Start > Phone > Menu > Options > Band tab.

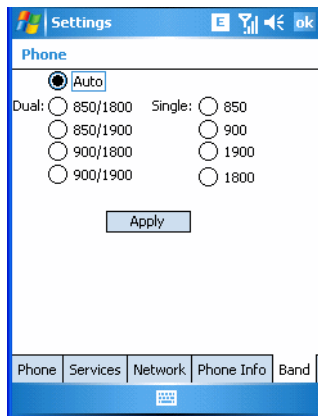

Figure 5-27 Phone Window - Band Tab

2. Select the **850 MHz Enabled** check box to enable the radio to hand over in the band of 850MHz (in addition to PCS1900MHz/DCS1800MHz).
3. Disable **Handover Enhancement** only for some special networks outside of the United States and Europe.
4. Tap **ok** to exit settings.

Chapter 6 MC7095 - CDMA Configuration

Introduction

This chapter explains how to activate an MC7095 EDA on a CDMA wireless network and establish settings.

CDMA is a form of wireless multiplexing in which data (e.g., Short Message Service) can be sent over multiple frequencies simultaneously, optimizing the use of available bandwidth. In an CDMA system data is broken into packets, each of which are given a unique identifier, so that they can be sent out over multiple frequencies and then re-built in the correct order by the receiver.

When using the MC7095 EDA as a phone, services can include speed dialing, call tracking, voice mail, call forwarding, conference calling and caller ID, depending on the type of service.

The integrated phone in the MC7095 can also be used as a modem to connect the MC7095 to an ISP or work network. The MC7095 can connect to the Internet or work network using Cellular Line, or using the modem specified by the mobile phone service provider.

- ✓ **NOTE** Before the MC7095 can be used on a CDMA wireless network, a provider must be selected, a voice and data-enabled service plan must be established and the MC7095 must be properly configured (where applicable).

Refer to the *MC70 User Guide* for information on how to use the phone and services.

Quick Startup Steps

- ✓ **NOTE** With active service from a provider, phone calls are established with or without a headset. A headset **MUST** be connected for all voice call conversations.

To start using the MC7095 for phone and data connections:

1. Install the MC7095 main battery ([Installing and Removing the Main Battery on page 1-3](#)).
2. Charge the main battery and backup battery ([Charging the Battery on page 1-5](#)).
3. Start the MC7095 (see [Powering On the EDA on page 1-7](#)).
4. Activate the phone ([MC7095 CDMA Phone Activation on page 6-2](#)).

5. Configure settings ([CDMA Settings on page 6-8](#)).
6. Use the phone.

MC7095 CDMA Phone Activation

CDMA phone service is available from a number of service providers including Sprint® and Verizon®. In addition to service activation for each provider, various settings may be required for the MC7095 to operate as a phone.

Sprint Activation

To activate the phone using Sprint service:

1. Contact Sprint to obtain a 6-digit activation code, also known as the Master Subsidy Lock (MSL) code, Mobile Directory Number (MDN) and Mobile Station ID (MSID).
2. Ensure the MC7095 is in a strong signal area.
3. Tap **Start > Phone > Menu > Activation Wizard...**

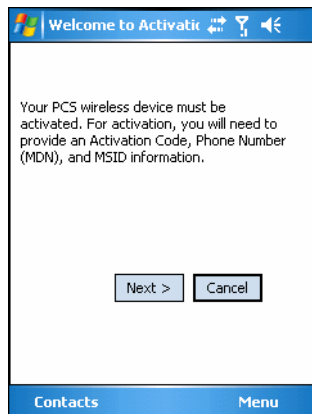

Figure 6-1 *Sprint Activation Wizard*

4. Tap **Next >**.

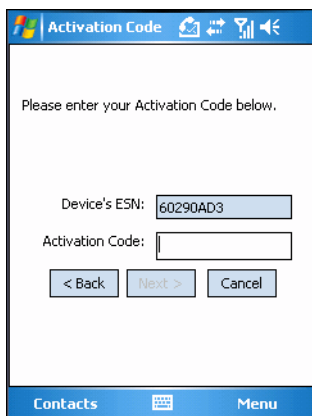

Figure 6-2 *Sprint Activation Wizard - Activation Code*

5. Enter the 6-digit activation code from your service provider.

6. Tap **Next >**.

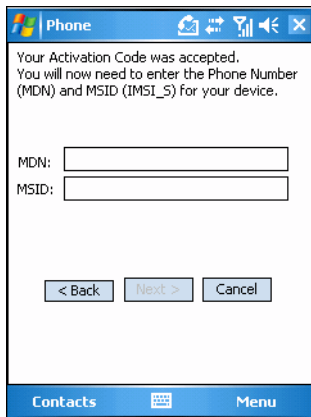

Figure 6-3 *Sprint Activation Wizard - MDN and MSID*

7. Enter the MDN and MSID. The MDN and MSID are the area code and phone number received from the service provider.

8. Tap **Next >**.

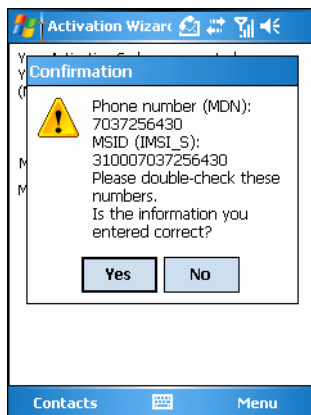

Figure 6-4 *Sprint Activation Wizard - Confirmation*

9. Verify that the MDN and MSIN numbers entered are correct, tap **Yes** to confirm.

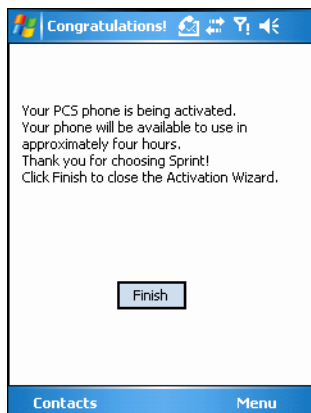

Figure 6-5 *Sprint Activation Wizard - Activation Complete*

10. Tap **Finish** to complete activation. The phone can be used in approximately four hours.

Sprint Activation Test

Approximately four hours after activation is completed, test the service.

1. Tap **Start > Phone**.

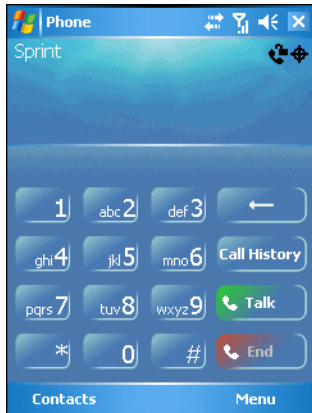

Figure 6-6 *Sprint Phone Window*

2. Ensure the Sprint name displays on the window.
3. Make a voice call to ensure activation was successful.

✓ **NOTE** If activation was not successful, contact the service provider.

4. Tap **Start > Phone > Menu > Options > Data Settings tab > Provision** to manually start an Internet-Over-The-Air (IOTA) session for a data connection. This data connection auto-updates the Vision profile (see [Data Settings on page 6-9](#)).

Verizon Activation

The Verizon Activation Wizard allows automatic activation. To activate the MC7095 using the automated service, the MC7095 attempts to call the network on a special number that automatically downloads the phone number and identification codes from the network.

Verizon automatically downloads the provisioning data. This process is invisible to the user and occurs once, after account activation, during the first data connection attempt.

✓ **NOTE** After an MC7095 is provisioned for Verizon wireless service, it is strongly recommended that no other service provider loads are downloaded to the MC7095 and no changes are made to any of the provisioning information.

To activate the phone using the Verizon automated service:

1. Ensure the MC7095 is in a strong signal area.
2. Tap **Start > Phone > Menu > Activation Wizard...**

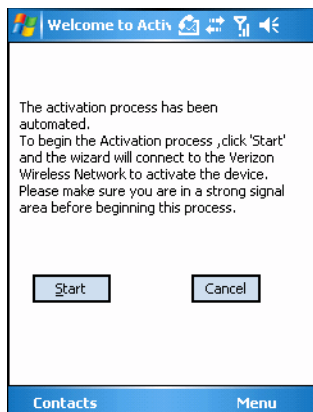

Figure 6-7 Verizon Activation Wizard

3. Tap **Start** to connect to the Verizon Wireless Network to automate activation. Automated activation provides all required codes and identification numbers over the network. No additional activation setup is required.

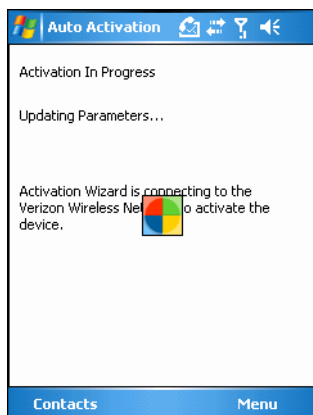

Figure 6-8 Activation in Progress

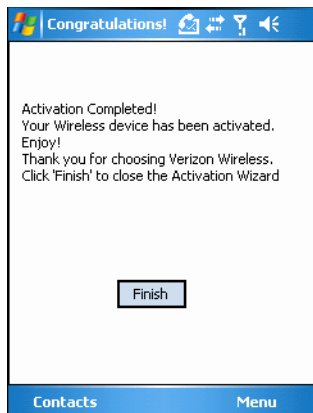

Figure 6-9 Activation Complete

4. Tap **Finish** to close the **Activation Wizard**.
5. Tap **Finish** to complete activation. The phone can be used in approximately four hours, depending on the network provider load.

Verizon Activation Test

Approximately four hours after activation is completed, test the service.

1. Tap **Start > Phone**.

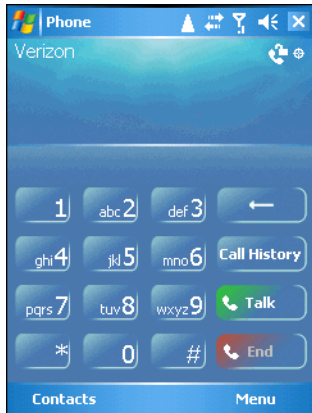

Figure 6-10 Verizon Phone Window

2. Ensure the Verizon name displays on the window.
3. Make a voice call to ensure activation was successful.

✓ **NOTE** If activation was not successful, contact the service provider.

Establishing a CDMA Data Connection

A CDMA data connection allows Internet access across a wireless network. Data connection is pre-packaged with service accounts.

To verify active data service:

1. Tap  to display the **Connectivity** dialog.



Figure 6-11 *Data Connection*

2. Tap #777 for a data connection using the Cellular Line.
or
3. Tap **Start > Internet Explorer**.
4. In the address bar, enter the URL for a web site.
5. Press **Enter**.

CDMA Settings

Use the **Phone Settings** window to customize CDMA phone settings, such as the ring type and ring tone for incoming calls and other options depending on the type of service.

Phone

Use the **Phone** tab to customize ring type, ring tone and keypad tone when entering phone numbers.

1. Tap **Start > Settings > Personal** tab > **Phone** icon > **Phone** tab.

or

Start > Phone > Menu > Options > Phone tab.

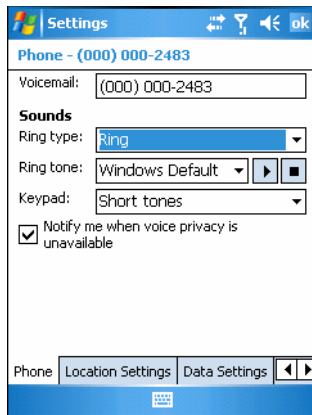



Figure 6-12 Phone Window - Phone Tab

2. Phone and voicemail phone numbers automatically display when phone service is activated.
3. Select a ring type from the **Ring type:** drop-down list. The ring type changes the way the MC7095 rings to notify the user of an incoming call. Regardless of the ring type selected, a dialog box appears on the display for incoming calls.
4. Select a ring tone for incoming calls from the **Ring tone:** drop-down list. To hear a sample of the selected ring tone, tap . Tap  to end the ring tone.

✓ **NOTE** To use custom .wav, .mid or .wma files as ring tones, use ActiveSync on the host PC to copy the file to the /Windows/Rings folder on the MC7095. Then, select the sound from the ring tone list.
5. Select a keypad tone from the **Keypad:** drop-down list. This selection determines the tone that sounds when entering a phone number on the keypad.
 - a. Select **Short Tones** for a tone that sounds only for one or two seconds.
 - b. Select **Long Tones** for a continuous sound for as long as the number on the keypad is pressed.
 - c. Select **Off** to disable tones.
6. Tap **Other Settings...** to set additional sounds and notifications for the MC7095.
7. Select the **Notify me when voice privacy is unavailable** check box to receive a message when dialing.

8. Tap **ok** to exit settings.

✓ **NOTE** Turning off sounds saves power and prolongs battery life.

Location Settings

Use the **Location** tab to allow the network to detect the position of the MC7095's radio.

1. Tap **Start > Settings > Personal tab > Phone icon > Location Settings** tab.

or

Start > Phone > Menu > Options > Location Settings tab.

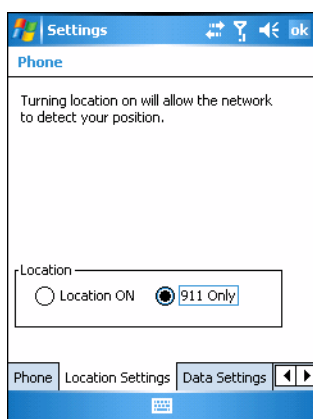

Figure 6-13 Phone Window - Location Tab (Typical)

2. Select the **Location ON** radio button to allow the network to detect the position of the MC7095's radio.
or
Select the **911** radio button to turn off location detection, hiding the location of the radio from all but 911 emergency service.
3. Tap **ok** to confirm **Location ON** or **911 Only**.
4. Tap **ok** again to exit settings.

Data Settings

Sprint Data Settings

Use the **Data Settings** tab to reset connection settings for PCS Vision and update the Vision profile, and to start IP-based Over-The-Air (IOTA) provisioning.

1. Tap **Start > Settings > Personal tab > Phone icon > Data Settings** tab.

or

Start > Phone > Menu > Options > Data Settings tab.

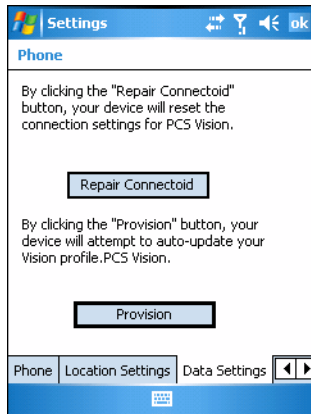

Figure 6-14 Phone Window - Sprint Data Tab

2. Tap **Repair Connectoid** to reset PCS Vision connection settings.

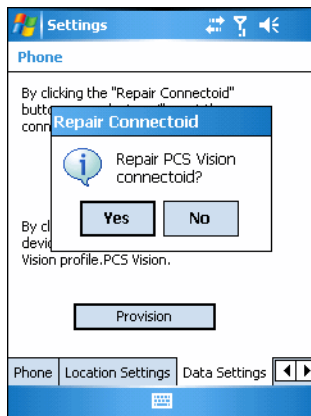

Figure 6-15 Reset Connection Settings Dialog

3. Tap **Yes**.

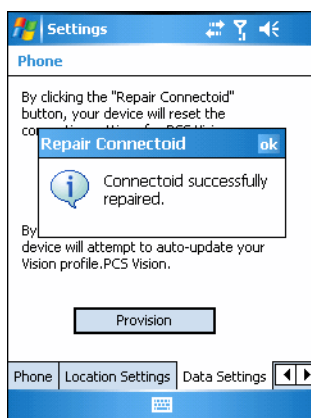

Figure 6-16 Reset Connection Completed Dialog

4. Tap **ok**.
5. Tap **Provision** to manually start IP-based Over-The-Air (IOTA) provisioning.

IOTA is used to provision various data elements such as Wireless Application Protocol (WAP) configuration parameters and roaming lists to the MC7095 over-the-air. It is also used to provision other elements such as applications and firmware.

6. Tap **ok** to exit settings.

Verizon Data Settings

Use the *Data* tab to reset connection settings for national access.

1. Tap **Start > Settings > Personal tab > Phone icon > Data Settings** tab.

or

Start > Phone > Menu > Options > Data Settings tab.

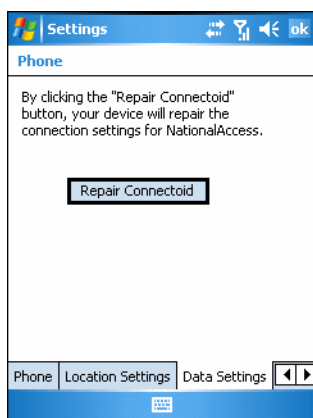

Figure 6-17 Phone Window - Verizon Data Tab

2. Tap **Reset Connection** to reset connection settings for National Access.
3. Tap **Yes**.
4. Tap **ok**.
5. Tap **ok** to exit settings.

Additional Service provider Data Settings

Use the *Data* tab to reset connection settings for the 3G connection.

1. Tap **Start > Settings > Personal tab > Phone icon > Data Settings** tab.

or

Start > Phone > Menu > Options > Data Settings tab.

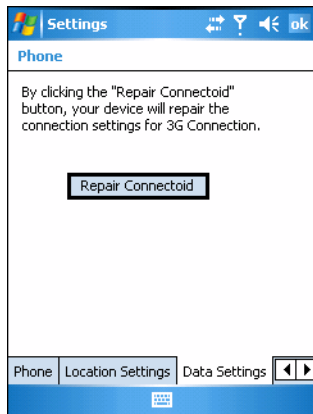

Figure 6-18 Phone Window - Data Tab

2. Tap **Reset Connection** to reset connection settings for the 3G connection.
3. Tap **Yes**.
4. Tap **ok**.
5. Tap **ok** to exit settings.

System Settings

Use the **System Settings** tab to select roaming options.

Tap **Start > Settings > Personal tab > Phone icon > System Settings** tab.

or

Start > Phone > Menu > Options > System tab.

Sprint System

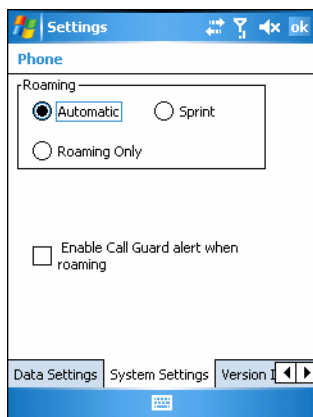

Sprint

Figure 6-19 Phone Window - System Settings Tab - Sprint

1. Roaming:

- Select the **Automatic** radio button to allow the phone to automatically seek a roaming network where the Sprint Nationwide PCS Network is not available. Automatic roaming is available where Sprint implemented roaming with other wireless carriers.
 - Select the **Sprint** radio button to allow the phone to automatically seek a roaming network within the Sprint Nationwide PCS Network only.
 - Select **Roaming Only** radio button to allow the phone to automatically seek a roaming network.
2. Select the **Enable Call Guard alert when roaming** check box to control roaming charges by receiving a reminder when a roaming call is made or received. When a roaming call is made or received, **Roaming rate applies for this call. Press OK to dial.** appears on the MC7095 display screen.
 3. Tap **ok** to exit settings.

Verizon System

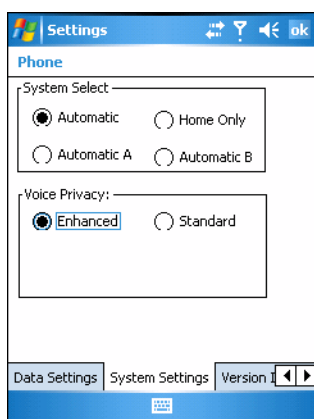

Figure 6-20 Phone Window - System Settings Tab - Verizon

1. System Select allows the user to change the system roaming preference of the radio in order to control the type of network the radio can lock onto for service.
 - Select the **Automatic** radio button to allow the radio to lock onto networks based on the provisioning of the radio.
 - Select the **Automatic A** or **Automatic B** radio button to allow the radio to lock onto an A or B network carrier, respectively, if no other network can be found that matches the radio's provisioning.
 - Select the **Home Only** radio button to prevent the radio from locking on any network that is considered a roaming network.
2. Voice Privacy allows the user to enable or disable voice privacy.
 - Select the **Enhanced** radio button to trigger the network to use voice privacy whenever the current network supports it. When in a call, if network privacy is being used, a voice privacy icon is displayed in the user interface.
 - Select the **Standard** radio button to prevent voice privacy from being used when in a call.
3. Tap **ok** to exit settings.

Additional Service Provider System

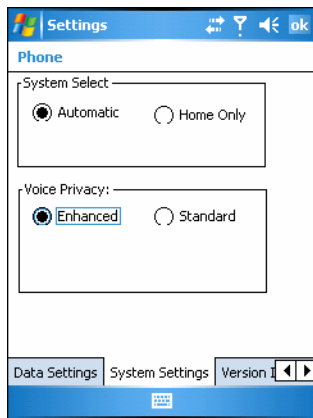

Figure 6-21 Phone Window - System Settings Tab - Additional

1. System Select allows the user to change the system roaming preference of the radio in order to control the type of network the radio can lock onto for service.
 - Select the **Automatic** radio button to allow the radio to lock onto networks based on the provisioning of the radio.
 - Select the **Home Only** radio button to prevent the radio from locking on any network that is considered a roaming network.
2. Voice Privacy allows the user to enable or disable voice privacy.
 - Select the **Enhanced** radio button to trigger the network to use voice privacy whenever the current network supports it. When in a call, if network privacy is being used, a voice privacy icon is displayed in the user interface.
 - Select the **Standard** radio button to prevent voice privacy from being used when in a call.
3. Tap **ok** to exit settings.

Version Information

Use the **Version Information** tab to view phone number and version information.

1. Tap **Start > Settings > Personal tab > Phone icon > Version Information tab.**

or

Start > Phone > Menu > Options > Version Information tab.

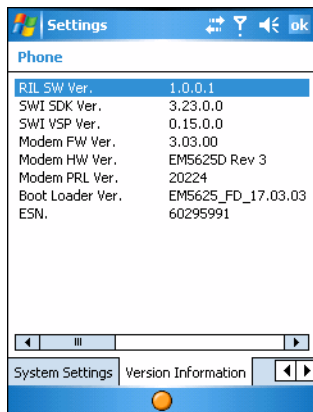

Figure 6-22 MC7095 Phone Window - Phone Info Tab

2. Tap **ok** to exit settings.

Services

Depending on the type of subscribed phone services, the following services may be available: call barring, caller ID, call forwarding, call waiting, voice mail and Short Message Service (SMS).

Call Barring (Call Blocking)

Call barring blocks certain types of incoming and/or outgoing calls. This service is setup when an account is opened with the service provider.

Caller ID

Caller ID provides a way for people to know the identity of the person making an outgoing call. To disable caller ID and block the outgoing phone number:

1. Enter *67 on the phone keypad.
2. Enter the phone number to call.



NOTE *67, followed by the phone number, must be entered on a call-by-call basis to block the outgoing phone number.

Call Forwarding

Use call forwarding to forward incoming calls to a different phone number. To enable call forwarding and send calls to another phone number:

1. Enter *72 (Sprint service) or *73 (Verizon service) on the phone keypad.
2. Enter the area code and phone number of the phone to accept the forwarded calls.
3. Tap **Talk**.
4. A beep sounds indicating activation.
5. Tap **End**.

To disable call forwarding:

1. Enter *720 on the phone keypad.
2. Tap **Talk**.
3. A beep sounds indicating deactivation.
4. Tap **End**.

Call Waiting

Call waiting notifies the user of an incoming call when the phone is in a phone session. This service is setup when an account is opened with the service provider.

Voice Mail and Short Message Service (SMS)

This service is setup when an account is opened with the service provider.

Chapter 7 Wireless Applications

Introduction



NOTE This chapter described Fusion versions below 2.55. For Fusion versions 2.55 and above, refer to the *Wireless Fusion Enterprise Mobility Suite User Guide for Version X2.XX User Guide* for information, where X.XX represents the Fusion version number. These guides are available on the Zebra Support Central web site: <http://www.zebra.com/support>.

Wireless Local Area Networks (LANs) allow mobile computers to communicate wirelessly and send captured data to a host device in real time. Before using the EDA on a WLAN, the facility must be set up with the required hardware to run the wireless LAN and the EDA must be configured. Refer to the documentation provided with the access points (APs) for instructions on setting up the hardware.

To configure the EDA, a set of wireless applications provide the tools to configure and test the wireless radio in the EDA. The *Wireless Application* menu on the task tray provides the following wireless applications:

- Wireless Status
- Wireless Diagnostics
- Find WLANs
- Manage Profiles
- Options
- Enable/Disable Radio
- Log On/Off.

Tap the **Signal Strength** icon to display the **Wireless Applications** menu.

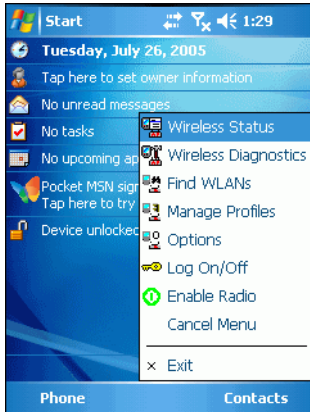

Figure 7-1 Wireless Applications Menu

Signal Strength Icon

The **Signal Strength** icon in the task tray indicates the EDA's wireless signal strength as follows:

Table 7-1 Wireless Applications Icons, Signal Strength Descriptions

Icon	Status	Action
	Excellent signal strength	Wireless LAN network is ready to use.
	Very good signal strength	Wireless LAN network is ready to use.
	Good signal strength	Wireless LAN network is ready to use.
	Fair signal strength	Wireless LAN network is ready to use. Notify the network administrator that the signal strength is only "Fair".
	Poor signal strength	Wireless LAN network is ready to use. Performance may not be optimum. Notify the network administrator that the signal strength is "Poor".
	Out-of-network range (not associated)	No wireless LAN network connection. Notify the network administrator.
	No wireless LAN network card detected	No wireless LAN network card detected or radio disabled. Notify the network administrator.

Turning the WLAN Radio On and Off

To turn the WLAN radio off tap the **Signal Strength** icon and select **Disable Radio**.

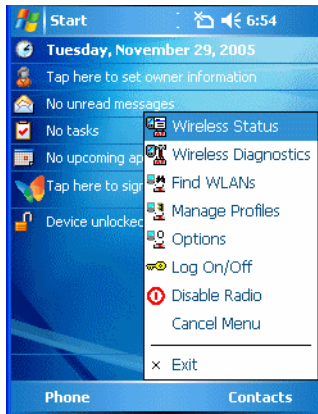

Figure 7-2 *Disable Radio*

To turn the WLAN radio on tap the **Signal Strength** icon and select **Enable Radio**.

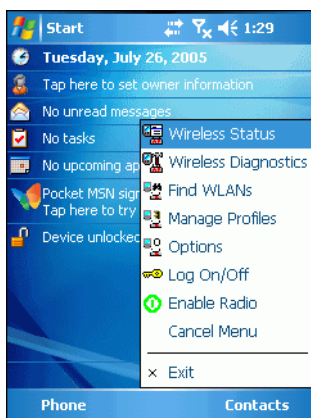

Figure 7-3 *Enable Radio*

Find WLANs Application

Use the **Find WLANs** application to discover available networks in the vicinity of the user and EDA. To open the **Find WLANs** application, tap the **Signal Strength** icon > **Find WLANs**. The **Find WLANs** window displays.

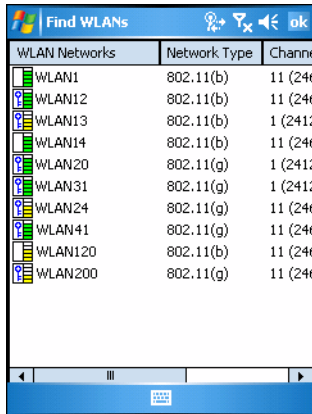

Figure 7-4 Find WLANs Window



NOTE The *Find WLANs* display is limited to 32 items (ESSIDs or MAC addresses). A combination of up to 32 ESSIDs/APs may be displayed.

Manually enter valid ESSIDs not displayed in the *Find WLANs* window. See [Figure 7-5 on page 7-5](#).

The *Find WLANs* list displays:

- WLAN Networks - Available wireless networks with icons that indicate signal strength and encryption type. The signal strength and encryption icons are described in [Table 7-2](#) and [Table 7-3](#).
- Network Type - Type of network.
- Channel - Channel on which the AP is transmitting.
- Signal Strength - The signal strength of the signal from the AP.

Table 7-2 Signal Strength Icon

Icon	Description
	Excellent signal
	Very good signal
	Good signal
	Fair signal
	Poor signal
	Out of range or no signal

Table 7-3 Encryption Icon

Icon	Description
	No encryption. WLAN is an infrastructure network.
	WLAN is an Ad-Hoc network.
	WLAN access is encrypted and requires a password.

Tap-and-hold on a WLAN network to open a pop-up menu which provides two options: **Connect** and **Refresh**. Select **Refresh** to refresh the WLAN list. Select **Connect** to create a wireless profile from that network. This starts the **Profile Editor Wizard** which allows you to set the values for the selected network. After editing the profile, the EDA automatically connects to this new profile.

Profile Editor Wizard

Use the **Profile Editor Wizard** to create a new profile or edit an existing profile. If editing a profile, the fields reflect the current settings for that profile. If creating a new profile, the known information for that WLAN network appears in the fields.

Navigate through the wizard using the **Next** and **Back** buttons. Tap **X** to quit. On the confirmation dialog box, tap **No** to return to the wizard or tap **Yes** to quit and return to the **Manage Profiles** window. See [Manage Profiles Application on page 7-21](#) for instructions on navigating the **Profile Editor Wizard**.

Profile ID

In the **Profile ID** dialog box in the **Profile Editor Wizard**, enter the profile name and the ESSID.

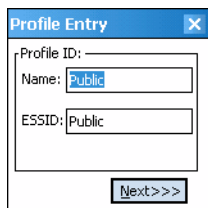

Figure 7-5 Profile ID Dialog Box

Table 7-4 Profile ID Fields

Field	Description
Name	The name and (WLAN) identifier of the network connection. Enter a user friendly name for the mobile computer profile used to connect to either an AP or another networked computer. Example: The Public LAN.
ESSID	The ESSID is the 802.11 extended service set identifier. The ESSID is 32-character (maximum) string identifying the WLAN, and must match the AP ESSID for the EDA to communicate with the AP.

✓ **NOTE** Two profiles with the same user friendly name are acceptable but not recommended.

Tap **Next**. The **Operating Mode** dialog box displays.

Operating Mode

Use the **Operating Mode** dialog box to select the operating mode (Infrastructure or Ad-Hoc) and the country location.

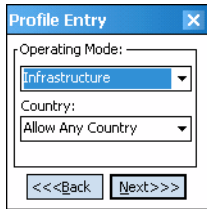

Figure 7-6 *Operating Mode Dialog Box*

Table 7-5 Operating Mode Fields

Field	Description
Operating Mode	<p>Select Infrastructure to enable the EDA to transmit and receive data with an AP. Infrastructure is the default mode.</p> <p>Select Ad Hoc to enable the EDA to form its own local network where mobile computers communicate peer-to-peer without APs using a shared ESSID.</p>
Country	<p>Country determines if the profile is valid for the country of operation. The profile country must match the country in the options page or it must match the acquired country if 802.11d is enabled.</p> <p>Single Country Use: When the device is only used in a single country, set every profile country to Allow Any Country. In the Options > Regulatory dialog box (see Figure 7-46 on page 7-35), select the specific country the device is used in, and deselect the <i>Enable 802.11d</i> option. This is the most common and efficient configuration, eliminating the initialization overhead associated with acquiring a country via 802.11d.</p> <p>Multiple Country Use: When the device is used in more than one country, select the Enable 802.11d option in the Options > Regulatory dialog box (see Figure 7-46 on page 7-35). This eliminates the need for reprogramming the country (in Options > Regulatory) each time you enter a new country. However, this only works if the infrastructure (i.e., APs) supports 802.11d (some infrastructures do not support 802.11d, including some Cisco APs). When the Enable 802.11d option is selected, the Options > Regulatory > Country setting is not used. For a single profile that can be used in multiple countries, with infrastructure that supports 802.11d (including Zebra infrastructure), set the Profile Country to Allow Any Country. Under Options > Regulatory, select Enable 802.11d. The Options > Regulatory > Country setting is not used.</p> <p>For a single profile that can be used in multiple countries, but with infrastructure that does not support 802.11d, set the profile country to Allow Any Country, and de-select (uncheck) Enable 802.11d. In this case, the Options > Regulatory > Country setting must always be set to the country the device is currently in. This configuration option is the most efficient and may be chosen for use with any infrastructure. However, the Options > Regulatory - Country setting must be manually changed when a new country is entered.</p> <p>Note that using a single profile in multiple countries implies that there is a common ESSID to connect to in each country. This is less likely than having unique ESSIDs in each country, this requires unique profiles for each country.</p> <p>For additional efficiency when using multiple profiles that can be used in multiple countries, the country setting for each profile can be set to a specific country. If the current country (found via 802.11d or set by Options > Regulatory > Country when 802.11d is disabled) does not match the country set in a given profile, then that profile is disabled. This can make profile roaming occur faster. For example, if two profiles are created and configured for Japan, and two more profiles are created and configured for USA, then when in Japan only the first two profiles are active, and when in USA only the last two are active. If they had all been configured for Allow Any Country, then all four would always be active, making profile roaming less efficient.</p>

Tap **Next**. If **Ad-Hoc** mode was selected the *Ad-Hoc* dialog box displays. If **Infrastructure** mode was selected the **Authentication** dialog box displays. See [Authentication on page 7-8](#) for instruction on setting up authentication.

Ad-Hoc

Use the **Ad-Hoc** dialog box to select the required information to control *Ad-Hoc* mode. This dialog box does not appear if you selected **Infrastructure** mode. To select Ad-Hoc mode:

1. Select a channel number from the **Channel** drop-down list.

Table 7-6 *Ad-Hoc Channels*

Band	Channel	Frequency
2.4 GHz	1	2412 MHz
	2	2417 MHz
	3	2422 MHz
	4	2427 MHz
	5	2432 MHz
	6	2437 MHz
	7	2442 MHz
	8	2447 MHz
	9	2452 MHz
	10	2457 MHz
	11	2462 MHz
5 GHz	36	5180 MHz
	40	5200 MHz
	44	5220 MHz
	48	5240 MHz

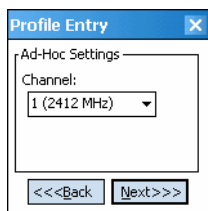

Figure 7-7 *Ad-Hoc Settings Dialog Box*

2. Tap **Next**. The **Authentication** dialog box displays.

Authentication

Use the **Authentication** dialog box to configure authentication. If you selected **Ad-Hoc** mode, this dialog box is not available and authentication is set to **None** by default.

Select an authentication type from the drop-down list and tap **Next**. Selecting **PEAP** or **TTLS** displays the **Tunneled** dialog box. Selecting **None**, **EAP TLS**, or **LEAP** displays the **Encryption** dialog box. See [Encryption on page 7-15](#) for encryption options. [Table 7-7](#) lists the available authentication options.

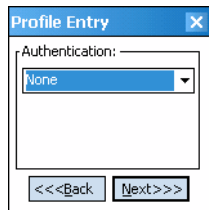

Figure 7-8 Authentication Dialog Box

Table 7-7 Authentication Options

Authentication	Description
None	Default setting when authentication is not required on the network.
EAP-TLS	Select this option to enable EAP-TLS authentication. EAP-TLS is an authentication scheme through IEEE 802.1x. It authenticates users and ensures only valid users can connect to the network. It also restricts unauthorized users from accessing transmitted information by using secure authentication certificates.
PEAP	Select this option to enable PEAP authentication. This method uses a digital certificate to verify and authenticate a user's identity.
LEAP	Select this option to enable LEAP authentication, which is based on mutual authentication. The AP and the connecting mobile computer require authentication before gaining access to the network.
TTLS	Select this option to enable TTLS authentication.

Tunneled Authentication

Use the **Tunneled Authentication** dialog box to select the tunneled authentication options. There are different selections available for PEAP or TTLS authentication.

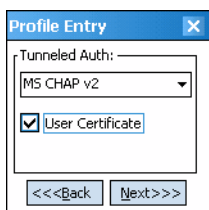

Figure 7-9 Tunneled Authentication Dialog Box

To select a tunneled authentication type:

1. Select a tunneled authentication type from the drop-down list. See [Table 7-8](#) and [Table 7-9](#).
2. Select the **User Certificate** check box if a certificate is required. If you selected the TLS tunnel type that requires a user certificate, the check box is already selected.
3. Tap **Next**. The **Installed User Certificates** dialog box appears.

[Table 7-8](#) lists the PEAP tunneled authentication options.

Table 7-8 PEAP Tunneled Authentication Options

PEAP Tunneled Authentication	Description
MS CHAP v2	Microsoft Challenge Handshake Authentication Protocol version 2 (MS CHAP v2) is a password-based, challenge-response, mutual authentication protocol that uses the industry-standard Message Digest 4 (MD4) and Data Encryption Standard (DES) algorithms to encrypt responses. The authenticating server challenges the access client and the access client challenges the authenticating server. If either challenge is not correctly answered, the connection is rejected. MS CHAP v2 was originally designed by Microsoft as a PPP authentication protocol to provide better protection for dial-up and virtual private network (VPN) connections. With Windows XP SP1, Windows XP SP2, Windows Server 2003, and Windows 2000 SP4, MS CHAP v2 is also an EAP type.
TLS	EAP TLS is used during phase 2 of the authentication process. This method uses a user certificate to authenticate.

[Table 7-9](#) lists the TTLS tunneled authentication options.

Table 7-9 TTLS Tunneled Authentication Options

TTLS Tunneled Authentication	Description
CHAP	Challenge Handshake Authentication Protocol (CHAP) is one of the two main authentication protocols used to verify the user name and password for PPP Internet connections. CHAP is more secure than PAP because it performs a three way handshake during the initial link establishment between the home and remote machines. It can also repeat the authentication anytime after the link is established.
MS CHAP	Microsoft Challenge Handshake Authentication Protocol (MS CHAP) is an implementation of the CHAP protocol that Microsoft created to authenticate remote Windows workstations. MS CHAP is identical to CHAP, except that MS CHAP is based on the encryption and hashing algorithms used by Windows networks, and the MS CHAP response to a challenge is in a format optimized for compatibility with Windows operating systems.
MS CHAP v2	MS CHAP v2 is a password based, challenge response, mutual authentication protocol that uses the industry standard Message Digest 4 (MD4) and Data Encryption Standard (DES) algorithms to encrypt responses. The authenticating server challenges the access client and the access client challenges the authenticating server. If either challenge is not correctly answered, the connection is rejected. MS CHAP v2 was originally designed by Microsoft as a PPP authentication protocol to provide better protection for dial-up and virtual private network (VPN) connections. With Windows XP SP1, Windows XP SP2, Windows Server 2003, and Windows 2000 SP4, MS CHAP v2 is also an EAP type.
PAP	Password Authentication Protocol (PAP) has two variations: PAP and CHAP PAP. It verifies a user name and password for PPP Internet connections, but it is not as secure as CHAP, since it works only to establish the initial link. PAP is also more vulnerable to attack because it sends authentication packets throughout the network. Nevertheless, PAP is more commonly used than CHAP to log in to a remote host like an Internet service provider.
MD5	Message Digest-5 (MD5) is an authentication algorithm developed by RSA. MD5 generates a 128-bit message digest using a 128-bit key, IPsec truncates the message digest to 96 bits.

User Certificate Selection

If you checked the **User Certificate** check box on the **Tunneled Authentication** dialog box or if **TLS** is the selected authentication type, the **Installed User Certificates** dialog box displays. Select a certificate from the drop-down list of currently installed certificates before proceeding. The selected certificate's name appears in the drop-down list. If the required certificate is not in the list, install it.

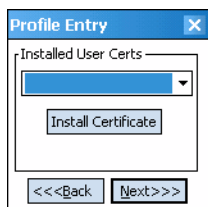

Figure 7-10 Installed User Certificates Dialog Box

User Certificate Installation

To install a user certificate (EAP TLS only) and a server certificate for EAP TLS and PEAP authentication:

1. Tap **Install Certificate**. The **Credentials** dialog box appears.

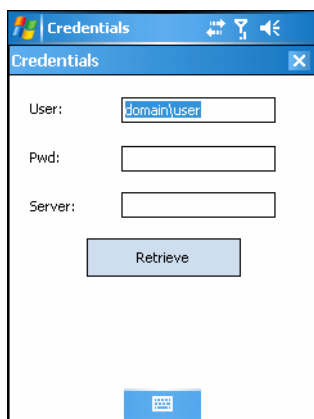

Figure 7-11 Credentials Dialog Box

2. Enter the **User:**, **Pwd:** (password), and **Server:** information in their respective text boxes.
3. Tap **Retrieve**. A **Progress** dialog indicates the status of the certificate retrieval.
4. Tap **ok** to exit.

After the installation completes, the **Installed User Certs** dialog box displays and the certificate is available in the drop-down box for selection.



NOTE To successfully install a user certificate, the EDA must already be connected to a network from which the server is accessible.

Server Certificate Selection

If you select the **Validate Server Certificate** check box, a server certificate is required. Select a certificate on the **Installed Server Certificates** dialog box. An hour glass may appear as the wizard populates the existing certificate list. If the required certificate is not listed, install it:

1. Tap the **Install Certificate** button.

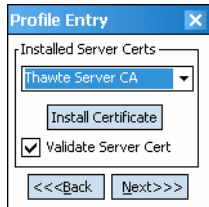

Figure 7-12 *Installed Server Certificates Dialog Box*

A dialog box appears that lists the currently loaded certificate files found in the default directory with the default extension.

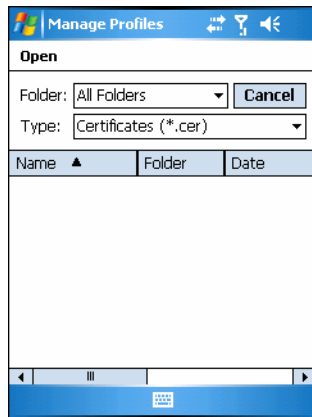

Figure 7-13 *Browse Server Certificates*

Press the **ENT** key to change the default path or extension (and search a new path). Select a certificate before tapping the **Install** button.

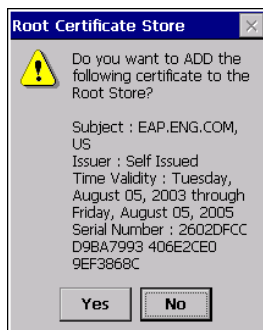

Figure 7-14 *Confirmation Dialog Box*

A confirmation dialog verifies the installation. If the information in this dialog is correct, tap the **Yes** button, If the information in this dialog is not correct tap the **No** button. The wizard returns to the **Installed Server Certs** dialog box.

Credential Cache Options

If you selected any of the password-based authentication types, you can select different credential caching options. These options specify when the network credential prompts appear: at connection, on each resume, or at a specified time.

Entering the credentials directly into the profile permanently caches the credentials. In this case, the EDA does not require user login. If a profile does not contain credentials entered through the configuration editor, you must log in to the EDA before connecting.

Caching options only apply on credentials entered through the login dialog box.

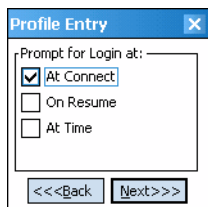

Figure 7-15 Prompt for Login at Dialog Box

If the EDA does not have the credentials, you are prompted to enter a username and password. If the EDA has the credentials (previous entered via a login dialog box), it uses these credentials unless the caching options require the EDA to prompt for new credentials. If you entered the credentials via the profile, the EDA does not prompt for new credentials. [Table 7-10](#) lists the caching options.

Table 7-10 Cache Options

	Description
At Connect	Select this option to prompt for credentials whenever the WCS tries to connect to a new profile. Deselect this to use the cached credentials to authenticate. If the credentials are not cached, you are prompted to enter credentials. This option only applies when logged in.
On Resume	Selecting this reauthenticates an authenticated user when a suspend/resume occurs. Once reauthenticated, the user is prompted for credentials. If the user does not enter the same credentials that were entered prior to the suspend/resume within three attempts, the user is disconnected from the network. This option only applies when logged in.
At Time	Select this option to perform a local verification on an authenticated user at a specified time. The time can be an absolute time or a relative time from the authentication, and should be in at least 5 minute intervals. Once the time has passed, the user is prompted for credentials. If the user does not enter the correct credentials within three attempts, the user is disconnected from the network. This option only applies when logged in.

Entering credentials applies these credentials to a particular profile. Logging out clears all cached credentials. Editing a profile clears all cached credentials for that profile.

The following authentication types have credential caching:

- EAP TLS
- PEAP
- LEAP
- TTLS.

Selecting the **At Time** check box displays the **Time Cache Options** dialog box.

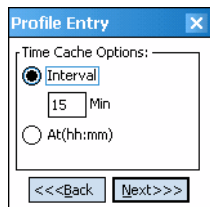

Figure 7-16 Time Cache Options Dialog Box

1. Tap the **Interval** radio button to check credentials at a set time interval.
2. Enter the value in minutes in the **Min** box.
3. Tap the **At (hh:mm)** radio button to check credentials at a set time.
4. Tap **Next**. The **At Time** dialog box appears.

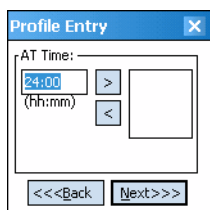

Figure 7-17 At Time Dialog Box

5. Enter the time using the 24 hour clock format in the **(hh:mm)** box.
6. Tap **>** to move the time to the right. Repeat for additional time periods.
7. Tap **Next**. The **User Name** dialog box displays.

User Name

The user name and password can be entered (but is not required) when the profile is created. When a profile authenticates with credentials that were entered in the profile, caching rules do not apply. Caching rules only apply on credentials that are entered through the login dialog box.

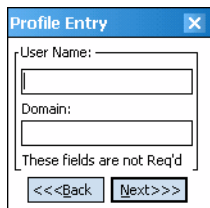

Figure 7-18 Username Dialog Box

Password

Use the **Password** dialog box to enter a password. If EAP/TLS is the selected authentication type, the password is not required and the field is disabled.



Figure 7-19 Password Dialog Box

1. Enter a password in the **Password** field.
2. Select the **Advanced ID** check box, if advanced identification is required.
3. Tap **Next**. The **Encryption** dialog box displays. See [Encryption on page 7-15](#).

Advanced Identity

Use the **Advanced ID** dialog box to enter the 802.1X identity to supply to the authenticator. This value can be 63 characters long and is case sensitive. In TTLS and PEAP, it is recommended entering the identity **anonymous** (rather than a true identity) plus any desired realm (e.g., anonymous@myrealm). A user ID is required before proceeding.

✓ **NOTE** When authenticating with a Microsoft IAS server, do not use advanced identity.

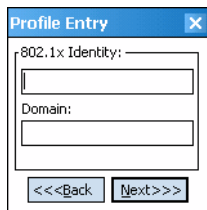

Figure 7-20 Advanced Identity Dialog Box

Tap **Next**. The **Encryption** dialog box displays.

Encryption

Use the **Encryption** dialog box to select an encryption type. The drop-down list includes encryption types available for the selected authentication type. See [Table 7-12](#) for these encryption types.

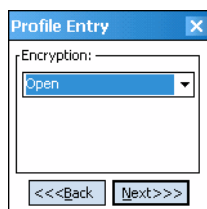

Figure 7-21 Encryption Dialog Box

Table 7-11 Encryption Options

Encryption	Description
Open	Select Open (the default) when no data packet encryption is needed over the network. Selecting this option provides no security for data transmitting over the network.
40-Bit WEP	<p>Select 40-Bit WEP to use 40-bit key length WEP encryption. WEP keys are manually entered in the edit boxes. Only the required number of edit boxes for a key length is displayed (10 Hex digit value for 40-bit keys). Use the Key Index drop-down list to configure the four WEP keys. The adapter uses the selected key. Note: The default Hex digit keys are visible any time they are used. As a security precaution after setting the key values for the network, the digits are replaced with asterisks * in the encryption key fields.</p> <p>If the associated AP uses an optional passkey, the active adapter WLAN profile must use one as well. The passkey is a plain text representation of the WEP keys displayed in the encryption dialog box. The passkey provides an easy way to enter WEP key data without having to remember the entire 40-bit (10 character) Hex digit string.</p>
128-Bit WEP	<p>Select 128-Bit WEP to use 128-bit key length WEP encryption. WEP keys are manually entered in the edit boxes. Only the required number of edit boxes for a key length is displayed (26 Hex digit value for 128-bit keys). Use the Key Index drop-down list to configure the four WEP keys. The adapter uses the selected key. Note: The default Hex digit keys are visible any time they are used. As a security precaution after setting the key values for the network, the digits are replaced with asterisks * in the encryption key fields.</p> <p>If the associated AP uses an optional passkey, the active adapter WLAN profile must use one as well. The passkey is a plain text representation of the WEP keys displayed in the encryption dialog box. The passkey provides an easy way to enter WEP key data without having to remember the entire 128-bit (26 character) Hex digit string.</p>
TKIP	Select this option to use Wireless Protected Access (WPA) via TKIP. Manually enter the shared keys in the passkey field. Tap Next to display the passkey dialog box. Enter an 8 to 63 character string.
AES (Fusion 2.5 only)	Select this option to use Advanced Encryption Standard (AES). Manually enter the shared keys in the passkey field. Tap Next to display the passkey dialog box. Enter an 8 to 63 character string.

Table 7-12 Encryption / Authentication Matrix

Authentication	Encryption			
	Open	WEP	TKIP	AES (Fusion 2.5 only)
None	Yes	Yes	Yes	Yes
EAP TLS	No	Yes	Yes	Yes
PEAP	No	Yes	Yes	Yes
LEAP	No	Yes	Yes	Yes
TTLS	No	Yes	Yes	Yes

Key Entry Page

If you select either **40-Bit WEP** or **128-Bit WEP** the wizard proceeds to the key entry dialog box unless the **Use Passkey** check box was selected in the **Encryption** dialog box (see [Figure 7-21 on page 7-15](#)). The **Key Entry** dialog box will be shown only if the authentication is set to **None**. To enter the key information:

1. Enter the 40-bit or 128-bit keys into the fields.
2. Tap **Next**.

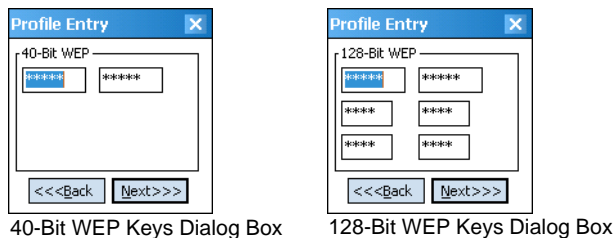

Figure 7-22 40-Bit and 128-Bit WEP Keys Dialog Boxes

Passkey Dialog

When you select **None** as an authentication and **WEP** as an encryption, you can choose to enter a passkey by checking the **Use PassKey** check box. The user is prompted to enter the passkey. For WEP, the **Use PassKey** checkbox is only available if the authentication is *None*.

When you select *None* as an authentication and **TKIP** as an encryption, you must enter a passkey. The user cannot enter a passkey if the encryption is **TKIP** and the authentication is anything other than **None**.

When you select **None** as an authentication and **AES** as an encryption, you must enter a passkey. The user cannot enter a passkey if the encryption is **AES** and the authentication is anything other than **None**.

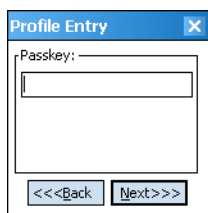

Figure 7-23 Passkey Dialog Box

Tap **Next**. The **IP Mode** dialog box displays.

IP Mode

Use the **IP Mode** dialog box to configure network address parameters: IP address, subnet, gateway, DNS, and WINS.

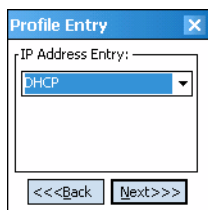

Figure 7-24 IP Config Tab (DHCP)

Table 7-13 IP Mode Options

Encryption	Description
DHCP	Select Dynamic Host Configuration Protocol (DHCP) from the IP Mode drop-down list to obtain a leased IP address and network configuration information from a remote server. DHCP is the default setting for the EDA profile. When DHCP is selected, the IP address fields are read-only.
Static	Select Static to manually assign the IP, subnet mask, default gateway, DNS, and WINS addresses the EDA profile uses.

Select either **DHCP** or **Static** from the drop-down list and tap **Next**. Selecting **Static IP** displays the **IP Address Entry** dialog box. Selecting **DHCP** displays the **Transmit Power** dialog box.

IP Address Entry

Use the **IP Address Entry** dialog box to enter the IP address and subnet information.

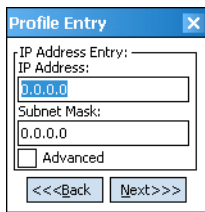
**Figure 7-25** Static IP Address Entry Dialog Box**Table 7-14** Static IP Address Entry Fields

Field	Description
IP Address	The Internet is a collection of networks with users that communicate with each other. Each communication carries the address of the source and destination networks and the particular machine within the network associated with the user or host computer at each end. This address is called the IP address (Internet Protocol address). Each node on the IP network must be assigned a unique IP address that is made up of a network identifier and a host identifier. Enter the IP address as a dotted-decimal notation with the decimal value of each octet separated by a period, for example, 192.168.7.27.
Subnet Mask	Most TCP/IP networks use subnets to manage routed IP addresses. Dividing an organization's network into subnets allows it to connect to the Internet with a single shared network address, for example, 255.255.255.0.

Select the **Advanced** check box, then tap **NEXT** to display the **Advanced Address Entry** dialog box. Enter the Gateway, DNS, and WINS address. Tap **NEXT** without selecting the **Advanced** check box to display the **Transmit Power** dialog box.

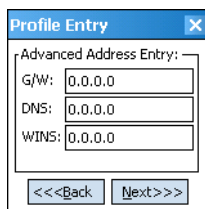
**Figure 7-26** Advanced Address Entry Dialog Box

The IP information entered in the profile is only used if you selected the **Enable IP Mgmt** check box in the **Options > System Options** dialog box ([System Options on page 7-35](#)). If you didn't select this, the IP information in the profile is ignored and the IP information entered in the Microsoft interface applies.

Table 7-15 IP Config Advanced Address Entry Fields

Field	Description
G/W	The default gateway forwards IP packets to and from a remote destination.
DNS	The Domain Name System (DNS) is a distributed Internet directory service. DNS translates domain names and IP addresses, and controls Internet email delivery. Most Internet services require DNS to operate properly. If DNS is not configured, Web sites cannot be located and/or email delivery fails.
WINS	WINS is a Microsoft® Net BIOS name server. WINS eliminates the broadcasts needed to resolve computer names to IP addresses by providing a cache or database of translations.

Tap **Next**. The **Transmit Power** dialog box displays.

Transmit Power

The **Transmit Power** drop-down list contains different options for Ad-Hoc and Infrastructure mode. Automatic (i.e., use the current AP settings) and Power Plus (use higher than the current AP settings) are available for **Infrastructure** mode.

Adjusting the radio transmission power level enables the user to expand or confine the transmission area with respect to other wireless devices that could be operating nearby. Reducing coverage in high traffic areas improves transmission quality by reducing the amount of interference in that coverage area.

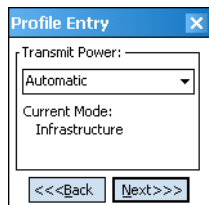

Figure 7-27 Transmit Power Dialog Box (Infrastructure Mode)

Table 7-16 Transmit Power Dialog Box (Infrastructure Mode)

Field	Description
Automatic	Select Automatic (the default) to use the AP power level.
Power Plus	Select Power Plus to set the EDA transmission power one level higher than the level set for the AP.

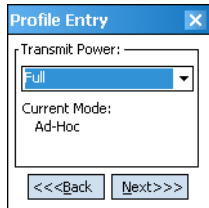

Figure 7-28 Transmit Power Dialog Box (Ad-Hoc Mode)

Table 7-17 Power Transmit Options (Ad-Hoc Mode)

Field	Description
Full	Select Full power for the highest transmission power level. Select Full power when operating in highly reflective environments and areas where other devices could be operating nearby, or when attempting to communicate with devices at the outer edge of a coverage area.
30 mW	Select 30 mW to set the transmit power level to 30 mW.
15 mW	Select 15 mW to set the transmit power level to 15 mW.
5 mW	Select 5 mW to set the transmit power level to 5 mW.
1 mW	Select 1 mW for the lowest transmission power level. Use this level when communicating with other devices in very close proximity, or in instances where you expect little or no radio interference from other devices.

Tap **Next** to display the **Battery Usage** dialog box.

Battery Usage

Use the **Battery Usage** dialog box to select power consumption of the wireless LAN. There are three settings available: CAM, Fast Power Save, and MAX Power Save. Battery usage cannot be configured in Ad-Hoc profiles.

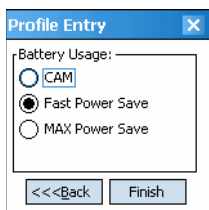

Figure 7-29 Battery Usage Dialog Box



NOTE Power consumption is also related to the transmit power settings.

Table 7-18 Battery Usage Options

Field	Description
CAM	Continuous Aware Mode (CAM) provides the best network performance, but yields the shortest battery life.
Fast Power Save	Fast Power Save (the default) performs in the middle of CAM and MAX Power Save with respect to network performance and battery life.
MAX Power Save	Max Power Save yields the longest battery life while potentially reducing network performance. In networks with minimal latency, Max Power Save performs as well as Fast Power Save, but with increased battery conservation.

Manage Profiles Application

The **Manage Profiles** window provides a list of user-configured wireless profiles. Define up to 32 profiles at any one time. To open the **Manage Profiles** window, tap the **Signal Strength** icon > **Manage Profiles**.

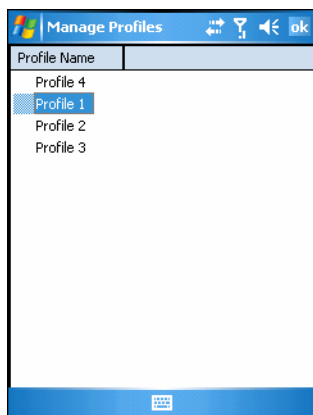
**Figure 7-30** Manage Profiles Window

Icons next to each profile identify the profile's current state.

Table 7-19 Profile Icons







Icon	Description
No Icon	Profile is not selected, but enabled.
	Profile is disabled.
	Profile is cancelled. A cancelled profile is disabled until a connect or login function is performed through the configuration editor.
	Profile is in use and describes an infrastructure profile not using encryption.
	Profile is in use and describes an infrastructure profile using encryption.

Table 7-19 Profile Icons (Continued)

Icon	Description
	Profile is in use and describes an ad-hoc profile not using encryption.
	Profile is in use and describes an ad-hoc profile using encryption.
	Profile is not valid in the device current operating regulatory domain.

The profiles are listed in priority order for use by the automatic roaming feature. Change the order by moving profiles up or down. To edit existing profiles, tap and hold one in the list and select an option from the menu to connect, edit, disable (enable), or delete the profile. (Note that the **Disable** menu item changes to **Enable** if the profile is already disabled.)

**Figure 7-31** Manage Profiles Context Menu

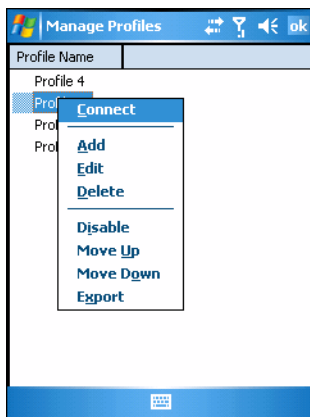
Changing Profiles

A completed profile is a set of configuration settings that can be used in different locations to connect to a wireless network. Create different profiles to have pre-defined operating parameters available for use in various network environments. When the **WLAN Profiles** window displays, existing profiles appear in the list.

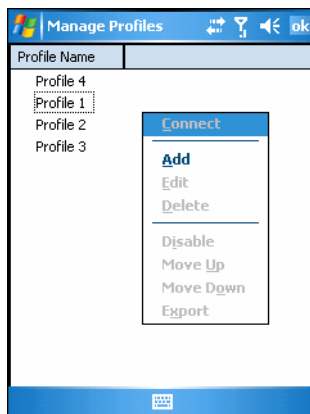
**Figure 7-32** Manage Profiles

Tap and hold a profile and select **Connect** from the pop-up menu to set this as the active profile. Once selected, the EDA uses the authentication, encryption, ESSID, IP Config, and power consumption settings configured for that profile.

Editing a Profile

Tap and hold a profile and select **Edit** from the pop-up menu to display the **Profile Wizard** where you can set the ESSID and operating mode for the profile. Use the **Profile Wizard** to edit the profile power consumption and security parameters. See [Profile Editor Wizard on page 7-5](#).

Creating a New Profile

To create new profiles from the **Manage Profiles** window, tap-and-hold anywhere in this window.

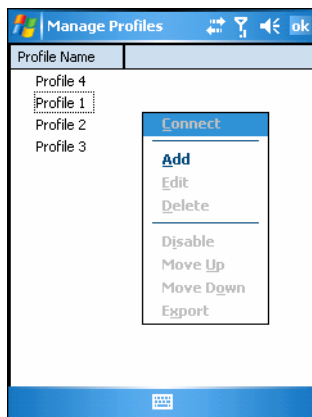

Figure 7-33 *Manage Profiles - Add*

Select **Add** to display the **Profile Wizard** wherein you can set the profile name and ESSID. Set security, network address information, and power consumption level for the new profile.

Deleting a Profile

To delete a profile from the list, tap and hold and select **Delete** from the pop-up menu. A confirmation dialog box appears.

Ordering Profiles

Tap and hold a profile from the list and select **Move Up** or **Move Down** to order the profile. If the current profile association is lost, the EDA attempts to associate with the first profile in the list, then the next, until it achieves a new association.

✓ **NOTE** Profile Roaming must be enabled.

Export a Profile

To export a profile to a registry file, tap and hold a profile from the list and select **Export** from the pop-up menu. The **Save As** dialog box displays with the **Application** folder and a default name of `WCS_PROFILE{profile GUID}.reg` (Globally Unique Identifier).

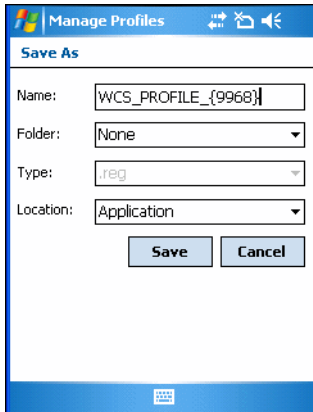

Figure 7-34 *Save As Dialog Box*

If required, change the name in the **Name** field and tap **Save**. A confirmation dialog box appears after the export completes.

Wireless Status Application

To open the **Wireless Status** window, tap the **Signal Strength** icon > **Wireless Status**. The **Wireless Status** window displays information about the wireless connection.

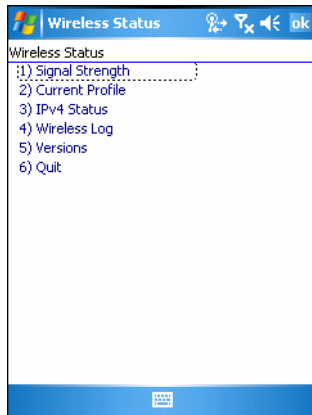

Figure 7-35 *Wireless Status Window*

The **Wireless Status** window contains the following options. Tap the option to display the option window.

- **Signal Strength** - provides information about the connection status of the current wireless profile.
- **Current Profile** - displays basic information about the current profile and connection settings.
- **IPv4 Status** - displays the current IP address, subnet, and other IP related information assigned to the EDA.
- **Wireless Log** - displays a log of important recent activity, such as authentication, association, and DHCP renewal completion, in time order.
- **Versions** - displays software, firmware, and hardware version numbers.
- **Quit** - exits the **Wireless Status** window.

Option windows contain a back button  to return to the main **Wireless Status** window.

Signal Strength Window

The **Signal Strength** window provides information about the connection status of the current wireless profile including signal quality, missed beacons, and transmit retry statistics. The BSSID address (shown as *AP MAC Address*) displays the AP currently associated with the connection. In Ad-Hoc mode, the AP MAC Address shows the BSSID of the Ad-Hoc network. Information in this window updates every 2 seconds.

To open the **Signal Status** window, tap **Signal Strength** in the **Wireless Status** window.

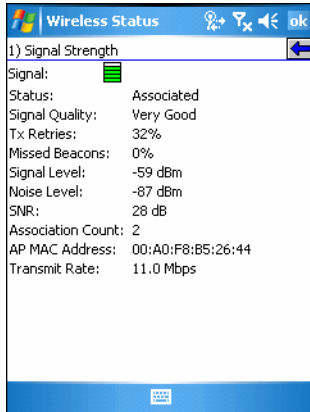









Figure 7-36 Signal Strength Window

After viewing the **Signal Strength** window, tap the back button to return to the **Wireless Status** window.

Table 7-20 Signal Strength Status

Field	Description
Signal	<p>Displays the Relative Signal Strength Indicator (RSSI) of the signal transmitted between the AP and EDA. As long as the Signal Quality icon is green the AP association is not jeopardized. If the icon is red (poor signal), an association with a different AP could be warranted to improve the signal. The signal strength icon changes depending on the signal strength.</p> <ul style="list-style-type: none">  Excellent Signal  Very Good Signal  Good Signal  Fair Signal  Poor Signal  Out of Range (no signal)  The radio card is off or there is a problem communicating with the radio card.
Status	Indicates if the EDA is associated with the AP.
Signal Quality	Displays a text format of the Signal icon.
Tx Retries	Displays a percentage of the number of data packets the EDA retransmits. The fewer transmit retries, the more efficient the wireless network is.
Missed Beacons	Displays a percentage of the amount of beacons the EDA missed. The fewer transmit retries, the more efficient the wireless network is. Beacons are uniform system packets broadcast by the AP to keep the network synchronized.
Signal Level	The AP signal level in decibels per milliwatt (dBm).
Noise Level	The background interference (noise) level in decibels per milliwatt (dBm).
SNR	The access point/EDA Signal to Noise Ratio (SNR) of signal strength to noise (interference) in decibels per milliwatt (dBm).
Association Count	Displays the number of APs the EDA connects to while roaming.
AP MAC Address	Displays the MAC address of the AP to which the EDA is connected.
Transmit Rate	Displays the current rate of the data transmission.

Current Profile Window

The **Current Profile** window displays basic information about the current profile and connection settings. This window updates every two seconds.

To open the **Current Profile** window, tap **Current Profile** in the **Wireless Status** window.

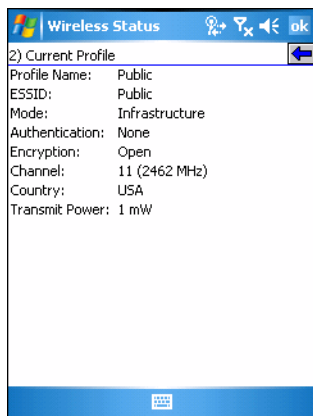

Figure 7-37 Current Profile Window

Table 7-21 Current Profile Window

Field	Description
Profile Name	Displays the current profile name the EDA uses to communicate with the AP.
ESSID	Displays the current profile ESSID name.
Mode	Displays the current profile mode, either Infrastructure or Ad-Hoc.
Authentication	Displays the current profile's authentication type.
Encryption	Displays the current profile's encryption type.
Channel	Displays the current profile's channel setting.
Country	Displays the current profile's country setting.
Transmit Power	Displays the radio transmission power level.

IPv4 Status Window

The **IPv4 Status** window displays the current IP address, subnet, and other IP related information assigned to the EDA. It also allows renewing the address if the profile is using DHCP to obtain the IP information. Tap **Renew** to initiate a full DHCP discover. The **IPv4 Status** window updates automatically when the IP address changes.

To open the **IPv4 Status** window, tap **IPv4 Status** in the **Wireless Status** window.

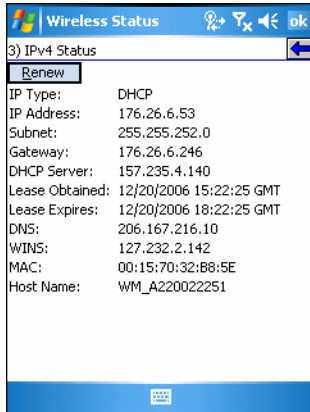

Figure 7-38 IPv4 Status Window

Table 7-22 IPv4 Status Fields

Field	Description
IP Type	Displays the IP type for the current profile: DHCP or Static . If the IP type is DHCP, leased IP address and network address data appear for the EDA. If the IP type is Static, the values displayed were input manually, see <i>IP Mode on page 7-17</i> .
IP Address	Displays the EDA's IP address. The Internet is a collection of networks with users that communicate with each other. Each communication carries the address of the source and destination networks and the particular machine within the network associated with the user or host computer at each end. This address is called the IP address. Each node on the IP network must be assigned a unique IP address that is made up of a network identifier and a host identifier. The IP address as a dotted-decimal notation with the decimal value of each octet separated by a period, for example, 192.168.7.27.
Subnet	Displays the subnet address. Most TCP/IP networks use subnets to manage routed IP addresses. Dividing an organization's network into subnets allows it to connect to the Internet with a single shared network address, for example, 255.255.255.0.
Gateway	Displays the gateway address. A gateway forwards IP packets to and from a remote destination.
DCHP Server	The Domain Name System (DNS) is a distributed Internet directory service. DNS translates domain names and IP addresses, and controls Internet e-mail delivery. Most Internet services require DNS to operate properly. If DNS is not configured, Web sites cannot be located or e-mail delivery fails.
Lease Obtained	Displays the date that the IP address was obtained.
Lease Expires	Displays the date that the IP address expires and a new IP address is requested.
DNS	Displays the IP address of the DNS server.
WINS	WINS is a Microsoft Net BIOS name server. WINS eliminates the broadcasts needed to resolve computer names to IP addresses by providing a cache or database of translations.
MAC	An IEEE 48-bit address is assigned to the EDA at the factory to uniquely identify the adapter at the physical layer.
Host Name	Displays the name of the EDA.

Wireless Log Window

The **Wireless Log** window displays a log of recent activity, such as authentication, association, and DHCP renewal completion, in time order. Save the log to a file or clear the log (within this instance of the application only). The auto-scroll feature automatically scrolls down when new items are added to the log.

To open the **Wireless Log** window, tap **Wireless Log** in the **Wireless Status** window. The **Wireless Log** window displays.

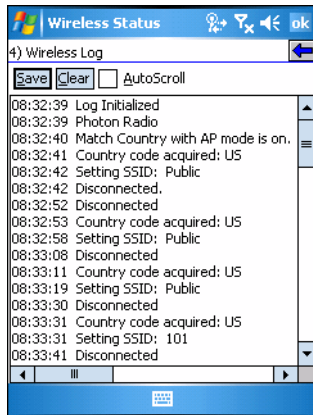

Figure 7-39 Wireless Log Window

Saving a Log

To save a Wireless Log:

1. Tap the **Save** button. The **Save As** dialog box displays.
2. Navigate to the desired folder.
3. In the **Name** field, enter a file name and then tap **OK**. A text file is saved in the selected folder.

Clearing the Log

To clear the log, tap **Clear**.

Versions Window

The **Versions** window displays software, firmware, and hardware version numbers. This window only updates when it is displayed. There is no need to update constantly. The content of the window is determined at runtime, along with the actual hardware and software to display in the list. Executable paths of the software components on the list are defined in registry, so that the application can retrieve version information from the executable. "File not found" appears if the executable cannot be found at the specified path.

To open the **Versions** window, tap **Versions** in the **Wireless Status** window.

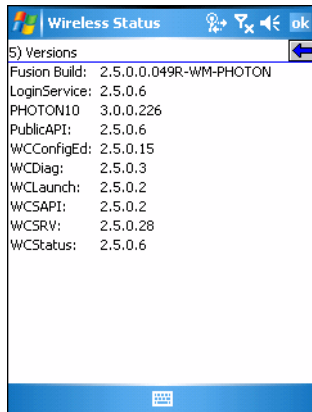

Figure 7-40 *Versions Window*

The window displays software version numbers for the following:

- Configuration Editor (Fusion 2.4 and lower only)
- Fusion Build
- LoginService
- PHOTON10
- PublicAPI (Fusion 2.5 and higher only)
- WCDiag
- WCLaunch
- WCSAPI
- WCSRV
- WCStatus.

Wireless Diagnostics Application

The **Wireless Diagnostics** application window provides links to perform ICMP Ping, Trace Routing, and Known APs. To open the **Wireless Diagnostics** window, tap the **Signal Strength** icon > **Wireless Diagnostics**.

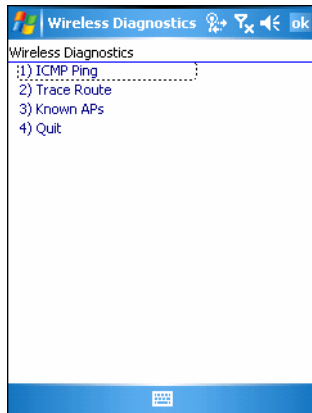

Figure 7-41 *Wireless Diagnostics Window*

The **Wireless Diagnostics** window contains the following options. Tap the option to display the option window.

- ICMP Ping - tests the wireless network connection.
- Trace Route - tests a connection at the network layer between the EDA and any place on the network.
- Known APs - displays the APs in range using the same ESSID as the EDA.
- Quit - Exits the **Wireless Diagnostics** window.

Option windows contain a back button  to return to the **Wireless Diagnostics** window.

ICMP Ping Window

The **ICMP Ping** window allows testing a connection at the network layer (part of the IP protocol) between the EDA and an AP. Ping tests only stop when you tap the **Stop Test** button, close the **Wireless Diagnostics** application, or if the EDA switches between infrastructure and ad-hoc modes.

To open the **ICMP Ping** window, tap the **ICMP Ping** in the **Wireless Diagnostics** window.

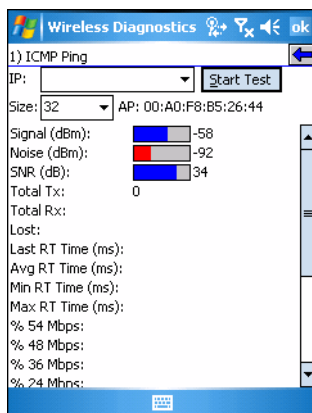

Figure 7-42 *ICMP Ping Window*

To perform an ICMP ping:

1. In the **IP** field, enter an IP address or select an IP address from the drop-down list.
2. From the **Size** drop-down list, select a size value.
3. Tap **Start Test**. The ICMP Ping test starts. Information of the ping test displays in the appropriate fields.

Trace Route Window

Trace Route traces a packet from a computer to a host, showing how many hops the packet requires to reach the host and how long each hop takes. The **Trace Route** utility identifies where the longest delays occur.

The **Trace Route** window allows testing a connection at the network layer (part of the IP protocol) between the EDA and any place on the network.

To open the **Trace Route** window, tap **Trace Route** in the **Wireless Diagnostics** window.



Figure 7-43 Trace Route Window

Enter an IP address or a DNS Name in the IP combo box, and tap **Start Test**. The IP combo box should match the information shown in the **ICMP Ping** window's IP combo box. When starting a test, the trace route attempts to find all routers between the EDA and the destination. The Round Trip Time (RTT) between the EDA and each router appears, along with the total test time. The total test time may be longer than all RTTs added together because it does not only include time on the network.

Known APs Window

The **Known APs** window displays the APs in range using the same ESSID as the EDA. This window is only available in **Infrastructure** mode. To open the **Known APs** window, tap **Known APs** in the **Wireless Diagnostics** window.

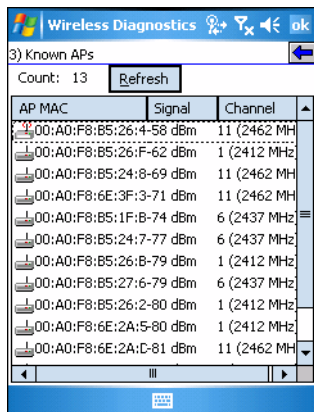

Figure 7-44 Known APs Window

See [Table 7-23](#) for the definitions of the icons next to the AP.

Table 7-23 Current Profile Window

Icon	Description
	The AP is the associated access point, and is set to mandatory.
	The AP is the associated access point, but is not set to mandatory.
	The EDA is not associated to this AP, but the AP is set as mandatory.
	The EDA is not associated to this AP, and AP is not set as mandatory.

Tap and hold on an AP to display a pop-up menu with the following options: **Set Mandatory** and **Set Roaming**.

Select **Set Mandatory** to prohibit the EDA from associating with a different AP. The letter **M** displays on top of the icon. The EDA connects to the selected AP and never roams until:

- You select **Set Roaming**
- The EDA roams to a new profile
- The EDA suspends
- The EDA resets (warm or cold).

Select **Set Roaming** to allow the EDA to roam to any AP with a better signal. These settings are temporary and never saved to the registry.

Tap **Refresh** to update the list of the APs with the same ESSID. The highest signal strength value is 32.

Options

Use the wireless **Option** dialog box to select one of the following operation options from the drop-down list:

- Operating Mode Filtering
- Regulatory
- Band Selection
- System Options

- Change Password
- Export.

Operating Mode Filtering

The **Operating Mode Filtering** options cause the Find WLANs application to filter the available networks found.

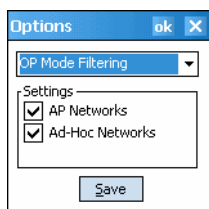

Figure 7-45 OP Mode Filtering Dialog Box

The **AP Networks** and **Ad-Hoc Networks** check boxes are selected by default.

Table 7-24 OP Mode Filtering Options

Field	Description
AP Networks	Select the AP Networks check box to display available AP networks and their signal strength within the Available WLAN Networks (see Find WLANs Application on page 7-3). These are the APs available to the EDA profile for association. If this option was previously disabled, refresh the Available WLAN Networks window to display the AP networks available to the EDA.
AD-Hoc Networks	Select the Ad-Hoc Networks check box to display available peer (adapter) networks and their signal strength within the Available WLAN Networks . These are peer networks available to the EDA profile for association. If this option was previously disabled, refresh the Available WLAN Networks window to display the Ad Hoc networks available to the EDA.

Tap **Save** to save the settings or tap **X** to discard any changes.

Regulatory Options

Use the **Regulatory** settings to configure the country the EDA is in. Due to regulatory requirements (within a country) a EDA is only allowed to use certain channels.

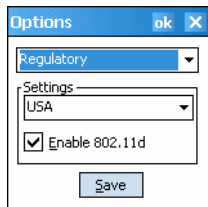

Figure 7-46 Regulatory Options Dialog Box

Table 7-25 Regulatory Options

Field	Description
Settings	Select the country from the drop-down list. To connect to a profile, the profile country must match this setting, or the AP country setting if you selected the Enable 802.11d check box.
Enable 802.11d	The WLAN adapter attempts to retrieve the country from APs. Profiles which use Infrastructure mode can only connect if the country set is the same as the AP country settings or if the profile country setting is Allow Any Country . All APs must be configured to transmit the country information.

Band Selection

The **Band Selection** settings identify the frequency bands to scan when finding WLANs. These values refer to the 802.11 standard networks.

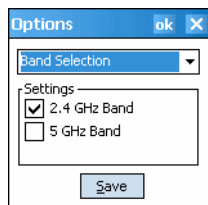

Figure 7-47 Band Selection Dialog Box

Table 7-26 Band Selection Options

Field	Description
2.4 GHz Band	The Find WLANs application list includes all networks found in the 2.4 GHz band (802.11b and 802.11g).
5 GHz Band	The Find WLANs application list includes all networks found in the 5 GHz band (802.11a).

Tap **Save** to save the settings or tap **X** to discard any changes.

System Options

Use **System Options** to set miscellaneous system setting.

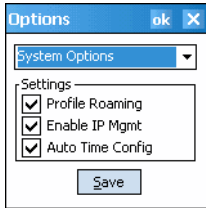

Figure 7-48 System Options Dialog Box

Table 7-27 System Options

Field	Description
Profile Roaming	Configures the EDA to roam to the next available WLAN profile when it moves out of range of the current WLAN profile.
Enable IP Mgmt	Enables the Wireless Companion Services to handle IP address management. The Wireless Companion Service configures the IP based on what is configured in the network profile. Deselect this to manually configure the IP in the standard Windows IP window. Enabled by default.
Auto Time Config	Enables automatic update of the system time. Network association updates the device time based on the time set in the AP. This proprietary feature is only supported with Zebra infrastructure. Enabled by default.

Change Password

Use **Change Password** to require a password before editing a profile. This allows pre-configuring profiles and prevents users from changing the network settings. The user can use this feature to protect settings from a guest user. By default, the password is not set.

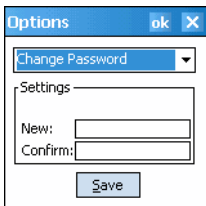

Figure 7-49 Change Password Window

To create a password for the first time, leave the **Current:** text box empty and enter the new password in the **New:** and **Confirm:** text boxes. Tap **Save**.

To change an existing password, enter the current password in the **Current:** text box and enter the new password in the **New:** and **Confirm:** text boxes. Tap **Save**.

To delete the password, enter the current password in the **Current:** text box and leave the **New:** and **Confirm:** text boxes empty. Tap **Save**.



NOTE Passwords are case sensitive and can not exceed 160 characters.

Export

Use **Export** to export all profiles to a registry file, and to export the options to a registry file.

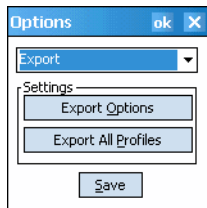

Figure 7-50 Options - Export Dialog Box

To export options:

1. Tap **Export Options**. The **Save As** dialog box displays.

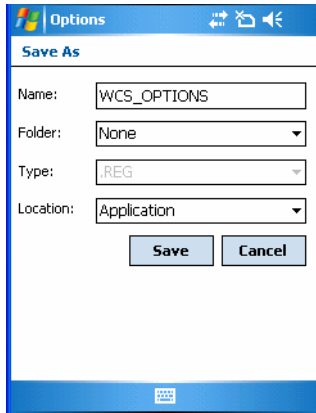

Figure 7-51 Export Options Save As Dialog Box

2. Enter a filename in the **Name:** field. The default filename is WCS_OPTIONS.REG.
3. Tap **Save**.

To export all profiles:

1. Tap **Export All Profiles**. The **Save As** dialog box displays.

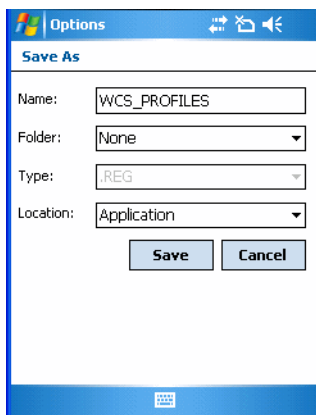

Figure 7-52 Export All Profiles Save As Dialog Box

2. Enter a filename in the **Name:** field. The default filename is WCS_PROFILES.REG.
3. In the **Folder:** drop-down list, select the desired folder.
4. Tap **Save**.

Selecting **Export All Profiles** saves the current profile. This information is used to determine which profile to connect with after a warm boot or cold boot.

Cold Boot Persistence

Export options and profiles to provide cold boot persistence. Save the exported registry files in the *Application* folder to use them on a cold boot and restore previous profile and option settings.

Currently, only server certificates can be saved for cold boot persistence. To save server certificates for cold boot persistence, save the certificate files in the folder *Application* to install the certificates automatically on a cold boot.

✓ **NOTE** User certificates cannot be saved for cold boot persistence at this time.

Registry Settings

Use a registry key to modify some of the parameters. The registry path is:

HKLM\SOFTWARE\Symbol Technologies, Inc.\Configuration Editor

Table 7-28 Registry Parameter Settings

Key	Type	Default	Description												
CertificateDirectory	REG_SZ	\\Application	The default directory to find certificates.												
EncryptionMask	REG_DWORD	0x0000001F	<p>Defines the supported encryption types. This is a bitwise mask with each bit corresponding to an encryption type.</p> <p>1 = Type is supported 0 = Type is not supported</p> <table border="0"> <tr> <td>Bit Number</td> <td>Encryption Type</td> </tr> <tr> <td>0</td> <td>None</td> </tr> <tr> <td>1</td> <td>40-Bit WEP</td> </tr> <tr> <td>2</td> <td>128-Bit WEP</td> </tr> <tr> <td>3</td> <td>TKIP</td> </tr> <tr> <td>4</td> <td>AES (Fusion 2.5 only)</td> </tr> </table>	Bit Number	Encryption Type	0	None	1	40-Bit WEP	2	128-Bit WEP	3	TKIP	4	AES (Fusion 2.5 only)
Bit Number	Encryption Type														
0	None														
1	40-Bit WEP														
2	128-Bit WEP														
3	TKIP														
4	AES (Fusion 2.5 only)														

Log On/Off Application

When the user launches the Log On/Off application, the EDA may be in two states; the user may be logged onto the EDA by already entering credentials through the login box, or there are no user logged on. Each of these states have a separate set of use cases and a different look to the dialog box.

User Already Logged In

If already logged into the EDA, the user can launch the login dialog box for the following reasons:

- Connect to and re-enable a cancelled profile. To do this:

- Launch the Log On/Off dialog.
- Select the cancelled profile from the profile list.
- Login to the profile.

✓ **NOTE** Re-enable cancelled profiles using the Profile Editor Wizard and choosing to connect to the cancelled profile. Cancelled profiles are also re-enabled when a new user logs on.

- Log off the EDA to prevent another user from accessing the current users network privileges.
- Switch EDA users to quickly logoff the EDA and allow another user to log into the EDA.

No User Logged In

If no user is logged into the EDA, launch the login dialog box and log in to access user profiles.

The *Login* dialog box varies if it is:

- Launched by WCS, because the service is connecting to a new profile that needs credentials.
- Launched by WCS, because the service is trying to verify the credentials due to credential caching rules.
- Launched by a user, when a user is logged in.
- Launched by a user, when no user is logged in.

Table 7-29 *Log On/Off Options*

Field	Description
Wireless Profile Field	When launching the login application, the Wireless Profile field has available all the wireless profiles that require credentials. This includes profiles that use EAP-TLS, PEAP, LEAP, and EAP-TTLS.
Profile Status Icon	The profile status icon (next to the profile name) shows one of the following states: The selected profile is cancelled. The selected profile is enabled but is not the current profile. The profile is the current profile (always the case for WCS Launched).
Network Username and Password Fields	The Network Username and Network Password fields are used as credentials for the profile selected in the Wireless Profile field. Currently these fields are limited to 159 characters.
Mask Password Checkbox	The <i>Mask Password</i> checkbox determines whether the password field is masked (i.e., displays only the '*' character) or unmasked (i.e., displays the entered text). Check the box to unmask the password. Uncheck the box to mask the password (the default).
Status Field	The status field displays status that is important to the login dialog. If the user opens the dialog and needs to prompt for credentials for a particular profile at this time, it can use the status field to let the user know that the network is held up by the password dialog being open.

Tapping **OK** sends the credentials though WCS API. If there are no credentials entered, a dialog box displays informing the user which field was not entered.

The **Log Off** button only displays when a user is already logged on. When the **Log Off** button is tapped, the user is prompted with three options: Log Off, Switch Users, and Cancel. Switching users logs off the current user and re-initialize the login dialog box to be displayed for when there is no user logged on. Logging off logs off the current

user and close the login dialog box. Tapping **Cancel** closes the Log Off dialog box and the Login dialog box displays.

When the user is logged off, the EDA only roams to profiles that do not require credentials or to profiles that were created with the credentials entered into the profile

The **Cancel** button closes the dialog without logging into the network. If the login dialog was launched by the WCS and not by the user, tapping **Cancel** first causes a message box to display a warning that the cancel disables the current profile. If the user still chooses to cancel the login at this point, the profile is cancelled.

Once a profile is cancelled, the profile is suppressed until a user actively re-enables it or a new user logs onto the EDA.

Chapter 8 Maintenance and Troubleshooting

Introduction

This chapter includes instructions on cleaning and storing the EDA, and provides troubleshooting solutions for potential problems during EDA operation.

Maintaining the EDA

For trouble-free service, observe the following tips when using the EDA:

- Do not scratch the screen of the EDA. When working with the EDA, use the supplied stylus or plastic-tipped pens intended for use with a touch-sensitive screen. Never use an actual pen or pencil or other sharp object on the surface of the EDA screen.

Zebra recommends using a screen protector, p/n KT-67525-01.

- The touch-sensitive screen of the EDA is glass. Do not drop the EDA or subject it to strong impact.
- Protect the EDA from temperature extremes. Do not leave it on the dashboard of a car on a hot day, and keep it away from heat sources.
- Do not store or use the EDA in any location that is dusty, damp, or wet.
- Use a soft lens cloth to clean the EDA. If the surface of the EDA screen becomes soiled, clean it with a soft cloth moistened with a diluted window-cleaning solution.
- Periodically replace the rechargeable battery to ensure maximum battery life and product performance. Battery life depends on individual usage patterns.

- A screen protector is applied to the EDA. Zebra recommends using this to minimize wear and tear. Screen protectors enhance the usability and durability of touch screen displays. Benefits include:
 - Protection from scratches and gouges
 - Durable writing and touch surface with tactile feel
 - Abrasion and chemical resistance
 - Glare reduction
 - Keeping the device's screen looking new
 - Quick and easy installation.

Troubleshooting

EDA

Table 8-1 *Troubleshooting the EDA*

Problem	Cause	Solution
EDA does not turn on.	Lithium-ion battery not charged.	Charge or replace the lithium-ion battery in the EDA.
	Lithium-ion battery not installed properly.	Ensure battery is installed properly. See Installing and Removing the Main Battery on page 1-3 .
	System crash.	Perform a warm boot. If the EDA still does not turn on, perform a cold boot. See Resetting the EDA on page 1-7 .
Rechargeable lithium-ion battery did not charge.	Battery failed.	Replace battery. If the EDA still does not operate, perform a warm boot, then a cold boot. See Resetting the EDA on page 1-7 .
	EDA removed from cradle while battery was charging.	Insert EDA in cradle. The standard capacity battery (1900 mAh) fully charges in less than four hours. The extended capacity battery (3800 mAh) fully charges in less than eight hours.
Cannot see characters on display.	EDA not powered on.	Press the Power button.
During data communication, no data transmitted, or transmitted data was incomplete.	EDA removed from cradle or disconnected from host computer during communication.	Replace the EDA in the cradle, or reattach the communication cable and re-transmit.
	Incorrect cable configuration.	See the system administrator.
	Communication software was incorrectly installed or configured.	Perform setup as described in Chapter 3, ActiveSync .
EDA does not emit sound.	Volume setting is low or turned off.	Adjust the volume. Refer to the <i>MC70 User Guide</i> .

Table 8-1 Troubleshooting the EDA (Continued)

Problem	Cause	Solution
EDA shuts off.	EDA is inactive.	The EDA turns off after a period of inactivity. If the EDA is running on battery power, set this period from 1 to 5 minutes, in one-minute intervals. If the EDA is running on external power, set this period to 1, 2, 5, 10, 15, or 30 minutes. Check the Power window by selecting Start > Settings > System tab and tapping the Power icon. Select the Advanced tab and change the setting for a longer delay before the automatic shutoff feature activates.
	Battery is not inserted properly.	Insert the battery properly. See Installing and Removing the Main Battery on page 1-3 .
	Battery is depleted.	Replace the battery.
Tapping the window buttons or icons does not activate the corresponding feature.	Screen is not calibrated correctly.	Re-calibrate the screen. See the <i>MC70 User Guide</i> .
	The system is not responding.	Warm boot the system. See Resetting the EDA on page 1-7 .
A message appears stating that the EDA memory is full.	Too many files stored on the EDA.	Delete unused memos and records. If necessary, save these records on the host computer (or use an SD card for additional memory).
	Too many applications installed on the EDA.	Remove unused installed applications from the EDA to recover memory. Select Start > Settings > System tab and tap the Remove Programs icon. Select the unused program and tap Remove .
EDA keeps powering down to protect memory contents.	The EDA's battery is low.	Recharge the battery.
	The radio is powered on for a long time.	Because this mode requires battery power, power it off when not needed. Using the SetDeviceState() API (refer to the <i>SMDK Help File</i>), set the Bluetooth to D4 power state.

Table 8-1 *Troubleshooting the EDA (Continued)*

Problem	Cause	Solution
The EDA does not accept scan input.	Scanning application is not loaded.	Load a scanning application on the EDA. See the system administrator.
	Unreadable bar code.	Ensure the symbol is not defaced.
	Distance between exit window and bar code is incorrect.	Place the EDA within proper scanning range.
	EDA is not programmed for the bar code type.	Program the EDA to accept the type of bar code scanned.
	EDA is not programmed to generate a beep.	If the EDA does not beep on a good decode, set the application to generate a beep on good decode.
	Battery is low.	If the scanner stops emitting a laser beam or aiming pattern upon a trigger press, check the battery level. When the battery is low, the scanner shuts off before the EDA low battery condition notification. Note: If the scanner is still not reading symbols, contact the distributor or Zebra.

Bluetooth Connection

Table 8-2 *Troubleshooting Bluetooth Connection*

Problem	Cause	Solution
EDA cannot find any Bluetooth devices nearby.	Too far from other Bluetooth devices.	Move closer to the other Bluetooth device(s), within a range of 10 meters.
	The Bluetooth device(s) nearby are not turned on.	Turn on the Bluetooth device(s) to find.
	The Bluetooth device(s) are not in discoverable mode.	Set the Bluetooth device(s) to discoverable mode. If needed, refer to the device's user documentation for help.
When trying to connect a Bluetooth phone and EDA, the phone thinks a previously paired EDA is used.	The phone remembers the name and address of the EDA it last paired with via the Bluetooth radio.	Manually delete the pairing device and name from the phone. Refer to the phone's user documentation for instructions.

Table 8-2 Troubleshooting Bluetooth Connection (Continued)

Problem	Cause	Solution
Can't make my Ericsson R520 phone discoverable.	You attempted to bond with the phone, and when the phone presented a "pairing query," you entered No. This prevents the phone from being discoverable until it is reset.	Reset the phone by removing its battery.
There is a delay in the Bluetooth stack re-initializing during a resume from suspend.	This is normal behavior.	No solution required.
Piconet (the connection between a Bluetooth master and one or more Bluetooth slaves) drops.	The EDA suspends and the Bluetooth radio power turns off. One of the devices are out of range.	An application can register for notification of an EDA resume by creating a message queue using the CreateMsgQueue() API and power notifications using the RequestPowerNotifications() API (refer to the <i>SMDK Help File</i>). After an application receives a resume notification it should close open Bluetooth sessions and reopen them. This reestablishes the piconet lost during the suspend.
My application created a successful RFCOMM session with another Bluetooth device but the session was dropped.	Device went out of range or was shut off.	Check the return value of APIs for errors. Look for a DCD state change event in the Microsoft Bluetooth stack DCD window of the Bluetooth connection.
After completing an RFCOMM session with another Bluetooth device, I was unable to create a virtual COM port to connect to another Bluetooth device.	The Microsoft Bluetooth stack holds a baseband connection for ten seconds after an application closes its session and exits. This was designed to allow for speedy connections to the same device if other profiles were to connect.	Either wait 10 seconds, choose a different COM port number for the virtual COM port, or modify HKLM\software\Microsoft\bluetooth\I2cap\IdlePhys (which defines the number of seconds to hold the connection).

Single Slot USB/Serial Cradle

Table 8-3 Troubleshooting the Single Slot USB/Serial Cradle

Symptom	Possible Cause	Action
LEDs do not light when EDA or spare battery is inserted.	Cradle is not receiving power.	Ensure the power cable is connected securely to both the cradle and to AC power.
	EDA is not seated firmly in the cradle.	Remove and re-insert the EDA into the cradle, ensuring it is firmly seated.
	Spare battery is not seated firmly in the cradle.	Remove and re-insert the spare battery into the charging slot, ensuring it is firmly seated.
EDA battery is not charging.	EDA was removed from cradle or cradle was unplugged from AC power too soon.	Ensure cradle is receiving power. Ensure EDA is seated correctly. Confirm main battery is charging under Start > Settings > System > Power . The standard capacity battery (1900 mAh) fully charges in less than four hours. The extended capacity battery (3800 mAh) fully charges in less than eight hours.
	Battery is faulty.	Verify that other batteries charge properly. If so, replace the faulty battery.
	The EDA is not fully seated in the cradle.	Remove and re-insert the EDA into the cradle, ensuring it is firmly seated.
	Ambient temperature of the cradle is too warm.	Move the cradle to an area where the ambient temperature is between 0°C and 35°C.
Spare battery is not charging.	Battery not fully seated in charging slot.	Remove and re-insert the spare battery in the cradle, ensuring it is firmly seated.
	Battery inserted incorrectly.	Re-insert the battery so the charging contacts on the battery align with the contacts on the cradle.
	Battery is faulty.	Verify that other batteries charge properly. If so, replace the faulty battery.
	Ambient temperature of the cradle is too warm.	Move the cradle to an area where the ambient temperature is between 0°C and 35°C.
During data communication, no data transmits, or transmitted data was incomplete.	EDA removed from cradle during communication.	Replace EDA in cradle and retransmit.
	Incorrect cable configuration.	See the system administrator.
	Communication software is not installed or configured properly.	Perform setup as described in Chapter 3, ActiveSync .

Four Slot Ethernet Cradle

Table 8-4 Troubleshooting the Four Slot Ethernet Cradle

Symptom	Cause	Solution
Battery is not charging.	EDA removed from the cradle too soon.	Replace the EDA in the cradle. The standard capacity battery (1900 mAh) fully charges in less than four hours. The extended capacity battery (3800 mAh) fully charges in less than eight hours. Tap Start > Settings > System > Power to view battery status.
	Battery is faulty.	Verify that other batteries charge properly. If so, replace the faulty battery.
	EDA is not inserted correctly in the cradle.	Remove the EDA and reinsert it correctly. Verify charging is active. Tap Start > Settings > System > Power to view battery status.
	Ambient temperature of the cradle is too warm.	Move the cradle to an area where the ambient temperature is between 0°C and 35°C.
During communication, no data was transmitted, or transmitted data was incomplete.	EDA removed from cradle during communication.	Replace EDA in cradle and retransmit.
	EDA has no active connection.	An icon is visible in the status bar if a connection is active.

Vehicle Cradle

Table 8-5 Troubleshooting the Vehicle Cradle

Symptom	Possible Cause	Action
EDA battery charging LED does not light up.	Cradle is not receiving power.	Ensure the power input cable is securely connected to the cradle's power port.
EDA battery is not recharging.	EDA was removed from the cradle too soon.	Replace the EDA in the cradle. The standard capacity battery (1900 mAh) fully charges in less than four hours. The extended capacity battery (3800 mAh) fully charges in less than eight hours.
	Battery is faulty.	Replace the battery.
	EDA is not placed correctly in the cradle.	Remove the EDA from the cradle, and re-insert correctly. If the battery still does not charge, contact customer support. The EDA battery charging LED slowly blinks amber when the EDA is correctly inserted and charging.
	Ambient temperature of the cradle is too warm.	Move to an area where the ambient temperature is between 0°C and 35°C.

Table 8-5 *Troubleshooting the Vehicle Cradle*

Symptom	Possible Cause	Action
No data transmitted, or transmitted data was incomplete.	EDA removed from cradle during communication.	Replace EDA in cradle and retransmit.
	No null modem cable was used.	Some external devices require a null modem cable. Retransmit using a null modem cable.
	Incorrect cable configuration.	See the system administrator.
	Cable missing or disconnected.	Re-connect cable.

Four Slot Spare Battery Charger

Table 8-6 *Troubleshooting the Four Slot Spare Battery Charger*

Symptom	Possible Cause	Action
Battery not charging.	Battery was removed from the charger or charger was unplugged from AC power too soon.	Re-insert the battery in the charger or re-connect the charger's power supply. The standard capacity battery (1900 mAh) fully charges in less than four hours. The extended capacity battery (3800 mAh) fully charges in less than eight hours.
	Battery is faulty.	Verify that other batteries charge properly. If so, replace the faulty battery.
	Battery contacts not connected to charger.	Verify that the battery is seated in the battery well correctly with the contacts facing down.
	Ambient temperature of the cradle is too warm.	Move the cradle to an area where the ambient temperature is between 0°C and 35°C.

Cables

Table 8-7 *Troubleshooting the Cables*

Symptom	Possible Cause	Action
EDA battery is not charging.	EDA was disconnected from AC power too soon.	Connect the power cable correctly. Confirm main battery is charging under Start > Settings > System > Power . The standard capacity battery (1900 mAh) fully charges in less than four hours. The extended capacity battery (3800 mAh) fully charges in less than eight hours.
	Battery is faulty.	Verify that other batteries charge properly. If so, replace the faulty battery.
	The EDA is not fully attached to power.	Detach and re-attach the power cable to the EDA, ensuring it is firmly connected.

Table 8-7 *Troubleshooting the Cables (Continued)*

Symptom	Possible Cause	Action
During data communication, no data transmits, or transmitted data was incomplete.	Cable was disconnected from EDA during communications.	Re-attach the cable and retransmit.
	Incorrect cable configuration.	See the system administrator.
	Communication software is not installed or configured properly.	Perform setup as described in <i>the Chapter 3, ActiveSync</i> .

Magnetic Stripe Reader

Table 8-8 *Troubleshooting the Magnetic Stripe Reader*

Symptom	Possible Cause	Action
MSR does not read card.	MSR removed from EDA during card swipe.	Reattach MSR to EDA and reswipe the card.
	Faulty magnetic stripe on card.	See the system administrator.
	MSR application is not installed or configured properly.	Ensure the MSR application is installed on the EDA. Ensure the MSR application is configured correctly.
EDA battery is not charging.	EDA was removed from MSR or MSR was unplugged from AC power too soon.	Ensure MSR is receiving power. Ensure EDA is attached correctly. Confirm main battery is charging under Start > Settings > System > Power . The standard capacity battery (1900 mAh) fully charges in less than four hours. The extended capacity battery (3800 mAh) fully charges in less than eight hours.
	Battery is faulty.	Verify that other batteries charge properly. If so, replace the faulty battery.
	The EDA is not fully attached to the MSR.	Detach and re-attach the MSR to the EDA, ensuring it is firmly connected.
During data communication, no data transmits, or transmitted data was incomplete.	EDA detached from MSR during communications.	Reattach EDA to MSR and retransmit.
	Incorrect cable configuration.	See the system administrator.
	Communication software is not installed or configured properly.	Perform setup as described in <i>Chapter 3, ActiveSync</i> .

Trigger Handle

Table 8-9 *Troubleshooting the Trigger Handle*

Problem	Cause	Solution
Cannot insert EDA in Trigger Handle.	Cleat is not installed on the EDA.	Install the cleat. Installing the Trigger Handle Cleat on page 2-24.
Scan line does not appear when trigger is pressed.	EDA is not attached properly to the Trigger Handle and is not making contact with the connector.	Remove the EDA from the Trigger Handle and reinsert.
	EDA does not contain a scanning application.	Load a scanning application on the EDA.
	Scanning application is not active.	Start the scanning application.
EDA battery does not charge when Trigger Handle is placed in a cradle.	Trigger Handle is not properly seated in the cradle.	Remove the Trigger Handle from the cradle and reinsert.
	Power is not available to the cradle.	Ensure that power connections to the cradle are connected properly.
Cannot print to printer.	Printer cable not connected properly.	Ensure cable is connected properly to the printer and Trigger Handle.
EDA does not wake from suspend mode when trigger is pressed.	The trigger only wakes the EDA from the suspend mode if a scanning application is active.	Press a key on the EDA to wake from the suspend mode.

Appendix A Technical Specifications

Technical Specifications

The following table summarizes the EDA's intended operating environment and technical hardware specifications.

Table A-1 EDA Technical Specifications

Item	Description
Physical Characteristics	
Dimensions	MC7090: Length:15.3 cm (6 in.) Width: .9 cm (3.1 in.) Depth: 4.4 cm (1.7 in.) MC7004/94: Length: 15.3 cm (6 in.) Width: 7.6 cm (3.0 in.) Depth: 3.7 cm (1.5 in.) MC7095: Length:15.3 cm (6 in.) Width: 7.9 cm (3.1 in.) Depth: 4.4 cm (1.7 in.)
Weight (inc. standard battery)	MC7090: 314 g (11.2 oz.) MC7004/94: 336 g (12 oz.) MC7095: 400 g (14.1oz.)
Display	Transflective color 3.5" QVGA with backlight, TFT-LCD, 65K colors, 240 W x 320 L (QVGA size)
Touch Panel	Glass analog resistive touch
Backlight	LED backlight
Main Battery	Rechargeable Lithium Ion 3.7V, 1900 mAh Smart Battery
Extended Capacity Battery	Optional 3.7V, 3600, 3800and 4800 mAh Smart Batteries

Table A-1 EDA Technical Specifications (Continued)

Item	Description
Backup Battery	NiMH battery (rechargeable) 20mAh 1.2V (not user-accessible)
Expansion Slot	User accessible SDIO slot (with secure cover), accommodates extended cards (with cover removed)
Network Connections	Ethernet (via cradle) High-speed USB, host or client, Bluetooth
Notification	Vibrator and audible alert
Keypad Options	26 Numeric key 44 QWERTY key
Audio	Speaker, receiver, microphone, headset jack, software support for full duplex record and playback (stereo)
Performance Characteristics	
CPU	Intel® XScale™ Bulverde PXA270 processor at 624MHz
Operating System	Microsoft® Windows Mobile® 5.0 or Microsoft Windows Mobile® 6.1
Memory	64MB RAM/128MB ROM
Interface/Communications	RS-232, USB 1.1
User Environment	
Operating Temperature	14°F to 155°F / -10°C to 68°C
Storage Temperature	-40° F to 140° F / -40° C to 60° C
Charging Temperature	32°F to 104°F / 0° C to 40° C
Humidity	95% non-condensing
Drop Specification	4 ft. drop to concrete, 6 drops per 6 sides over operating temperature range; 5 ft. drop to concrete, 2 drops per 6 sides at ambient temperature 73° F/23° C
Electrostatic Discharge (ESD)	+/-15kVdc air discharge, +/-8kVdc direct discharge, +/-8kVdc indirect discharge
Sealing	IP54
Wireless WAN Data and Voice Communications	
Wireless Wide Area (WWAN) radio	MC70004 and MC7094: eGPRS/GSM (850, 900, 1800 and 1900 MHz) MC7095: CDMA2000 1xEV-DO (800 and 1900 MHz)
Wireless LAN Data and Voice Communications	
Wireless Local Area (WLAN) radio	Tri-mode IEEE® 802.11a/b/g
Data Rates Supported	1, 2, 5.5, 6, 9, 11, 12, 18, 24, 36, 48, and 54 Mbps

Table A-1 EDA Technical Specifications (Continued)

Item	Description
Operating Channels	Chan 8-169 (5040 – 5845 MHz) (4920 – 4980 MHz) Japan only Chan 1-13 (2412-2472 MHz) Chan 14 (2484 MHz) Japan only Actual operating frequencies depend on regulatory rules and certification agency
Security	WPA, WEP (40 or 128 bit), TKIP, TLS, TTLS (MS-CHAP), TTLS (MS-CHAP v2), TTLS (CHAP), TTLS-MD5, TTLS-PAP, PEAP-TLS, PEAP (MS-CHAP v2), AES, LEAP
Spreading Technique	Direct Sequence Spread Spectrum (DSSS) and Orthogonal Frequency Division Multiplexing (OFDM)
Antenna	Internal for LAN, External for WAN
Voice Communication	Integrated Voice-over-IP ready (P2P, PBX, PTT), Wi-Fi™-certified, IEEE 802.11a/b/g direct sequence wireless LAN
Wireless PAN Data and Voice Communications	
Bluetooth	Class II, v 1.2
Data Capture Specifications	
Options	2D imager, 1D linear
Linear 1D Scanner (SE800HP) Specifications	
Optical Resolution	0.005 in. minimum element width
Roll	+/- 30° from vertical
Pitch Angle	+/- 65° from normal
Skew Tolerance	+/- 60° from normal
Ambient Light	Sunlight: 8,000 ft. candles (86,112 Lux) Artificial Light: 450 ft. candles (4,844 Lux)
Shock	2,000 +/- 5% G
Scan Rate	50 (+/- 6) scans/sec (bidirectional)
Scan Angle	46.5° (typical)
Laser Power	1.0 mW nominal
2D Imager Engine (SE 4400) Specifications	
Field of View	Horizontal - 32.2° Vertical - 24.5°
Optical Resolution	640 H x 480 V pixels (gray scale)
Roll	360°
Pitch Angle	+/- 60° from normal

Table A-1 EDA Technical Specifications (Continued)

Item	Description
Skew Tolerance	+/- 50° from normal
Ambient Light	Total darkness to 9,000 ft. candles (96,900 Lux)
Shock	2,000 +/- 5% G
Focal Distance from Front of Engine	Near: 5 inches Far: 9 inches
Aiming Element (VLD)	650 nm +/- 5 nm
Illumination Element (LED)	635 nm +/- 20 nm

MC70 Accessory Specifications

Table A-2 Single Slot USB/Serial Cradle Technical Specifications

Feature	Description
Dimensions	4.3 in. L x 2.3 in. W x 3.2 in. H (10.92 cm L x 5.84 cm W x 8.13 cm H)
Weight	6.9 oz (196 g)
Power	12 V
Interface	USB, Serial
Operating Temperature	32° to 122° F (0° to 50° C)
Storage Temperature	-40° to 158° F (-40° to 70° C)
Charging Temperature	32° to 104° F (0° to 40° C)
Humidity	5% to 95% non-condensing
Drop	30.0 in. (76.2 cm) drops to vinyl tiled concrete at room temperature
Electrostatic Discharge (ESD)	+/- 15 kV air +/- 8 kV contact

Table A-3 Four Slot Ethernet Cradle Technical Specifications

Feature	Description
Dimensions	5.40 in. H x 18.25 in. W x 4.38 in. D (13.72 cm H x 46.36 cm W x 11.13 cm D)
Weight	2.38 lb (1079 g)
Power	12 V

Table A-3 *Four Slot Ethernet Cradle Technical Specifications (Continued)*

Feature	Description
Interface	Ethernet
Operating Temperature	32° to 122° F (0° to 50° C)
Storage Temperature	-40° to 158° F (-40° to 70° C)
Charging Temperature	32° to 104° F (0° to 40° C)
Humidity	5% to 95% non-condensing
Drop	30.0 in. (76.2 cm) drops to vinyl tiled concrete at room temperature
Electrostatic Discharge (ESD)	+/- 15 kV air +/- 8 kV contact

Table A-4 *Four Slot Spare Battery Charger Technical Specifications*

Feature	Description
Dimensions	8.25 in. L x 6.0 in. W x 1.7 in. H (20.96 cm L x 15.24 cm W x 4.32 cm H)
Weight	13.6 oz (386 g)
Power	12 V
Operating Temperature	32° to 104° F (0° to 40° C)
Storage Temperature	-40° to 158° F (-40° to 70° C)
Charging Temperature	32° to 104° F (0° to 40° C)
Humidity	5% to 95% non-condensing
Drop	30.0 in. (76.2 cm) drops to vinyl tiled concrete at room temperature
Electrostatic Discharge (ESD)	+/- 15 kV air +/- 8 kV contact

Table A-5 *Magstripe Reader (MSR) Technical Specifications*

Feature	Description
Dimensions	3.1 in. L x 3.3 in. W x 1.4 in. H (7.87 cm L x 8.38 cm W x 3.56 cm H)
Weight	1.7 oz (48 g)
Interface	Serial with baud rate up to 19,200
Format	ANSI, ISO, AAMVA, CA DMV, user-configurable generic format
Swipe Speed	5 to 50 in. (127 to 1270 mm) /sec, bi-directional
Decoders	Generic, Raw Data
Mode	Buffered, unbuffered

Table A-5 *Magstripe Reader (MSR) Technical Specifications (Continued)*

Feature	Description
Track Reading Capabilities	Tracks 1 and 3: 210 bpi Track 2: 75 and 210 bpi, autodetect
Operating Temperature	32° to 122° F (0° to 50° C)
Storage Temperature	-40° to 158° F (-40° to 70° C)
Humidity	5% to 95% non-condensing
Drop	4 ft. (1.22 m) drops to concrete
Electrostatic Discharge (ESD)	+/- 15 kV air +/- 8 kV contact

COM Port Definitions

Table A-6 *MC70 External COM Connector Definitions*

COM Port	Definition
COM1	Scanner
COM2	Available
COM3	IRComm
COM4	Raw IrDA
COM5	External Connector
COM6	Available
COM7	Available
COM8	Available
COM9	Available

Pin-Outs

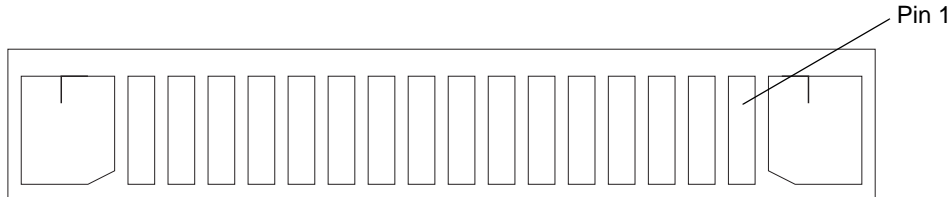

Figure A-1 External Connector

Table A-7 External Connector Pin-Outs

Pin	Description
1	Power Gnd
2	CRADLE_DETECT
3	RS232_DCD/TRIGGER
4	USB_D-
5	USB_D+
6	USB_Gnd
7	USB_Vbus
8	USB_ID
9	RS232_TXD
10	RS232_RXD
11	RS232_RTS
12	RS232_CTS
13	RS232_DTR
14	RS232_DSR
15	External_5.0V_Out
16	External DC In_5.4V

Appendix B Software Configuration

Radio Power Status LED

The MC70 has three LED indicators. The Scan/Decode LED indicates status for scanning. The Charge Status LED indicates status for main battery charging. The Radio Power Status LED indicates radio status. The Radio Power Status LED is disabled by default. To enable the LED a registry key must be changed.

To enable the LED change the following registry key setting:

```
[HKEY_LOCAL_MACHINE\SOFTWARE\Symbol\RFLEDKey]
"NoBlink"=dword:00000001
```

where:

dword:0 = enabled

dword:1 = disabled

After setting the registry key, warm boot the MC70.

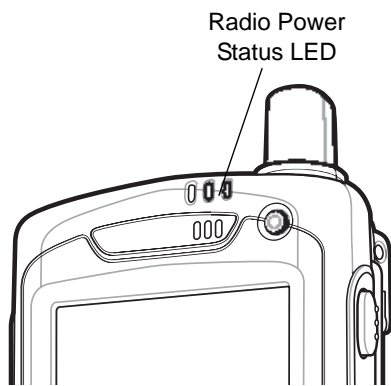

Figure B-1 *Radio Power Status LED Indicator*

Table B-1 *Radio Power Status LED Indications*

LED State	Indication
Slow Blinking Green	Any one of the radios is on.
Off	No radio is on.

Appendix C Windows Mobile 6.1 Upgrade Procedures

Introduction

This chapter provides installation instructions for updating the MC70 with Windows Mobile 5.0 to Windows Mobile 6.1.

To upgrade a Windows Mobile 5.0 device to Windows Mobile 6.1, it is required to download a Windows Mobile 6.1 license key from the Zebra Software Technology Center web site and the upgrade software from the Zebra Support Central web site.

The upgrade methods discussed in this appendix are:

- **Secure Boot Loader Method** - Use this method to upgrade an MC70 with Windows Mobile 5.0.
- **AirBEAM Method** - Use this method to upgrade an MC70 with Windows Mobile 5.0 using AirBEAM.
- **Update Loader Method** - Use this method to upgrade an MC70 with Windows 6.1 with a newer operating system version.

Download License Package



NOTE You must purchase an upgrade license for each device that you plan on upgrading. Record the serial numbers for all devices that you plan to upgrade. Details can be found at the Software Technology Center, <http://www.zebra.com/support>.

To download the license package:

1. Go to <http://www.zebra.com/support>.
2. Select the appropriate license package file.
3. Save the package to a directory on a host computer (for example: c:\MC70LicensePackage).
4. Un-compress the license package file. An *MC70* sub-directory, with a file, *70XXw61LxxLPxxxxxx.sig*, is created.

Download Upgrade Package

Download the Upgrade Package from the Zebra Support Central web site.

1. Go to <http://www.zebra.com/support>.
2. Select **Mobile Computers** and then select **MC70**.
3. In the **Software Download** section, select the MC70 Windows Mobile 6.1 Upgrade Image link.
4. Click on the link and follow the instructions for downloading the upgrade files.
5. Save the files to a directory on a host computer (for example: c:\MC70UpgradePackage).
 - 70XXw61LxxMPxxxxxx.zip - Contains files required to upgrade using AirBEAM method.
 - 70XXw61LxxSPxxxxxx.zip - Contains files required to upgrade using SBL method.
 - 70XXw61LxxUPxxxxxx.zip - Contains files required to upgrade using UpdateLoader method.
 - SSTFWUpdatexxxxxxVx.x.cab - NAND Flash Firmware update utility.
6. Un-compress the upgrade zip files.

Secure Boot Loader Upgrade Method

The following steps must be performed to upgrade an MC70 from Windows Mobile 5.0 to Windows Mobile 6.1. The NAND Flash update must be performed prior to the upgrade package installation.

1. NAND Flash Firmware Update.
2. Windows Mobile 6.1 Upgrade Package.

Requirements

To following are required:

- MC70 device with Windows Mobile 5.0
- Cradle and power source.
- Zebra approved SD card with at least 80 MB free space or
- USB cable.

NAND Flash Firmware Update

The NAND Flash firmware can be updated using an SD card or the MC70 internal memory.

Using an SD Card

To update the NAND Flash Firmware using an SD card:

1. Connect an SD card to the host computer using an SD card reader.
2. On the host computer, locate the *c:\MC70UpgradePackage* directory. See [Download Upgrade Package on page C-2](#).

3. Copy the CAB file (SSTFWUpdatexxxxxvX.X.cab) to the root directory of an SD card. The SD card must be un-locked and have at least 80 MB of free space.
4. Remove the SD card from the host computer.
5. Remove the MC70 SD Card cover.
6. Insert the SD Card into the MC70 SD card slot.
7. Replace the SD Card cover.
8. Connect the MC70 to AC power with a cradle or charging cable.
9. On the MC70, select **Start > Programs > File Explorer**.
10. Navigate to the *Storage Card* folder.
11. Tap the SSTFWUpdatexxxxxvX.X.cab file.
The update begins and when completed performs a clean boot.

Using MC70 Internal Memory

To update the NAND Flash Firmware using the MC70 internal memory:

1. Connect the MC70 to the host computer using ActiveSync.
2. On the host computer, open **Microsoft ActiveSync**.
3. Click on **Explore**.
4. Navigate to the *Application* folder.
5. On the host computer, locate the *c:/MC70UpgradePackage* directory. See [Download Upgrade Package on page C-2](#).
6. Copy the CAB (SSTFWUpdatexxxxxvX.X.cab) file to the *Application* folder.
7. On the MC70, select **Start > Programs > File Explorer**.
8. Navigate to the *Application* folder.
9. Tap the SSTFWUpdatexxxxxvX.X.cab file.
The update begins and when completed performs a clean boot.

Upgrade Package Installation

To install the update package:

1. Connect an SD Card to the host computer using a SD card reader.
2. On the host computer, locate the *c:/MC70UpgradePackage* directory. See [Download Upgrade Package on page C-2](#).
3. Un-compress the zip file, 70XXw61LxxSPxxxxx.zip. A sub-directory, *WM6.1_SBLUpdate*, is created.
4. Copy all the files from the *WM6.1_SBLUpdate* directory to the root directory of an SD card. The SD Card must be un-locked and have at least 80 MB of free space.

5. On the host computer, locate the `c:\MC70LicensePackage` directory. See [Download License Package on page C-1](#).
6. Copy the license key file, `70XXw61LxxLPxxxxxx.sig`, to the `MC70` folder on the SD card.
7. Remove the SD card from the host computer.
8. Remove the MC70 SD Card cover.
9. Insert the SD card into the MC70 SD card slot.
10. Replace the SD Card cover.
11. Connect the MC70 to AC power with a cradle or charging cable.
12. On the MC70, select **Start > Programs > File Explorer**.
13. Navigate to the *Storage Card* folder.

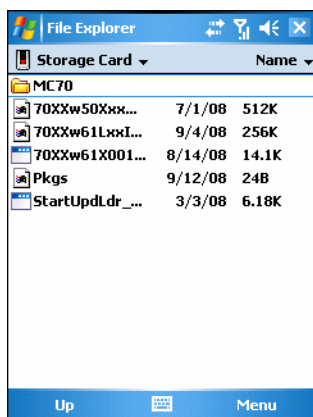

Figure C-1 MC70 Storage Card Folder

14. Tap on the file: `70XXw61X001Upgrade.exe`.
15. The Secure Boot Loader (SBL) is flashed onto the device and then it automatically flashes the rest of the images in SBL mode.
16. After the last download, the MC70 reboots automatically and the Windows Mobile 6.1 calibration screen appears. The MC70 is now fully upgraded and ready to use.

Troubleshooting Upgrade Procedures

- When I launch the **70XXw61X001Upgrade.exe**, I get a message box saying “Device NOT licensed!! Public upgrade can happen only on licensed device”.
 - For the first time upgrade from Windows Mobile 5.0 to Windows Mobile 6.1, a Windows Mobile 6.1 license file (`70XXw61LxxLP020101.zip`) from the Zebra Software Technology Central web site is required. Once this file is obtained, re-perform the procedure.
- When I launch the `70XXw61X001Upgrade.exe`, I get a message box saying “XXXXXXXXXXXXXXXX!! Make sure the upgrade package is not tampered”.
 - This error occurs when either the upgrade package was copied partially to the SD card or some of the files were corrupted during the copy process. Try deleting the SD card contents and copying again. In case the problem persists, try another SD card.

- When I launch the 70XXw61X001Upgrade.exe, I get a message box saying “Error during upgrade!!”
 - Ensure that the SD card is not write protected (locked). If so, unlock the SD card and retry.
- When I launch the 70XXw61X001Upgrade.exe, upgrade starts, SBL gets flashed, but while trying to flash XXX partition SBL displays message “Cannot find XXX. Cannot download files.”
 - Make sure the SD card used is amongst the list of supported SD cards for the device. Exit from the SBL menu. (You can navigate using UP and DOWN arrow keys and select using Enter key). Once the device boots up repeat the steps above with a supported SD card.

AirBEAM Upgrade Method

Requirements

To following are required:

- MC70 device with Windows Mobile 5.0
- AirBEAM Package Builder installed on host computer.

Update Procedure

For upgrading large number of devices wirelessly, an AirBEAM Package File (*.apf) needs to be generated using the 70XXw61LxxMPxxxxxx.zip file.

AirBEAM Upgrade from Windows Mobile 5.0 to Windows Mobile 6.1 can be performed with or without SD card support. In case an upgrade requiring no SD card is desired, ensure that the device has at least 52MB of free storage memory.

To upgrade using AirBEAM:

1. On the host computer, locate the *c:/MC70UpgradePackage* directory. See [Download Upgrade Package on page C-2](#).
2. Un-compress the zip file, 70XXw61LxxMPxxxxxx.zip. A sub-directory, *AirBeamUpgrade*, is created.



NOTE *In case the devices are being upgraded to Windows Mobile 6.1 released images (non Beta) for the first time, Windows Mobile 6.1 License file (IP) is required. If the device has been upgraded in the past, no license file is required.*

3. Locate the Upgrade License Package files at *c:/MC70LicensePackage* directory. See [Download License Package on page C-1](#).
4. Copy the resulting *MC70* sub-directory and contents to the AirBEAM Upgrade directory, *c:/MC70UpgradePackage/AirBeamUpgrade*.
5. Launch *AirBEAM Package Builder*. Select **File > New Project**. Enter a name for the package e.g. *MC7094W61Upgrade* and click **OK**.
6. Select a location to save the AirBEAM Package Project file.
7. The main project window appears.

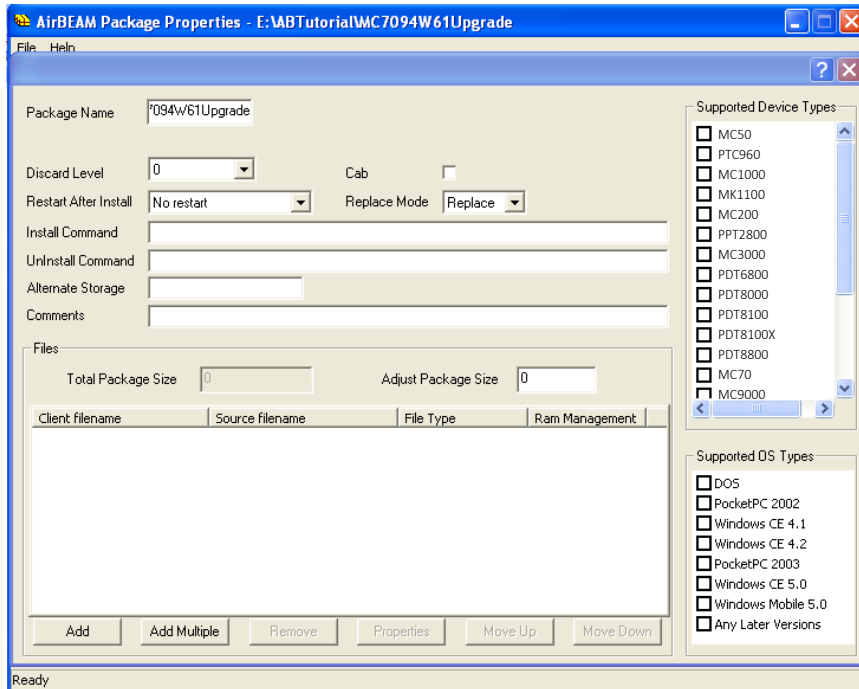

Figure C-2 AirBEAM Package Builder Window

8. Click the **Add Multiple** button. The **ADD multiple component files** dialog box appears.

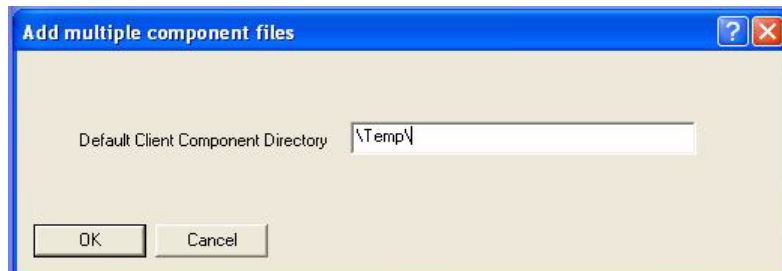

Figure C-3 Add Multiple Component Files Dialog Box

9. In the **Default Client Component Directory** text box, enter \\Temp\.
10. Click **OK**. The **Select File** dialog box appears.

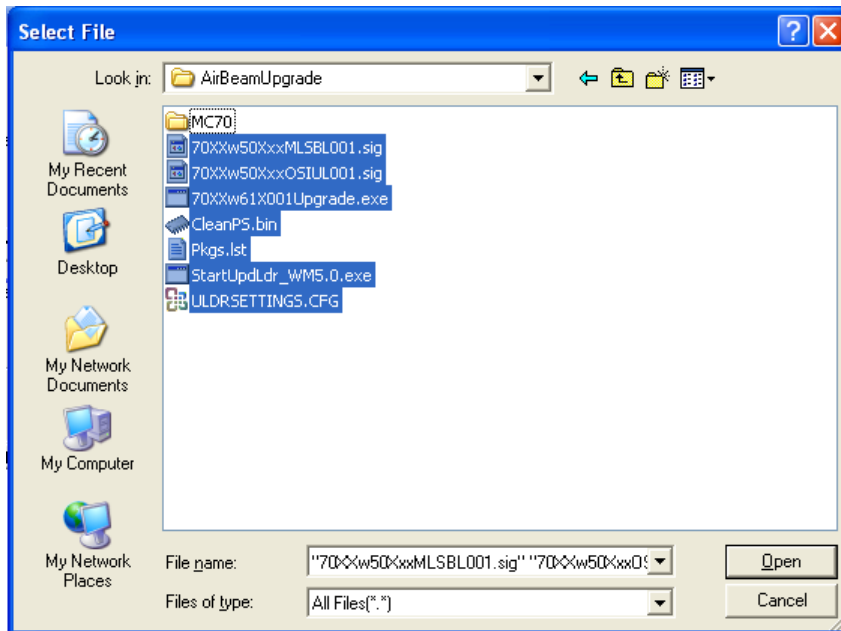

Figure C-4 Select File Dialog Box

11. Navigate to the directory where the AirBEAMUpgrade folder was extracted in step 2.
12. Select all the files inside the AirBeamUpgrade folder except for the MC70 folder and then click **Open**.
This adds all these files into the package as shown below.

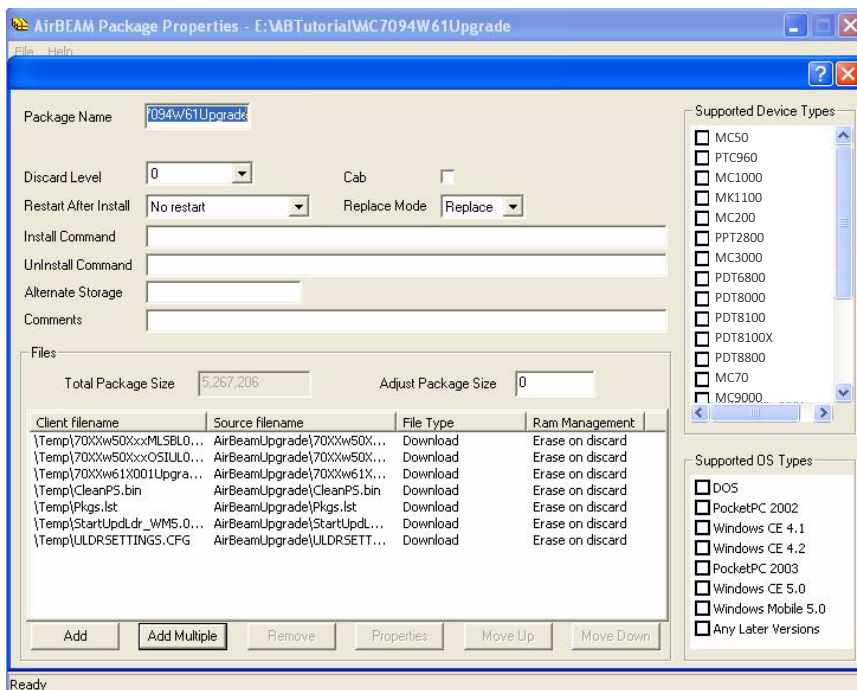

Figure C-5 AirBEAM Package Builder Window

13. Click **Add Multiple**. The **Add multiple component files** dialog box appears.

14. If using a storage card, in the **Default Client Component Directory** text box, enter `\Storage Card\MC70\` and click **OK**.

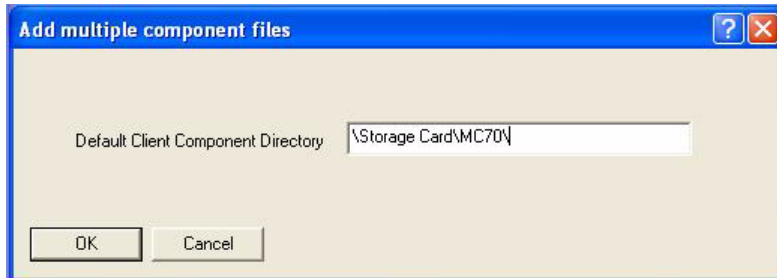

Figure C-6 Add Multiple Component Files Dialog Box - Using SD Card

- If not using a storage card, in the **Default Client Component Directory** text box, enter `\Temp\MC70\` and click **OK**.

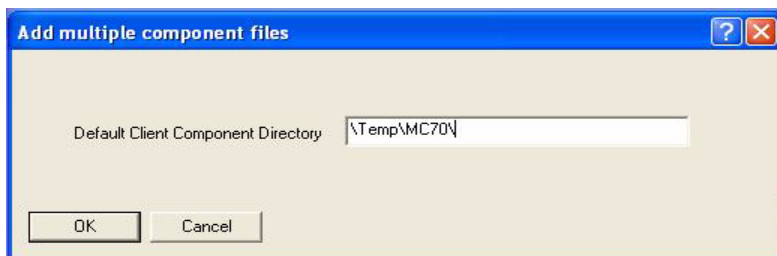

Figure C-7 Add Multiple Component Files Dialog Box - Using Temp Directory

15. The **Select File** dialog box appears. Browse to the location where AirbeamUpgrade folder was extracted in step 2. Browse inside the **MC70** folder within AirbeamUpgrade folder. Select all files inside the MC70 folder and click **Open**.

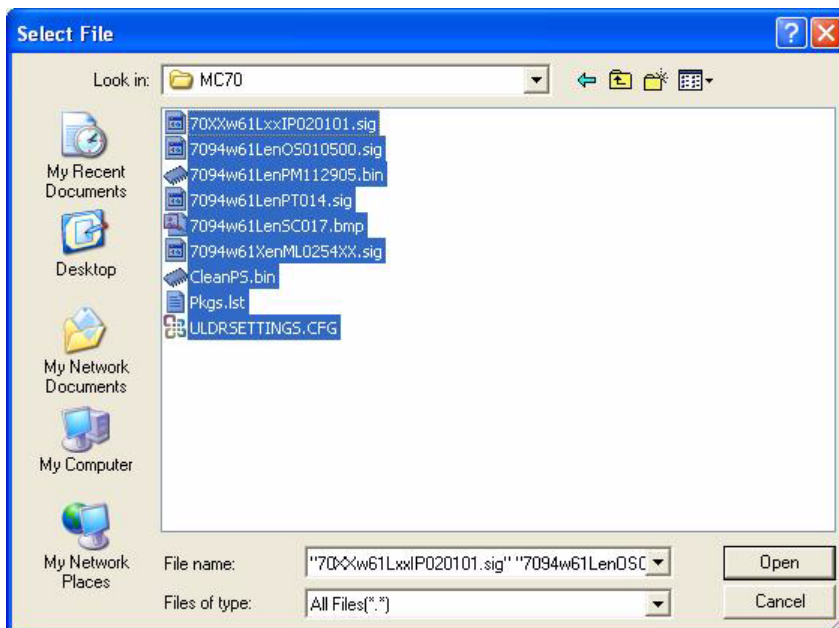

Figure C-8 Select File Dialog Box

16. This adds all these files into the package.

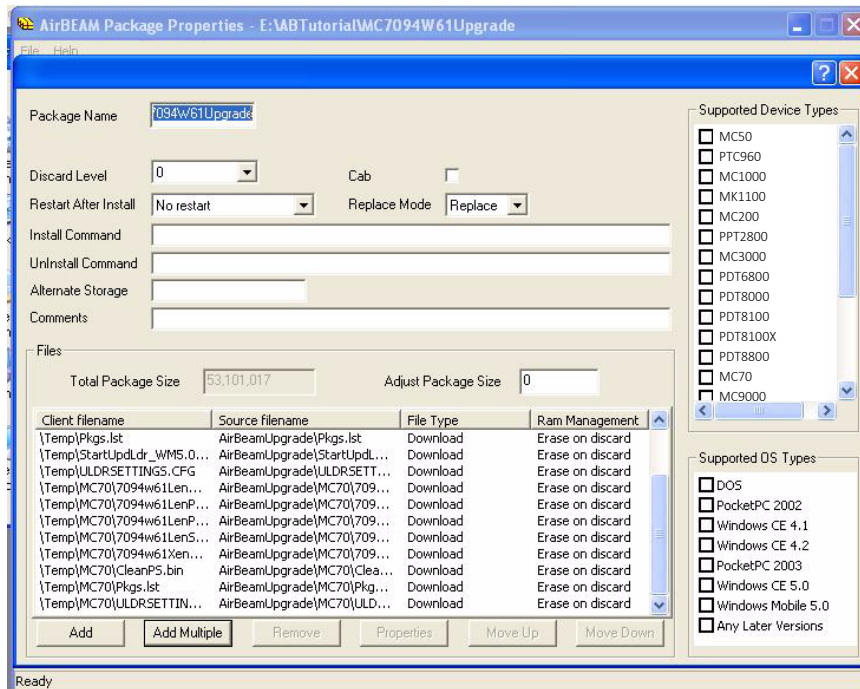

Figure C-9 AirBEAM Package Builder Window

17. In the **Install Command** text box, enter \Temp\70XXw61X001Upgrade.exe.

18. In the **Alternate Storage** text box, enter \Temp.

19. In the **Supported Device Types** list, select **MC70**.

20. In the **Supported OS Types** list, select **Windows Mobile 5.0** and **Any Later Versions**.

After these steps, package properties page should look like this.

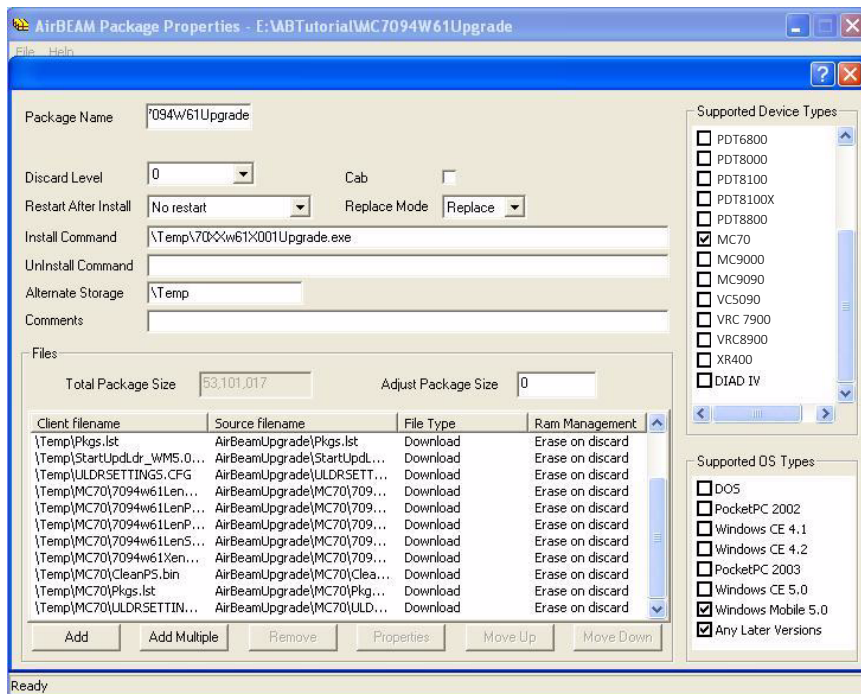

Figure C-10 Select Supported OS Types

21. Select **File > Generate APF File**. The **Generate APF:Version number** dialog box appears.

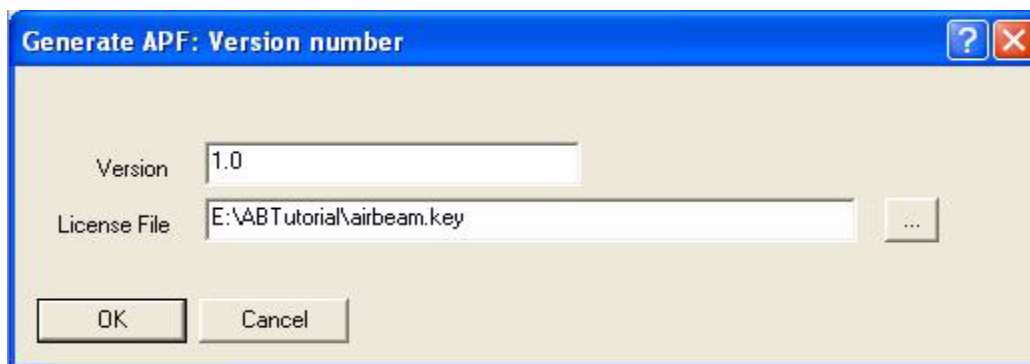

Figure C-11 Generate APF: Version Number Dialog Box

22. In the **Version** text box, enter the version number of the package desired.

23. In the **License File** text box, enter the full path of the license file.

24. Click **OK**.

NOTE AirBEAM license file is required for building any type of AirBEAM packages that are to be used with licensed clients. These files are specific to different customers and can be procured from Zebra EMB Marketing group.

25. Enter the desired name of the apf file, e.g. MC7094W61Upgrade.apf and click **Save**. This generates the APF file.

26. Deploy the AirBEAM Package. Refer to the MSP 3.1 User Guide for more information.

Troubleshooting AirBEAM Upgrade Procedures

- Once the upgrade starts, a message box with “Device NOT licensed!! Public upgrade can happen only on licensed device” appears.
 - For the first time upgrade from Windows Mobile 5.0 to Windows Mobile 6.1, you need to purchase the Windows Mobile 6.1 license and retrieve the Windows Mobile 6.1 license file (70XXw61LxxLPxxxxxx.zip) from Zebra Software Technology Center web site at <http://www.zebra.com/support>. Once this file is obtained, follow the above instructions.
- I am currently running Windows Mobile 6.1 Beta images. Can I use the above mentioned method to upgrade to the released images?
 - Yes, you can use the above mentioned method (SBL Upgrade and AirBEAM upgrade) to upgrade to this released image. You need to purchase the Windows Mobile 6.1 license file (70XXw61LxxLPxxxxxx.zip) from Software Technology Center at <http://www.zebra.com/support> before the upgrade.
- I started the AirBEAM upgrade, but after upgrade my device fails to boot up and is stuck on Zebra Splash screen.
 - This scenario might occur when you try installing an AirBEAM package built for a storage card (see step 9 above) onto a device having no storage card. In order to recover such device do the following:
 1. Take the storage card from a device where this package was successfully installed.
 2. Insert this storage card into the device.
 3. Cold boot the device (by pressing Pwr+1+9).
 4. Immediately after that hold the scan keys (yellow buttons at the side of the device).
 5. The Secure Boot Loader screen comes up. “UpdateLoader” is selected by default. Release the trigger keys.
 6. The device reboots to UpdateLoader and flash the images from the SD card.

UpdateLoader Update Method

This method is used to update an MC70 with Windows Mobile 6.1 with a newer version of Windows Mobile 6.1.

Requirements

The following are required:

- MC70 device with Windows Mobile 6.1
- Zebra approved SD card with at least 80 MB free space.
- Cradle and power source.
- USB cable.

Update Loader Procedure

To update the MC70 with Windows Mobile 6.1 with a newer operating system version:

1. Connect an SD Card to the host computer using a SD card reader.

2. On the host computer, locate the MC70 Windows Mobile 6.1 Upgrade Package file, 70XXw61LxxUPxxxxxx.zip, downloaded from the Zebra Support Center web site. See [Download Upgrade Package on page C-2](#).
3. Un-compress the zip file. A sub-directory, *UpdateLoader*, is created.
4. Connect an SD card to the host computer using a SD card reader.
5. On the host computer, locate the MC70 Windows Mobile 6.1 Upgrade Package downloaded from the Zebra Support Center web site. See [Download Upgrade Package on page C-2](#).
6. Copy all the files from the *UpdateLoader* directory to the root directory of an SD card. The SD card must be un-locked and have at least 80 MB of free space.
7. Remove the SD card from the host computer.
8. Remove the MC70 SD Card cover.
9. Insert the SD card into the MC70 SD card slot.
10. Replace the SD Card cover.
11. Connect the MC70 to AC power with a cradle or charging cable.
12. On the MC70, select **Start > Programs > File Explorer**.
13. Navigate to the *Storage Card* folder.
14. Tap on the file: StartUpdLdr.exe.
15. After the last download, the MC70 reboots automatically and the Windows Mobile 6.1 calibration screen appears. The MC70 is now fully upgraded and ready to use.

✓ **NOTE** UpdateLoader package (7094w61LenUPxxxxxx.zip) cannot be used to upgrade devices running Windows Mobile 5.0 or Windows Mobile 6.1 Beta. For such devices use the SBL Update Method or the AirBEAM Update Method.

Glossary

A

API. An interface by means of which one software component communicates with or controls another. Usually used to refer to services provided by one software component to another, usually via software interrupts or function calls

Aperture. The opening in an optical system defined by a lens or baffle that establishes the field of view.

Application Programming Interface. See **API**.

ANSI Terminal. A display terminal that follows commands in the ANSI standard terminal language. For example, it uses escape sequences to control the cursor, clear the screen and set colors. Communications programs support the ANSI terminal mode and often default to this terminal emulation for dial-up connections to online services.

ASCII. American Standard Code for Information Interchange. A 7 bit-plus-parity code representing 128 letters, numerals, punctuation marks and control characters. It is a standard data transmission code in the U.S.

Autodiscrimination. The ability of an interface controller to determine the code type of a scanned bar code. After this determination is made, the information content is decoded.

B

Bar. The dark element in a printed bar code symbol.

Bar Code. A pattern of variable-width bars and spaces which represents numeric or alphanumeric data in machine-readable form. The general format of a bar code symbol consists of a leading margin, start character, data or message character, check character (if any), stop character, and trailing margin. Within this framework, each recognizable symbology uses its own unique format. See **Symbology**.

Bar Code Density. The number of characters represented per unit of measurement (e.g., characters per inch).

Bar Height. The dimension of a bar measured perpendicular to the bar width.

Bar Width. Thickness of a bar measured from the edge closest to the symbol start character to the trailing edge of the same bar.

BIOS. Basic Input Output System. A collection of ROM-based code with a standard API used to interface with standard PC hardware.

Bit. Binary digit. One bit is the basic unit of binary information. Generally, eight consecutive bits compose one byte of data. The pattern of 0 and 1 values within the byte determines its meaning.

Bits per Second (bps). Bits transmitted or received.

BOOTP. A protocol for remote booting of diskless devices. Assigns an IP address to a machine and may specify a boot file. The client sends a bootp request as a broadcast to the bootp server port (67) and the bootp server responds using the bootp client port (68). The bootp server must have a table of all devices, associated MAC addresses and IP addresses.

boot or boot-up. The process a computer goes through when it starts. During boot-up, the computer can run self-diagnostic tests and configure hardware and software.

bps. See **Bits Per Second**.

Byte. On an addressable boundary, eight adjacent binary digits (0 and 1) combined in a pattern to represent a specific character or numeric value. Bits are numbered from the right, 0 through 7, with bit 0 the low-order bit. One byte in memory is used to store one ASCII character.

C

CDRH. Center for Devices and Radiological Health. A federal agency responsible for regulating laser product safety. This agency specifies various laser operation classes based on power output during operation.

CDRH Class 1. This is the lowest power CDRH laser classification. This class is considered intrinsically safe, even if all laser output were directed into the eye's pupil. There are no special operating procedures for this class.

CDRH Class 2. No additional software mechanisms are needed to conform to this limit. Laser operation in this class poses no danger for unintentional direct human exposure.

Character. A pattern of bars and spaces which either directly represents data or indicates a control function, such as a number, letter, punctuation mark, or communications control contained in a message.

Character Set. Those characters available for encoding in a particular bar code symbology.

Check Digit. A digit used to verify a correct symbol decode. The scanner inserts the decoded data into an arithmetic formula and checks that the resulting number matches the encoded check digit. Check digits are required for UPC but are optional for other symbologies. Using check digits decreases the chance of substitution errors when a symbol is decoded.

Codabar. A discrete self-checking code with a character set consisting of digits 0 to 9 and six additional characters: (- \$: / , +).

Code 128. A high density symbology which allows the controller to encode all 128 ASCII characters without adding extra symbol elements.

Code 3 of 9 (Code 39). A versatile and widely used alphanumeric bar code symbology with a set of 43 character types, including all uppercase letters, numerals from 0 to 9 and 7 special characters (- . / + % \$ and space). The code name is derived from the fact that 3 of 9 elements representing a character are wide, while the remaining 6 are narrow.

Code 93. An industrial symbology compatible with Code 39 but offering a full character ASCII set and a higher coding density than Code 39.

Code Length. Number of data characters in a bar code between the start and stop characters, not including those characters.

Cold Boot. A cold boot restarts the mobile computer and erases all user stored records and entries.

COM port. Communication port; ports are identified by number, e.g., COM1, COM2.

Continuous Code. A bar code or symbol in which all spaces within the symbol are parts of characters. There are no intercharacter gaps in a continuous code. The absence of gaps allows for greater information density.

Cradle. A cradle is used for charging the terminal battery and for communicating with a host computer, and provides a storage place for the terminal when not in use.

D

Data Communications Equipment (DCE). A device (such as a modem) which is designed to attach directly to a DTE (Data Terminal Equipment) device.

DCE. See **Data Communications Equipment**.

DCP. See **Device Configuration Package**.

Dead Zone. An area within a scanner's field of view, in which specular reflection may prevent a successful decode.

Decode. To recognize a bar code symbology (e.g., UPC/EAN) and then analyze the content of the specific bar code scanned.

Decode Algorithm. A decoding scheme that converts pulse widths into data representation of the letters or numbers encoded within a bar code symbol.

Decryption. Decryption is the decoding and unscrambling of received encrypted data. Also see, **Encryption** and **Key**.

Depth of Field. The range between minimum and maximum distances at which a scanner can read a symbol with a certain minimum element width.

Device Configuration Package. The Device Configuration Package provides the Product Reference Guide (PRG), flash partitions, Terminal Configuration Manager (TCM) and the associated TCM scripts. With this package hex images that represent flash partitions can be created and downloaded to the mobile computer.

Discrete Code. A bar code or symbol in which the spaces between characters (intercharacter gaps) are not part of the code.

Discrete 2 of 5. A binary bar code symbology representing each character by a group of five bars, two of which are wide. The location of wide bars in the group determines which character is encoded; spaces are insignificant. Only numeric characters (0 to 9) and START/STOP characters may be encoded.

DRAM. Dynamic random access memory.

DTE. See **Data Terminal Equipment**.

E

EAN. European Article Number. This European/International version of the UPC provides its own coding format and symbology standards. Element dimensions are specified metrically. EAN is used primarily in retail.

Element. Generic term for a bar or space.

EMDK. EnterpriseMobility Developer's Kit.

Encoded Area. Total linear dimension occupied by all characters of a code pattern, including start/stop characters and data.

ENQ (RS-232). ENQ software handshaking is also supported for the data sent to the host.

ESD. Electro-Static Discharge

F

File Transfer Protocol (FTP). A TCP/IP application protocol governing file transfer via network or telephone lines. See **TCP/IP**.

Flash Disk. An additional megabyte of non-volatile memory for storing application and configuration files.

Flash Memory. Flash memory is nonvolatile, semi-permanent storage that can be electronically erased in the circuit and reprogrammed. Series 9000 mobile computers use Flash memory to store the operating system (ROM-DOS), the terminal emulators, and the Citrix ICA Client for DOS.

FTP. See **File Transfer Protocol**.

H

Hard Reset. See **Cold Boot**.

Hz. Hertz; A unit of frequency equal to one cycle per second.

Host Computer. A computer that serves other terminals in a network, providing such services as computation, database access, supervisory programs and network control.

I

IDE. Intelligent drive electronics. Refers to the solid-state hard drive type.

IEC. International Electrotechnical Commission. This international agency regulates laser safety by specifying various laser operation classes based on power output during operation.

IEC (825) Class 1. This is the lowest power IEC laser classification. Conformity is ensured through a software restriction of 120 seconds of laser operation within any 1000 second window and an automatic laser shutdown if the scanner's oscillating mirror fails.

IEEE Address. See **MAC Address**.

Input/Output Ports. I/O ports are primarily dedicated to passing information into or out of the terminal's memory. Series 9000 mobile computers include Serial and USB ports.

Interleaved 2 of 5. A binary bar code symbology representing character pairs in groups of five bars and five interleaved spaces. Interleaving provides for greater information density. The location of wide elements (bar/spaces) within each group determines which characters are encoded. This continuous code type uses no intercharacter spaces. Only numeric (0 to 9) and START/STOP characters may be encoded.

Intercharacter Gap. The space between two adjacent bar code characters in a discrete code.

Interleaved Bar Code. A bar code in which characters are paired together, using bars to represent the first character and the intervening spaces to represent the second.

Internet Protocol Address. See **IP**.

IOCTL. Input/Output Control.

I/O Ports. interface The connection between two devices, defined by common physical characteristics, signal characteristics, and signal meanings. Types of interfaces include RS-232 and PCMCIA.

IP. Internet Protocol. The IP part of the TCP/IP communications protocol. IP implements the network layer (layer 3) of the protocol, which contains a network address and is used to route a message to a different network or subnetwork. IP accepts "packets" from the layer 4 transport protocol (TCP or UDP), adds its own header to it and delivers a "datagram" to the layer 2 data link protocol. It may also break the packet into fragments to support the maximum transmission unit (MTU) of the network.

IP Address. (Internet Protocol address) The address of a computer attached to an IP network. Every client and server station must have a unique IP address. A 32-bit address used by a computer on a IP network. Client workstations have either a permanent address or one that is dynamically assigned to them each session. IP addresses are written as four sets of numbers separated by periods; for example, 204.171.64.2.

IPX/SPX. Internet Package Exchange/Sequential Packet Exchange. A communications protocol for Novell. IPX is Novell's Layer 3 protocol, similar to XNS and IP, and used in NetWare networks. SPX is Novell's version of the Xerox SPP protocol.

IS-95. Interim Standard 95. The EIA/TIA standard that governs the operation of CDMA cellular service. Versions include IS-95A and IS-95B. See CDMA.

K

Key. A key is the specific code used by the algorithm to encrypt or decrypt the data. Also see, **Encryption** and **Decrypting**.

L

LASER. Light Amplification by Stimulated Emission of Radiation. The laser is an intense light source. Light from a laser is all the same frequency, unlike the output of an incandescent bulb. Laser light is typically coherent and has a high energy density.

Laser Diode. A gallium-arsenide semiconductor type of laser connected to a power source to generate a laser beam. This laser type is a compact source of coherent light.

laser scanner. A type of bar code reader that uses a beam of laser light.

LCD. See **Liquid Crystal Display**.

LED Indicator. A semiconductor diode (LED - Light Emitting Diode) used as an indicator, often in digital displays. The semiconductor uses applied voltage to produce light of a certain frequency determined by the semiconductor's particular chemical composition.

Light Emitting Diode. See **LED**.

Liquid Crystal Display (LCD). A display that uses liquid crystal sealed between two glass plates. The crystals are excited by precise electrical charges, causing them to reflect light outside according to their bias. They use little electricity and react relatively quickly. They require external light to reflect their information to the user.

M

MC. Mobile Computer.

MDN. Mobile Directory Number. The directory listing telephone number that is dialed (generally using POTS) to reach a mobile unit. The MDN is usually associated with a MIN in a cellular telephone -- in the US and Canada, the MDN and MIN are the same value for voice cellular users. International roaming considerations often result in the MDN being different from the MIN.

MIL. 1 mil = 1 thousandth of an inch.

MIN. Mobile Identification Number. The unique account number associated with a cellular device. It is broadcast by the cellular device when accessing the cellular system.

Misread (Misdecode). A condition which occurs when the data output of a reader or interface controller does not agree with the data encoded within a bar code symbol.

Mobile Computer. In this text, *mobile computer* refers to the MC70 EDA. It can be set up to run as a stand-alone device, or it can be set up to communicate with a network, using wireless radio technology.

N

Nominal. The exact (or ideal) intended value for a specified parameter. Tolerances are specified as positive and negative deviations from this value.

Nominal Size. Standard size for a bar code symbol. Most UPC/EAN codes are used over a range of magnifications (e.g., from 0.80 to 2.00 of nominal).

NVM. Non-Volatile Memory.

O

ODI. See **Open Data-Link Interface**.

Open Data-Link Interface (ODI). Novell's driver specification for an interface between network hardware and higher-level protocols. It supports multiple protocols on a single NIC (Network Interface Controller). It is capable of understanding and translating any network information or request sent by any other ODI-compatible protocol into something a NetWare client can understand and process.

Open System Authentication. Open System authentication is a null authentication algorithm.

P

PAN . Personal area network. Using Bluetooth wireless technology, PANs enable devices to communicate wirelessly. Generally, a wireless PAN consists of a dynamic group of less than 255 devices that communicate within about a 33-foot range. Only devices within this limited area typically participate in the network.

Parameter. A variable that can have different values assigned to it.

PC Card. A plug-in expansion card for laptop computers and other devices, also called a PCMCIA card. PC Cards are 85.6mm long x 54 mm wide, and have a 68 pin connector. There are several different kinds:

Type I; 3.3 mm high; use - RAM or Flash RAM

Type II; 5 mm high; use - modems, LAN adaptors

Type III; 10.5 high; use - Hard Disks

PCMCIA. Personal Computer Memory Card Interface Association. See **PC Card**.

Percent Decode. The average probability that a single scan of a bar code would result in a successful decode. In a well-designed bar code scanning system, that probability should approach near 100%.

PING. (Packet Internet Groper) An Internet utility used to determine whether a particular IP address is online. It is used to test and debug a network by sending out a packet and waiting for a response.

Print Contrast Signal (PCS). Measurement of the contrast (brightness difference) between the bars and spaces of a symbol. A minimum PCS value is needed for a bar code symbol to be scannable. $PCS = (RL - RD) / RL$, where RL is the reflectance factor of the background and RD the reflectance factor of the dark bars.

Programming Mode. The state in which a scanner is configured for parameter values. See **Scanning Mode**.

Q

Quiet Zone. A clear space, containing no dark marks, which precedes the start character of a bar code symbol and follows the stop character.

QWERTY. A standard keyboard commonly used on North American and some European PC keyboards. "QWERTY" refers to the arrangement of keys on the left side of the third row of keys.

R

RAM. Random Access Memory. Data in RAM can be accessed in random order, and quickly written and read.

Reflectance. Amount of light returned from an illuminated surface.

Resolution. The narrowest element dimension which is distinguished by a particular reading device or printed with a particular device or method.

RF. Radio Frequency.

ROM. Read-Only Memory. Data stored in ROM cannot be changed or removed.

Router. A device that connects networks and supports the required protocols for packet filtering. Routers are typically used to extend the range of cabling and to organize the topology of a network into subnets. See **Subnet**.

RS-232. An Electronic Industries Association (EIA) standard that defines the connector, connector pins, and signals used to transfer data serially from one device to another.

S

Scan Area. Area intended to contain a symbol.

Scanner. An electronic device used to scan bar code symbols and produce a digitized pattern that corresponds to the bars and spaces of the symbol. Its three main components are: 1) Light source (laser or photoelectric cell) - illuminates a bar code; 2) Photodetector - registers the difference in reflected light (more light reflected from spaces); 3) Signal conditioning circuit - transforms optical detector output into a digitized bar pattern.

Scanning Mode. The scanner is energized, programmed and ready to read a bar code.

Scanning Sequence. A method of programming or configuring parameters for a bar code reading system by scanning bar code menus.

SDK. Software Development Kit

Self-Checking Code. A symbology that uses a checking algorithm to detect encoding errors within the characters of a bar code symbol.

Shared Key. Shared Key authentication is an algorithm where both the AP and the MU share an authentication key.

SHIP. Symbol Host Interface Program.

SID. System Identification code. An identifier issued by the FCC for each market. It is also broadcast by the cellular carriers to allow cellular devices to distinguish between the home and roaming service.

Soft Reset. See **Warm Boot.**

Space. The lighter element of a bar code formed by the background between bars.

Specular Reflection. The mirror-like direct reflection of light from a surface, which can cause difficulty decoding a bar code.

Start/Stop Character. A pattern of bars and spaces that provides the scanner with start and stop reading instructions and scanning direction. The start and stop characters are normally to the left and right margins of a horizontal code.

STEP. Symbol Terminal Enabler Program.

Subnet. A subset of nodes on a network that are serviced by the same router. See **Router.**

Subnet Mask. A 32-bit number used to separate the network and host sections of an IP address. A custom subnet mask subdivides an IP network into smaller subsections. The mask is a binary pattern that is matched up with the IP address to turn part of the host ID address field into a field for subnets. Default is often 255.255.255.0.

Substrate. A foundation material on which a substance or image is placed.

SVTP. Symbol Virtual Terminal Program.

Symbol. A scannable unit that encodes data within the conventions of a certain symbology, usually including start/stop characters, quiet zones, data characters and check characters.

Symbol Aspect Ratio. The ratio of symbol height to symbol width.

Symbol Height. The distance between the outside edges of the quiet zones of the first row and the last row.

Symbol Length. Length of symbol measured from the beginning of the quiet zone (margin) adjacent to the start character to the end of the quiet zone (margin) adjacent to a stop character.

Symbology. The structural rules and conventions for representing data within a particular bar code type (e.g. UPC/EAN, Code 39, PDF417, etc.).

T

TCP/IP. (Transmission Control Protocol/Internet Protocol) A communications protocol used to internetwork dissimilar systems. This standard is the protocol of the Internet and has become the global standard for communications. TCP provides transport functions, which ensures that the total amount of bytes sent is received correctly at the other end.

UDP is an alternate transport that does not guarantee delivery. It is widely used for real-time voice and video transmissions where erroneous packets are not retransmitted. IP provides the routing mechanism. TCP/IP is a routable protocol, which means that all messages contain not only the address of the destination station, but the address of a destination network. This allows TCP/IP messages to be sent to multiple networks within an organization or around the world, hence its use in the worldwide Internet. Every client and server in a TCP/IP network requires an IP address, which is either permanently assigned or dynamically assigned at startup.

Telnet. A terminal emulation protocol commonly used on the Internet and TCP/IP-based networks. It allows a user at a terminal or computer to log onto a remote device and run a program.

Terminal. See **Mobile Computer**.

Terminal Emulation. A "terminal emulation" emulates a character-based mainframe session on a remote non-mainframe terminal, including all display features, commands and function keys. The VC5000 Series supports Terminal Emulations in 3270, 5250 and VT220.

Terminate and Stay Resident (TSR). A program under DOS that ends its foreground execution to remain resident in memory to service hardware/software interrupts, providing background operation. It remains in memory and may provide services on behalf of other DOS programs.

TFTP. (Trivial File Transfer Protocol) A version of the TCP/IP FTP (File Transfer Protocol) protocol that has no directory or password capability. It is the protocol used for upgrading firmware, downloading software and remote booting of diskless devices.

Tolerance. Allowable deviation from the nominal bar or space width.

Transmission Control Protocol/Internet Protocol. See **TCP/IP**.

Trivial File Transfer Protocol. See **TFTP**.

TSR. See **Terminate and Stay Resident**.

U

UDP. User Datagram Protocol. A protocol within the IP protocol suite that is used in place of TCP when a reliable delivery is not required. For example, UDP is used for real-time audio and video traffic where lost packets are simply ignored, because there is no time to retransmit. If UDP is used and a reliable delivery is required, packet sequence checking and error notification must be written into the applications.

UPC. Universal Product Code. A relatively complex numeric symbology. Each character consists of two bars and two spaces, each of which is any of four widths. The standard symbology for retail food packages in the United States.

V

Visible Laser Diode (VLD). A solid state device which produces visible laser light.

W

Warm Boot. A warm boot restarts the mobile computer by closing all running programs. All data that is not saved to flash memory is lost.

Index

Numerics

802.11 ESSID 7-5

A

accessories 1-2
 auto charge cable 1-2
 cables 1-2, 2-27
 communication/charge cables 2-27
 battery charging 2-28
 LED indicators 2-28
 cradle 2-1
 DEX cable 1-2
 EMDK 1-2
 four slot Ethernet cradle 1-2, 2-1, 2-6
 four slot spare battery charger 1-2, 2-1, 2-20
 headset 1-2, 2-1, 2-2
 holster, quick release 1-2
 magnetic stripe reader 1-2, 2-2
 MMC 2-1, 2-2
 mounting bracket 2-11
 MSR 2-23
 installation 2-23
 magnetic stripe reading 2-23
 multi media card 1-2
 printer cable 1-2
 rigid case 2-1
 SD card 2-1, 2-2
 shelf slide 1-2
 SIM card 1-9
 single slot USB serial cradle 2-4
 snap on cable 1-2
 snap-on handle 1-2
 spare battery 1-2
 specifications A-4
 stylus 1-2

 trigger handle 2-2, 2-24
 USB cable 1-2
 USB charger cable 1-2
 USB cradle 1-2
 vehicle cradle 1-2, 2-1, 2-12
 wall mounting kit, cradle 1-2

activation

 Sprint CDMA 6-2, 6-4
 Verizon CDMA 6-4, 6-6

ActiveSync

 deploying CAB files 4-4
 installing 3-1
 setting up a connection 3-2

ad-hoc

ad-hoc networks 7-34

Advanced Encryption Standard 7-16

AES

AES 7-16

AirBEAM

 deploying CAB files 4-5

AP networks 7-34

APN 5-3

application deployment 4-1, 4-4

 CAB files 4-4

application folder 4-9

application packaging 4-4

application security 4-1

authentication

 EAP-TLS 7-9

 LEAP 7-9

 none 7-9

 PEAP 7-9

auto charge cable 1-2

B

backup battery
 charging 1-5

- battery
 - backup charging 1-5
 - charging 1-5
 - charging main battery 1-5
 - installing 1-3
 - removing 1-4
 - spare charging 1-6
- battery chargers
 - communication/charge cables 2-27
 - battery charging 2-28
 - LED indicators 2-28
 - four slot 2-20
- battery charging
 - communication/charge cables 2-28
 - battery charging 2-28
 - four slot Ethernet cradle 2-10
 - single slot cradle 2-4
 - spare 2-21
 - temperature 1-7
 - vehicle cradle 2-17
- bluetooth
 - ad-hoc mode 7-7
 - troubleshooting 8-4
- boot
 - clean 1-8
 - cold 1-7, 5-16
 - warm 1-7, 5-16
- bullets xviii

C

- CAB files 4-4, 4-7, 4-10
 - deployment via ActiveSync 4-4
 - deployment via AirBEAM 4-5
 - deployment via image update 4-5
 - deployment via storage card 4-4
- cables 1-2, 2-1, 2-27
 - auto charge cable 1-2
 - charging 2-27
 - communication 2-27
 - communication setup 2-28
 - DEX cable 1-2
 - pinouts A-7
 - printer cable 1-2
 - setup 2-27
 - troubleshooting 8-8
 - USB charger 1-2
- cache disk 4-9
- calibrating the screen 1-7
- call barring 6-15
- call blocking See call barring 5-10
- call forwarding 5-10, 6-15
- call waiting 5-11, 6-16
- caller id 5-10, 6-15

- CDMA
 - activate Sprint 6-2
 - activate Verizon 6-4
 - activate Verizon automated 6-4
 - data connection 6-7
 - settings
 - data, Sprint 6-9
 - data, Verizon 6-11
 - location 6-9
 - phone 6-8
 - phone info 6-14
 - provisioning 6-4, 6-10
 - services 6-15, 6-16
 - system, Sprint 6-12
 - system, Verizon 6-13, 6-14
 - test Sprint activation 6-4
 - test Verizon activation 6-6
- certificates 4-3
- changing a PIN for phone use 5-8
- charging
 - communication/charge cables 2-28
 - four slot Ethernet cradle 2-10
 - single slot cradle 2-4
 - spare batteries 2-21
 - temperature 1-7
 - vehicle cradle 2-17
- charging batteries 1-5
- charging spare batteries 1-6
- charging temperature 1-7
- clean boot 1-8
- cleaning 8-1
- cold boot 1-7, 5-16
- communication
 - charge cables 2-27
- communication setup
 - communication/charge cables 2-28
- communication/charge cables
 - battery charging 2-28
 - communication setup 2-28
 - LED indicators 2-28
- configuration xiv, 1-3
- conventions
 - notational xviii
- copyfile 4-8
- country code 7-7
- cpf file 4-7, 4-10
- cradles
 - daisy chaining 2-7
 - Ethernet drivers 2-8
 - four slot Ethernet 1-2, 2-1, 2-6
 - charging 2-10
 - charging indicators 2-10
 - setup 2-6
 - four slot spare battery charger 2-1, 2-20

- charging 2-21
- charging indicators 2-22
- setup 2-21
- mounting bracket 2-11
- single slot USB serial 2-1, 2-4
 - charging indicators 2-5
 - setup 2-4
- troubleshooting 8-6, 8-7, 8-8
- USB 1-2
- vehicle 1-2, 2-1, 2-12
 - charging 2-17
 - charging indicators 2-19
 - setup 2-14
- creating cpf file 4-7
 - SCM 4-10
- creating splash screen 4-6

D

- data capturexiv
- data connection 5-3, 6-7
- default gateway 7-18
- deployment 4-1, 4-4
 - CAB files 4-4
 - file 4-13
- DEX cable 1-2
- DHCP 7-18
- digital signatures 4-1
- disabling PIN for phone use 5-9
- disconnecting 5-6
- displayxiv
- DNS 7-18, 7-19

E

- EAP-TLS 7-9
- EDA configuration 1-3
- EMDK xviii, 4-13
- enabling PIN for phone use 5-8
- encryption
 - open system 7-16, 7-18
 - TKIP (WPA) 7-16
- Enterprise Mobility Developer Kit xviii, 1-2, 4-13
- ESD 2-2
- Ethernet cradle 1-2

F

- file deployment 4-13
- flash card 1-2
- flash file system
 - copyfile 4-8
 - regmerge 4-7
- four slot Ethernet cradle 2-1, 2-6

- charging 2-10
- charging indicators 2-10
- daisy chaining 2-7
- drivers 2-8
- link indicator 2-10
- setup 2-6
- speed indicator 2-10
- troubleshooting 8-7
- four slot spare battery charger 1-2, 2-1, 2-20
 - charging 2-21
 - charging indicators 2-22
 - setup 2-21
 - shim installation 2-20
 - troubleshooting 8-8

G

- gateway 7-19
- GPRS
 - data connection 5-2, 5-3, 5-5
 - data disconnect 5-6
 - registry file 5-3
 - settings
 - services 6-15
 - WAN configuration 5-3
- GSM
 - access point name 5-3
 - configure GPRS data connection 5-2, 5-3
 - ensuring network coverage 5-1, 5-2
 - GPRS data connection 5-5
 - settings
 - band 5-16
 - networks 5-12
 - phone 5-7
 - phone info 5-15
 - PIN 5-8, 5-9
 - security 5-8
 - services 5-9, 5-10, 5-11
 - sound 5-8

H

- hard reset 1-7, 1-8
- headset 1-2, 2-1, 2-2
- holster 1-2

I

- image update
 - deploying CAB files 4-5
- information, service xix
- infrastructure 7-7
- installing battery 1-3
- internet

- disconnecting GPRS 5-6
 - via GPRS 5-5
 - wireless connection 5-3, 6-7
- IP address 7-18
- IP config
 - DNS 7-19
 - gateway 7-19
 - IP address 7-18
 - subnet mask 7-18
 - WINS 7-19

K

- keypadsxiv

L

- LEAP 7-9
- lithium-ion battery 1-1
- locking EDA 1-9, 4-2

M

- magnetic stripe reader 1-2, 2-2, 2-23
 - installation 2-23
 - magnetic stripe reading 2-23
 - troubleshooting 8-9
- main battery
 - charging 1-3, 6-1
 - installing 1-3, 6-1
- maintenance 8-1
- memoryxiv
- MMC 1-2, 2-1, 2-2
- mode
 - 802.11 ESSID 7-5
 - ad-hoc 7-7
 - country 7-7
 - infrastructure 7-7
 - operating 7-7
 - profile name 7-5
- Monarch printer cable 2-27
- mounting bracket 2-11
- MSR 1-2, 2-2, 2-23
 - installation 2-23
 - magnetic stripe reading 2-23
 - troubleshooting 8-9
- multi media card 1-2, 2-1, 2-2

N

- network
 - configuring GPRS WAN 5-3
 - GSM 5-12
- network coverage, GSM 5-1, 5-2

O

- O'Neil printer cable 2-27
- open system 7-16, 7-18
- operating environment A-1
- operating mode 7-7
- operating system xiv

P

- packaging 4-4
- PEAP 7-9
- persistent storage 4-9
- phone
 - activation 6-2, 6-4
- phone security 5-8, 5-9
- phone settings 5-7
- PIN, changing for phone 5-8
- PIN, disabling for phone use 5-9
- PIN, enabling for phone use 5-8
- pinouts A-7
- powering on EDA 1-7
- printer cable 1-2
- profile
 - create new 7-23
 - delete 7-23
 - edit 7-23
 - name 7-5
- provisioning 6-4, 6-10

Q

- quick release holster 1-2

R

- radios xiv
- RAM 4-9
- random access memory 4-9
- RAPI 4-3
- regmerge 4-7
- remote API 4-3
- removing main battery 1-4
- reset
 - hard 1-7, 1-8
 - soft 1-7
- rigid case 2-1
- RS232 charge cable 2-27

S

- SCM 4-10
 - file deployment 4-13
 - file types 4-10

- menu 4-11
 - parameter indicators 4-12
 - user interface 4-10
 - XML provisioning 4-10
 - screen
 - calibration 1-7
 - splash window 1-7
 - SD 2-1, 2-2
 - SDK
 - See EMDK 1-2
 - secure digital card 2-1, 2-2
 - security 4-1
 - application 4-1
 - certificates 4-3
 - device management 4-3
 - digital signatures 4-1
 - locking device 4-2
 - remote API 4-3
 - serial charge cable 2-27
 - service information xix
 - services, CDMA
 - call barring 6-15
 - call forwarding 6-15
 - call waiting 6-16
 - caller id 6-15
 - SMS 6-16
 - voice mail 6-16
 - services, GSM
 - call barring 5-10
 - call forwarding 5-10
 - call waiting 5-11
 - caller id 5-10
 - text messages 5-11
 - voice mail 5-11
 - settings
 - CDMA 6-2, 6-8
 - GSM 5-2
 - GSM/GPRS 5-7
 - shelf slide 1-2
 - shim installation 2-20
 - short message service 6-16
 - signal strength 7-26
 - SIM card
 - accessories 1-9
 - activation 5-2
 - install 1-9, 5-1
 - network access 5-12
 - single slot USB serial cradle 2-4
 - charging 2-4
 - charging indicators 2-5
 - troubleshooting 8-6
 - SMS 6-16
 - snap-on handle 1-2
 - soft reset 1-7
 - spare battery 1-2
 - charging 1-6
 - spare battery charger 2-1
 - charging 2-21
 - charging indicators 2-22
 - setup 2-21
 - splash screen
 - creating 4-6
 - Sprint phone activation 6-2, 6-4
 - starting EDA 1-3, 1-7
 - starting the mobile computer 6-1
 - storage 4-8
 - application folder 4-9
 - cache disk 4-9
 - persistent 4-9
 - volatile 4-9
 - storage card
 - deploying CAB files 4-4
 - strap 1-1
 - stylus 1-1, 1-2
 - subnet mask 7-18
 - subscriber identification module 1-9
 - suspend 1-4
 - Symbol configuration manager 4-10
 - file deployment 4-13
 - file types 4-10
 - menu 4-11
 - parameter indicators 4-12
 - user interface 4-10
 - XML provisioning 4-10
- ## T
- technical specifications A-1
 - accessories A-4
 - text messages 5-11
 - TKIP (WPA) 7-16
 - TRG7000 2-2
 - trigger handle 2-2, 2-24
 - charging with 2-26
 - installing 2-24
 - troubleshooting 8-2
 - bluetooth 8-4
 - cables 8-8
 - EDA 8-2
 - four slot Ethernet cradle 8-7
 - four slot spare battery charger 8-8
 - MSR 8-9
 - single slot USB serial cradle 8-6
 - vehicle cradle 8-7
- ## U
- unpacking 1-1

USB cable 1-2
USB charger 1-2
USB client charge cable 2-27
USB cradle 1-2

V

vehicle cradle 1-2, 2-1, 2-12
 charging indicators 2-19
 troubleshooting 8-7
Verizon phone activation 6-4, 6-6
voice mail 5-11, 6-16
volatile storage 4-9

W

wall mount bracket 1-2, 2-11
warm boot 1-7, 5-16
WINS 7-18, 7-19
wireless
 internet 5-3, 6-7
WLAN 802.11a/b/g xiv, xv
WPAN Bluetooth xiv, xv
WWAN
 configuring GPRS 5-3

X

XML provisioning 4-6, 4-7
 certificates 4-3
 SCM 4-10

Z

Zebra printer cable 2-27



Zebra Technologies Corporation
Lincolnshire, IL U.S.A.
<http://www.zebra.com>

Zebra and the stylized Zebra head are trademarks of ZIH Corp., registered in many jurisdictions worldwide. All other trademarks are the property of their respective owners.

©2015 ZIH Corp and/or its affiliates. All rights reserved.