

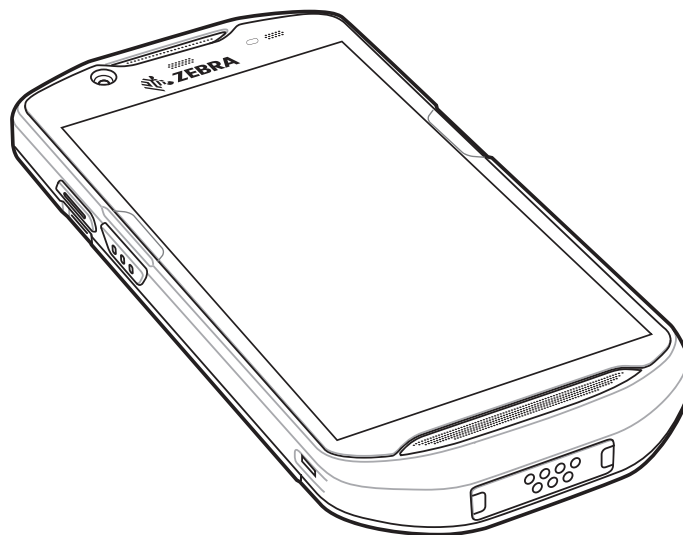

TC51



Touch Computer

User Guide for Android™ Version 6.0.1



TC51 USER GUIDE FOR ANDROID VERSION 6.0.1

MN-002868-04

Rev. A

July 2017

No part of this publication may be reproduced or used in any form, or by any electrical or mechanical means, without permission in writing from Zebra. This includes electronic or mechanical means, such as photocopying, recording, or information storage and retrieval systems. The material in this manual is subject to change without notice.

The software is provided strictly on an “as is” basis. All software, including firmware, furnished to the user is on a licensed basis. Zebra grants to the user a non-transferable and non-exclusive license to use each software or firmware program delivered hereunder (licensed program). Except as noted below, such license may not be assigned, sublicensed, or otherwise transferred by the user without prior written consent of Zebra. No right to copy a licensed program in whole or in part is granted, except as permitted under copyright law. The user shall not modify, merge, or incorporate any form or portion of a licensed program with other program material, create a derivative work from a licensed program, or use a licensed program in a network without written permission from Zebra. The user agrees to maintain Zebra’s copyright notice on the licensed programs delivered hereunder, and to include the same on any authorized copies it makes, in whole or in part. The user agrees not to decompile, disassemble, decode, or reverse engineer any licensed program delivered to the user or any portion thereof.

Zebra reserves the right to make changes to any software or product to improve reliability, function, or design.

Zebra does not assume any product liability arising out of, or in connection with, the application or use of any product, circuit, or application described herein.

No license is granted, either expressly or by implication, estoppel, or otherwise under any Zebra Technologies Corporation, intellectual property rights. An implied license only exists for equipment, circuits, and subsystems contained in Zebra products.

Revision History

Changes to the original guide are listed below:

Change	Date	Description
-01 Rev. A	11/2016	Initial release.
-02 Rev. A	01/2017	Add Google trademark requirements.
-03 Rev. A	05/2017	Add TC51-HC (Healthcare) configuration.
-04 Rev. A	07/2017	Supports software update for BSP 19-01.4.

TABLE OF CONTENTS

Revision History	iii
------------------------	-----

About This Guide

Introduction	li
Documentation Set	li
Configurations	li
Software Versions	lii
Chapter Descriptions	lii
Notational Conventions	liii
Icon Conventions	liii
Related Documents	liii
Service Information	liv
Provide Documentation Feedback	liv

Chapter 1: Getting Started

Unpacking	1-1
Features	1-2
Setup	1-4
Installing a microSD Card	1-4
Installing the Battery	1-7
Charging the Battery	1-7
Charging Indicators	1-8
Google Account Setup	1-8
Replacing the Battery	1-8
Replacing the microSD Card	1-10
Accessing Device Settings	1-11
Battery Management	1-11
Monitor Battery Usage	1-11
Low Battery Notification	1-12
Battery Optimization	1-13
Turning Off the Radios	1-13
Setting the Date and Time	1-13

Display Setting	1-14
Setting the Screen Brightness	1-14
Setting Screen Rotation	1-14
Setting Home Screen Rotation	1-14
Setting Screen Timeout Setting	1-15
Setting Font Size	1-15
Touch Panel Mode	1-16
Setting Notification LED	1-17
General Sound Setting	1-17
Wake-Up Sources	1-19

Chapter 2: Using the TC51

Introduction	2-1
Google Mobile Services	2-1
Home Screen	2-2
Status Bar	2-3
Status Icons	2-4
Notification Icons	2-4
Managing Notifications	2-5
Application Shortcuts and Widgets	2-6
Adding an Application to the Home Screen	2-6
Adding a Widget to the Home Screen	2-7
Moving Items on the Home Screen	2-7
Removing an Application Shortcut or Widget from the Home Screen	2-7
Folders	2-7
Creating a Folder	2-7
Naming Folders	2-7
Removing a Folder	2-8
Home Screen Wallpaper	2-8
Using the Touchscreen	2-8
Keyboards	2-9
Keyboard Configuration	2-9
Using the Enterprise Keyboard	2-9
Numeric Tab	2-9
Alpha Tab	2-10
Additional Character Tab	2-10
Scan Tab	2-11
Using the Android Keyboard	2-11
Editing Text	2-11
Entering Numbers, Symbols and Special Characters	2-11
Applications	2-13
Accessing Applications	2-17
Switching Between Recent Applications	2-17
Un-Locking the Screen	2-18
Resetting the Device	2-22
Performing a Soft Reset	2-22
Performing a Hard Reset	2-22
Suspend Mode	2-23
Transferring Files with a Host Computer via USB	2-23

Transferring Files using Media Transfer Protocol	2-24
Transferring Files using Photo Transfer Protocol	2-24
Disconnect from the Host Computer	2-25
Chapter 3: Applications	
ActiveEdge Touch Zone	3-1
Battery Manager	3-5
File Browser	3-8
Contacts	3-9
Adding a Contact	3-9
Editing Contacts	3-9
Deleting Contacts	3-9
Camera	3-10
Taking Photos	3-10
Taking a Panoramic Photo	3-11
Recording Videos	3-12
Photo Settings	3-13
Video Settings	3-13
Gallery	3-15
Working with Albums	3-16
Share an Album	3-17
Get Album Information	3-17
Deleting an Album	3-17
Working with Photos	3-18
Viewing and Browsing Photos	3-18
Cropping a Photo	3-19
Setting a Photo as a Contact Icon	3-19
Share a Photo	3-20
Deleting a Photo	3-20
Working with Videos	3-20
Watching Videos	3-20
Sharing a Video	3-20
Deleting a Video	3-20
DataWedge Demonstration	3-22
Sound Recorder	3-24
PTT Express Voice Client	3-25
PTT Audible Indicators	3-25
Notification Icons	3-26
Enabling PTT Communication	3-27
Selecting a Talk Group	3-27
PTT Communication	3-27
Creating a Group Call	3-28
Responding with a Private Response	3-28
Disabling PTT Express Voice Client Communication	3-28
RxLogger	3-29
SimulScan Demo	3-30
Exporting Sample Forms	3-30
Postal, Transportation and Logistics Example	3-31
Manufacturing Example	3-33

Settings	3-35
Advanced Settings	3-36
Demo Customization	3-37
Default Templates	3-38
Elemesz	3-40
Disabling Elemesz Data Collection	3-40
Enabling Elemesz Data Collection	3-41

Chapter 4: Data Capture

Imaging	4-1
Operational Modes	4-1
RS507 Hands-Free Imager	4-2
RS6000 Bluetooth Ring Scanner	4-2
DS3678 Digital Scanner	4-2
Scanning Considerations	4-3
Bar Code Scanning with Internal Imager	4-3
Bar Code Capture with RS6000 Bluetooth Ring Scanner	4-5
Bar Code Capture with RS507 Hands-Free Imager	4-6
Bar Code Capture with DS3678 Bluetooth Scanner	4-7
Pairing the RS507/RS6000 Hands-Free Imager	4-8
Pairing Using Near Field Communication	4-9
Pairing in HID Mode Using Near Field Communication	4-9
Pairing Using Simple Serial Interface	4-11
Pairing Using Bluetooth Human Interface Device	4-11
Pairing the DS3678 Digital Scanner	4-12
Pairing Using Simple Serial Interface	4-12
Pairing Using Bluetooth Human Interface Device	4-13
DataWedge	4-14
Enabling DataWedge	4-14
Disabling DataWedge	4-14

Chapter 5: Wireless

Wireless Local Area Networks	5-1
Scan and Connect to a Wi-Fi Network	5-1
Remove a Wi-Fi Network	5-3
Bluetooth	5-4
Adaptive Frequency Hopping	5-4
Security	5-4
Bluetooth Profiles	5-5
Bluetooth Power States	5-5
Bluetooth Radio Power	5-6
Enabling Bluetooth	5-6
Disabling Bluetooth	5-6
Discovering Bluetooth Device(s)	5-6
Changing the Bluetooth Name	5-6
Connecting to a Bluetooth Device	5-7
Unpairing a Bluetooth Device	5-7
Near Field Communications	5-8

Reading NFC Cards	5-8
Sharing Information Using NFC	5-9
Chapter 6: Accessories	
Accessories	6-1
1-Slot USB Charge Cradle	6-5
Charging the Device	6-5
Inserting a TC51 with Rugged Boot into Cradle	6-6
Battery Charging	6-7
Charging Temperature	6-7
4-Slot Charge Only Cradle with Battery Charger	6-8
Charging the TC51	6-8
Inserting a TC51 with Rugged Boot into Cradle	6-10
Battery Charging	6-10
Main Battery Charging	6-10
Spare Battery Charging	6-10
Charging Temperature	6-11
5-Slot Charge Only Cradle	6-12
Charging the TC51	6-12
Inserting a TC51 with Rugged Boot into Cradle	6-13
Battery Charging	6-14
Charging Temperature	6-14
5-Slot Ethernet Cradle	6-15
Charging the TC51	6-15
Inserting a TC51 with Rugged Boot into Cradle	6-16
Battery Charging	6-16
Charging Temperature	6-17
Establishing Ethernet Connection	6-17
LED Indicators	6-17
4-Slot Battery Charger	6-18
Charging Spare Batteries	6-18
Battery Charging	6-19
Spare Battery Charging	6-19
Charging Temperature	6-19
Rugged Boot	6-20
Installation	6-20
Installing Stylus	6-21
Charging with Cradles	6-22
Basic Hand Strap Kit	6-24
Installation 24	
Removal	6-25
2.5 mm Audio Adapter	6-27
3.5 mm Audio Adapter	6-29
Rugged Charge/USB Cable	6-31
Connecting to TC51	6-31
Connecting to TC51 with Rugged Boot	6-32
USB Communication	6-33
Charging the Device	6-33
Disconnecting the Rugged Charge/USB Cable	6-34

Battery Charging	6-35
Main Battery Charging	6-35
Charging Temperature	6-35
Trigger Handle	6-36
Installing the Rugged Boot	6-36
Installing the Optional Lanyard	6-38
Inserting the Device into the Trigger Handle	6-39
Removing the Device from the Trigger Handle	6-40
Power Supply	6-42

Chapter 7: Maintenance and Troubleshooting

Maintaining the TC51	7-1
Display Best Practices	7-2
Image Retention	7-2
Battery Safety Guidelines	7-2
Cleaning Instructions	7-3
Approved Cleanser Active Ingredients	7-3
Approved Disinfectant Cleaners for TC51-Healthcare	7-4
Harmful Ingredients	7-4
Cleaning Instructions	7-4
Special Cleaning Notes	7-4
Recommended Cleaning Materials	7-5
TC51-Standard and Healthcare	7-5
TC51-Healthcare Only	7-5
Cleaning Frequency	7-5
Cleaning the TC51	7-5
Housing	7-5
Display	7-5
Camera and Exit Window	7-5
Battery Guide Slots	7-6
Battery Connector and Locating Magnet Cleaning	7-6
Cleaning Cradle Connectors	7-7
Troubleshooting	7-8
TC51	7-8

Appendix A: Technical Specifications

TC51	A-1
------------	-----

Index

ABOUT THIS GUIDE

Introduction

This guide provides information about using the TC51 mobile computer and accessories. The TC51 refers to both the TC51 (Standard) and TC51-HC (Healthcare) configurations, except where noted.



NOTE Screens and windows pictured in this guide are samples and can differ from actual screens.

Documentation Set

The documentation set for the TC51 provides information for specific user needs, and includes:

- *TC51 Touch Computer Quick Start Guide* - describes how to get the TC51 up and running.
- *TC51 Touch Computer User Guide for Android Version 6.0.1* - describes how to use the TC51.
- *TC51 Touch Computer Integrator Guide for Android Version 6.0.1* - describes how to set up the TC51 and accessories.

Configurations

This guide covers the following configurations:

Configuration	Radios	Display	Memory	Data Capture Options	Operating System
TC510K-1	WLAN: 802.11 a/b/g/n/d/h/i/k/r WPAN: Bluetooth v4.1 Low Energy	5.0" High Definition (1280 x 720) LCD	2 GB RAM / 16 GB Flash or 4 GB RAM / 32 GB Flash	2D imager (SE-4710) and integrated NFC	Android-based, Google™ Mobile Services (GMS) 6.0.1.
TC510K-2	WLAN: 802.11 a/b/g/n/d/h/i/k/r WPAN: Bluetooth v4.1 Low Energy	5.0" High Definition (1280 x 720) LCD	2 GB RAM / 16 GB Flash or 4 GB RAM / 32 GB Flash	2D imager (SE-4710) and integrated NFC	Android-based, Android Open-Source Project 6.0.1

Software Versions

To determine the current software versions, swipe down with two fingers from the status bar to open the quick access panel and then touch .

Touch  **About phone**.

- **Model number**- Displays the model number.
- **Android version** - Displays the operating system version.
- **Kernel version** - Displays the kernel version number.
- **Build number** - Displays the software build number.

To determine the device serial number, touch  **About phone > Status**.

- **Serial number** - Displays the serial number.

Chapter Descriptions

Topics covered in this guide are as follows:

- [Chapter 1, Getting Started](#) provides information on getting the TC51 up and running for the first time.
- [Chapter 2, Using the TC51](#) provides information for operating the TC51.
- [Chapter 3, Applications](#) provides information on using applications installed on the TC51.
- [Chapter 4, Data Capture](#) provides information for capturing bar code data using the imager.
- [Chapter 5, Wireless](#) provides information on the various wireless options.
- [Chapter 6, Accessories](#) provides information for using the accessories for the TC51.
- [Chapter 7, Maintenance and Troubleshooting](#) includes instructions on cleaning and provides troubleshooting solutions for potential problems during TC51 operation.
- [Appendix A, Technical Specifications](#) provides the technical specifications for the TC51.

Notational Conventions

The following conventions are used in this document:

- *Italics* are used to highlight the following:
 - Chapters and sections in this and related documents
 - Icons on a screen.
- **Bold** text is used to highlight the following:
 - Dialog box, window, and screen names
 - Drop-down list and list box names
 - Check box and radio button names
 - Button names on a screen.
- Bullets (•) indicate:
 - Action items
 - Lists of alternatives
 - Lists of required steps that are not necessarily sequential
- Sequential lists (for example, lists that describe step-by-step procedures) appear as numbered lists.

Icon Conventions

The documentation set is designed to give the reader more visual clues. The following graphic icons are used throughout the documentation set. These icons and their associated meanings are described below.



WARNING! The word **WARNING** with the associated safety icon implies information that, if disregarded, could result in death or serious injury, or serious product damage.



CAUTION The word **CAUTION** with the associated safety icon implies information that, if disregarded, may result in minor or moderate injury, or serious product damage.



NOTE NOTE contains information more important than the surrounding text, such as exceptions or preconditions. They also refer the reader elsewhere for additional information, remind the reader how to complete an action (when it is not part of the current procedure, for instance), or tell the reader where something is located on the screen. There is no warning level associated with a note.

Related Documents

- *TC51 Touch Computer Quick Start Guide*, p/n MN-002859-xx.
- *TC51 Touch Computer Regulatory Guide*, p/n MN002860-xx.
- *TC51 Touch Computer Integrator Guide for Android Version 6.0.1*, p/n MN002869-xx.
- *RS507 Hands-free Imager Product Reference Guide*, p/n 72E-12082-xx.
- *DS36X8 Product Reference Guide*, p/n MN-002689-xx.

- RS6000 User Guide, MN-002704-xx.

For the latest version of this guide and all guides, go to: <http://www.zebra.com/support>.

Service Information

If you have a problem with the equipment, contact Customer Support in the region. Contact information is available at: <http://www.zebra.com/support>.

When contacting support, please have the following information available:

- Serial number of the unit (found on manufacturing label)
- Model number or product name (found on manufacturing label)
- Software type and version number

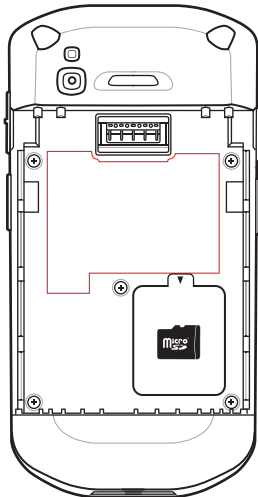

Customer Support responds to calls by email or telephone within the time limits set forth in support agreements.

If the problem cannot be solved by Customer Support, the user may need to return the equipment for servicing and will be given specific directions. We are not responsible for any damages incurred during shipment if the approved shipping container is not used. Shipping the units improperly can possibly void the warranty. Remove the microSD card from the device before shipping for service.

If the device was purchased from a business partner, contact that business partner for support.

Provide Documentation Feedback

If you have comments, questions, or suggestions about this guide, send an email to EVM-Techdocs@zebra.com.

CHAPTER 1 GETTING STARTED

This chapter provides information for getting the device up and running for the first time.

Unpacking

1. Carefully remove all protective material from the TC51 and save the shipping container for later storage and shipping.
2. Verify that the following were received:
 - TC51 mobile computer
 - 4,300 mAh (typical) / 4,050 mAh (minimum) PowerPrecision+ Lithium-ion battery
 - Regulatory Guide.
3. Inspect the equipment for damage. If any equipment is missing or damaged, contact the Global Customer Support center immediately.
4. Prior to using the TC51 for the first time, remove the protective shipping film that covers the scan window, display and camera window.

Features



NOTE All features are available on both the TC51 (Standard) and TC51-HC (Healthcare) configurations, except where noted.

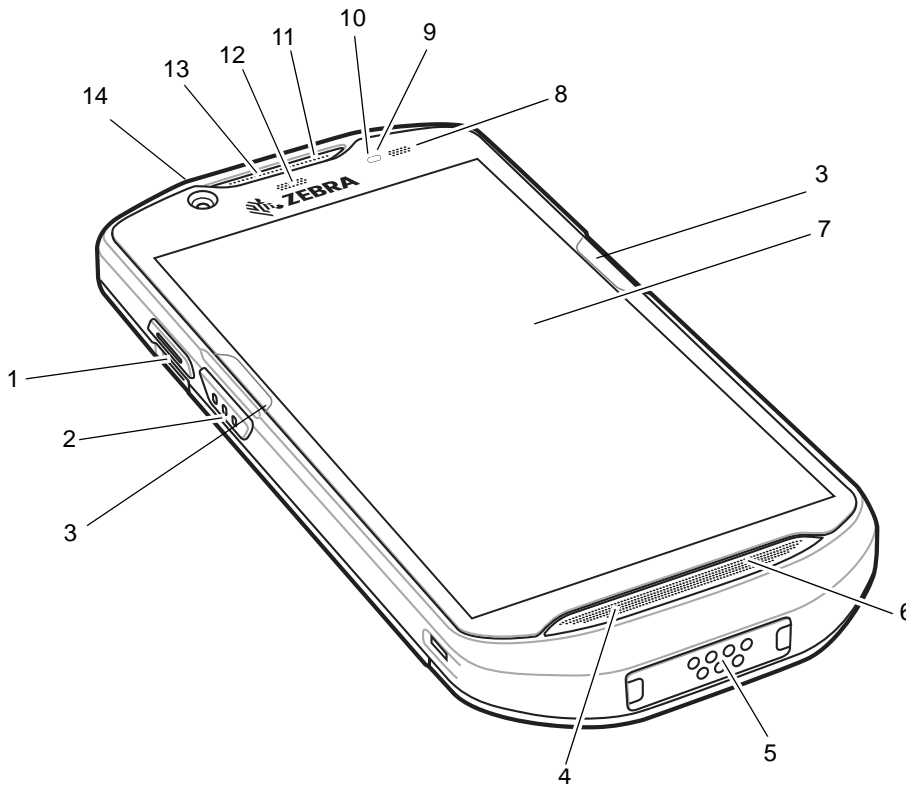

Figure 1-1 TC51 Front View

Table 1-1 Front View Features

Number	Item	Function
1	PTT Button	Initiates push-to-talk communications (programmable).
2	Scan Button	Initiates data capture (programmable).
3	ActiveEdge Touch Zone	Programmable dynamic soft key positioned near the perimeter of the display for one-touch access to a frequently used application or function. Available on builds BSP 19-01.4 and above.
4	Microphone	Use for communications in Handset mode.
5	Interface Connector	Provides USB host and client communications, audio and device charging via cables and accessories. CAUTION: Do not remove the interface connector to ensure proper device sealing.

Table 1-1 Front View Features (Continued)

Number	Item	Function
6	Speaker	Provides audio output for video and music playback. Provides audio in speakerphone mode.
7	Touch Screen	Displays all information needed to operate the TC51.
8	Charging/Notification LED	Indicates battery charging status while charging and application generated notifications.
9	Light Sensor	Determines ambient light for controlling display backlight intensity.
10	Proximity Sensor	Determines proximity for turning off display when in handset mode.
11	Microphone	Use for communications in Speakerphone mode.
12	Data Capture LED	Indicates data capture status.
13	Receiver	Use for audio playback in Handset mode.
14	Front Camera	(TC51-HC) Takes photos and videos.

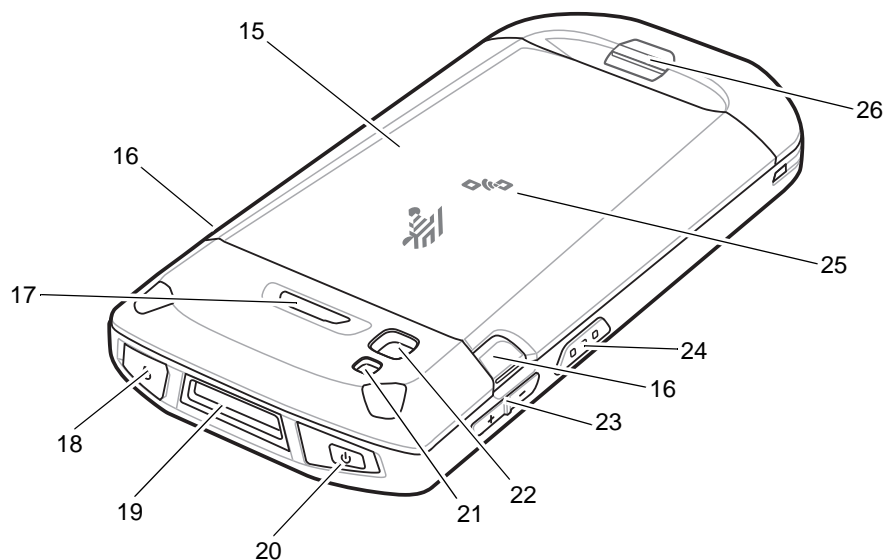
**Figure 1-2** TC51 Rear View**Table 1-2** Back View Features

Number	Item	Function
15	Battery	Provides power to the device.
16	Battery Release Latches	Press to remove the battery.
17	Programmable Button	Programmable.
18	Headset Jack	(TC51 Standard) For audio output to headset.
19	Exit Window	Provides data capture using the imager.

Table 1-2 Back View Features (Continued)

Number	Item	Function
20	Power Button	Turns the display on and off. Press and hold to reset the device, power off or swap battery.
21	Camera Flash	Provides illumination for the camera.
22	Rear Camera	Takes photos and videos.
23	Volume Up/Down Button	Increase and decrease audio volume (programmable).
24	Scan Button	Initiates data capture (programmable).
25	NFC Antenna	Provides communication with other NFC-enabled devices.
26	Basic Hand Strap Mount	(TC51 Standard) Provides mounting point for Basic Hand Strap accessory.

Setup

Perform this procedure to start using the TC51 for the first time.

1. Install a micro secure digital (SD) card (optional).
2. Install hand strap (optional).
3. Install the battery.
4. Charge the TC51.
5. Power on the TC51.

Installing a microSD Card

The microSD card slot provides secondary non-volatile storage. The slot is located under the battery pack. Refer to the documentation provided with the card for more information, and follow the manufacturer's recommendations for use.



CAUTION Follow proper electrostatic discharge (ESD) precautions to avoid damaging the microSD card. Proper ESD precautions include, but are not limited to, working on an ESD mat and ensuring that the operator is properly grounded.

1. Lift the access door.

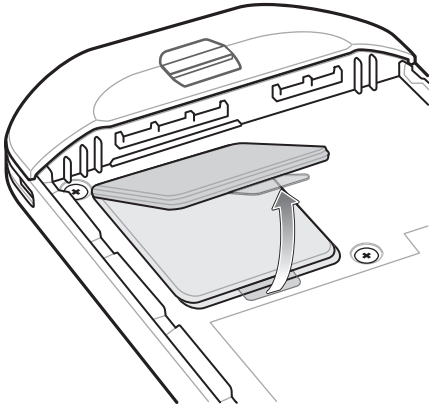

Figure 1-3 *Lift Access Door*

2. Slide the microSD card holder to the unlock position.

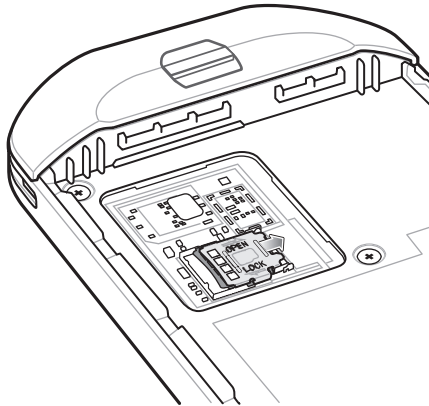

Figure 1-4 *Unlock microSD Card Holder*

3. Lift the microSD card holder.

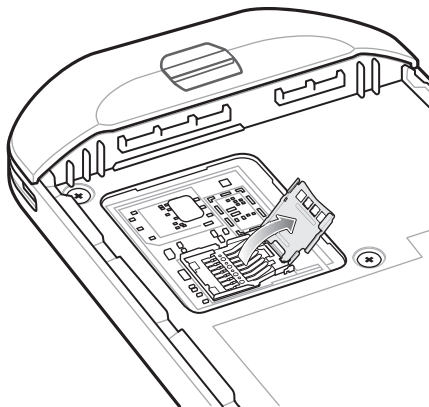

Figure 1-5 *Lift the microSD Card Holder*

4. Insert the microSD card into the card holder door ensuring that the card slides into the holding tabs on each side of the door.

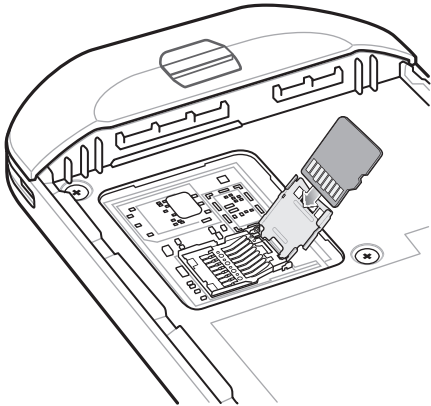

Figure 1-6 *Insert microSD Card in Holder*

5. Close the microSD card holder and slide into the lock position.

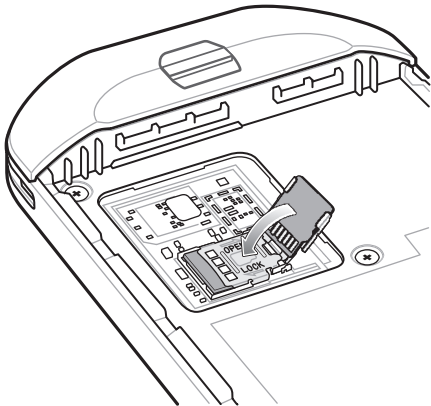

Figure 1-7 *Re-install Access Door*



CAUTION Access door must be replaced and securely seated to ensure proper device sealing.

6. Re-install the access door.

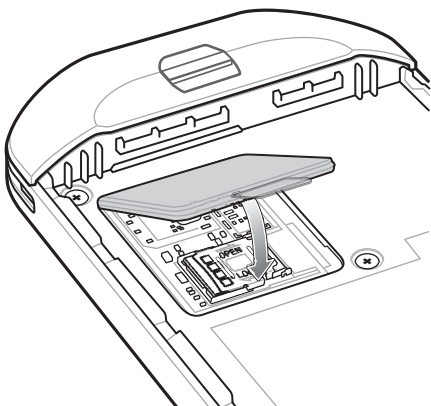

Figure 1-8 *Replace Access Door*

Installing the Battery

1. Insert the battery, bottom first, into the battery compartment in the back of the TC51.

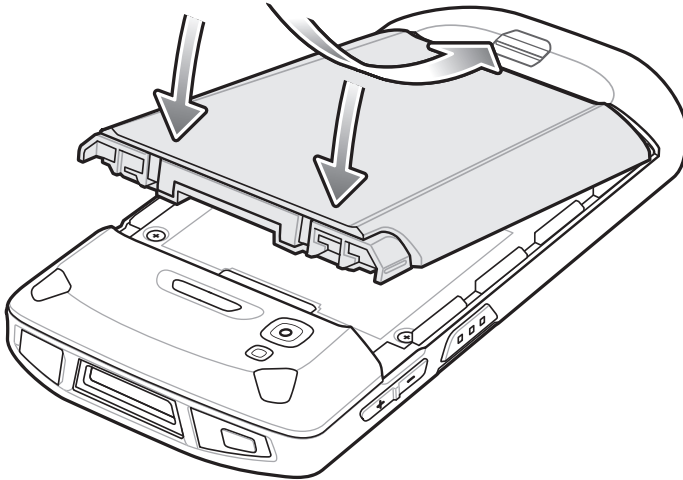

Figure 1-9 *Insert Bottom of Battery into Battery Compartment*

2. Press the battery down into the battery compartment until the battery release latches snap into place.

Charging the Battery

Before using the TC51 for the first time, charge the main battery until the green Charging/Notification light emitting diode (LED) remains lit. To charge the TC51 use a cable or a cradle with the appropriate power supply. For information about the accessories available for the TC51 see [Chapter 6, Accessories](#) for more information.

The 4,300 mAh (typical) / 4,050 mAh (minimum) battery charges from fully depleted to 90% in approximately 2.5 hours and from fully depleted to 100% in approximately three hours.



NOTE In many cases the 90% charge provides plenty of charge for daily use. A full 100% charge lasts for approximately 14 hours of use.







To achieve the best fast charging results use only Zebra charging accessories and batteries. Charge batteries at room temperature with the TC51 in sleep mode.

Charge batteries in temperatures from 0°C to 40°C (32°F to 104°F). The TC51 or accessory always performs battery charging in a safe and intelligent manner. At higher temperatures (e.g. approximately +37°C (+98°F)) the TC51 or accessory may for small periods of time alternately enable and disable battery charging to keep the battery at acceptable temperatures. The TC51 or accessory indicates when charging is disabled due to abnormal temperatures via its LED and a notification appears on the display.

1. To charge the main battery, connect the charging accessory to the appropriate power source.
2. Insert the TC51 into a cradle or attach to a cable. The TC51 turns on and begins charging. The Charging/Notification LED blinks amber while charging, then turns solid green when fully charged.

Charging Indicators

Table 1-3 Charging/Notification LED Charging Indicators

State	LED	Indication
Off		TC51 is not charging. TC51 is not inserted correctly in the cradle or connected to a power source. Charger/cradle is not powered.
Slow Blinking Amber (1 blink every 4 seconds)		TC51 is charging.
Slow Blinking Red (1 blink every 4 seconds)		TC51 is charging but the battery is at end of useful life.
Solid Green		Charging complete.
Solid Red		Charging complete but the battery is at end of useful life.
Fast Blinking Amber (2 blinks/second)		Charging error, e.g.: <ul style="list-style-type: none"> • Temperature is too low or too high. • Charging has gone on too long without completion (typically eight hours).
Fast Blinking Red (2 blinks/second)		Charging error but the battery is at end of useful life., e.g.: <ul style="list-style-type: none"> • Temperature is too low or too high. • Charging has gone on too long without completion (typically eight hours).

Google Account Setup



NOTE The TC51 has to be connected to the internet in-order to set up a Google account.

Google account only required on devices with GMS software.

The first time the TC51 starts, the Setup Wizard displays. Follow the on-screen instructions to set up a Google account, configure Google Wallet for purchasing items from the Play Store, entering your personal information, and enabling backup/restore features.

Replacing the Battery



CAUTION Do not add or remove microSD card during battery replacement.

1. Press the Power button until the menu appears.
2. Touch **Battery Swap**.
3. Follow the on-screen instructions.

4. Wait for the LED to turn off.
5. If hand strap is attached, remove hand strap.
6. Press the two battery latches in.

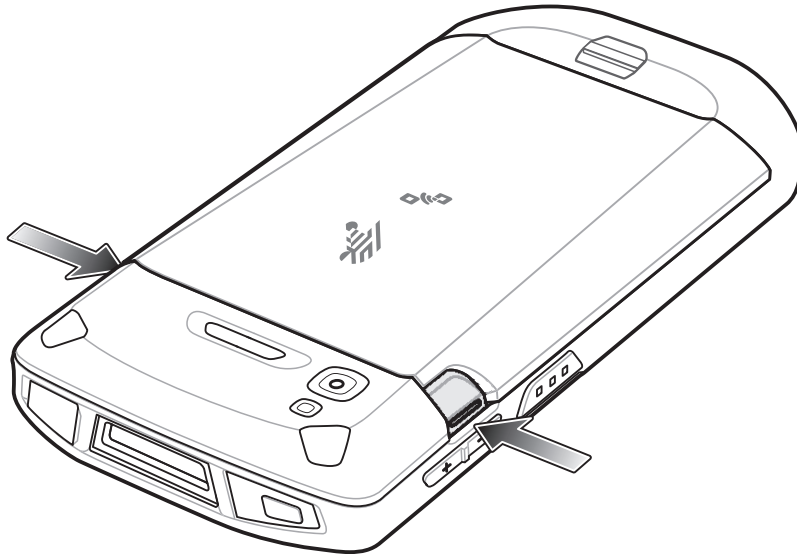

Figure 1-10 Press Battery Latches

7. Lift the battery from the TC51 or TC51-HC.

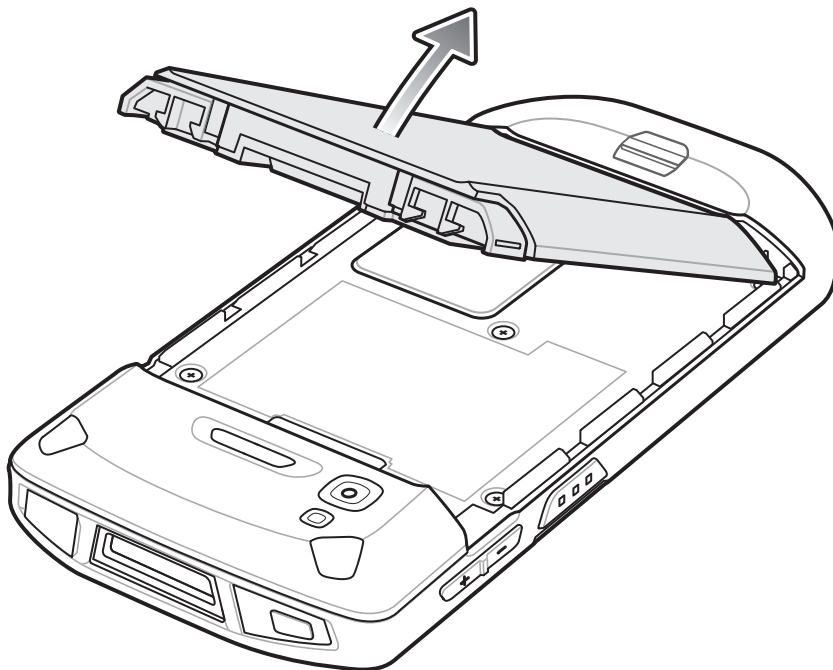

Figure 1-11 Lift the Battery



CAUTION Replace the battery within 90 seconds. After 90 seconds the device reboots and data may be lost.

8. Insert the replacement battery, bottom first, into the battery compartment in the back of the TC51 or TC51-HC.

9. Press the battery down until the battery release latches snap into place.
10. Replace the hand strap, if required.
11. Press the Power button to turn on the TC51 or TC51-HC.

Replacing the microSD Card

To replace the microSD card:

1. Press the Power button until the menu appears.
2. Touch **Power off**.
3. Touch **OK**.
4. If hand strap is attached, slide the hand strap clip up toward the top of the TC51 and then lift.
5. Press the two battery latches in.
6. Lift the battery from the TC51.
7. Lift the access door.

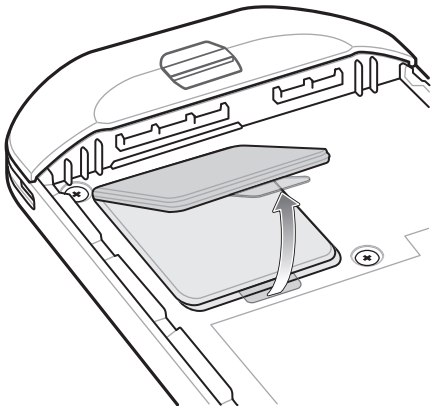

Figure 1-12 *Remove Access Door*

8. Remove microSD card from holder.
9. Insert the replacement microSD card.



CAUTION Access door must be replaced and securely seated to ensure proper device sealing.

10. Replace the access door.

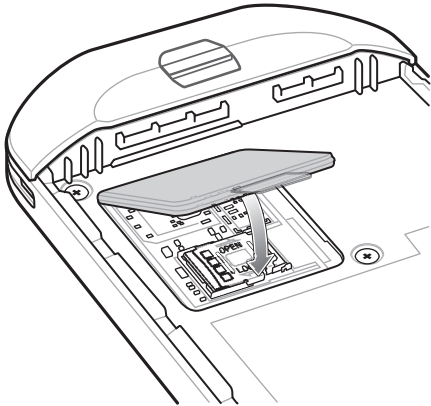





Figure 1-13 Replace Access Door

11. Insert the battery, bottom first, into the battery compartment in the back of the TC51.
12. Press the battery down until the battery release latches snap into place.
13. Replace the hand strap, if required.
14. Press and hold the Power button to turn on the TC51.

Accessing Device Settings

Throughout this guide, the user can access device:

1. Swipe down with two fingers from the status bar to open the quick access panel and then touch .
2. On the Home screen, touch  > .

Battery Management





NOTE Prior to checking the battery charge level, remove the TC51 from any AC power source (cradle or cable).

To check the charge status of the main battery, open Settings and touch  **About phone** > **Battery Information**.

Battery status indicates that the battery is discharging and **Battery level** lists the battery charge (as a percentage of fully charged). The battery percentage can also be viewed next to the battery icon in the quick access panel. Swipe down with two fingers from the status bar to open the quick access panel.

Monitor Battery Usage

The **Battery** screen lists which applications consume the most battery power. Also use it to turn off applications that were downloaded if they are consuming too much power.

1. Swipe down with two fingers from the status bar to open the quick access panel and then touch .
2. Touch  **Battery**.

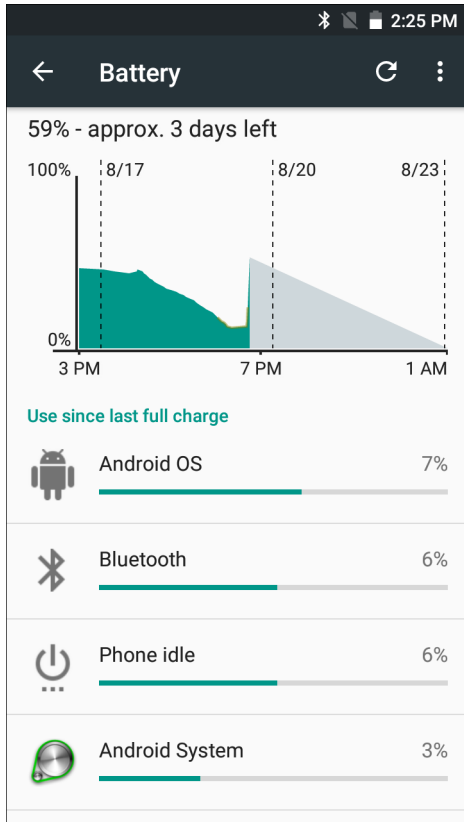

Figure 1-14 Battery Screen

The Battery screen lists the applications using the battery. The discharge graph at the top of the screen shows the rate of the battery discharge since last charged (short periods of time when connected to a charger are shown as thin green lines at the bottom of the chart), and how long it has been running on battery power.

Touch an application in the Battery screen to display details about its power consumption. Different applications display different information. Some applications include buttons that open screens with settings to adjust power use.

Low Battery Notification

When the battery charge level drops below 18%, the TC51 displays a notice to connect the TC51 to power. The user should charge the battery using one of the charging accessories.

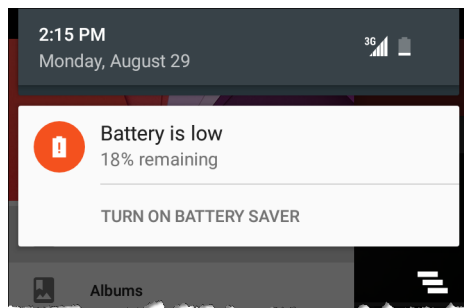

Figure 1-15 Low Battery Notification

When the battery charge drops below 10%, the TC51 displays a notice to connect the TC51 to power. The user must charge the battery using one of the charging accessories.

When the battery charge drops below 4%, the TC51 turns off.

The user must charge the TC51 using one of the charging accessories.

Battery Optimization

Observe the following battery saving tips:

- Disable DataWedge Launcher profile. Refer to the *TC51 Touch Computer Integrator Guide for Android 6.0.1* for instructions.
- Set the screen to turn off after a short period of non-use. See *Setting Screen Timeout Setting on page 1-15*.
- Reduce screen brightness. See *Setting the Screen Brightness on page 1-14*.
- Turn off all wireless radios when not in use.
- Turn off automatic syncing for Email, Calendar, Contacts and other applications.
- Minimize use of applications that keep the TC51 from suspending, for example, music and video applications.



Turning Off the Radios

To turn off all the radios:

1. Press the Power button until the menu appears.
2. Touch **Airplane mode**. The airplane icon  appears in the Status bar indicating that all the radios are off.

Setting the Date and Time

The date and time is automatically synchronized using a NITZ server when the TC51 is connected to a cellular network. The user is only required to set the time zone or set the date and time when not connected to a cellular network or if the wireless LAN does not support Network Time Protocol (NTP).

1. Swipe down with two fingers from the status bar to open the quick access panel and then touch .
2. Touch  **Date & time**.
3. Touch **Automatic date & time** to disable automatic date and time synchronization.
4. Touch **Set date**.
5. Move the sliders up and down to select the month, date and year.
6. Touch **Done**.
7. Touch **Set time**.
8. Move the sliders up and down to select the hour, minutes and part of the day.
9. Touch **Done**.
10. Touch **Select time zone**.
11. Select the current time zone from the list.
12. Touch .

Display Setting

Use Display settings to change the screen brightness, change the background image, enable screen rotation, set sleep time and change font size.

Setting the Screen Brightness

To manually set the screen brightness:



1. Swipe down with two fingers from the status bar to open the quick access panel and then touch .
2. Touch  **Display**.
3. Touch **Brightness Level**.





Figure 1-16 *Brightness Dialog Box*

To let the TC51 automatically adjust the screen brightness using the built-in light sensor:

1. If disabled, touch **Adaptive brightness** to automatically adjust the brightness.
By default, **Adaptive brightness** is enabled. Toggle the switch to disable.
2. Touch .

Setting Screen Rotation

By default, screen rotation is disabled. To enable screen rotation:

1. Swipe down with two fingers from the status bar to open the quick access panel and then touch .
2. Touch  **Display**.
3. Touch **When device is rotated** and select **Rotate the contents of the screen** to set the TC51 to automatically switch orientation when the TC51 is rotated.
4. Touch .

Setting Home Screen Rotation

By default the Home screen rotation is disabled. To enable Home screen rotation:

1. Touch and hold anywhere on the Home screen until the options appear.
2. Touch .
3. Touch **Allow rotation**.
4. Touch .
5. Rotate the device.

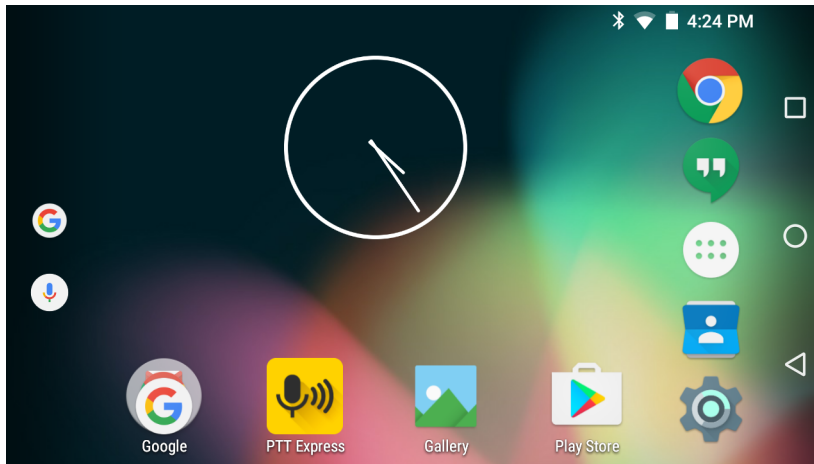





Figure 1-17 Rotated Home Screen



Setting Screen Timeout Setting

To set the screen sleep time:

1. Swipe down with two fingers from the status bar to open the quick access panel and then touch .
2. Touch  **Display**.
3. Touch **Sleep**.
4. Select one of the sleep values.
 - 15 seconds
 - 30 seconds
 - **1 minute** (default)
 - 2 minutes
 - 5 minutes
 - 10 minutes
 - 30 minutes
5. Touch .

Setting Font Size

To set the size of the font in system applications:

1. Swipe down with two fingers from the status bar to open the quick access panel and then touch .
2. Touch  **Display**.
3. Touch **Font size**.
4. Select one of the font size values.
 - Small
 - **Normal** (default)



- Large
 - Huge
5. Touch .

Touch Panel Mode

The TC51 display is able to detect touches using a finger, a conductive-tip stylus or gloved finger with or without a screen protector.



NOTE A glove can be made of medical latex, leather, cotton or wool.
For optimal performance use Zebra certified stylus.

1. Swipe down with two fingers from the status bar to open the quick access panel and then touch .
2. Touch  **Display**.
3. Touch **Touch panel mode**.

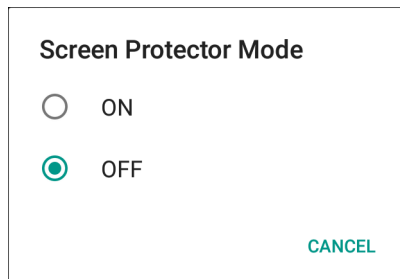
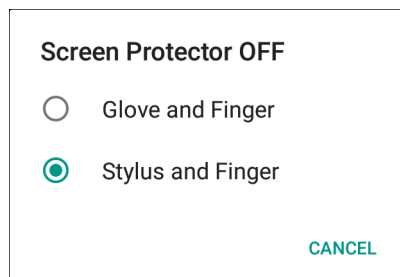
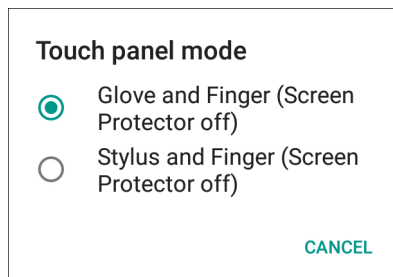

Figure 1-18 Touch Panel Mode - Screen Protector (TC51-Standard)

4. For TC51-Standard, Touch **ON** if the device has a screen protector or **OFF** if it does not.



TC51-Standard





TC51-HC

Figure 1-19 Touch Panel Mode - Touch Selection

5. Touch **Glove and Finger** to use a finger or a gloved finger on the screen or touch **Stylus and Finger** to use a finger or a stylus on the screen.
6. Touch .



Setting Notification LED

The Charging/Notification LED lights blue when an application, such as email and VoIP, generates a programmable notification or to indicate when the TC51 is connected to a Bluetooth device. By default, LED notifications are enabled. To change the notification setting:

1. Swipe down with two fingers from the status bar to open the quick access panel and then touch .
2. Touch  **Sounds & notifications**.
3. Touch **Pulse notification light** to toggle the notification on or off.
4. Touch .

General Sound Setting

Use the **Sound & notification** settings to configure media, alarm, and ring volumes, and to set notifications.

1. From the Home screen, touch  >  **Sound & notification**.

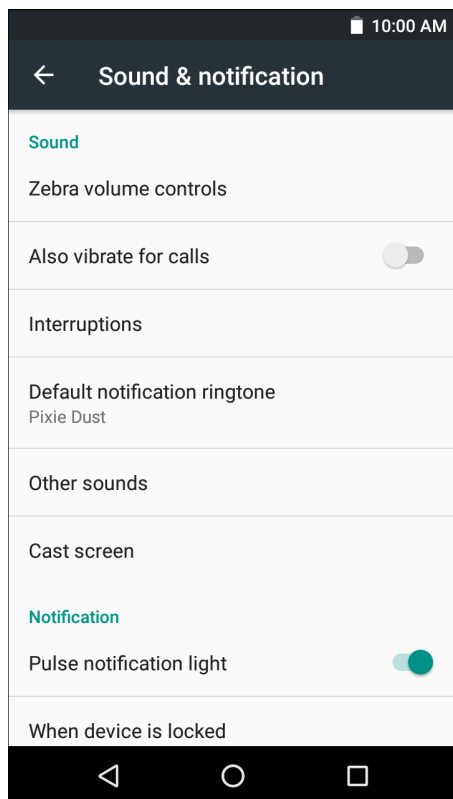

Figure 1-20 *Default Sound & Notification Screen*

- **Sound**

- **Zebra volume controls** - Touch to configure the media, ringtone, notifications, alarm, and scanner volume. Available on builds BSP 19-01.4 and above.
- **Also vibrate for calls** - Touch to enable the MC40 to also vibrate on incoming calls (VoIP telephony ready only).
- **Interruptions** - Use to prioritize sound notifications. Touch the settings to turn call and message interruptions on or off.

If user turns Messages notifications on, touch **Calls/messages from** to specify from whom to accept notifications (**Anyone**, **Starred contacts only** or **Contacts Only**).

In **Downtime** section, select which days and times to allow for sound notifications.

- **Default notification ringtone** - Touch to select a sound to play for all system notifications.
- **Other sounds**
 - **Screen locking sounds** - Plays a sound when locking and unlocking the screen (default – enabled)
 - **Charging sounds** - Plays a sound when the device comes in contact with a wireless charger (default – enabled)
 - **Touch sounds** - Plays a sound when making screen selections (default – enabled).
 - **Vibrate on touch** - Vibrates when making screen selections (default – enabled).
- **Cast screen** - Share phone content on Chromecast or a television with Google Cast built-in. Touch cast screen to display a list of devices, then touch a device to begin casting.

- **Notification**

- **Pulse notification light** - The LED indicator notifies of a missed notification, low battery or battery is charging when the device screen is turned off. A blinking blue light may mean an App notification is waiting, while a blinking red light may mean the battery is low.
- **When device is locked** - Manage whether notifications can be seen when the TC51 is locked.
 - **Show all notification content** - Notifications and their details display on the lock screen.
 - **Hide sensitive notification content** - Notifications display on the lock screen, but any details that could reveal private information is automatically hidden.
 - **Don't show notifications at all** - Notifications do not display on the lock screen. Notifications display once the device is unlocked.
- **App notifications** - Modify the notification settings individually for an application. The setting under **When device is locked** always takes precedence over the setting for an individual application.

- **Advanced**

- **Notification access** - Displays which applications can access notifications.

When a notification arrives, its icon appears at the top of the screen. Icons for pending notifications appear on the left, and system icons on the right.

Do Not Disturb access - Provides a way to mute notifications for apps which are installed on the device and have requested Do Not Disturb access.

2. Select **Zebra volume controls** to configure the media, ringtone, notifications, alarm, and scanner volume.
3. On the **Zebra Volume Control** screen, slide each setting as desired.

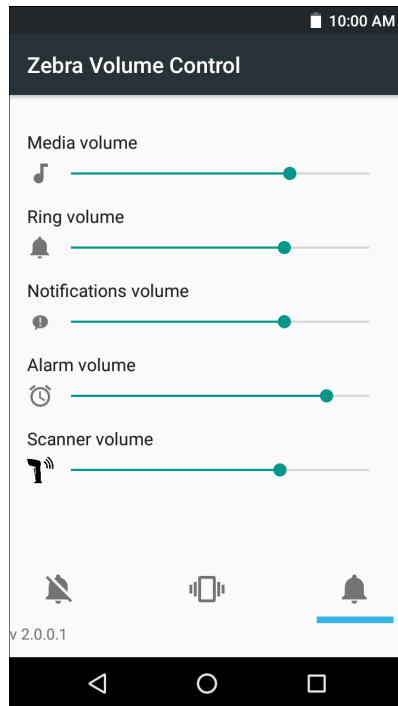

Figure 1-21 Zebra volume Control Screen

- Volume Controls
 - Media volume - Controls the music, games and media volume.
 - Ring volume - Controls the ringtone volume.
 - Notifications volume- Controls the system notification volume.
 - Alarm volume - Controls the alarm clock volume.
 - Scanner volume - Controls the scan good decode beep volume.
- Bottom row icons:
 - - Places all sounds except media and alarms in silence mode.
 - - Places all sounds except media and alarms in vibrate mode.
 - - Places all sounds in sound mode.

Wake-Up Sources

By default the TC51 wakes from suspend mode when the user presses the power button. The TC51 can be configured to wake when the user presses the PPT or Scan buttons on the left side of the device.

1. Swipe down with two fingers from the status bar to open the quick access panel and then touch .
2. Touch **Wake-Up Sources**.

3. Touch **Keypad** checkbox. A check appears in the checkbox.

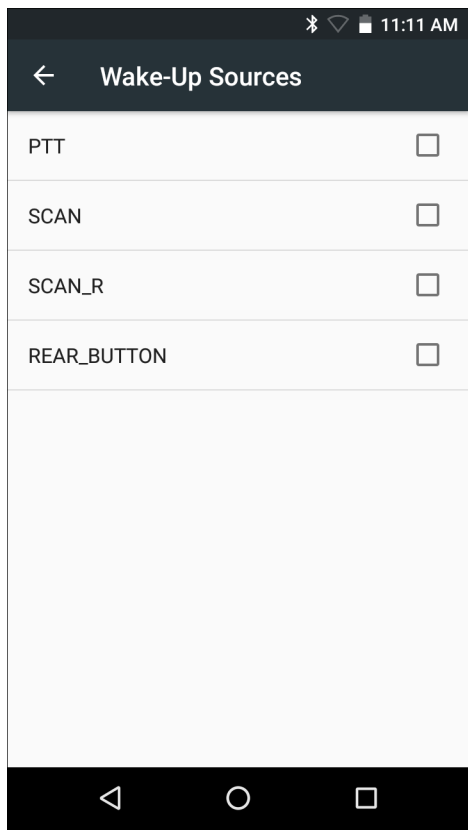

Figure 1-22 *Wake-Up Sources*

4. Touch .

CHAPTER 2 USING THE TC51

Introduction

This chapter explains the buttons, status icons, and controls on the TC51, and provides basic instructions for using the TC51 including resetting the TC51 and entering data.

Google Mobile Services



NOTE This section only applies to TC51 configurations with Google Mobile Services (GMS).

The TC51 with GMS contains applications and services that provide additional functionality to the TC51.

GMS includes:

- **Applications** - GMS adds a variety of Google applications and associated widgets including Chrome, Gmail, Drive and Maps.
- **Services:**
 - **Speech to Text** - Allows for free format speech to text, in many languages for both connected and disconnected network. Launch by touching the microphone icon on the keyboard.
 - **TalkBack Service** - Provides spoken feedback on various parts of the user interface. To enable, go to **Settings > Accessibility**.
 - **Network Location Provider** - Adds a location provider which uses mobile network tower information and Wi-Fi access point information to provide a location without using GPS. To enable, go to **Settings > Location access**.
 - **Widevine DRM** - Enables the digital rights management so that protected content can be played. Enable via DRM Info from the Play Store.
 - **Google Cloud Messaging** - Allows the sending of data from your server to your TC51 and also to receive messages from devices on the same connection.
 - **Backup and Restore** - Allows the users settings and applications to be backed up to a Google server and subsequently restored from that server after a factory reset.

- **Google accounts** - Create and use a Google account to synchronize mail, files, music, photos, contacts and calendar events.

Home Screen

The Home screen displays when the TC51 turns on. Depending upon the configuration, the Home screen might appear different. Contact your system administrator for more information.

After a suspend or screen time-out, the Home screen displays with the lock sliders. Touch the screen and slide up to unlock. For screen locking information see *Un-Locking the Screen on page 2-18*.



Figure 2-1 Home Screen

Table 2-1 Home Screen Items

Item	Description
1 — Recent Button	Displays recently used applications.
2 — All Apps Icon	Opens the APPS window.
3 — Home	Displays the Home screen.
4 — Back	Displays the previous screen.

Table 2-1 Home Screen Items (Continued)

Item	Description
5 — Shortcut Icons	Opens applications installed on the TC51. See <i>Application Shortcuts and Widgets on page 2-6</i> for more information.
6 — Widgets	Launches stand-alone applications that run on the Home screen. See <i>Application Shortcuts and Widgets on page 2-6</i> for more information.
7 — Status Bar	Displays the time, status icons (right side), and notification icons (left side). For more information see <i>Status Bar on page 2-3</i> and <i>Managing Notifications on page 2-5</i> .

The Home screen provides four additional screens for placement of widgets and shortcuts. When available, swipe the screen left or right to view the additional screens. The additional screens are not viewable by default.

Some apps (e.g., Camera and Gallery) use the whole screen and hide the three soft button on the bottom of the screen.

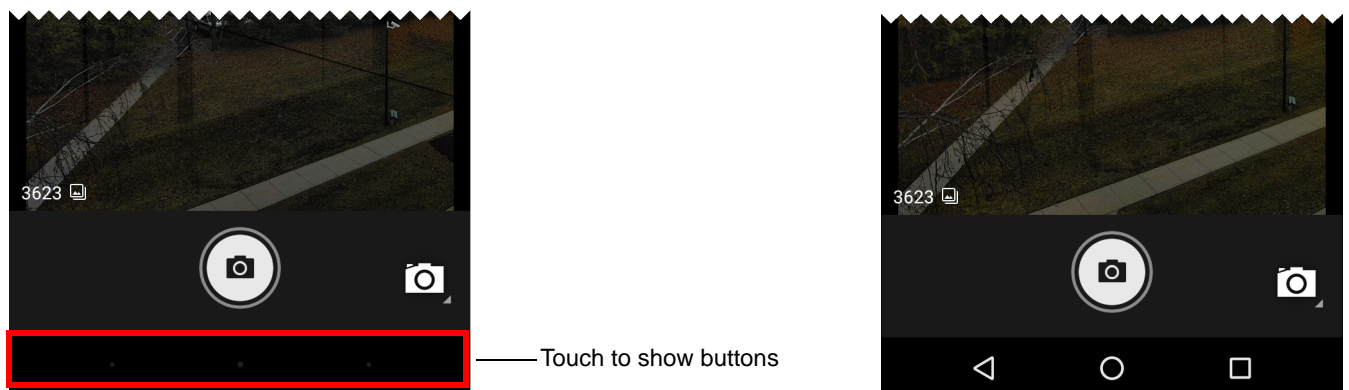
**Figure 2-2** Hidden Soft Buttons

To show the button, touch the soft button area to display the button icons.

Status Bar

The Status bar displays the time, status icons (right side), and notification icons (left side).













✓ **NOTE** Some Status icons might not appear in the Status Bar if there are too many icons to display.

**Figure 2-3** Notification and Status Icons

If there are more notifications than can fit in the Status bar,  displays indicating that more notifications exist. Open the Notifications panel to view all notifications and status.

Status Icons

Table 2-2 *Status Icons*

Icon	Description
	Indicates that the Alarm is active.
	Indicates that the main battery is fully charged.
	Indicates that the main battery is partially drained.
	Indicates that the main battery charge is low.
	Indicates that the main battery charge is very low.
	Indicates that the main battery is charging.
	Indicates that all sounds except media and alarms are silenced and vibrate mode is active.
	Indicates that the Airplane Mode is active. All radios are turned off.
	Indicates that Bluetooth is on.
	Connected to a Wi-Fi network.
	Not connected to a Wi-Fi network or no Wi-Fi signal.
	Connected to an Ethernet network.

Notification Icons

Table 2-3 *Notification Icons*

















Icon	Description
	Indicates the main battery is low.
	Indicates that more notifications are available for viewing.
	Indicates that data is syncing.
	Indicates an upcoming event.
	Indicates that an open Wi-Fi network is available.
	Indicates that a song is playing (Non-GMS/GMS).

Table 2-3 *Notification Icons (Continued)*

Icon	Description
	Indicates that a problem with sign-in or sync has occurred.
	Indicates that the TC51 is uploading data.
	Indicates that the TC51 is downloading data when animated and download is complete when static.
	Indicates that the TC51 is connected via USB cable.
	Indicates that the TC51 is connected to or disconnected from virtual private network (VPN).
	Preparing Internal Storage.
	Indicates that USB debugging is enabled on the TC51.
	Headset is connected to device.
	Indicates the status of the PTT Express Voice Client. See Notification Icons for complete list of PTT Express notification icons.
	Indicates that RxLogger application is running.
	Indicates the RS507 or the RS6000 is connected to the TC51. (Available on builds BSP 16-04 and above.)

Managing Notifications

Notification icons report the arrival of new messages, calendar events, and alarms, as well as ongoing events. When a notification occurs, an icon appears in the Status bar with a brief description. See *Notification Icons on page 2-4* for a list of possible notification icons and their description. Open the Notifications panel to view a list of all the notifications.

To open the Notification panel drag the Status bar down from the top of the screen.

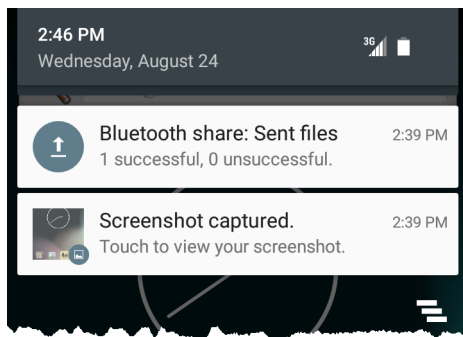
**Figure 2-4** *Notification Panel*

To respond to a notification, open the Notifications Panel and then touch a notification. The Notifications Panel closes and the subsequent activity is dependent on the notification.

To clear all notifications, open the Notifications Panel and then touch . All event-based notifications are removed. Ongoing notifications remain in the list.

Ongoing notifications remain in the list.

To close the Notification Panel, swipe the Notifications Panel up.

Use Quick Access Panel to get to frequently used settings, like turning on airplane mode. To open Quick Access Panel, swipe down from the top of the screen with two fingers or twice with one finger.

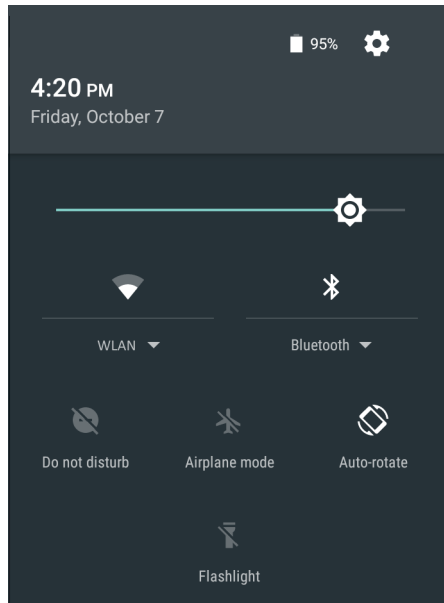

Figure 2-5 Quick Settings

To change a setting, just touch the icon:

- Display brightness: Slide to lower or increase the brightness of the screen.
- Wi-Fi network: Turn Wi-Fi on or off. To open Wi-Fi settings, touch the Wi-Fi network name.
- Bluetooth settings: Turn Bluetooth on or off. To open Bluetooth settings, touch the **Bluetooth**.
- Do not disturb: Control how and when to receive notifications.
- Airplane mode: Turn airplane mode on or off. Airplane mode means device will not connect to Wi-Fi or Bluetooth.
- Auto-rotate: Lock the device's orientation in portrait or landscape mode or set to automatically rotate.
- Flashlight: Turn camera flash on or off.
- Location: Enable or disable locationing feature.

Application Shortcuts and Widgets

Application shortcuts placed on the Home screen allow quick and easy access to applications. Application Widgets are self-contained applications placed on the Home screen to access frequently used features.

Adding an Application to the Home Screen

1. Go to the desired Home screen.
2. Touch .

3. Scroll through the list to find the application icon.
4. Touch and hold the icon until the Home screen appears.
5. Position the icon on the screen and then release.

Adding a Widget to the Home Screen

To add a widget to the Home screen:

1. Go to the desired Home screen.
2. Touch and hold until the menu appears.
3. Touch **WIDGETS**.
4. Scroll through the list to find the widget.
5. Touch and hold the widget until the Home screen appears.
6. Position the widget on the screen and then release.

Moving Items on the Home Screen

1. Touch and hold the item until it floats on the screen.
2. Drag the item to a new location. Pause at the edge of the screen to drag the item onto an adjacent Home screen.
3. Lift finger to place the item on the Home screen.

Removing an Application Shortcut or Widget from the Home Screen

1. Go to the desired Home screen.
2. Touch and hold the application shortcut or widget icon until it floats on the screen.
3. Drag the icon to  **Remove** on the top of the screen and then release.

Folders

Use **Folders** to organize similar applications together. Tap the folder to open and display items in the folder.

Creating a Folder

To create a folder, there must be at least two app icons on the Home screen.

1. Go to the desired Home screen.
2. Touch and hold on one application icon.
3. Drag the icon and stack on top of another icon.
4. Lift and release.

Naming Folders

To name a folder:

1. Touch the folder.

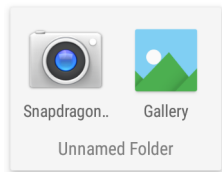

Figure 2-6 *Open Folder*

2. Touch the title area and enter a folder name using the keyboard.
3. Touch **Done** on the keyboard.
4. Touch anywhere on the Home screen to close the folder. The folder name appears under the folder.



Figure 2-7 *Renamed Folder*

Removing a Folder

To remove a folder:

1. Touch and hold the folder icon.
2. Drag the folder to  **Remove** and release.

Home Screen Wallpaper

To change the Home screen wallpaper:

1. Touch and hold on the screen until the menu appears.
2. Touch **WALLPAPERS**.
3. Touch **My photos** to select a photo from Gallery or select one of the pre-installed photos.
4. Touch **Set wallpaper**.

Using the Touchscreen

Use the multi-tap sensitive screen to operate the device.

- **Tap** - Tap to:
 - select items on the screen
 - type letters and symbols using the on-screen keyboard
 - press on-screen buttons.
- **Tap and Hold** - Tap and hold:
 - an item on the Home screen to move it to a new location or to the trash.
 - an item in Apps to create a shortcut on the Home screen.
 - the Home screen to open a menu for customizing the Home screen.
 - an empty area on the Home screen until the menu appears.

- **Drag** - Tap and hold an item for a moment and then move finger on the screen until reaching the new position.
- **Swipe**- Move finger up and down or left and right on the screen to:
 - unlock the screen
 - view additional Home screens
 - view additional application icons in the Launcher window
 - view more information on an application's screen.
- **Double-tap** - Tap twice on a web page, map, or other screen to zoom in and out.
- **Pinch** - In some applications, zoom in and out by placing two fingers on the screen and pinching them together (to zoom out) or spreading them apart (to zoom in).

Keyboards



The TC51 provides two types of keyboards:

- Android Keyboard (default)
- Enterprise Keyboard.



NOTE By default the Enterprise keyboard is disabled. To enable the Enterprise keyboard, refer to the *TC51 Touch Computer Integrator Guide for Android Version 6.0.1*.

To switch between keyboards:

1. Touch in a text box to display the current keyboard.
2. On the Enterprise keyboard, touch  or on the Android keyboard, touch .

Keyboard Configuration

To configure the keyboard, See the Keyboard Settings section in the *TC51 Touch Computer Integrator Guide for Android Version 6.0.1*.

Using the Enterprise Keyboard

The Enterprise Keyboard contains the following keyboards:

- Numeric
- Alpha
- Special characters
- Data capture.

Numeric Tab

To access the numeric keyboard, touch the **123** tab. The keys displayed vary on the application being used. For example, an arrow displays in **Contacts**, however **Done** displays in **Email** account setup.

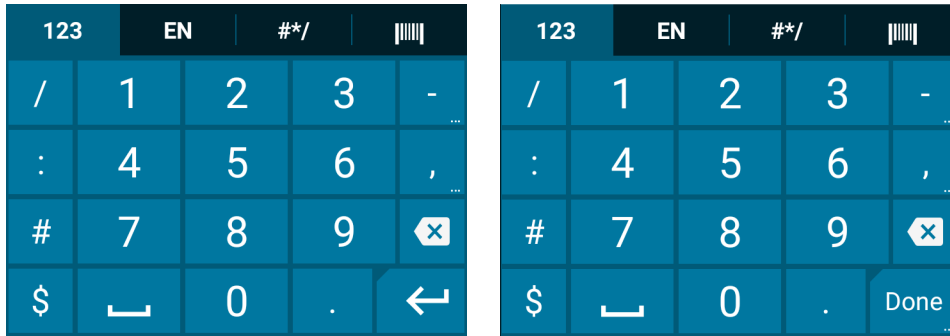

Figure 2-8 *Numeric Keyboard*

Alpha Tab

To access the alpha keyboard, touch the **EN** tab.



NOTE The Enterprise keyboard support English (US), English (UK), French, German, Spanish and Italian. When a keyboard language is selected in Settings, the corresponding keyboard language displays.



Figure 2-9 *Alpha Keyboard*

Touch 😊 to enter emoji icons in a text message.

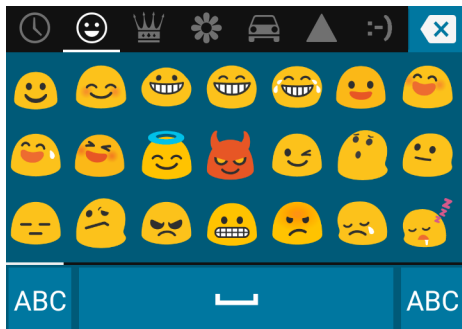

Figure 2-10 *Emoji Keyboard*

Touch **ABC** to return to the Alpha keyboard.

Additional Character Tab

To access additional characters, touch the **#*/** tab.



Figure 2-11 Symbols Keyboard



Scan Tab

The Scan tab provides an easy data capture feature for scanning bar codes.



Figure 2-12 Scan Keyboard

Using the Android Keyboard

Use the on-screen keyboard to enter text in a text field. To configure the keyboard settings, touch and hold  (comma) >  and then select **Android keyboard settings**.

Editing Text

Edit entered text and use menu commands to cut, copy, and paste text within or across applications. Some applications do not support editing some or all of the text they display; others may offer their own way to select text.

Entering Numbers, Symbols and Special Characters

To enter numbers and symbols:

- Touch and hold one of the top-row keys until a menu appears then select a number. Keys with alternate characters display an ellipsis (...) below the character.
- Touch the Shift key once for a single capital letter. Touch the Shift key twice to lock in uppercase. Touch the Shift key a third time to unlock Capslock.
- Touch  to switch to the numbers, symbols keyboard and additional symbols.

To enter special characters, touch and hold a number or symbol key to open a menu of additional symbols.

- A larger version of the key displays briefly over the keyboard.

- Keys with alternate characters display an ellipsis (...) below the character.

Applications

The **APPS** screen displays icons for all installed applications. The table below lists the applications installed on the TC51. Refer to the *TC51 Touch Computer Integrator Guide for Android Version 6.0.1* for information on installing and uninstalling application.

Table 2-4 Applications











Icon	Description
	ActiveEdge Touch Zone - Provides quick and convenient ont-touch access to key features or applications while users are in the middle of other workflow applications or tasks. Available on builds BSP 19-01.4 and above.
	AppGallery - Provides links to utilities and demonstration applications that can be installed on the TC51.
	Settings - Use to configure the TC51.
	Battery Swap – Use to place device in Battery Swap mode when replacing the battery.
	Bluetooth Pairing Utility – Use to pair the RS507 Hans-free Imager with the TC51 by scanning a bar code.
	Browser - Use to access the Internet or intranet.
	Calculator - Provides the basic and scientific arithmetic functions.
	Calendar - Use to manage events and appointments. TC51 with GMS only.
	Camera - Take photos or record videos. For more information see <i>Camera on page 3-10</i> .
	Chrome - Use to access the Internet or intranet. TC51 with GMS only.
	Clock - Use to schedule alarms for appointments or as a wake-up.

Table 2-4 Applications (Continued)



Icon	Description
	Contacts - Use to manage contact information. See <i>Contacts on page 3-9</i> for more information.
	DataWedge - Enables data capture using the imager.
	Downloads - lists all downloads files.
	Drive - Upload photos, videos, documents, and other files to personal storage site. TC51 with GMS only.
	DWDemo - Provides a way to demonstrate the data capture features using the imager. See <i>DataWedge Demonstration on page 3-22</i> for more information.
	elemez — Use to provide diagnostic information. See <i>Elemesz on page 3-40</i> for more information.
	Email - Use to send and receive email.
	File Browser - Organize and manage files on the TC51. See <i>File Browser on page 3-8</i> for more information.
	Gallery - Use to view photos stored on the microSD card. For more information, see <i>Gallery on page 3-15</i> for more information.
	Gmail - Use to send and receive email using a Google email account. TC51 with GMS only.
	Google - Launches Google search application. TC51 with GMS only.
	Google+ - Connect with people on Google social network. TC51 with GMS only.
	Hangouts - Use to communicate with friends using text messages and photos. TC51 with GMS only.

Table 2-4 Applications (Continued)









Icon	Description
	Maps - Use to see your location on a map (with public transit, traffic or satellite overlays). Search for any business or place of interest. Provides turn-by-turn navigation with voice guidance and traffic-avoidance and alternate routes, for drivers, cyclist, walkers and users of public transportation. TC51 with GMS only.
	MobiControl Stage – Opens the MobiControl Stage application to stage the device.
	Music - Play music stored on the microSD card. TC51 without GMS only.
	News & Weather - Provides news and weather information.
	Notes - Use to take and save notes.
	Phone - Use to dial a phone number when used with some Voice over IP (VoIP) clients (VoIP telephony ready only). Available on builds BSP 19-01.4 and above.
	Photos - Use to sync photos with Google account. TC51 with GMS only.
	Play Books - Use to read books. TC51 with GMS only.
	Play Games - Use to play games. TC51 with GMS only.
	Play Movies & TV - View movies and video on your device. TC51 with GMS only.
	Play Music - Use to listen to music. TC51 with GMS only.
	Play Newsstand - Displays current news. TC51 with GMS only.

Table 2-4 Applications (Continued)















Icon	Description
	Play Store - Download music, movies, books, and Android apps and games from the Google Play Store. TC51 with GMS only.
	PTT Express - Use to launch PTT Express client for VoIP communication.
	Rapid Deployment - Allows the TC51 to stage a device for initial use by initiating the deployment of settings, firmware and software. Requires the purchase of an MSP client license per device.
	RxLogger - Use to diagnose device and application issues. See the <i>TC51 Touch Computer Integrator Guide for Android Version 6.0.1</i> for more information.
	Battery Manager - Displays battery information, including charge level, status, health and wear level.
	SimulScan Demo - Use to demonstrate the document capture feature of the TC51. Available on builds BSP 19-01.4 and above.
	SMARTMU - A diagnostic intelligent app. Use to diagnose surrounding area and display network stats, such as coverage hole detection, or AP in vicinity. Available on builds BSP 19-01.4 and above.
	Sound Recorder - Use to record audio. TC51 without GMS only.
	StageNow - Allows the TC51 to stage a device for initial use by initiating the deployment of settings, firmware and software.
	Tethering & portable hotspot - Use to configure tethering and Wi-Fi hotspot.
	Videos - Play videos on the device. TC51 without GMS only.
	Voice Search - Use to perform searches by asking questions. TC51 with GMS only.

Table 2-4 Applications (Continued)

Icon	Description
	YouTube - Use to view videos on the YouTube web site. TC51 with GMS only.
	Zebra Device Diagnostic Tool - Use this utility to determine the health of the TC51. Where appropriate, Zebra Help Desk uses the Diagnostic Tool for troubleshooting the device, relying on the results to provide the user with the most optimum steps to reach a prompt resolution. Available on builds BSP 19-01.4 and above.

Accessing Applications

All applications installed on the device are accessed using the **APPS** window.

1. On the Home screen, touch .

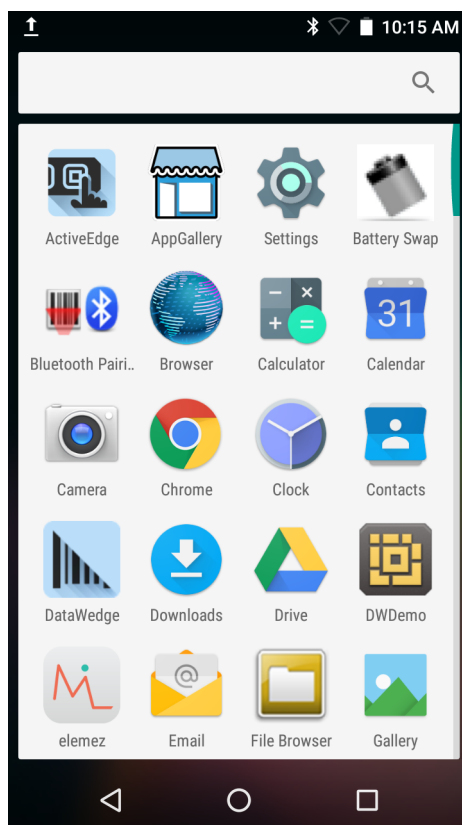
**Figure 2-13** APPS Window Example

2. Slide the **APPS** window left or right to view more application icons. Touch an icon to open the application.
See *Application Shortcuts and Widgets* on page 2-6 for information on creating a shortcut on the Home screen.

Switching Between Recent Applications

1. Touch and hold . A window appears on the screen with icons of recently used applications.

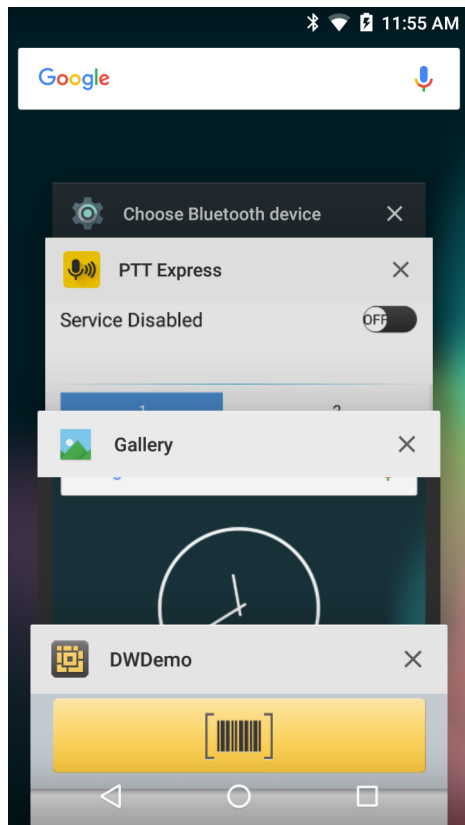



Figure 2-14 *Recently Used Applications*

2. Slide the window up and down to view all recently used applications.
3. Swipe left or right to remove application from the list and force close the application.
4. Touch an icon to open it or touch  to return to the current screen.

Un-Locking the Screen

Use the Lock screen to protect access to data on the TC51. Some email account require locking the screen. Refer to the *TC51 Touch Computer Integrator Guide for Android Version 6.0.1* for information on setting up the locking feature. The Locking feature functions differently in Single User mode or Multiple User mode.

When locked, a pattern, PIN or password is required to unlock the device. Press the Power button to lock the screen. The device also locks after a pre-defined time-out.

Press and release the Power button to wake the device.

The Lock screen displays. Slide  up to unlock the screen.

If the Pattern screen unlock feature is enabled, the Pattern screen appears instead of the Lock screen.

If the PIN or Password screen unlock feature is enabled, enter the PIN or password after unlocking the screen.

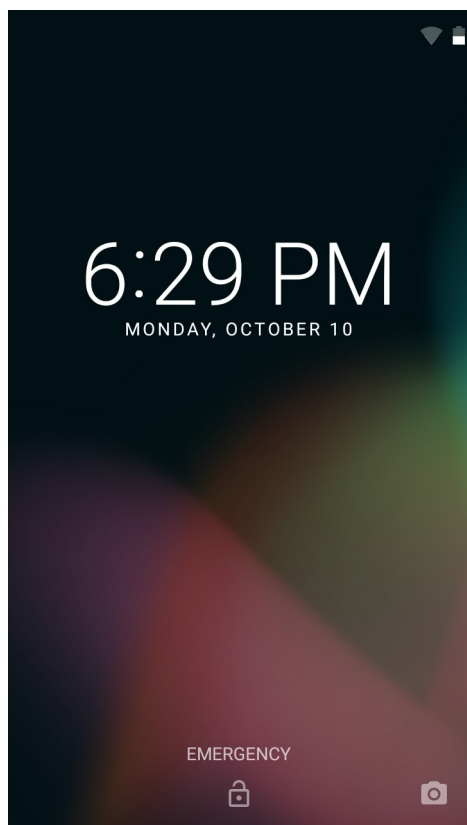

Figure 2-15 *Lock Screen*

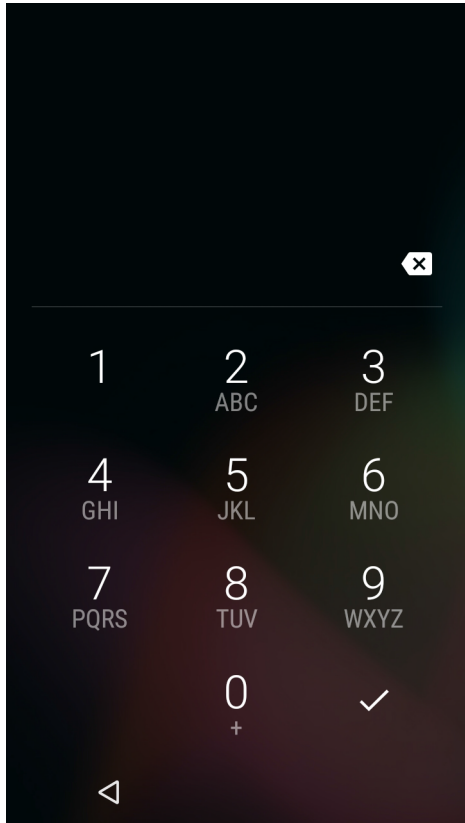

Figure 2-16 *PIN Screen*

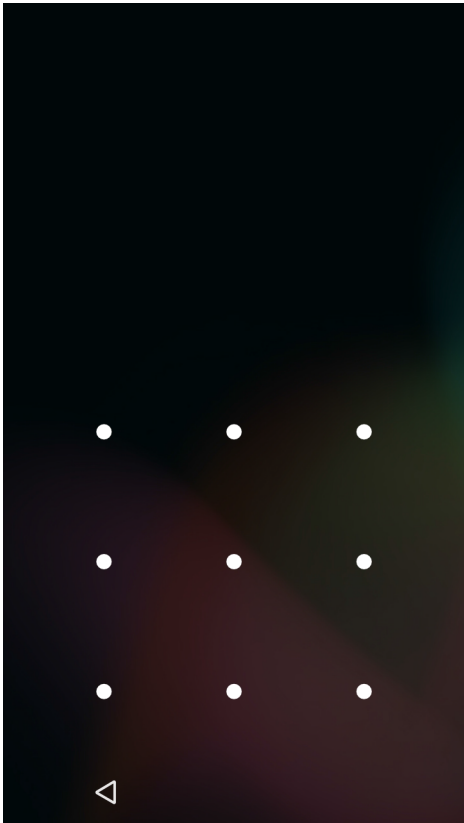

Figure 2-17 *Pattern Screen*

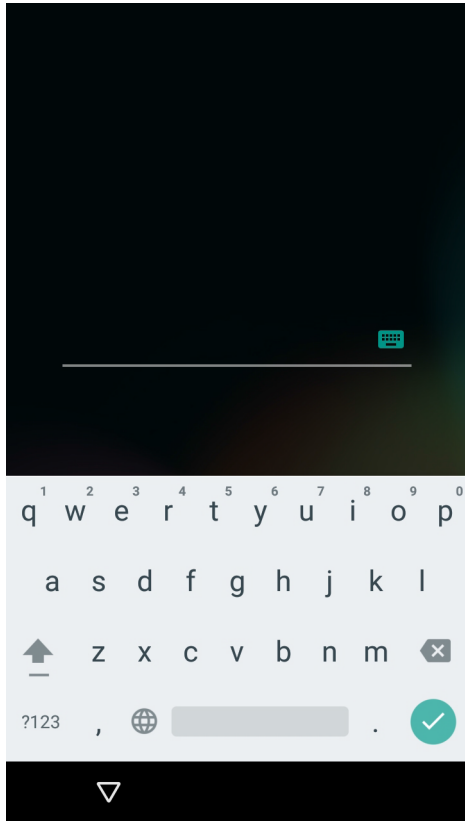

Figure 2-18 Password Screen

Resetting the Device

There are two reset functions, soft reset and hard reset.

Performing a Soft Reset

Perform a soft reset if applications stop responding.

1. Press and hold the Power button until the menu appears.
2. Touch **Reset**.
3. The device reboots.

Performing a Hard Reset



CAUTION Performing a hard reset with a microSD card installed in the TC51 may cause damage or data corruption to the microSD card.

Perform a hard reset if the TC51 stops responding.

1. Simultaneously press the Power, PTT and Volume Up buttons for at least four seconds.
2. When the screen turns off, release the buttons.
3. The TC51 reboots.

Suspend Mode

The TC51 goes into suspend mode when the user presses the Power button or after a period of inactivity (set in the Display settings window).

To wake the TC51 from Suspend mode, press the Power button.

The Lock screen displays. Slide  up to unlock the screen. If the Pattern screen unlock feature is enabled, the Pattern screen appears instead of the Lock screen. See *Un-Locking the Screen on page 2-18*.



NOTE If the user enters the PIN, password or pattern incorrectly five times, they must wait 30 seconds before trying again.

If the user forgets the PIN, password or pattern contact the system administrator.

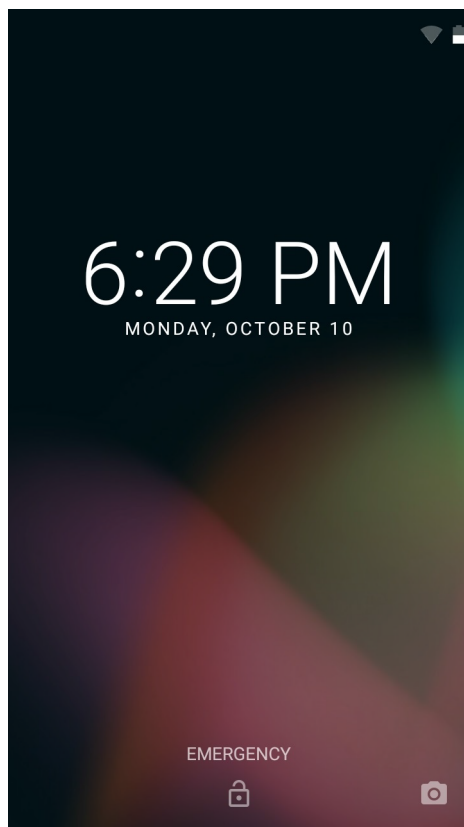

Figure 2-19 Lock Screen

Transferring Files with a Host Computer via USB

Connect the TC51 to a host computer using the USB Charging cable or the 1-Slot USB cradle to transfer files between the TC51 and the host computer. See [Chapter 6, Accessories](#) for more information.

When connecting the TC51 to a host computer, follow the host computer's instructions for connecting and disconnecting USB devices, to avoid damaging or corrupting files.

Transferring Files using Media Transfer Protocol

✓ **NOTE** Use Media Transfer Protocol (MTP) to copy files between the TC51 (internal memory or microSD card) and the host computer.

1. Connect the Rugged Charge/USB Cable to the TC51 or place the TC51 into the 1-Slot USB/Charge Only Cradle. See [Chapter 6, Accessories](#) for setup information.
2. Pull down the Notification panel and touch **USB for Charging**.

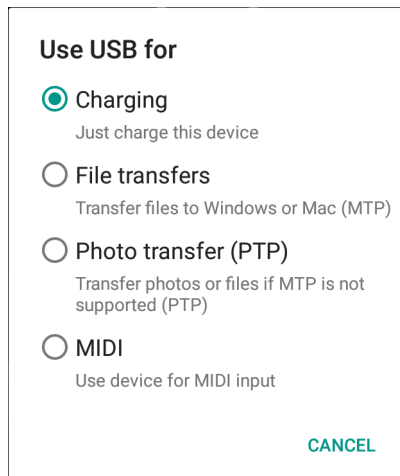

Figure 2-20 Use USB Dialog Box

3. Touch **File transfers**.
4. On the host computer, open a file explorer application.
5. Locate the **TC51** as a portable device.
6. Open the **SD card** or the **Internal storage** folder.
7. Copy files to and from the TC51 or delete files as required.

Transferring Files using Photo Transfer Protocol

✓ **NOTE** Use Photo Transfer Protocol (PTP) to copy photos from either the microSD card or internal memory to the host computer.

1. Connect the Rugged Charge/USB Cable to the TC51 or place the TC51 into the 1-Slot USB/Charge Only Cradle. See [Chapter 6, Accessories](#) for setup information.
2. Pull down the Notification panel and touch **USB for Charging**.

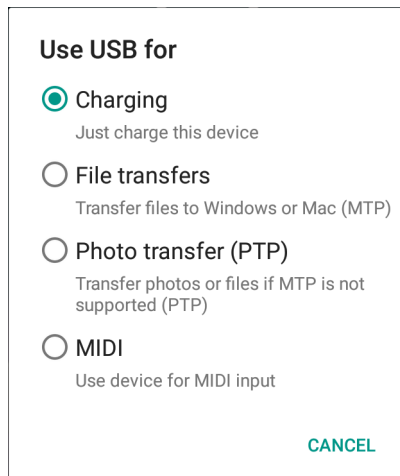

Figure 2-21 *Use USB Dialog Box*

3. Touch **Photo transfer (PTP)**.
4. On the host computer, open a file explorer application.
5. Open the **SD card** or the **Internal storage** folder.
6. Copy or delete photos as required.

Disconnect from the Host Computer



CAUTION Carefully follow the host computer's instructions to unmount the microSD card and disconnect USB devices correctly to avoid losing information.

1. On the host computer, unmount the device.
2. Remove the USB Charging cable from the device or remove the device from the cradle.

CHAPTER 3 APPLICATIONS

This section describes the applications installed on the device.

ActiveEdge Touch Zone

The **ActiveEdge Touch Zone** application provides configurable settings which enables quick and convenient one-touch access to key features or applications while users are in the middle of other applications or tasks. Once configured, soft keys near the perimeter of the display provide access to those frequently used applications or functions. ActiveEdge Touch Zone is available on builds BSP 19-01.4 and above.



NOTE The **ActiveEdge Touch Zone** is only available when the display is set to Portrait mode.

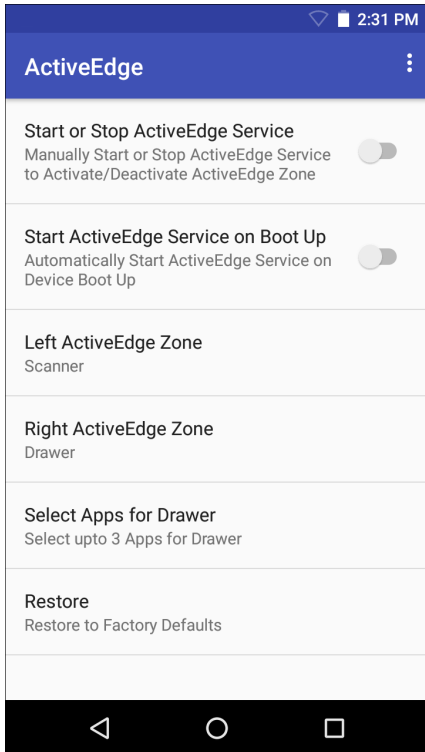

Figure 3-1 *ActiveEdge App Settings*

- **Start or Stop ActiveEdge Service** - Touch to start/stop the ActiveEdge Service to enable/disable the ActiveEdge Zone.
- **Start ActiveEdge Service on Boot Up** - Automatically start the ActiveEdge Service when the device boots up. the Service is always running and always available.
- **Left ActiveEdge Zone** - Configure the left ActiveEdge Zone to **Scanner**, **Drawer**, or **None**.
- **Right ActiveEdge Zone** - Configure the right ActiveEdge Zone to **Scanner**, **Drawer**, or **None**.
- **Select Apps for Drawer** - Select up to three applications to appear on the Drawer.
- **Restore** - Restore the settings to the factory defaults.

Select the Settings menu > **About** to open the **About ActiveEdge** window, which displays the version number.

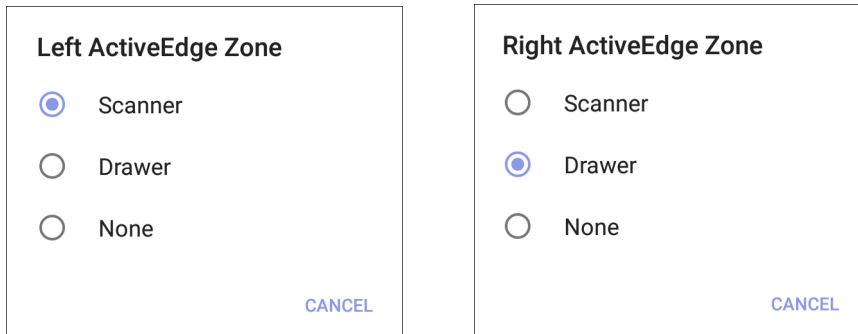



Figure 3-2 *Left and Right ActiveEdge Zones*

✓ **NOTE** The **Left ActiveEdge Zone** and the **Right ActiveEdge Zone** can be configured to any combination of **Scanner**, **Drawer**, or **None**, except that both zones cannot be configured to **Drawer**.

If the **Left ActiveEdge Zone** or the **Right ActiveEdge Zone** is set to **Drawer**, select **Select Apps for Drawer** from the Settings menu, select the menu options button , choose **Select Apps**, and choose up to three applications to appear on the **Drawer**.

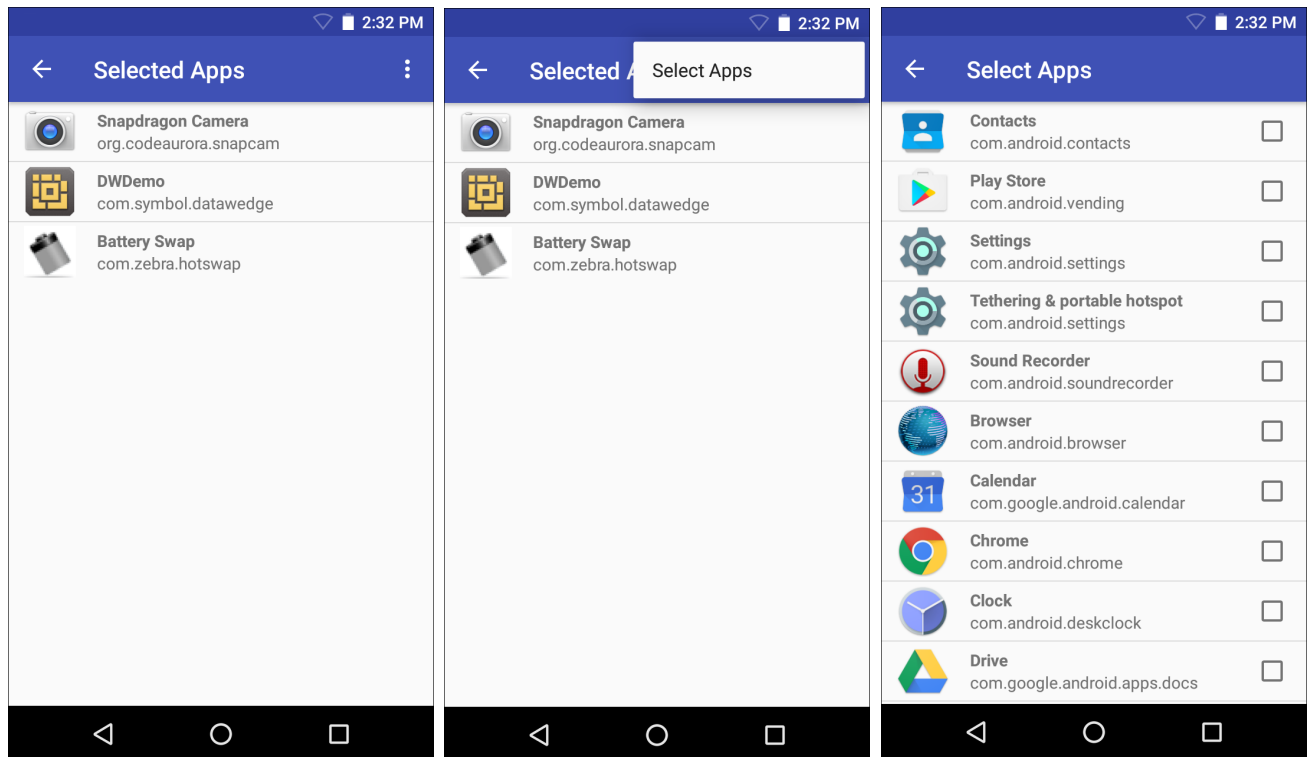

Figure 3-3 *Select Apps for Drawer*

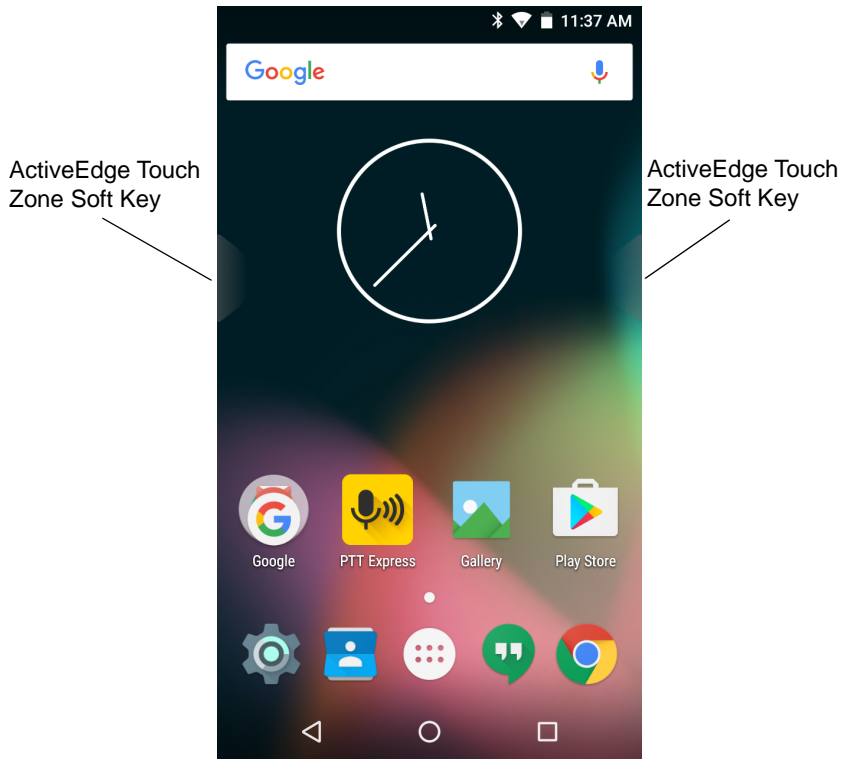

Figure 3-4 ActiveEdge Touch Zone Soft Key

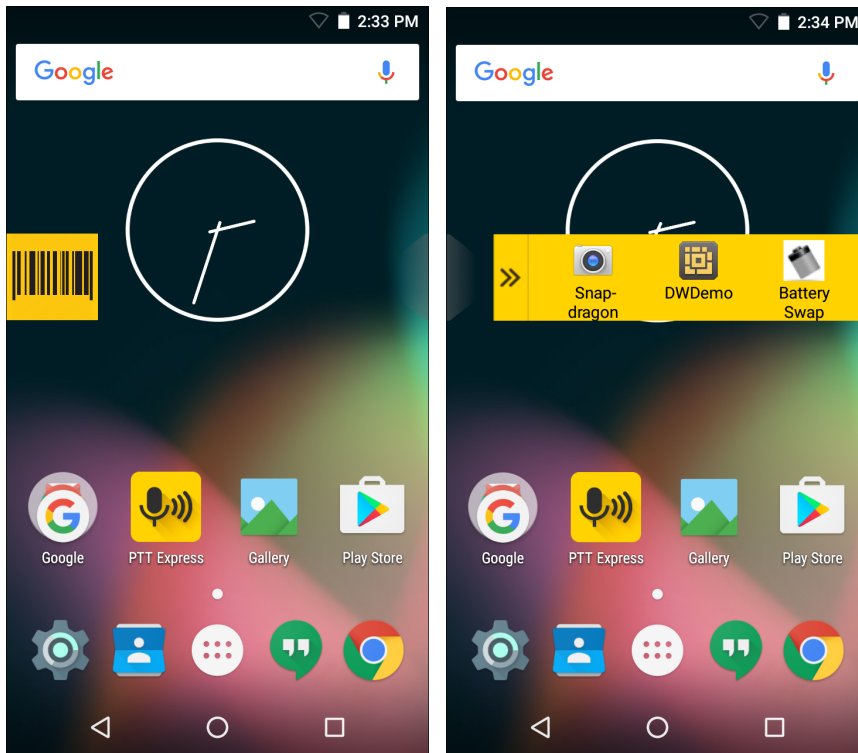

Figure 3-5 Left ActiveEdge Zone set to Scanner and Right ActiveEdge Zone set to Drawer

Battery Manager

The **Battery Manager** provides detailed information about the battery.

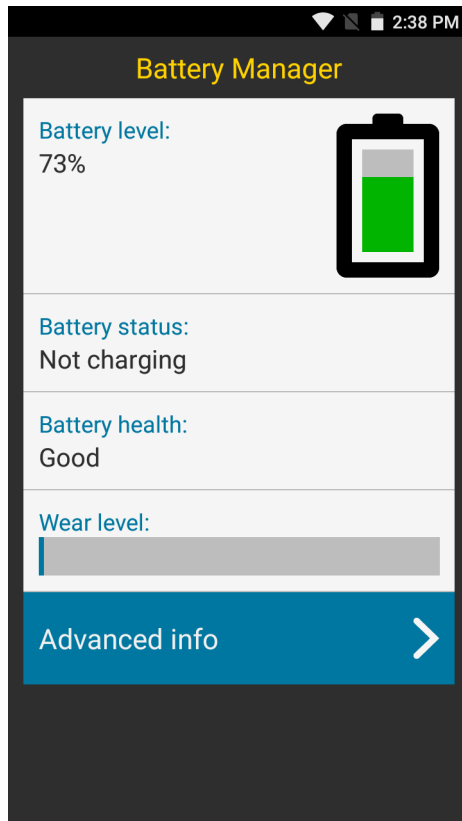





Figure 3-6 *Battery Manager Screen*

Table 3-1 *Battery Icon Description*

Battery Icon	Description
	Indicates battery charge level.
	Indicates battery charging.
	Indicates battery charge level is below 20%.

- **Battery level** - Indicate the current battery charge level as a percentage. Displays -% when level is unknown.

- **Battery status**
 - **Not charging** - Indicates that the device is not connected to AC power.
 - **Charging over AC** - Indicates that the device is connected to AC power and charging.
 - **Charging over USB** - Indicates that the device is connected to a host computer with a USB cable and charging.
 - **Discharging** - Indicates that the battery is discharging.
 - **Full** - Indicates that the battery is fully charged.
 - **Unknown** - Indicates that the battery status is unknown.
- **Battery health** - Indicates the health of the battery. If a critical error occurs,  appears. Touch to view error description.
 - **Decommission** - The battery is past its useful life and should be replaced. See system administrator.
 - **Good** - The battery is good.
 - **Charge error** - An error occurred while charging. See system administrator.
 - **Over Current** - An over-current condition occurred. See system administrator.
 - **Dead** - The battery has no charge. Replace the battery.
 - **Over Voltage** - An over-voltage condition occurred. See system administrator.
 - **Below Temperature** - The battery temperature is below the
 - **Failure Detected** - A failure has been detected in the battery. See system administrator.
 - **Unknown** - See system administrator.
- **Wear level** - Indicates the health of the battery in graphical form. When the wear level exceeds 80%, the bar color changes to red.

- **Advanced info** - Touch to view additional battery information.
 - **Battery present status** - Amount of usable charge remaining in the battery at present, under the current discharge conditions.
 - **Battery level** - Indicates battery charge level as a percentage of scale.
 - **Battery scale** - Battery scale level used to determine battery level (100).
 - **Battery voltage** - Indicates current battery voltage in millivolts.
 - **Battery temperature** - Indicates current battery temperature in degrees Centigrade.
 - **Battery technology** - Lists the type of battery.
 - **Battery Current** - Lists battery current in uA. (Available on builds BSP 19-01.4 and above).
 - **Battery manufacture date** - Lists the date of manufacture.
 - **Battery serial number** - Lists the battery serial number. The number matches the serial number printed on the battery label.
 - **Battery part number** - Lists the battery part number. The number matches the part number printed on the battery label.
 - **Battery rated capacity** - Lists the rated minimum capacity for the battery.
 - **Battery decommission status** - Lists the status of the battery as **Good** or **Decommissioned**. (Available on builds BSP 19-01.4 and above).
 - **Base cumulative charge** - Cumulative charge using Zebra charging equipment only.
 - **Battery present capacity** - Maximum amount of charge that could be pulled from the battery under the present discharge conditions if the battery were fully charged. (Available on builds BSP 19-01.4 and above).
 - **Battery health percentage** - With a range from **0** to **100**, this is the ratio of “present_capacity” to “design_capacity” at a discharge rate of “design_capacity”.(Available on builds BSP 19-01.4 and above).
 - **% decommission threshold** - Lists the default % decommission threshold for a gifted battery as 80%. (Available on builds BSP 19-01.4 and above).
 - **Battery present charge** - Amount of usable charge remaining in the battery at present under the current discharge conditions. (Available on builds BSP 19-01.4 and above).
 - **Battery total cumulative charge** - Lists the total accumulated charge in all chargers. (Available on builds BSP 19-01.4 and above).
 - **Battery time since first use** - Lists the time passed since the battery was placed in a Zebra terminal for the first time. (Available on builds BSP 19-01.4 and above).
 - **App version** - Lists the application version number.

File Browser

Use the **File Browser** application to view and manage files on the device.

To open **File Browser**, touch  > .

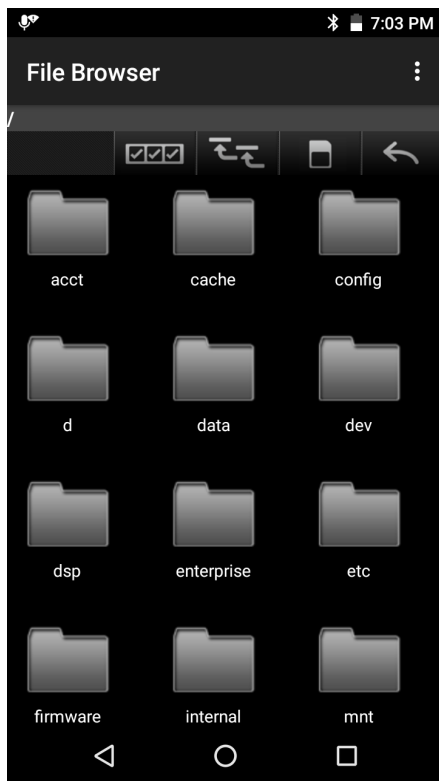



Figure 3-7 *File Browser Screen*

The address bar indicates the current folder path. Touch the current folder path to manually enter a path and folder name.

Use  to select multiple files/folder.

Use  to view the internal storage root folder.

Use  to view the microSD card root folder.

Use  to view the previous folder or to exit the application.

Touch and hold an item to perform an operation on that item. Select one of the options from the **File Operations** menu:

- **Information** - View detailed information about the file or folder.
- **Move** - Move the file or folder to a new location.
- **Copy** - Copy the select file.
- **Delete** - Delete the selected file.
- **Rename** - Rename the select file.
- **Open as** - Open the selected file as a specific file type.
- **Share** - Share the file with other devices.

Contacts

Use the **Contacts** application to manage contacts.

From a Home or Apps screen, touch . **People** opens to the main list of contacts. View contacts in three ways at the top of the screen: **Groups**, **All contacts**, and **Favorites**. Touch the tabs to change how to view the contacts. Swipe up or down to scroll through the lists.

Adding a Contact

1. In the **Contacts** application, touch .
2. If there are more than one account with contacts, touch the one to use.
3. Type the contact's name and other information. Touch a field to start typing, and swipe down to view all categories.
4. To open a menu with preset labels, such as **Home** or **Work** for an email address, touch the label to the right of the item of contact information. Or, to create your own label, touch **Custom** in the menu.
5. Touch the check mark next to **Add new contact**.

Editing Contacts

1. In the **Contacts** application, touch a contact name to edit.
2. Touch .
3. Edit the contact information.
4. Touch the check mark next to **Edit contact**.

Deleting Contacts

1. In the **Contacts** application, touch a contact name to delete.
2. Touch .
3. Touch **Delete**.
4. Touch **OK** to confirm.

Camera

This section provides information for taking photos and recording videos using the integrated digital cameras.

- ✓ **NOTE** If a microSD card is installed and the storage path is changed manually, the TC51 saves photos and videos on the microSD card. By default, or if a microSD card is not installed, the TC51 saves photos and videos on the internal storage.

Taking Photos

- ✓ **NOTE** Camera settings are described in *Photo Settings on page 3-13*.





1. Touch .
2. Touch .



Figure 3-8 Camera Mode

3. If necessary, touch the Camera Mode icon and touch .
4. Frame the subject on the screen.

5. To zoom in or out, press two fingers on the display and pinch or expand fingers. The zoom controls appear on the screen.
6. Touch an area on the screen to focus. The focus circle appears on the screen. The two bars turn green when in focus.
7. Touch .
The camera takes a photo and a shutter sound plays.
The photo momentarily displays as a thumbnail in the lower left corner.



Taking a Panoramic Photo

Panorama mode lets the user create a single wide image by panning slowly across a scene.

1. Touch .
2. Touch .





Figure 3-9 *Panoramic Mode*

3. Touch the Camera Mode and touch .
4. Frame one side of the scene to capture.
5. Touch  and slowly start panning across the area to capture. A small white square appears inside the button indicating the capture is in progress.
If panning too quickly, the message **Too fast** appears.

6. Touch  to end the shot. The panorama appears immediately and a progress indicator displays while it saves the image.

Recording Videos

To record a video:

1. Touch .
2. Touch .
3. Touch the options bar and touch .

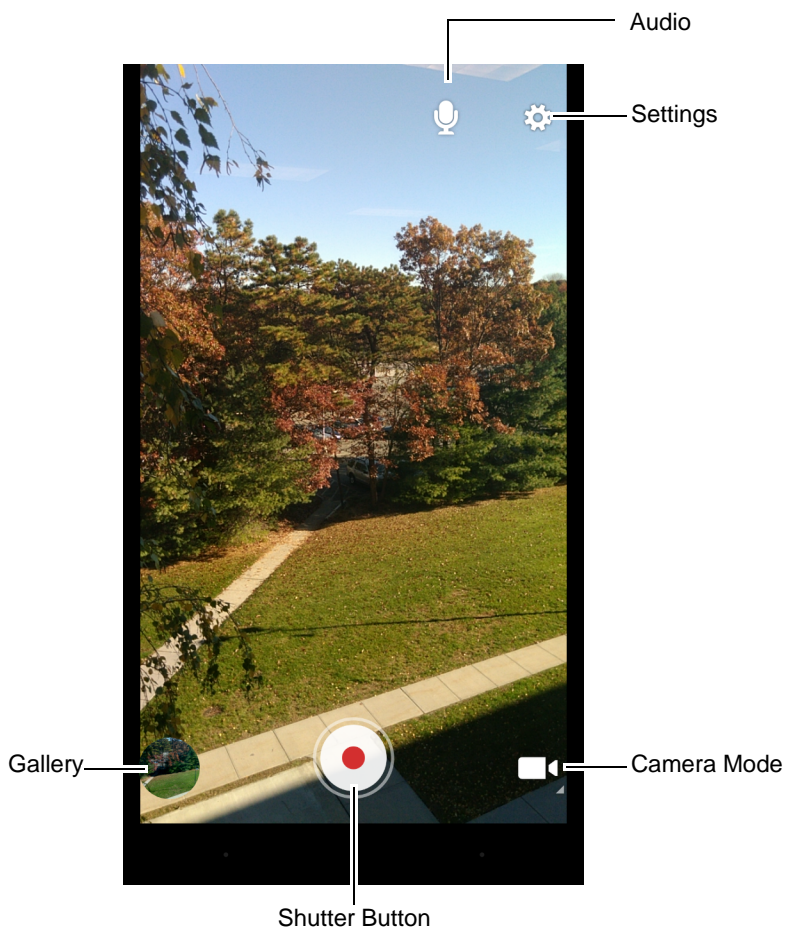

Figure 3-10 Video Mode













4. Point the camera and frame the scene.
5. To zoom in or out, press two fingers on the display and pinch or expand fingers. The zoom controls appear on the screen.
6. Touch  to start recording.
The device starts recording the video. The video time remaining appears in the top left of the screen.
7. Touch  to end recording.
The video momentarily displays as a thumbnail in the lower left corner.



Photo Settings





When in Photo mode, photo settings are displayed on screen. Touch  to display the photo settings options.

- **Flash** - Touch to set whether the camera relies on its light meter to decide whether a flash is necessary, or to turn it on or off for all shots.
 -  **Off** - Disable flash.
 -  **Auto** - Camera adjusts flash automatically depending upon light meter (default).
 -  **On** - Enable flash upon taking a photo.
 -  **Torch** - Turn flash on continuously.
- **Picture size** - Touch to set the size (in pixels) of the photo. Options: **13M pixels** (default), **8M pixels**, **5M pixels**, **3M pixels**, **HD 1080**, **2M pixels**, **HD 720**, **1M pixels**, **WVGA**, **VGA**, or **QVGA**.
- **Picture quality** - Touch to select picture quality setting. Options: **Low**, **Standard** (default) or **High**.
- **Countdown timer** - Options: **Off** (default), **2 seconds**, **5 seconds** or **10 seconds**.
- **Storage** – Touch to select location to store the photo. Options: **Phone** or **SD Card**.
- **Face Detection** - Select to enable face detection. Options: **Off** (default) or **On**.
- **ISO** - Set how sensitive the camera is to light. Options: **Auto** (default), **ISO Auto (HJR)**, **ISO100**, **ISO200**, **ISO400**, **ISO800** or **ISO1600**.
- **Exposure** - Touch to adjust the exposure settings. Options: **+2**, **+1**, **0**(default), **-1** or **-2**.
- **White balance** - Touch to select how Camera adjusts colors in different kinds of light, to achieve the most natural-looking colors.
 -  **Incandescent** - Adjust the white balance for incandescent lighting.
 -  **Fluorescent** - Adjust the white balance for florescent lighting.
 -  **Auto** - Adjust the white balance automatically (default).
 -  **Daylight** - Adjust the white balance for daylight.
 -  **Cloudy** - Adjust the white balance for a cloudy environment.
- **Focus mode** - Touch to select the camera focus setting. Options: **Auto**, **Infinity**, **Macro** or **CAF** (Continuous Auto Focus) (default).
- **ZSL** - Set the camera to immediately take a picture when the button is pressed (default – enabled)

Video Settings

When in Video mode, video settings are displayed on screen. Touch  to display the video settings options.

- **Flash** - Touch to set whether Rear-facing Camera relies on its light meter to decide whether a flash is necessary, or to turn it on or off for all shots.
 -  **Off** - Disable flash (default).
 -  **Torch** - Turn flash on continuously.
- **Video quality** - Touch to select video quality. Options: **HD 1080p** (default), **HD 720p**, or **SD 480p**.
- **Video duration** - Options: **30 seconds (MMS)** or **30 minutes** (default).
- **Storage** – Touch to select location to store the photo. Options: **Phone** (default) or **SD Card**.

- **White balance** - Touch to select how Camera adjusts colors in different kinds of light, to achieve the most natural-looking colors.
 -  **Incandescent** - Adjust the white balance for incandescent lighting.
 -  **Fluorescent** - Adjust the white balance for florescent lighting.
 -  **Auto** - Adjust the white balance automatically (default).
 -  **Daylight** - Adjust the white balance for daylight.
 -  **Cloudy** - Adjust the white balance for a cloudy environment.

Gallery



NOTE The device supports the following image formats: jpeg, gif, png and bmp.



The device supports the following video formats: H.263, H.264 and MPEG4 Simple Profile.

Available on TC51 with GMS only.

Use Gallery to:

- view photos
- play videos
- perform basic editing of photos
- set photos as wallpaper
- set photos as a contact photo
- share photos and videos.

Gallery presents all photos and videos stored on the microSD card and internal memory.

To open the Gallery application, touch  >  or in the camera application touch the thumbnail image at the bottom left.

By default, Gallery opens to the **Timeline** view.

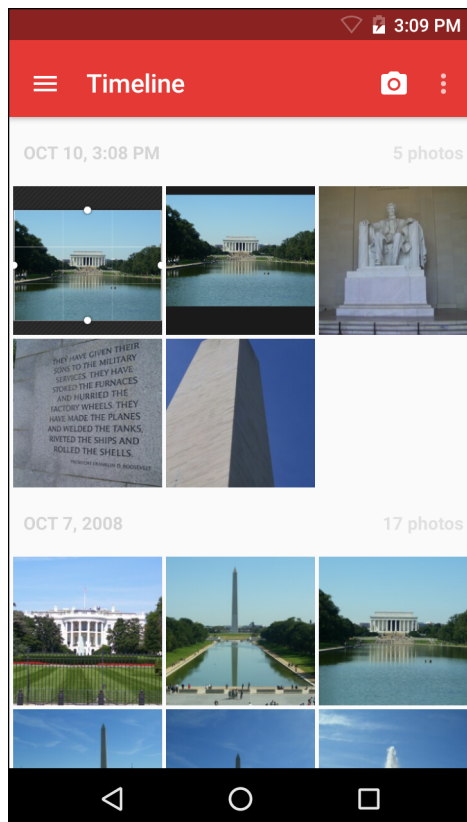



Figure 3-11 Gallery - Timeline View

Touch  > **Albums** to view photos sorted by albums or  > **Videos** to view only videos.

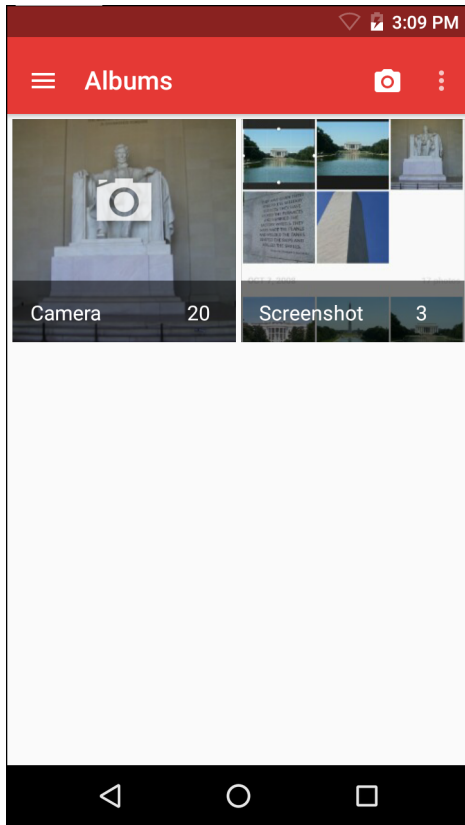



Figure 3-12 *Gallery — Albums*

- Touch an album to open it and view its contents. The photos and videos in the album are displayed in chronological order.
- Touch a photo or video in an album to view it.
- Touch  to return to the main **Gallery** screen.

Working with Albums



Albums are groups of images and videos in folders. Touch an album to open it. The photos and videos are listed in a chronologically ordered grid. The name of the album displays at the top of the screen.





Figure 3-13 *Photos Inside an Album*

Swipe left or right to scroll images across the screen.

Share an Album

1. Touch  > .
2. Touch and hold an album until it highlights.
3. Touch other albums as required.
4. Touch . The Share menu opens. Touch the application to use to share the selected albums.
5. Follow the instructions within the selected application.

Get Album Information

1. Touch  > .
2. Touch and hold an album until it highlights.
3. Touch .
4. Touch **Details**.

Deleting an Album

To delete an album and its contents:

1. Touch  > .



2. Touch and hold an album until it highlights.
3. Check other albums to delete. Ensure that other albums are selected.
4. Touch .
5. In the **Delete selected item?** menu, touch **OK** to delete the album.

Working with Photos

Use Gallery to view photos on the microSD card and edit and share photos.

Viewing and Browsing Photos

To view a photo:

1. Touch  > .
2. Touch an album to open it.
3. Touch a photo.

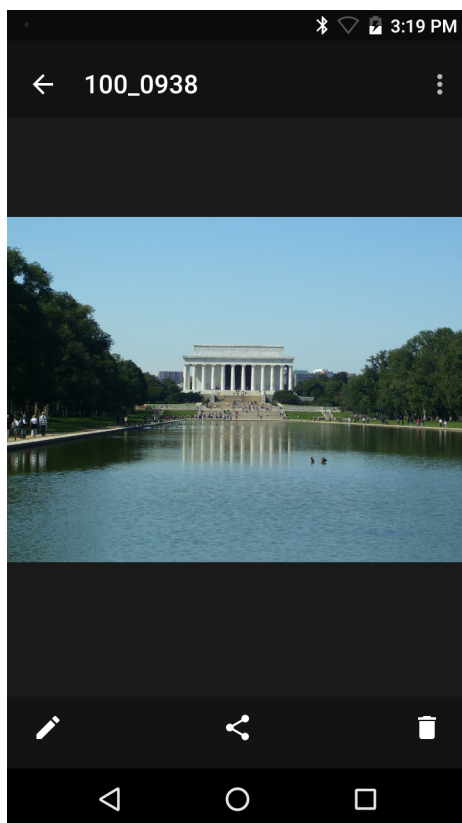



Figure 3-14 *Photo Example*

4. Swipe left or right to view the next or previous photo in the album.
5. Turn the device to view the photo in upright (portrait) or sideways (landscape) orientation. The photo is displayed (but not saved) in the new orientation.
6. Touch the photo to view the controls.
7. Double-tap the screen to zoom in or pinch two fingers together or spread them apart to zoom in or out.
8. Drag the photo to view parts that are not in view.

Cropping a Photo

1. In Gallery, touch a photo to view the controls.
2. Touch  > **Crop**. The cropping tool appears.
3. Use the cropping tool to select the portion of the photo to crop.
 - Drag from the inside of the cropping tool to move it.
 - Drag an edge of the cropping tool to resize it to any proportion.

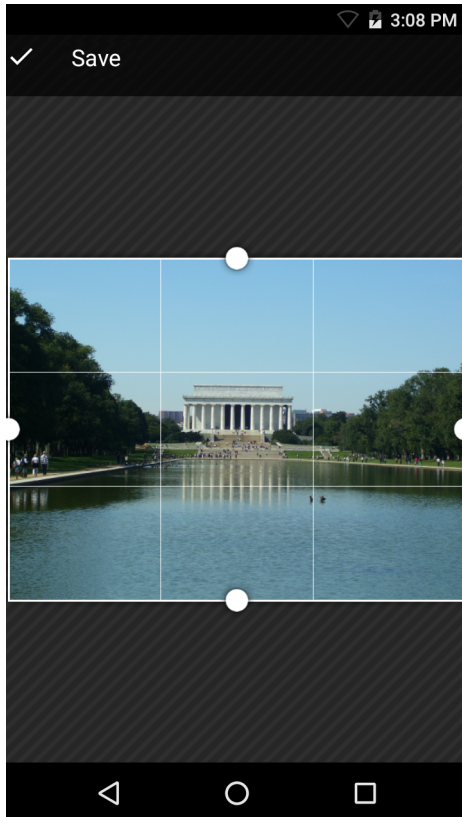







Figure 3-15 *Cropping Tool*

4. Touch **Save** to save a copy of the cropped photo. The original version is retained.



Setting a Photo as a Contact Icon

1. Touch  > .
2. Touch an album to open it.
3. Touch the photo to open it.
4. Touch .
5. Touch **Set picture as**.
6. Touch **Contact photo**.
7. In the **People** application, touch a contact.
8. Touch the white box and crop the photo accordingly.
9. Touch **Save**.

Share a Photo

1. Touch  > .
2. Touch an album to open it.
3. Touch a photo to open it.
4. Touch .
5. Touch the application to use to share the selected photo. The application selected opens with the photo attached to a new message.



Deleting a Photo

1. Touch  > .
2. Touch an album to open it.
3. Touch a photo to open it.
4. Touch .
5. Touch **Delete**.
6. Touch **OK** to delete the photo.



Working with Videos

Use **Gallery** to view videos and share videos.



Watching Videos

1. Touch  > .
2. Touch an album to open it.
3. Touch a video.
4. Touch . The video begins to play.
5. Touch the screen to view the playback controls.

Sharing a Video

1. Touch  > .
2. Touch an album to open it.
3. Touch a video to open it.
4. Touch . The Share menu appears.
5. Touch the application to use to share the selected video. The application selected opens with the video attached to a new message.

Deleting a Video

1. Touch  > .
2. Touch an album to open it.
3. Touch a video to open it.
4. Touch .

5. Touch **Delete**.
6. Touch **OK**.

DataWedge Demonstration



NOTE DataWedge is enabled by default when the Home screen displays, but you cannot scan from the Home screen since the **Launcher** profile is disabled. To enable the **Launcher** profile, go to the DataWedge settings, select **Launcher**, and check the **Profile enabled** checkbox. To disable DataWedge, go to the DataWedge settings and uncheck the **Enable/disable DataWedge** checkbox.

Use **DataWedge Demonstration** to demonstrate data capture functionality.

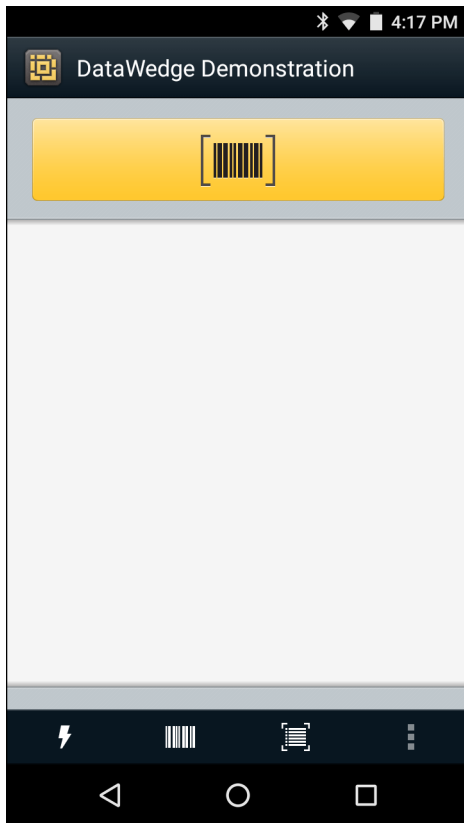





Figure 3-16 DataWedge Demonstration Window

Table 3-2 DataWedge Demonstration Icons

Icon	Description
	Toggles illumination on and off when using the imager to capture bar code data.
	Toggles the data capture function between the internal imager, RS507 Hands-free Bluetooth imager (if connected), RS6000 Ring Scanner, or DS3678 Digital Scanner. The RS6000 Ring Scanner and DS3678 Digital Scanner is available on builds BSP 16-04 and above.

Table 3-2 *DataWedge Demonstration Icons (Continued)*

Icon	Description
	Toggles between normal scan mode and picklist mode when using the imager to capture bar code data.
	Opens a menu to view the application information or to set the application DataWedge profile.

 **NOTE** See the *TC51 Touch Computer Integrator Guide for Android Version 6.0.1* for information on DataWedge configuration.

Either press the programmable button or touch the yellow scan button to enable data capture. The captured data appears in the text field below the yellow button.

Sound Recorder

Use **Sound Recorder** to record audio messages.

Recordings are saved on the microSD card (if installed) or the Internal Storage and available in the Music application playlist titled "Audio Recordings."

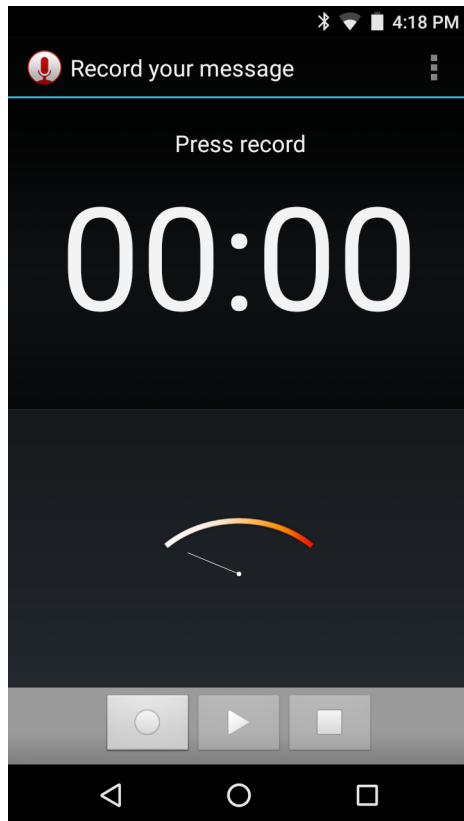

Figure 3-17 *Sound Recorder Application*

PTT Express Voice Client



NOTE PTT Express Voice Client creates Push-To-Talk (PTT) communication capability between disparate enterprise devices. Leveraging existing Wireless Local Area Network (WLAN) infrastructure, PTT Express delivers simple PTT communication without the need of a voice communication server.

- **Group Call:** Press and hold the PTT button to start communicating with other voice client users.
- **Private Response:** Double-press and the PTT button to respond to the originator of the last broadcast or to make a Private Response.

PTT Audible Indicators

The following tones provide helpful cues when using the voice client.

- **Talk Tone:** Double chirp. Plays when the Talk button is depressed. This is a prompt for the user to start talking.
- **Access Tone:** Single beep. Plays when another user just finished a broadcast or response. The user is now able to initiate a Group Broadcast or Private Response.
- **Busy Tone:** Continuous tone. Plays when the Talk button is depressed and another user is already communicating on the same talkgroup. Plays after the maximum allowed talk time is reached (60 seconds).
- **Network Tone:**
 - Three increasing pitch beeps. Plays when PTT Express has acquired the WLAN connection and the service is enabled.
 - Three decreasing pitch beeps. Plays when PTT Express has lost the WLAN connection or the service is disabled.

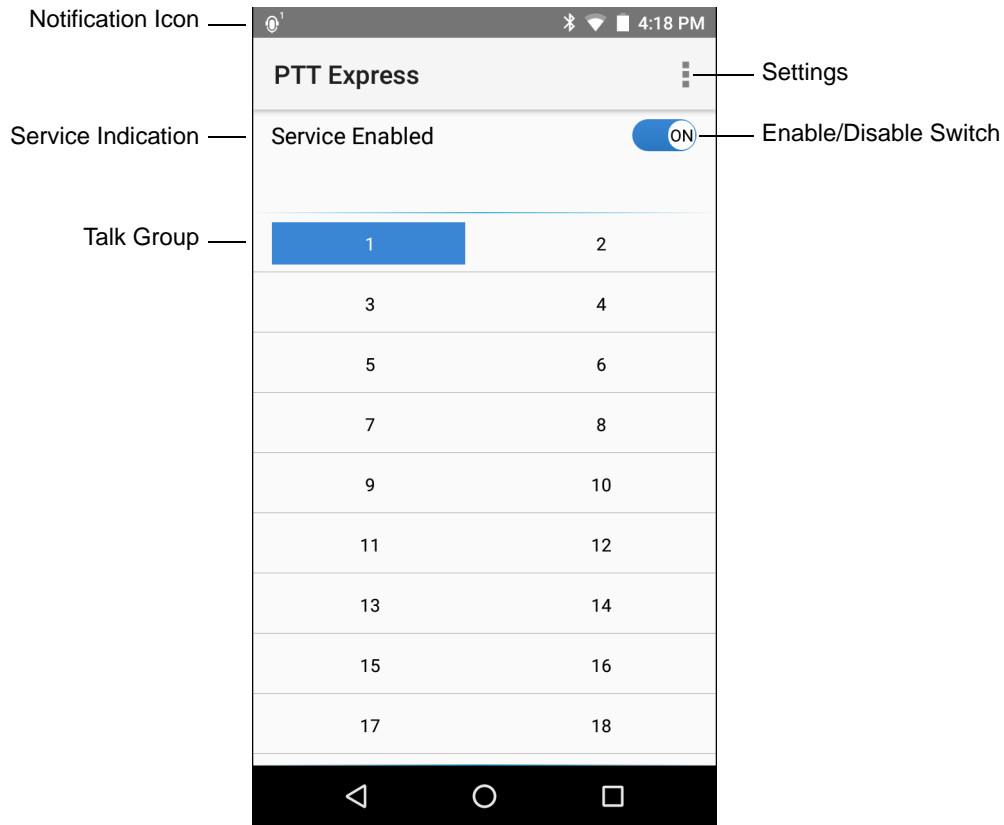

Figure 3-18 PTT Express Default User Interface







Table 3-3 PTT Express Default User Interface Descriptions

Item	Description
Notification Icon	Indicates the current state of the PTT Express client.
Service Indication	Indicates the status of the PTT Express client. Options: Service Enabled , Service Disabled or Service Unavailable .
Talk Groups	Lists all 32 Talk Groups available for PTT communication.
Settings	Opens the PTT Express Settings screen.
Enable/Disable Switch	Turns the PTT service on and off.

Notification Icons

Indicates the current state of the PTT Express Voice client.

Table 3-4 PTT Express Default User Interface Descriptions

Status Icon	Description
	Indicates that PTT Express Voice client is disabled.
	Indicates that PTT Express Voice client is enabled but not connected to a WLAN.
	Indicates that PTT Express Voice client is enabled, connected to a WLAN and listening on the Talk Group indicated by the number next to the icon.
	Indicates that PTT Express Voice client is enabled, connected to a WLAN and communicating on the Talk Group indicated by the number next to the icon.
	Indicates that PTT Express Voice client is enabled, connected to a WLAN and in a private response.
	Indicates that PTT Express Voice client is enabled and muted.
	Indicates that the PTT Express Voice client is enabled but it is not able to communicate due to a VoIP telephony call is in progress.

Enabling PTT Communication

1. Touch .
2. Touch .
3. Slide the **Enable/Disable Switch** to the **ON** position. The button changes to an **ON** button.

Selecting a Talk Group

One of 32 Talk Groups can be selected by PTT Express users. However, only one talk group may be enabled at a time on the device. Touch one of the 32 Talk Groups. The selected Talk Group is highlighted.

PTT Communication



NOTE This section describes the default PTT Express client configuration. See the *PTT Express V1.2 User Guide* for detailed information on using the client.

PTT communication may be established as a Group Call. When PTT Express is enabled, the PTT button on the left side of the device is assigned for PTT communication. When the Wired Headset is used, Group Calls can also be initiated using the headset Talk button.

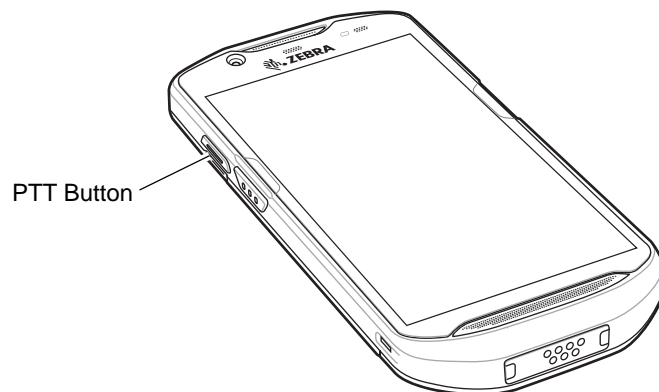

Figure 3-19 PTT Buttons

Creating a Group Call

1. Press and hold the PTT button (or the Talk button on the headset) and listen for the talk tone to play.
If a busy tone is heard, release the button and wait a moment before making another attempt. Ensure that PTT Express and the WLAN are enabled.
2. Start talking after the talk tone is heard.



NOTE If the user holds the button for more than 60 seconds (default), the call is dropped allowing others to make Group calls. The user should release the button when finished talking to allow others to make calls.

3. Release the button when finished talking.

Responding with a Private Response

The Private Response can only be initiated once a Group Call has been established. The initial Private Response is made to the originator of the Group Call.

1. Wait until an access tone is heard.
2. Within 10 seconds, double-press the PTT button, and listen for the talk tone to play.
3. If a busy tone is heard, release the button and wait a moment before making another attempt. Ensure that PTT Express and the WLAN are enabled.
4. Start talking after the talk tone plays.
5. Release the button when finished talking.

Disabling PTT Express Voice Client Communication

1. Touch .
2. Touch .
3. Slide the **Enable/Disable Switch** to the **OFF** position. The button changes to **OFF**.
4. Touch .

RxLogger

RxLogger is a comprehensive diagnostic tool that provides application and system metrics. It allows for custom plug-ins to be created and work seamlessly with this tool. RxLogger is used to diagnose device and application issues. Its information tracking includes the following: CPU load, memory load, memory snapshots, battery consumption, power states, wireless logging, cellular logging, TCP dumps, Bluetooth logging, GPS logging, logcat, FTP push/pull, ANR dumps, etc. All logs and files generated are saved onto flash storage on the device (internal or external).

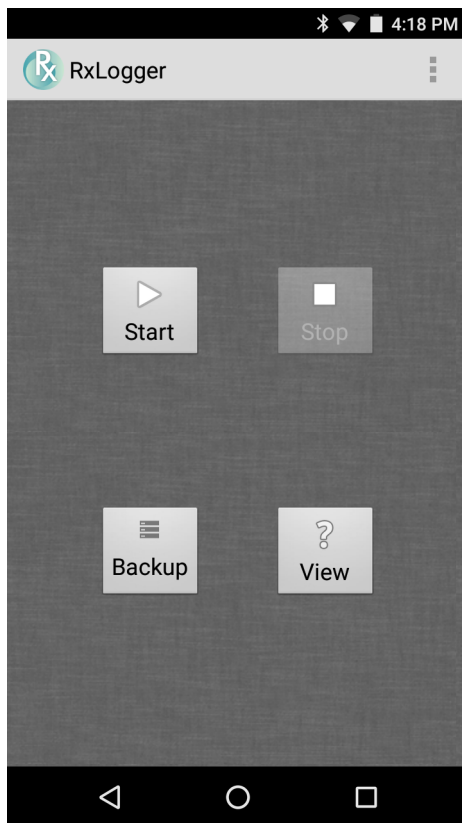

Figure 3-20 RxLogger

SimulScan Demo

The SimulScan application is an out of the box demonstration application included on the device that support SimulScan. The application enables pre-sales personnel to showcase the various features of SimulScan to customers by employing use-cases in the two most popular verticals, Postal/Transportation and Logistics and Manufacturing. The Transportation and Logistics example showcases the OCR and OMR features. The Manufacturing example showcases the MultiCode 20 feature. SimulScan also allows customers to create templates using the Template Builder and then testing on the device.

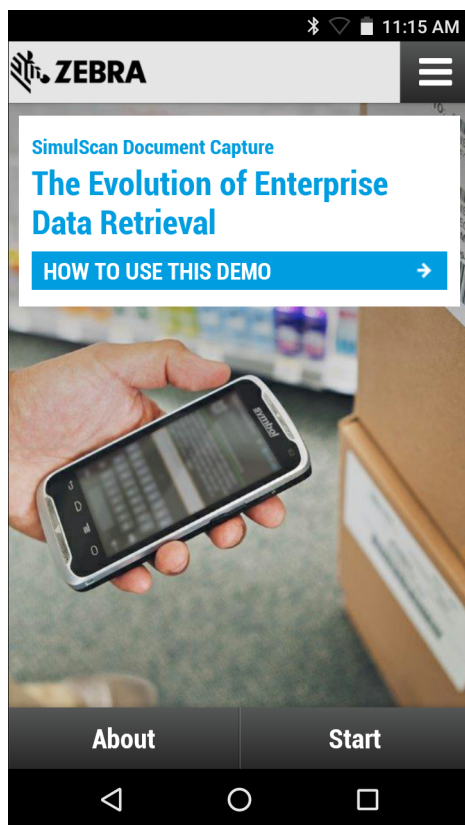

Figure 3-21 *SimulScan Demo Home Screen*

Exporting Sample Forms

In order to perform the Postal, Transportation & Logistics or Manufacturing demonstrations, print the example forms stored on the device.

1. Launch **SimulScan Demo** application.
2. On the **SimulScan Demo** home screen, touch **HOW TO USE THIS DEMO**.
3. Scroll down and touch **Export sample forms** button. The device copies the forms to the `\simulscan\samples` folder in Internal Storage.
4. Connect the device to a computer using the USB Charging cable.
5. Copy the files from the `\simulscan\samples` folder in Internal Storage to the computer.
6. Print the forms.

Postal, Transportation and Logistics Example

The Postal, Transportation and Logistics example uses the following form.:

1 Paper account number and insurance details

Change to Shipper Receiver Self-pay
Not all optional features are available in all countries

Paper Account No. 001-1234976

Shipment Insurance see manual
 Yes (insurance value in local currency) 100

2 Non-document Shipments Only (optional)

Match the original and fax copies of a document or Commercial Invoice

Shipper's WTI/CSI number 564451112 Receiver's WTI/CSI or Shipper's EUN/SSN 111517738

Destination duties/taxes (if not been received per addressee)
 Receiver Shipper Other specify amount and currency

Shipment at Retail (Not applicable)

123456789A

3 From Shipper

Shipper's account number 135-22243

Company name Pure Theory Ltd

Address 131B Lansdowne Drive
 Fitzrovia, London
 England
 WC2 1AB

Contact name Phone Fax or Email (required)
 Scott Anderson 020 553833

4 To Receiver

Company name TFV Solutions

Delivery address do not delete to a P.O. Box
 Schalla
 Trondheim
 72164 Brønnoya

Postcode/Zip Code required 288 32 Country Sweden

Contact person Phone Fax or Email (required)
 Aidan Peterson +46 8 123 89 67

5 Shipper's agreement

Signature required
 I/We, the undersigned, hereby agree to the terms and Conditions of Carriage shown hereon and I/We also hereby accept and undertake to pay the Charges and/or outside liability for loss, damage or delay and I/We accept that the Carrier shall be discharged from all liability for loss, damage or delay to the goods sent hereon.

Signature _____

Date 10 / 10 / 13

For more information see the website or call our local office

Figure 3-22 Postal, Transportation and Logistics Form

1. Place the form on a flat surface.
2. On the device, launch **SimulScan Demo** application.
3. Touch the **Menu** icon in the top right corner of the screen.
4. Touch **Postal, Transportation & Logistics**.
5. Touch **Start SimulScan**.
6. Use the image control at the bottom of the screen to control the flash, audio and zoom level.



Figure 3-23 Image Controls

7. Position the camera over the form. Ensure that the complete border of the form is visible on the screen.
8. Hold the device steady.
9. Once the device detects the form **Tap Screen to Scan** appears on the screen.
10. Tap the screen to start the data capture. When completed, the device beeps and the data from the form displays.

Field	Parsed Data
Barcode	123456-789A
Charge To	<input checked="" type="checkbox"/>
Account Number	155-22263
Shipper Name	<div style="background-color: red; color: white; padding: 2px;">▲ Check Result</div> Pure Theory Ltd
Shipper Address	<div style="background-color: red; color: white; padding: 2px;">▲ Check Result</div> 1631 LaDWS@Bwn Drive Fitzrovia, London

Rescan | Accept

Figure 3-24 *Postal Data Screen*

11. Touch the text boxes to correct any errors. Note: if there are too many errors, touch **Rescan** to perform the capture again.
12. Touch **Accept** to confirm the data is correct. The **Results summary** screen appears.
13. Touch **OK**.

Manufacturing Example

The Postal, Transportation and Logistics example uses the following form:.

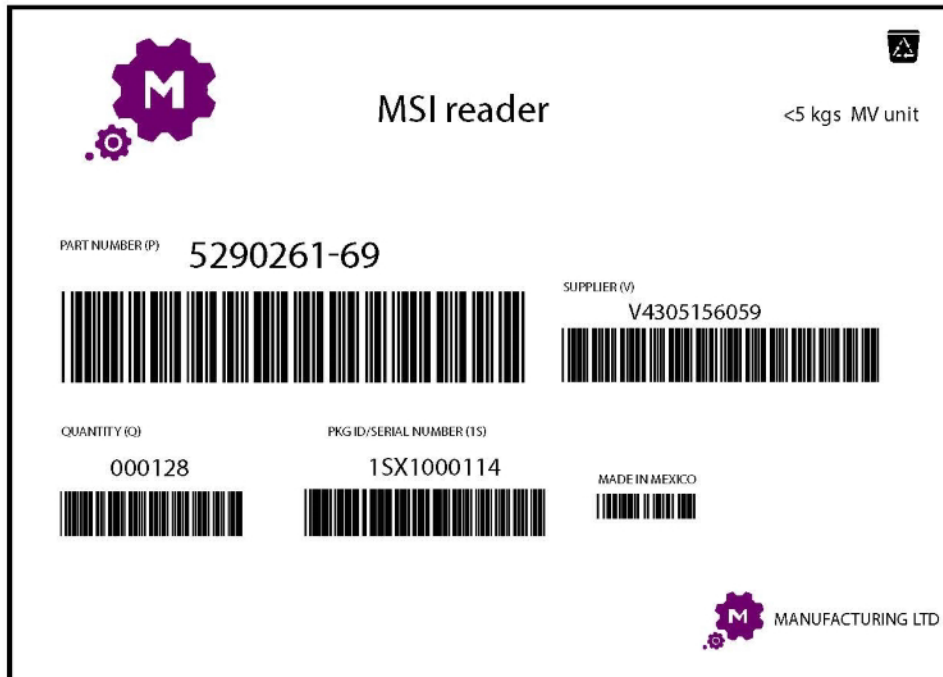

The image shows a 'Manufacturing Form' for an 'MSI reader'. The form is enclosed in a black border and contains the following information:

- Top Left:** A purple gear icon with a white 'M' inside.
- Top Center:** The text 'MSI reader'.
- Top Right:** A small black icon of a triangle with a white 'A' inside, and the text '<5 kgs MV unit'.
- Part Information:**
 - PART NUMBER (P):** 5290261-69, with a large barcode below it.
 - SUPPLIER (V):** V4305156059, with a smaller barcode below it.
- Quantity and Package Information:**
 - QUANTITY (Q):** 000128, with a small barcode below it.
 - PKG ID/SERIAL NUMBER (15):** 1SX1000114, with a medium-sized barcode below it.
 - MADE IN MEXICO:** A small barcode below the text.
- Bottom Right:** A purple gear icon with a white 'M' inside, followed by the text 'MANUFACTURING LTD'.

Figure 3-25 *Manufacturing Form*

1. Copy the sample form from the device to a computer. See
2. Print this form.
3. Place the form on a flat surface.
4. On the device, launch **SimulScan Demo** application.
5. Touch the **Menu** icon in the top right corner of the screen.
6. Touch **Manufacturing**.
7. Touch **Start SimulScan**.
8. Point the top of the device at the document and center the target on the document.
9. Hold the device steady.
10. The device starts the data capture. When completed, the device beeps and the data from the document displays.

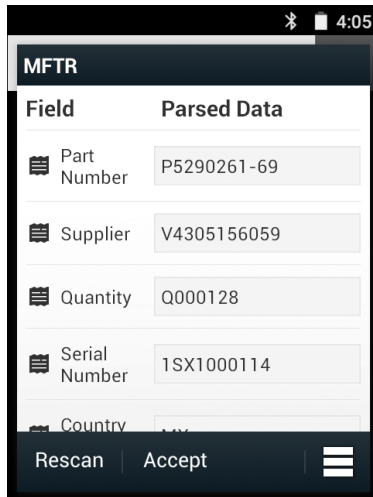

Figure 3-26 *Manufacturing Data*

11. Touch the text boxes to correct any errors. If there are too many errors, touch **Rescan** to perform the capture again.
12. Touch **Accept** to confirm the data is correct. The **Results summary** screen appears.
13. Touch **OK**.

Settings

To set the settings for the **SimulScan Demo** application touch **Menu** icon > **Settings**.

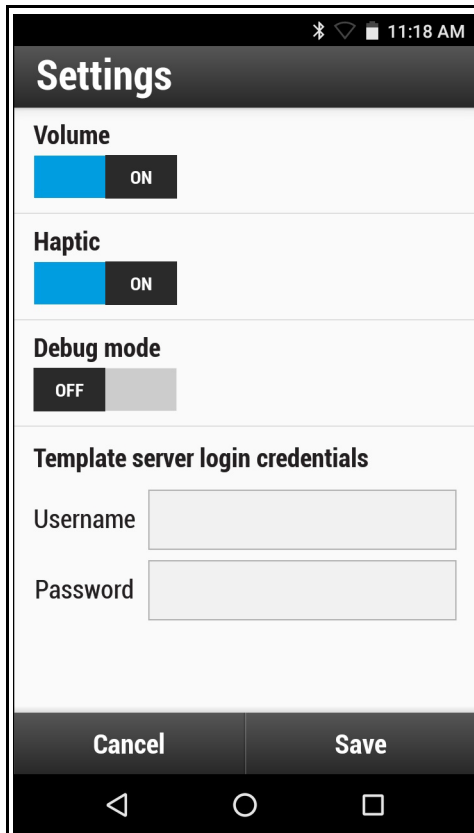



Figure 3-27 Settings Screen

- **Volume** - Toggle switch to turn audible notification on and off.
- **Haptic** - Toggle switch to turn vibration notification on and off.
- **Debug mode** - Toggle switch to enable or disable debug mode.
- **Template server login credentials** - enter credentials for accessing the template server.

Advanced Settings

Use the Advanced setting to configure data capture options. In the data capture screen, touch  in the bottom right corner of the screen.

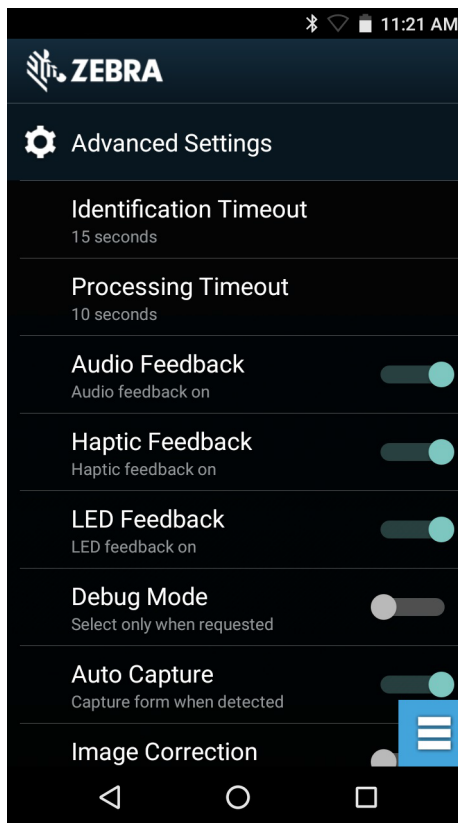

Figure 3-28 *Advanced Settings Screen*

- **Identification Timeout** - Set the amount of time to wait before timing out identifying the target document. Options: **2 seconds**, **5 seconds**, **10 seconds**, **15 seconds**, **20 seconds** or **25 seconds**.
- **Processing Timeout** - Once the target document is identified, amount of time to wait before timing out processing.
- **Audio Feedback** - Turn on or off audio feedback on successful parse.
- **Haptic Feedback** - Turn on or off haptic (vibration) feedback on successful parse.
- **LED Feedback** - Turn on or off LED feedback on successful parse.
- **Debug Mode** - If enabled, allows a session to write form capture, region images, region values, and other data to storage. Use only when directed by administrator.
- **Auto Capture** - Set to **On** to automatically capture forms when detected. Set to **Off** to manually capture forms when user taps screen or presses a trigger button.
- **Image Correction** - Turn on when document is crumpled or curved and requires advanced image correction.
- **Capture Sensitivity** - Increase sensitivity for increased document identification accuracy before processing.
- **About** - Displays the SimulScan Engine version number.
- **Quit Scanner** - Exit Advanced Settings screen.

Demo Customization

Before creating a customized demo, first:

- Create a template using the Template Builder tool.
- Copy a company logo and image to the device storage location.

1. Touch **Menu** icon.
2. Touch **Setup Custom Demo**.

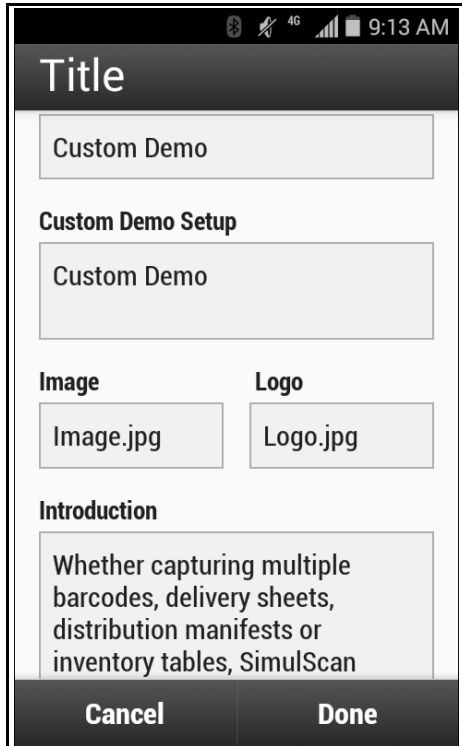

Figure 3-29 Custom Demo Setup Screen

3. In the **Name** text box, enter a name for the custom demo. This name appears in the drop-down menu.
4. In the **Custom Demo Setup** text box, enter a title for the demo. This appears in the demo screen title box.
5. Touch the **Image** field to select an image from the SD card.
6. Touch the **Logo** field to select the logo image from the SD card.
7. In the **Introduction** text box, enter text that will appear on the demo screen.
8. In the **Header color** text box, enter the hex color value for the header.
9. In the **Icon color** text box, enter the hex color value for Menu icon and button text.
10. In the **Key Features** text box, enter text that will appear under the Key Feature heading. This text appears in bullet format.
11. Touch one of the **SimulScan Document Capture Template** fields to select a template
 - a. **Browse external storage** - select a template loaded on the device.
 - b. **Default templates** - select one of the default templates.
 - c. **Select from server** - select a template from the SimulScan server.
12. Touch **Done**. The customized example appears on the screen.
13. Touch **Start SimulScan** to begin the demonstration.

Default Templates

The following templates are available:

- **Default - BankCheck.xml** – Use this template to read the MICR E-13B font (length between 19 and 40 characters) on bank checks.

- **Default - Barcode 1.xml** – Use this template to read a single supported bar code.
- **Default - Barcode 10.xml** – Use this template to read up to 10 supported bar codes.
- **Default - Barcode 2.xml** – Use this template to read two supported bar codes.
- **Default - Barcode 4.xml** – Use this template to read up to supported four bar codes.
- **Default - Barcode 5.xml** – Use this template to read up to supported five bar codes.
- **Default - BookNumber.xml** – Use this template to read the OCR-B ISBN 10 or 13 digit book numbers.
- **Default - DocCap + Optional Barcode** – Use this template to capture a full page image and decode any supported bar codes that are in the form. The captured area is the largest rectangular region in the field of view defined by the solid border or contrast of background. Any OCR or OMR content will not be decoded in this mode. The captured area is further processed to correct, de-skew and sharpen and returned as a picture.
- **Default - DocCap + Required Barcode** – Use this template to capture a full page image and decode of any supported bar codes that are present in the form. The captured area is the largest rectangular region in the field of view defined by the solid border or contrast of background. Any OCR or OMR content will not be decoded in this mode. The captured area is further processed to correct, de-skew and sharpen and returned as a picture.
- **Default - TravelDoc.xml** – Use this template to read passport and Visa travel documents with OCR-B types A and B fonts.
- **Default - Unstructured Multi-Line** – Use this template to read up to seven lines of text.
- **Default - Unstructured Single Line** – Use this template to read a single line of text.

Elemesz



NOTE Elemesz collects specific device information in the background and sends this information to us to help improve product functionality. This feature can be disabled. See *Disabling Elemesz Data Collection on page 3-40*.

Use **Elemesz** to provide diagnostics information to Zebra. Touch **Submit Diagnostics** button to send the data.

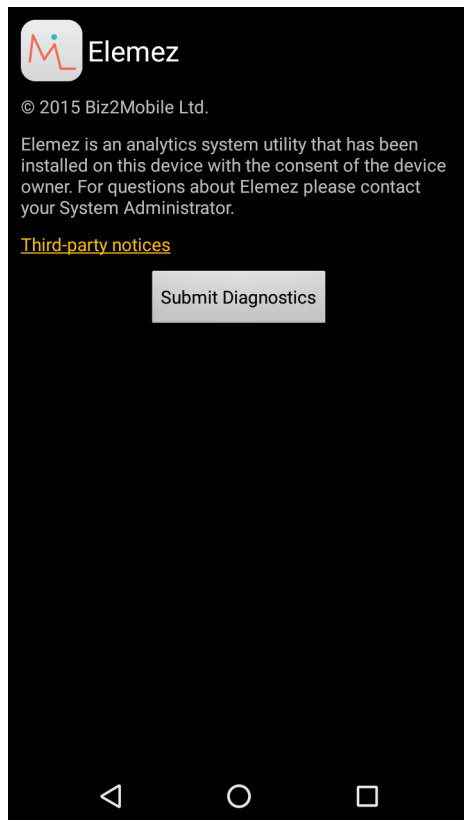



Figure 3-30 *Elemesz Application*

Disabling Elemesz Data Collection





The user can disable the **Elemesz** application from collection specific data in the background and send it to Zebra Technologies.

1. From the Home screen, touch .
2. Touch **Apps**.
3. Scroll through the list and touch **Elemesz**.
4. Touch **FORCE STOP**.
5. Touch **OK**.
6. Touch **DISABLE**.
7. Touch **DISABLE APP**.
- 8.

9. Touch .

Enabling Elemez Data Collection

The user can re-enable the Elemez application for collection specific data in the background and sending it to Zebra Technologies.

1. From the Home screen, touch .
2. Touch **Apps**.
3. Scroll through the list and touch **Elemez**.
4. Touch **ENABLE**.
5. Touch .
6. Touch .
7. Touch .
8. Touch **Enable Elemez**.
9. Touch .

CHAPTER 4 DATA CAPTURE

The TC51 supports data capture using:

- integrated imager
- RS507 Hands-free imager
- RS6000 Bluetooth Ring Scanner
- DS3678 Digital Scanner

The RS6000 Ring Scanner and DS3678 Digital Scanner is available on builds BSP 16-04 and above.

Imaging

The TC51 with an integrated 2D imager has the following features:

- Omnidirectional reading of a variety of bar code symbologies, including the most popular linear, postal, PDF417, and 2D matrix code types.
- The ability to capture and download images to a host for a variety of imaging applications.
- Advanced intuitive laser aiming cross-hair and dot aiming for easy point-and-shoot operation.

The imager uses imaging technology to take a picture of a bar code, stores the resulting image in its memory, and executes state-of-the-art software decoding algorithms to extract the bar code data from the image.

Operational Modes

The TC51 with an integrated imager supports two modes of operation, listed below. Activate each mode by pressing the Scan button.

- **Decode Mode:** In this mode, the TC51 attempts to locate and decode enabled bar codes within its field of view. The imager remains in this mode as long as the user holds the scan button, or until it decodes a bar code.



NOTE To enable Pick List Mode, configure in DataWedge or set in an application using a API command.

- **Pick List Mode:** This mode allows the user to selectively decode a bar code when more than one bar code is in the TC51's field of view. To accomplish this, move the aiming crosshair or dot over the required bar code to

decode only this bar code. This feature is ideal for pick lists containing multiple bar codes and manufacturing or transport labels containing more than one bar code type (either 1D or 2D).

RS507 Hands-Free Imager

The RS507 Hands-free Imager is a wearable bar code scan solution for both 1D and 2D bar code symbologies. The scanner supports Bluetooth Human Interface Device (HID) connection to the device.

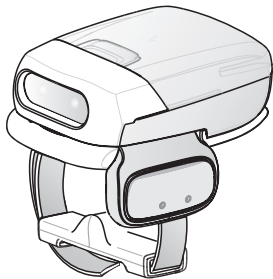

Figure 4-1 *RS507 Hands-Free Imager*

Refer to the *RS507 Hands-free Imager Product Reference Guide* for more information.

RS6000 Bluetooth Ring Scanner

The RS6000 Bluetooth Ring Scanner is a wearable bar code scan solution for both 1D and 2D bar code symbologies.

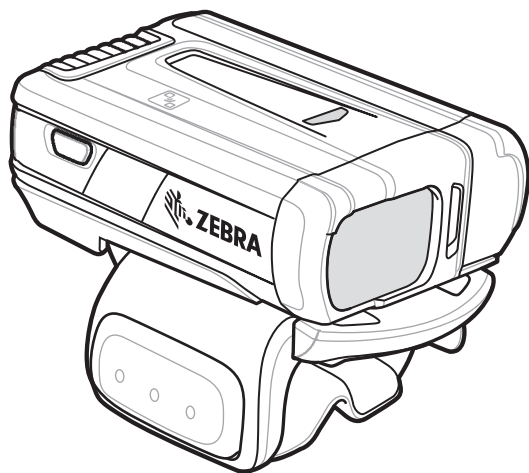

Figure 4-2 *RS6000 Bluetooth Ring Scanner*

Refer to the *RS6000 Bluetooth Ring Scanner Product Reference Guide* for more information.

DS3678 Digital Scanner

The cordless DS3678 combines superior 1D and 2D omnidirectional bar code scanning performance and advanced ergonomics in a lightweight design.

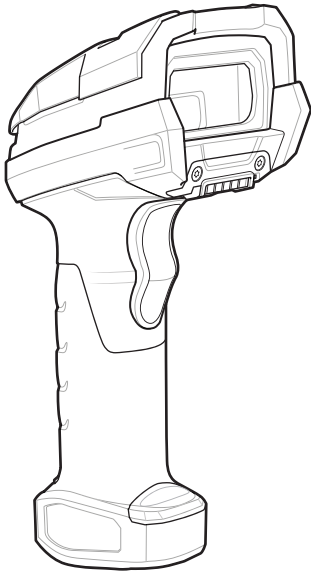

Figure 4-3 DS3678 Digital Scanner

Refer to the *DS36X8 Digital Scanner Product Reference Guide* for more information.

Scanning Considerations

Typically, scanning is a simple matter of aim, scan, and decode and a few quick trial efforts master it. However, consider the following to optimize scanning performance:

- *Range*: Any scanning device decodes well over a particular working range — minimum and maximum distances from the bar code. This range varies according to bar code density and scanning device optics. Scanning within range brings quick and constant decodes; scanning too close or too far away prevents decodes. Move the scanner closer and further away to find the right working range for the bar codes being scanned.
- *Angle*: Scanning angle is important for promoting quick decodes. When laser beams reflect directly back into the scanner from the bar code, this specular reflection can “blind” the scanner. To avoid this, scan the bar code so that the beam does not bounce directly back. But don’t scan at too sharp an angle; the scanner needs to collect scattered reflections from the scan to make a successful decode. Practice quickly shows what tolerances to work within.
- Hold the TC51 farther away for larger symbols
- Move the TC51 closer for symbols with bars that are close together.



NOTE Scanning procedures depend on the application and TC51 configuration. An application may use different scanning procedures from the one listed above.

Bar Code Scanning with Internal Imager

To read a bar code, a scan-enabled application is required. The TC51 contains the DataWedge application that allows the user to enable the imager, decode the bar code data and display the bar code content.

1. Ensure that an application is open on the TC51 and a text field is in focus (text cursor in text field).

2. Point the exit window on the top of the TC51 at a bar code.

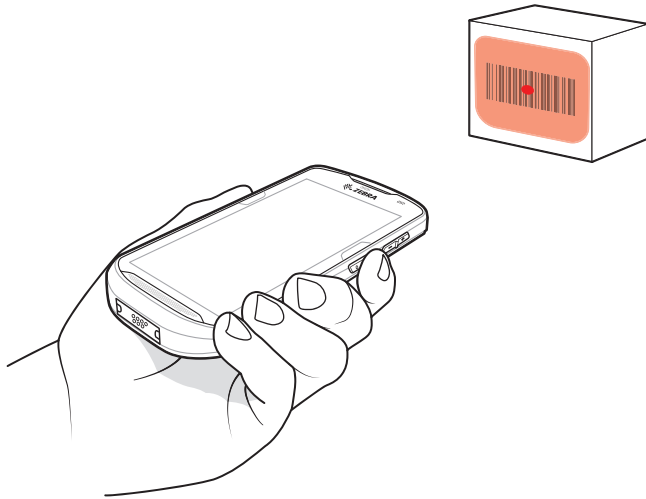

Figure 4-4 *Imager Scanning*

3. Press and hold the scan button.
The red LED aiming pattern turns on to assist in aiming.

✓ **NOTE** When the TC51 is in Picklist mode, the imager does not decode the bar code until the crosshair or aiming dot touches the bar code.

4. Ensure the bar code is within the area formed by the crosshairs in the aiming pattern. The aiming dot is used for increased visibility in bright lighting conditions.

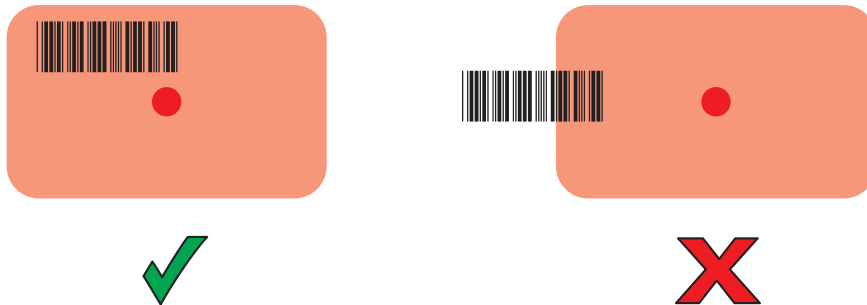

Figure 4-5 *Aiming Pattern*

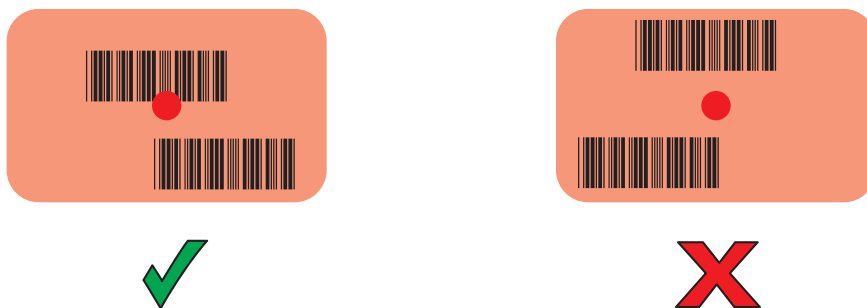

Figure 4-6 *Pick List Mode with Multiple Bar Codes in Aiming Pattern*

5. The Data Capture LED lights green and a beep sounds, by default, to indicate the bar code was decoded successfully.
6. Release the scan button.

✓ **NOTE** Imager decoding usually occurs instantaneously. The TC51 repeats the steps required to take a digital picture (image) of a poor or difficult bar code as long as the scan button remains pressed.

7. The bar code content data displays in the text field.

Bar Code Capture with RS6000 Bluetooth Ring Scanner

To read a bar code, a scan-enabled application is required. The TC51 contains the **DataWedge** application that allows the user to enable the scanner to decode bar code data and display the bar code content. See *DataWedge Demonstration on page 3-22* for more information on launching DataWedge.

Pair the RS6000 with the TC51. See *Pairing Using Simple Serial Interface on page 4-11* or *Pairing Using Bluetooth Human Interface Device on page 4-11* for more information.

1. Ensure that an application is open on the device and a text field is in focus (text cursor in text field).
2. Point the RS6000 at a bar code.

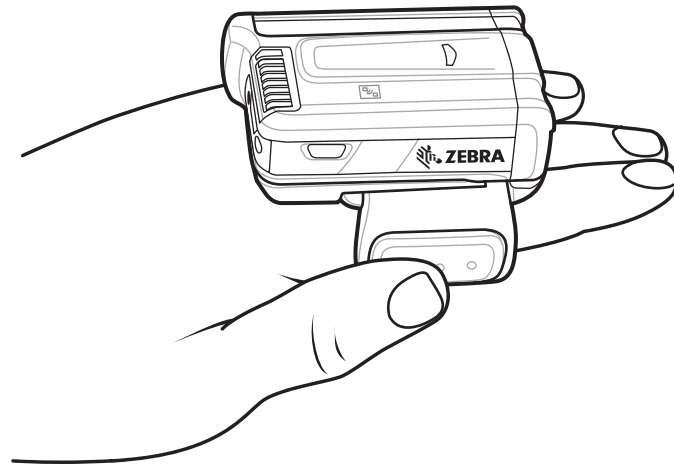

Figure 4-7 Bar Code Scanning with RS6000

3. Press and hold the trigger.

The red laser aiming pattern turns on to assist in aiming. Ensure the bar code is within the area formed by the cross-hairs in the aiming pattern. The aiming dot is used for increased visibility in bright lighting conditions.

The RS6000 LEDs light green, a beep sounds to indicate the bar code was decoded successfully. Note that when the RS6000 is in Pick List Mode, the RS6000 does not decode the bar code until the center of the crosshair touches the bar code.

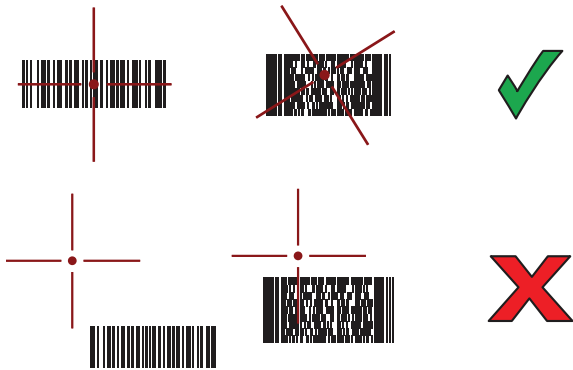

Figure 4-8 Aiming Pattern



Figure 4-9 Pick List Mode with Multiple Bar Codes in Aiming Pattern

4. The captured data appears in the text field.

Bar Code Capture with RS507 Hands-Free Imager

Pair the RS507 with the TC51. See *Pairing Using Simple Serial Interface on page 4-11* or *Pairing Using Bluetooth Human Interface Device on page 4-11* for more information.

1. Ensure that an application is open on the device and a text field is in focus (text cursor in text field).
2. Point the RS507 at a bar code.

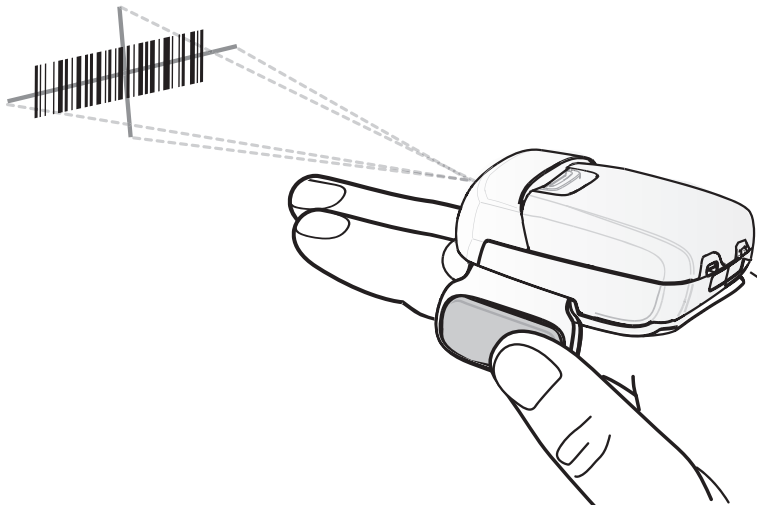

Figure 4-10 Bar Code Scanning with RS507

3. Press and hold the trigger.

The red laser aiming pattern turns on to assist in aiming. Ensure the bar code is within the area formed by the cross-hairs in the aiming pattern. The aiming dot is used for increased visibility in bright lighting conditions.

The RS507 LEDs light green, a beep sounds to indicate the bar code was decoded successfully. Note that when the RS507 is in Pick List Mode, the RS507 does not decode the bar code until the center of the crosshair touches the bar code.

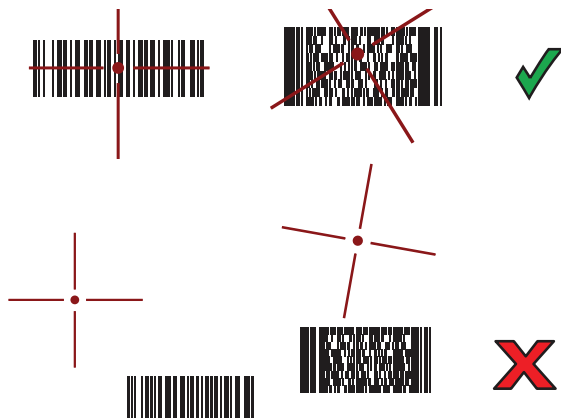

Figure 4-11 *Aiming Pattern*



Figure 4-12 *Pick List Mode with Multiple Bar Codes in Aiming Pattern*

4. The captured data appears in the text field.

Bar Code Capture with DS3678 Bluetooth Scanner

Pair the DS3678 with the TC51. See *Pairing the DS3678 Digital Scanner on page 4-12* for more information.

1. Ensure that an application is open on the device and a text field is in focus (text cursor in text field).
2. Point the DS3678 at a bar code.

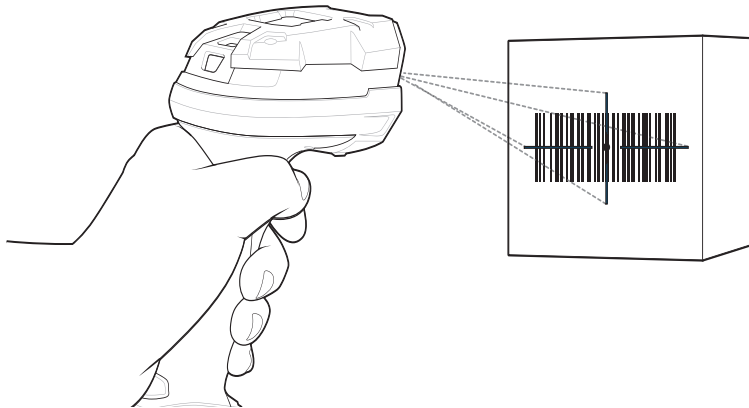

Figure 4-13 Bar Code Scanning with DS3678-HP

3. Press and hold the trigger.

Upon successful decode, the scanner beeps and the LED displays a single green flash.

Note that when the DS3678 is in Pick List Mode, the scanner does not decode the bar code until the center of the crosshair touches the bar code.



Figure 4-14 Aiming Pattern



Figure 4-15 Pick List Mode with Multiple Bar Codes in Aiming Pattern

4. The captured data appears in the text field.

Pairing the RS507/RS6000 Hands-Free Imager

To connect the RS507 or RS6000 imagers to the TC51, use one of the following methods:

- Near Field Communication (NFC) (RS6000 only)
- Simple Serial Interface (SSI)
- Bluetooth Human Interface Device (HID) Mode.

Pairing Using Near Field Communication

The TC51 provides the ability to pair the RS6000 using NFC.

✓ **NOTE** RS6000 only.

1. Ensure that the RS6000 is in SSI mode. Refer to the *RS6000 User Guide* for more information.
2. Ensure that NFC is enabled on the TC51.
3. Align the NFC icon on the RS6000 with the NFC icon on the TC51 battery.

The Status LED blinks blue indicating that the RS6000 is attempting to establish connection with the TC51. When connection is established, the Status LED turns off and the RS6000 emits a single string of low/high beeps.

A notification appears on the TC51 screen.

The  icon appears in the Status bar.

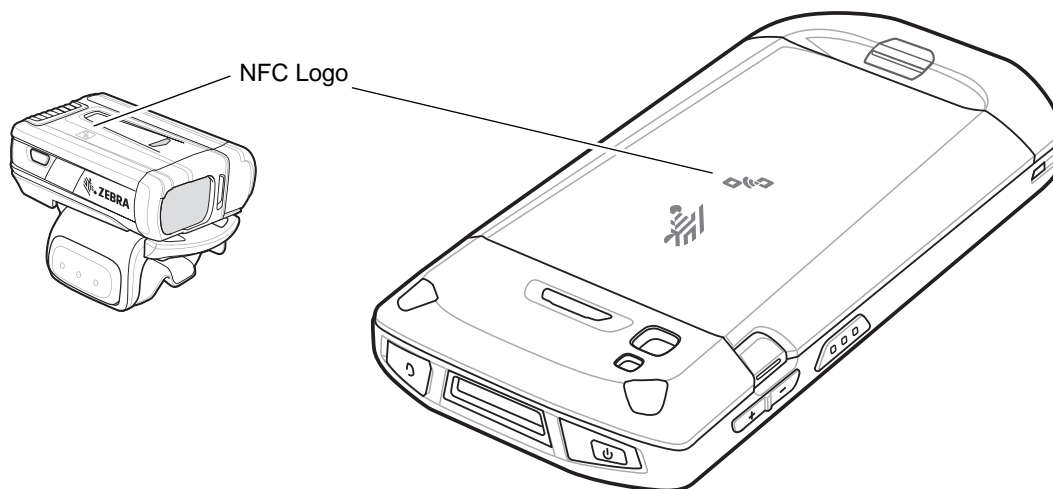



Figure 4-16 Align NFC Antennas

The TC51 pairs with the RS6000 and  appears in the Status bar.

✓ **NOTE** Not all Zebra device support NFC readers and the Tap-to-Pair feature.

Pairing in HID Mode Using Near Field Communication

The TC51 provides the ability to pair the RS6000 in HID Mode using NFC.

✓ **NOTE** RS6000 only.

1. Ensure that NFC is enabled on the TC51.
2. Ensure that Bluetooth is enabled on both devices.
3. Ensure that the Bluetooth device to discover is in discoverable mode.
4. Ensure that the two devices are within 10 meters (32.8 feet) of one another.
5. Place the RS6000 in Human Interface Device (HID) mode. If the RS6000 is already in HID mode, skip to step 5.
 - a. Remove the battery from the RS6000.
 - b. Press and hold the Restore key.
 - c. Install the battery onto the RS6000.
 - d. Keep holding the Restore key for about five seconds until a chirp is heard and the Scan LEDs flash green.
 - e. Scan the bar code below to place the RS6000 in HID mode.



Figure 4-17 Bluetooth HID Bar Code

6. Remove the battery from the RS6000.
7. Re-install the battery into the RS6000.
8. Align the NFC icon on the RS6000 with the NFC icon on the TC51.

The Status LED blinks blue indicating that the RS6000 is attempting to establish connection with the TC51. When connection is established, the Status LED turns off and the RS6000 emits a single string of low/high beeps.

A notification appears on the TC51 screen.

The  icon appears in the Status bar.

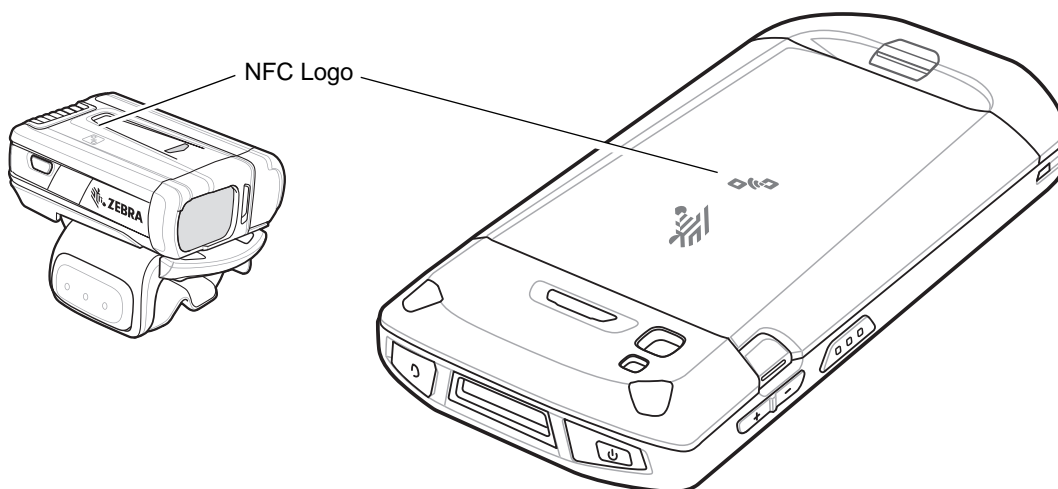



Figure 4-18 Align NFC Antennas

The TC51 pairs with the RS6000 and **A** appears in the Status bar.

✓ **NOTE** Not all Zebra device support NFC readers and the Tap-to-Pair feature.

Pairing Using Simple Serial Interface

To pair the RS507/RS6000 with the TC51 using SSI:

1. Ensure that the two devices are within 10 meters (32.8 feet) of one another.
2. Install the battery into the RS507/RS6000.
3. On the TC51 touch  > .

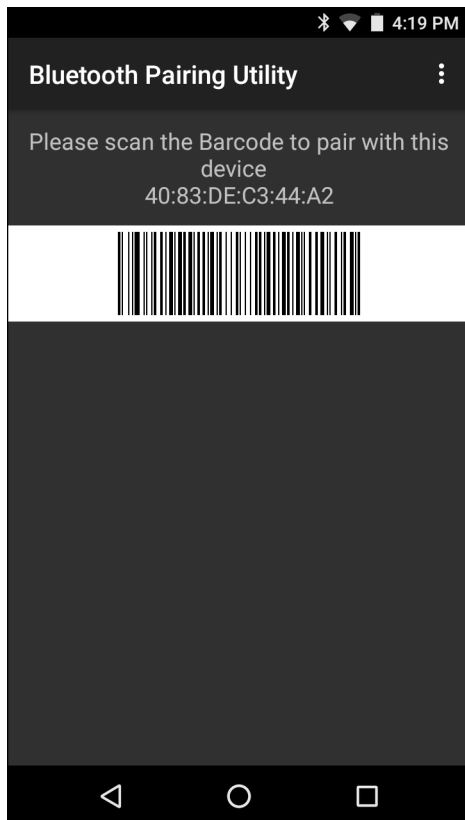



Figure 4-19 *Bluetooth Pairing Utility*

4. Using the RS507/RS6000, scan the bar code on the screen.
The RS507/RS6000 emits a high/low/high/low beeps. The Scan LED flashes green indicating that the RS507/RS6000 is attempting to establish connection with the TC51. When connection is established, the Scan LED turns off and the RS507/RS6000 emits one string of low/high beeps.
5. On the TC51 touch .



Pairing Using Bluetooth Human Interface Device

To pair the RS507/RS6000 with the TC51 using HID:

1. Ensure that Bluetooth is enabled on both devices.
2. Ensure that the Bluetooth device to discover is in discoverable mode.
3. Ensure that the two devices are within 10 meters (32.8 feet) of one another.
4. Place the RS507/RS6000 in Human Interface Device (HID) mode. If the RS507/RS6000 is already in HID mode, skip to step 5.
 - a. Remove the battery from the RS507/RS6000.
 - b. Press and hold the Restore key.
 - c. Install the battery onto the RS507/RS6000.
 - d. Keep holding the Restore key for about five seconds until a chirp is heard and the Scan LEDs flash green.
 - e. Scan the bar code below to place the RS507/RS6000 in HID mode.



Figure 4-20 *Bluetooth HID Bar Code*

5. Remove the battery from the RS507/RS6000.
6. Re-install the battery into the RS507/RS6000.
7. Swipe down with two fingers from the status bar to open the quick access panel and then touch .
8. Touch  **Bluetooth**.
9. Touch **SCAN FOR DEVICES**. The device begins searching for discoverable Bluetooth devices in the area and displays them under **AVAILABLE DEVICES**.
10. Scroll through the list and select RS507/RS6000.

The device connects to the RS507/RS6000 and **Connected** appears below the device name. The Bluetooth device is added to the **Bluetooth devices** list and a trusted (“paired”) connection is established.

Pairing the DS3678 Digital Scanner

To connect the DS3678 Digital Scanner to the TC51 using Bluetooth Human Interface Device (HID) Mode.

Pairing Using Simple Serial Interface

To pair the DS3678 with the TC51 using SSI:



1. Ensure that the two devices are within 10 meters (32.8 feet) of one another.
2. Install the battery into the DS3678.
3. On the TC51 touch  > .



Figure 4-21 *Bluetooth Pairing Utility*

4. Using the DS3678, scan the bar code on the screen.

The DS3678 emits a high/low/high/low beeps. The Scan LED flashes green indicating that the DS3678 is attempting to establish connection with the TC51. When connection is established, the Scan LED turns off and the DS3678 emits one string of low/high beeps.

5. On the TC51 touch .

Pairing Using Bluetooth Human Interface Device

To pair the DS3678 with the TC51 using HID:

1. Remove the battery from the DS3678 scanner.
2. Replace the battery.
3. After the DS3678 reboots, scan the bar code below to place the DS3678 in HID mode.

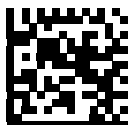



Figure 4-22 *HID Bluetooth Classic Bar Code*

4. On the TC51, swipe down with two fingers from the status bar to open the quick access panel and then touch



5. Touch  **Bluetooth**.
6. Touch **SCAN FOR DEVICES**. The device begins searching for discoverable Bluetooth devices in the area and displays them under **Available devices**.
7. Scroll through the list and select DS3678 xxxxxx, where xxxxxx is the serial number.





The device connects to the DS3678, the DS3678 beeps once and **Connected** appears below the device name. The Bluetooth device is added to the **Bluetooth devices** list and a trusted (“paired”) connection is established.

DataWedge





DataWedge is a utility that adds advanced bar code scanning capability to any application without writing code. It runs in the background and handles the interface to built-in bar code scanners. The captured bar code data is converted to keystrokes and sent to the target application as if it was typed on the keypad.

To configure DataWedge refer to the *TC51 Touch Computer Integrator Guide for Android Version 6.0.1*.

Enabling DataWedge

1. Touch .
2. Touch .
3. Touch .
4. Touch **Settings**.
5. Touch the **DataWedge enabled** checkbox. A blue checkmark appears in the checkbox indicating that DataWedge is enabled.
6. Touch .

Disabling DataWedge

1. Touch .
2. Touch .
3. Touch .
4. Touch **Settings**.
5. Touch the **DataWedge enabled** checkbox. The blue checkmark disappears from the checkbox indicating that DataWedge is disabled.
6. Touch .

CHAPTER 5 WIRELESS

This section provides information on the wireless features:

- Wireless Local Area Network (WLAN)
- Bluetooth
- Near Field Communications (NFC).

Wireless Local Area Networks

Wireless local area networks (WLANs) allow the TC51 to communicate wirelessly inside a building. Before using the TC51 on a WLAN, the facility must be set up with the required hardware to run the WLAN (sometimes known as infrastructure). The infrastructure and the TC51 must both be properly configured to enable this communication.

Refer to the documentation provided with the infrastructure (access points (APs), access ports, switches, Radius servers, etc.) for instructions on how to set up the infrastructure.

Once the infrastructure is set up to enforce the chosen WLAN security scheme, use the **Wireless & networks** settings configure the TC51 to match the security scheme.

The TC51 supports the following WLAN security options:

- Open
- Wireless Equivalent Privacy (WEP).
- Wi-Fi Protected Access (WPA)/WPA2 Personal (PSK).
- Extensible Authentication Protocol (EAP).

The **Status** bar displays icons that indicate Wi-Fi network availability and Wi-Fi status. See Status Bar for more information.



NOTE Turn off Wi-Fi when not using it, to extend the life of the battery.

Scan and Connect to a Wi-Fi Network

1. Swipe down with two fingers from the status bar to open the quick access panel.

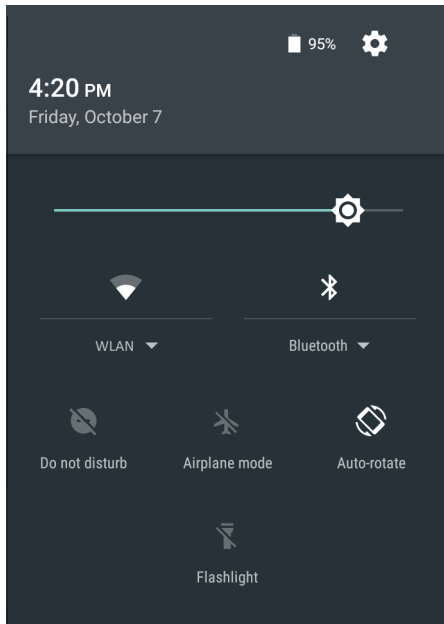

Figure 5-1 Quick Access Panel

2. Touch **WLAN** to open the **WLAN** screen. The TC51 searches for WLANs in the area and lists them.



Figure 5-2 WLAN Screen



3. Scroll through the list and select the desired WLAN network.
4. For open networks, touch profile once or press and hold and then select **Connect to network** or for secure networks enter the required password or other credentials then touch **Connect**. See the system administrator for more information.

The TC51 obtains a network address and other required information from the network using the dynamic host configuration protocol (DHCP) protocol. To configure the TC51 with a fixed internet protocol (IP) address, Refer to the *TC51 Touch Computer Integrator Guide for Android Version 6.0.1*.

5. In the Wi-Fi setting field, **Connected** appears indicating that the TC51 is connected to the WLAN.

Remove a Wi-Fi Network

To remove a remembered or connected network:

1. Swipe down with two fingers from the status bar to open the quick access panel and then touch .
2. Touch  **Wi-Fi**.
3. In the **Wi-Fi** list, touch and hold the name of the network.
4. In the menu, touch **Forget network**.
5. Touch .

Bluetooth

Bluetooth-equipped devices can communicate without wires, using frequency-hopping spread spectrum (FHSS) radio frequency (RF) to transmit and receive data in the 2.4 GHz Industry Scientific and Medical (ISM) band (802.15.1). Bluetooth wireless technology is specifically designed for short-range (10 meters (32.8 feet)) communication and low power consumption.

Devices with Bluetooth capabilities can exchange information (e.g., files, appointments, and tasks) with other Bluetooth enabled devices such as printers, access points, and other mobile devices.

The TC51 support Bluetooth Low Energy. Bluetooth Low Energy is targeted at applications in the healthcare, fitness, security, and home entertainment industries. It provides reduced power consumption and cost while maintaining standard Bluetooth range.

Adaptive Frequency Hopping

Adaptive Frequency Hopping (AFH) is a method of avoiding fixed frequency interferers, and can be used with Bluetooth voice. All devices in the piconet (Bluetooth network) must be AFH-capable in order for AFH to work. There is no AFH when connecting and discovering devices. Avoid making Bluetooth connections and discoveries during critical 802.11b communications. AFH for Bluetooth consists of four main sections:

- Channel Classification - A method of detecting an interference on a channel-by-channel basis, or pre-defined channel mask.
- Link Management - Coordinates and distributes the AFH information to the rest of the Bluetooth network.
- Hop Sequence Modification - Avoids interference by selectively reducing the number of hopping channels.
- Channel Maintenance - A method for periodically re-evaluating the channels.

When AFH is enabled, the Bluetooth radio “hops around” (instead of through) the 802.11b high-rate channels. AFH coexistence allows Enterprise devices to operate in any infrastructure.

The Bluetooth radio in this device operates as a Class 2 device power class. The maximum output power is 2.5 mW and the expected range is 10 meters (32.8 ft.). A definition of ranges based on power class is difficult to obtain due to power and device differences, and whether one measures open space or closed office space.



NOTE It is not recommended to perform Bluetooth wireless technology inquiry when high rate 802.11b operation is required.

Security

The current Bluetooth specification defines security at the link level. Application-level security is not specified. This allows application developers to define security mechanisms tailored to their specific need. Link-level security occurs between devices, not users, while application-level security can be implemented on a per-user basis. The Bluetooth specification defines security algorithms and procedures required to authenticate devices, and if needed, encrypt the data flowing on the link between the devices. Device authentication is a mandatory feature of Bluetooth while link encryption is optional.

Pairing of Bluetooth devices is accomplished by creating an initialization key used to authenticate the devices and create a link key for them. Entering a common personal identification number (PIN) in the devices being paired generates the initialization key. The PIN is never sent over the air. By default, the Bluetooth stack responds with no key when a key is requested (it is up to user to respond to the key request event). Authentication of Bluetooth devices is based-upon a challenge-response transaction. Bluetooth allows for a PIN or passkey used to create other 128-bit keys used for security and encryption. The encryption key is derived from the link key used to

authenticate the pairing devices. Also worthy of note is the limited range and fast frequency hopping of the Bluetooth radios that makes long-distance eavesdropping difficult.

Recommendations are:

- Perform pairing in a secure environment
- Keep PIN codes private and do not store the PIN codes in the device
- Implement application-level security.

Bluetooth Profiles

The device supports the following Bluetooth services:

- Service Discovery Protocol (SDP) - Handles the search for known and specific services as well as general services.
- Serial Port Profile (SPP) - Allows use of RFCOMM protocol to emulate serial cable connection between two Bluetooth peer devices. For example, connecting the device to a printer.
- Object Push Profile (OPP) - Allows the device to push and pull objects to and from a push server.
- Advanced Audio Distribution Profile (A2DP) - Allows the device to stream stereo-quality audio to a wireless headset or wireless stereo speakers.
- Audio/Video Remote Control Profile (AVRCP) - Allows the device to control A/V equipment to which a user has access. It may be used in concert with A2DP.
- Personal Area Network (PAN) - Allows the use of Bluetooth Network Encapsulation Protocol to provide L3 networking capabilities over a Bluetooth link. Only PANU role is supported.
- Human Interface Device Profile (HID) - Allows Bluetooth keyboards, pointing devices, gaming devices and remote monitoring devices to connect to the device.
- Headset Profile (HSP) - Allows a hands-free device, such as a Bluetooth headset, to place and receive calls on the device.
- Hands-Free Profile (HFP) - Allows car hands-free kits to communicate with the device in the car.
- Out of Band (OOB) - Allows exchange of information used in the pairing process. Pairing is completed using the Bluetooth radio, but requires information from the OOB mechanism. Using OOB with NFC enables pairing when devices simply get close, rather than requiring a lengthy discovery process.
- Phone Book Access Profile (PBAP) - Allows exchange of Phone Book Objects between a car kit and a mobile device to allow the car kit to display the name of the incoming caller; allow the car kit to download the phone book so the user can initiate a call from the car display.
- Symbol Serial Interface (SSI) - Allows for communication with RS507 Bluetooth Imager.

Bluetooth Power States

The Bluetooth radio is off by default.

- Suspend - When the TC51 goes into suspend mode, the Bluetooth radio stays on.
- Airplane Mode - When the TC51 is placed in Airplane Mode, the Bluetooth radio turns off. When Airplane mode is disabled, the Bluetooth radio returns to the prior state. When in Airplane Mode, the Bluetooth radio can be turned back on if desired.



Bluetooth Radio Power

Turn off the Bluetooth radio to save power or if entering an area with radio restrictions (e.g., an airplane). When the radio is off, other Bluetooth devices cannot see or connect to the device. Turn on the Bluetooth radio to exchange information with other Bluetooth devices (within range). Communicate only with Bluetooth radios in close proximity.





NOTE To achieve the best battery life turn off radios when not in use.

Enabling Bluetooth

1. Swipe down with two fingers from the status bar to open the quick access panel.
2. Touch  to turn Bluetooth on.
3. Touch .

Disabling Bluetooth

1. Swipe down with two fingers from the status bar to open the quick access panel.
2. Touch  to turn Bluetooth off.
3. Touch .



Discovering Bluetooth Device(s)



The TC51 can receive information from discovered devices without pairing. However, once paired, the TC51 and a paired device exchange information automatically when the Bluetooth radio is on. To find Bluetooth devices in the area:

1. Ensure that Bluetooth is enabled on both devices.
2. Ensure that the Bluetooth device to discover is in discoverable mode.
3. Ensure that the two devices are within 10 meters (32.8 feet) of one another.
4. Swipe down with two fingers from the status bar to open the quick access panel.
5. Touch **Bluetooth**.
6. Touch **More Settings**. The **Bluetooth** screen appears.
7. The TC51 begins searching for discoverable Bluetooth devices in the area and displays them under **Available devices**.
8. Scroll through the list and select a device. The **Bluetooth pairing request** dialog box appears.
9. Enter a PIN in the text box and touch **OK**. Enter the same PIN on the other device.
10. For Simple Pairing, touch **Pair** on both devices.
11. The Bluetooth device is added to the **Paired devices** list and a trusted (“paired”) connection is established.

Changing the Bluetooth Name

By default, the TC51 has a generic Bluetooth name that is visible to other devices when connected.

1. Swipe down with two fingers from the status bar to open the quick access panel and then touch .
2. Touch  **Bluetooth**.

3. If Bluetooth is not on, touch the switch to turn Bluetooth on.
4. Touch .
5. Touch **Rename device**.
6. Enter a name and touch **Rename**.
7. Touch .





Connecting to a Bluetooth Device

Once paired, connect to a Bluetooth device.

1. Swipe down with two fingers from the status bar to open the quick access panel and then touch .
2. Touch **Bluetooth**.
3. In the list, touch the unconnected Bluetooth device.
4. When connected, Connected appears below the device name.

Unpairing a Bluetooth Device

To unpair a Bluetooth device and erase all pairing information:

1. Touch  >  >  **Bluetooth**.
2. In the **Paired Devices** list, touch  next to the device name.
3. Touch **FORGET**.
4. Touch .

Near Field Communications

NFC/HF RFID is a short-range wireless connectivity technology standard that enables secure transaction between a reader and a contactless smartcard. The technology is based on ISO/IEC 14443 type A and B (proximity) and ISO/IEC 15693 (vicinity) standards, using the HF 13.56 MHz unlicensed band. The TC51 support 3 operating modes:

- Reader mode
- Peer-to-Peer communication
- Card Emulation mode.

Using NFC, the TC51 can:

- Read contactless cards such as contactless tickets, ID cards and ePassport.
- Read and write information to contactless cards such as SmartPosters and tickets, as well as devices with NFC interface such as vending machines.
- Read information from supported medical sensors.
- Pair with supported Bluetooth devices such as printers and headsets.
- Exchange data with another NFC device.
- Emulate contactless card such as payment, ticket or SmartPoster.

The TC51 NFC antenna is uniquely positioned to read NFC cards from the top of the device while being held in the user's hand.

Reading NFC Cards

1. Launch an NFC enabled application.
2. Hold device as shown.

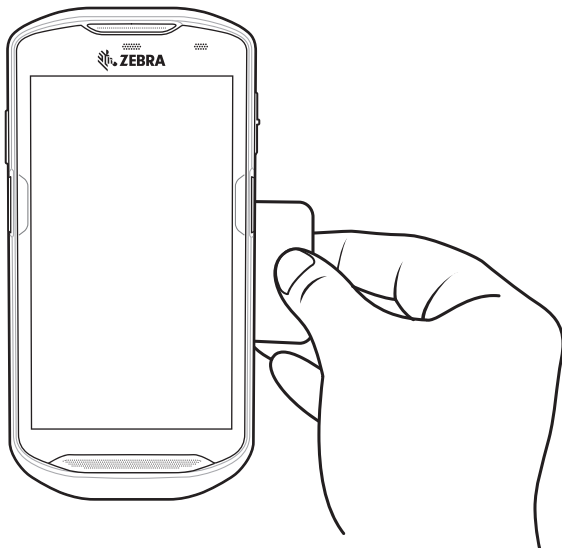

Figure 5-3 *Reading Cards*

3. Move TC51 close to the NFC card until the TC51 detects the card.
4. Hold the card steadily until the transaction is complete (usually indicated by the application).

Sharing Information Using NFC

You can beam content like a web page, contact cards, pictures, YouTube links or location information from your screen to another device by bringing the devices together back to back.

Make sure both devices are unlocked, support NFC, and have both NFC and Android Beam turned on.

1. Open a screen that contains a web page, video, photo or contact.
2. Move the back of the TC51 toward the back of the other device.

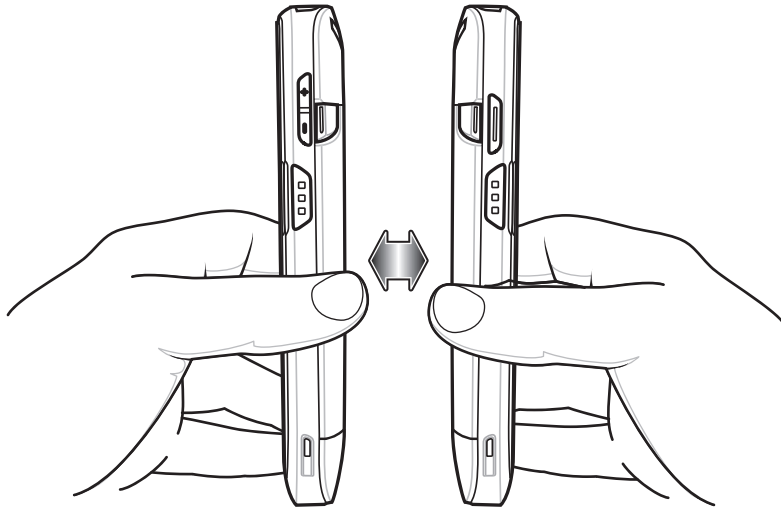

Figure 5-4 *Sharing Data Using NFC*

When the devices connect, you hear a sound, the image on the screen reduces in size, the message **Touch to beam** appears.

3. Touch anywhere on the screen.
The transfer begins.

CHAPTER 6 ACCESSORIES

This chapter provides information for using the accessories for the device.

Accessories

This table lists the accessories available for the TC51.

Table 6-1 *TC51 Accessories*

Accessory	Part Number	Description
Cradles		
1-Slot USB/Charge Only Cradle Kit	CRD-TC51-1SCU-01	Provides device charging and communication. Includes cradle, power supply (PWR-BGA12V50W0WW) and DC line cord.
4-Slot Charge Only Cradle with Battery Charger Kit	CRD-TC51-5SC4B-01	Charges up to four devices and four spare batteries. Includes cradle, power supply (PWR-BGA12V108W0WW) and DC line cord
5-Slot Charge Only Cradle Kit	CRD-TC51-5SCHG-01	Charges up to five devices. Includes, cradle, power supply (PWR-BGA12V108W0WW) and DC line cord.
5-Slot Ethernet Cradle Kit	CRD-TC51-5SETH-01	Provides device charging and provides Ethernet communication for up to five devices. Includes cradle, power supply (PWR-BGA12V108W0WW) and DC line cord.
Cradle Mount	BRKT-SCRD-SMRK-01	Mounts the 5-Slot Charge Only Cradle, 5-Slot Ethernet Cradle, and 4-Slot Battery Charger to a wall or rack.

Table 6-1 TC51 Accessories (Continued)

Accessory	Part Number	Description
Batteries and Chargers		
4,300 mAh (typical) / 4,050 mAh (minimum) PowerPrecisionPlusbattery	BTRY-TC51-43MA1-01	Replacement battery (single pack).
	BTRY-TC51-43MA1-10	Replacement battery (10-pack).
4-Slot Battery Charger Kit	SAC-TC51-4SCHG-01	Charges up to four battery packs. Includes cradle, power supply (PWR-BGA12V50W0WW) and DC line cord.
Vehicle Solutions		
Cigarette Light Adapter Auto Charge Cable	CHG-AUTO-USB1-01	Provides power to the device from a cigarette lighter socket.
Charge and Communication Cables		
Rugged Charge/USB Cable	CBL-TC51-USB1-01	Provides communication and power to the device. Requires power supply PWR-WUA5V12W0xx.
Audio Accessories		
2.5 mm Audio Adapter	CBL-TC51-HDST25-01	Plugs into the device and provides audio to a wired headset with 2.5 mm plug.
2.5 mm Headset	HDST-25MM-PTVP-01	Use for PTT and VoIP calls
3.5 mm Audio Adapter	CBL-TC51-HDST35-01	Plugs into the device and provides audio to a wired headset with collared 3.5 mm plug.
3.5 mm Headset	HDST-35MM-PTVP-01	Use for PTT and VoIP calls.
Miscellaneous		
Rugged Boot	SG-TC51-EXO1-01	Provides additional protection for the device.
Trigger Handle	TRG-TC51-SNP1-01	Adds gun-style handle with a scanner trigger for comfortable and productive scanning. Requires Rugged Boot.
Trigger Handle Kit (with Rugged Boot)	TRG-TC51-TRG1-01	Adds gun-style handle with a scanner trigger for comfortable and productive scanning.
Screen Protector	KT-TC51-SCRNP1-01	Add additional screen protection.
Carrying Solutions		
Soft Holster	SG-TC51-HLSTR1-01	Use to hold the device on hip. Accepts device with Rugged Boot and Trigger Handle
Hand Strap	SG-TC51-EHDSTP1-03	Replacement hand strap with hand strap mounting clip (3-pack).
Basic Hand Strap	SG-TC51-BHDSTP1-03	Provide a hand strap to assist in holding the TC51 without a Rugged Boot.

Table 6-1 TC51 Accessories (Continued)

Accessory	Part Number	Description
Stylus and Coiled Tether	SG-TC7X-STYLUS-03	TC51 stylus with coiled tether (3-pack).
Power Supplies		
Power Supply	PWR-BGA12V50W0WW	Provides power to the 1-Slot USB Charge cradle and 4-Slot Spare Battery Charger. Requires AC line cord.
Power Supply	PWR-BGA12V108W0WW	Provides power to the 4-Slot Charge Only Cradle with battery Charger, 5-Slot Charge Only cradle and the 5-Slot Ethernet Cradle. Requires DC Line Cord, p/n 50-16002-029R and country specific three wire grounded AC line cord sold separately.
Power Supply	PWR-WUA5V12W0US	Provides 12 VDC, 2.5 A power to the Rugged Charge/USB cable. Includes plug adapter for use in the United States.
Power Supply	PWR-WUA5V12W0GB	Provides 12 VDC, 2.5 A power to the Rugged Charge/USB cable. Includes plug adapter for use in the European Union.
Power Supply	PWR-WUA5V12W0EU	Provides 12 VDC, 2.5 A power to the Rugged Charge/USB cable. Includes plug adapter for use in the United Kingdom.
Power Supply	PWR-WUA5V12W0AU	Provides 12 VDC, 2.5 A power to the Rugged Charge/USB cable. Includes plug adapter for use in Australia.
Power Supply	PWR-WUA5V12W0CN	Provides 12 VDC, 2.5 A power to the Rugged Charge/USB cable. Includes plug adapter for use in China.
Power Supply	PWR-WUA5V12W0IN	Provides 12 VDC, 2.5 A power to the Rugged Charge/USB cable. Includes plug adapter for use in India.
DC Line Cord	CBL-DC-382A1-01	Provides power from the power supply (PWR-BGA12V108W0WW) to the 4-Slot Charge Only Cradle with Battery Charger, 5-Slot Charge Only Cradle and 5-Slot Ethernet Cradle.
DC Line Cord	CBL-DC-388A1-01	Provides power from the power supply (PWR-BGA12V50W0WW) to the 1-Slot USB/Charge Only Cradle and 4-Slot Battery Charger.

Table 6-1 *TC51 Accessories (Continued)*

Accessory	Part Number	Description
2-way DC Cable	CBL-DC-523A1-01	Connects one power supply (PWR-BGA12V108W0WW) to two 4-Slot Battery Chargers.
4-way DC Cable	CBL-DC-380A1-01	Connects one power supply (PWR-BGA12V108W0WW) to four 4-Slot Battery Chargers.

1-Slot USB Charge Cradle



CAUTION Ensure that you follow the guidelines for battery safety described in *Battery Safety Guidelines* on page 7-2.

The 1-Slot USB Charge Cradle:

- Provides 5 VDC power for operating the device.
- Charges the device's battery.
- Provides USB communication with host computer.

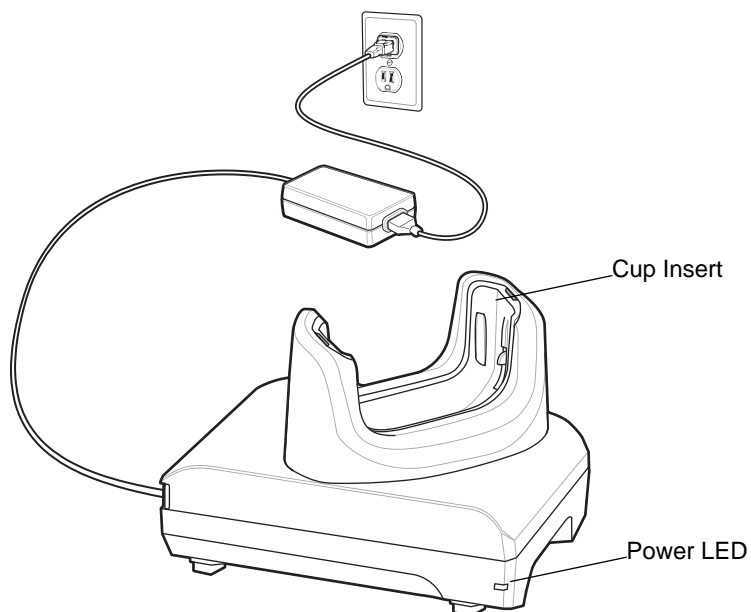

Figure 6-1 1-Slot USB Charge Cradle

Charging the Device

To charge a device:



NOTE If the device has a Rugged Boot, remove the cup insert before inserting the device. See *TC51 Touch Computer Integrator Guide for Android Version 6.0.1* for details.

By default, the device includes an interface connector. If the interface connector is removed for USB Type C cable connectivity, then it must be replaced before charging or receiving an Ethernet IP address if placed in a cradle.

1. Insert the device into the slot to begin charging.

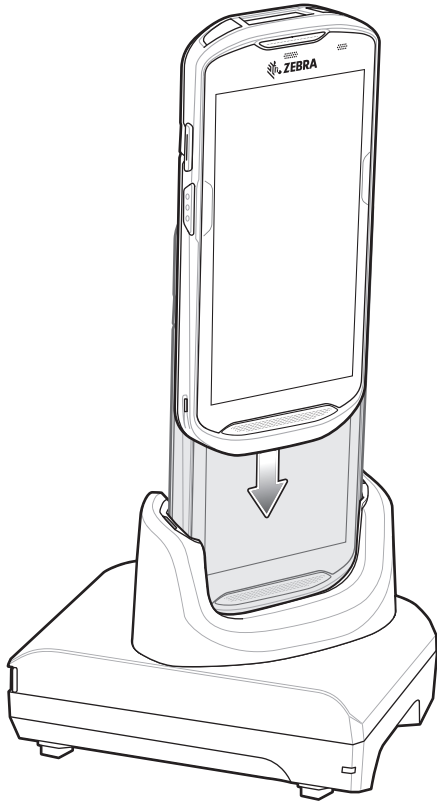

Figure 6-2 *Battery Charging*

2. Ensure the device is seated properly.

Inserting a TC51 with Rugged Boot into Cradle

Each cradle cup has an insert that must be removed prior to inserting the TC51 with Rugged Boot. Remove the insert and then insert the TC51 into the cup.

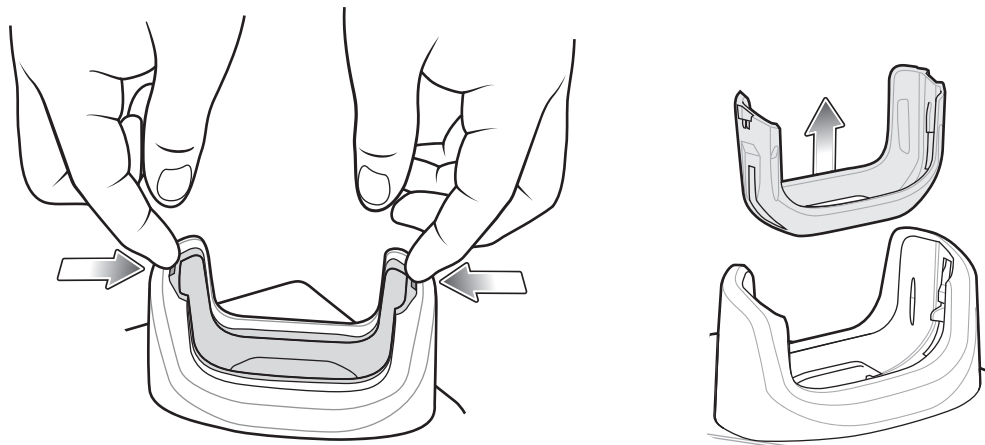

Figure 6-3 *Remove Insert from Cup*

Battery Charging

The device's Charging/Notification LED indicates the status of the battery charging in the device. See [Table 1-3 on page 1-8](#) for device charging status. The 4,300 mAh (typical) / 4,050 mAh (minimum) battery charges from fully depleted to 90% in approximately 2.5 hours and from fully depleted to 100% in approximately three hours.



NOTE In many cases the 90% charge provides plenty of charge for daily use. A full 100% charge lasts for approximately 14 hours of use.

To achieve the best fast charging results use only Zebra charging accessories and batteries. Charge batteries at room temperature with the TC51 in sleep mode.

Charging Temperature

Charge batteries in temperatures from 0°C to 40°C (32°F to 104°F). The device or cradle always performs battery charging in a safe and intelligent manner. At higher temperatures (e.g. approximately +37°C (+98°F)) the device or cradle may for small periods of time alternately enable and disable battery charging to keep the battery at acceptable temperatures. The device and cradle indicates when charging is disabled due to abnormal temperatures via its LED.

4-Slot Charge Only Cradle with Battery Charger



CAUTION Ensure that you follow the guidelines for battery safety described in *Battery Safety Guidelines* on page 7-2.

The 4-Slot Charge Only Cradle with Battery Charger:

- Provides 5 VDC power for operating the TC51.
- Simultaneously charges up to four TC51s and up to four spare batteries using the Battery Charger Adapter.

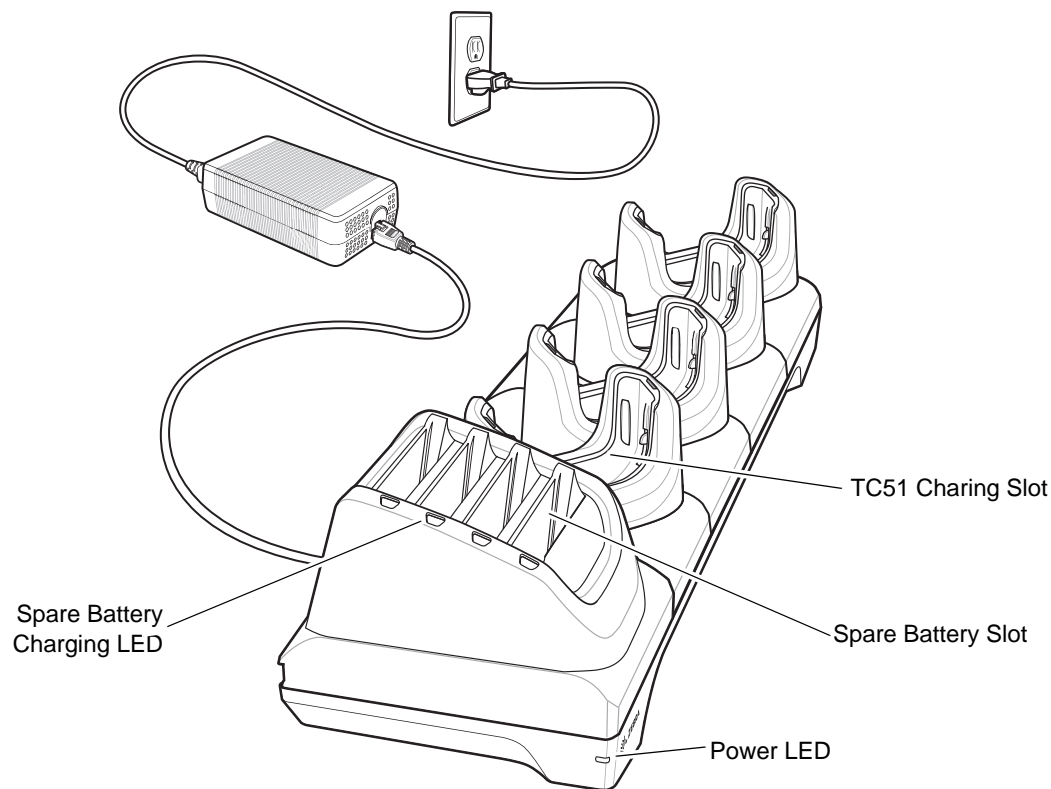

Figure 6-4 4-Slot Charge Only Cradle with Battery Charger

Charging the TC51

To charge a device:



NOTE If the device has a Rugged Boot, remove the cup insert before inserting the device. See *TC51 Touch Computer Integrator Guide for Android Version 6.0.1* for details.

1. Insert the TC51 into a slot to begin charging.

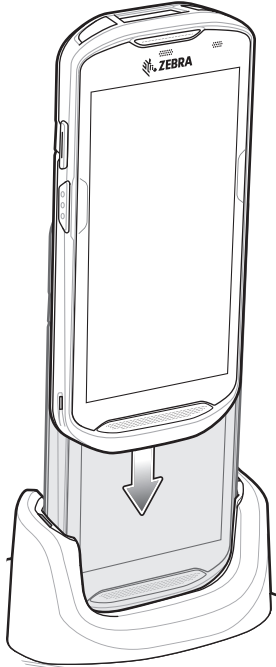

Figure 6-5 TC51 Battery Charging

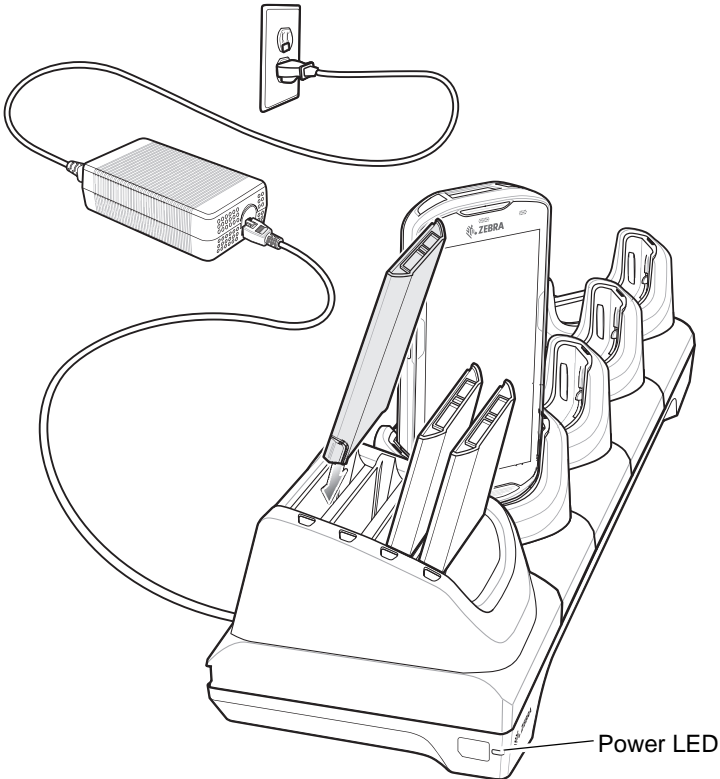

Figure 6-6 Spare Battery Charging

- 2. Ensure the TC51 is seated properly.



See the *TC51 Touch Computer Integrator Guide for Android Version 6.0.1* for information on installing the 4-Slot Battery Charger onto the cradle.

Inserting a TC51 with Rugged Boot into Cradle

Each cradle cup has an insert that must be removed prior to inserting the TC51 with Rugged Boot. Remove the insert and then insert the TC51 into the cup.

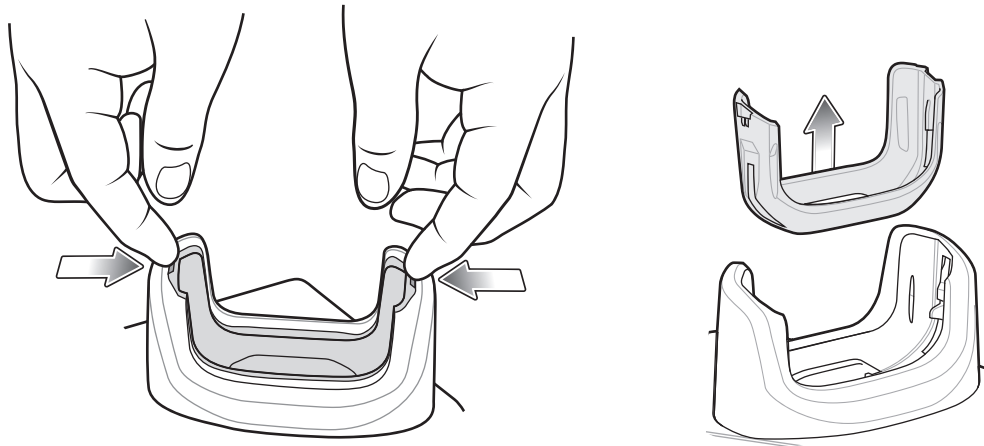

Figure 6-7 Remove Insert from Cup

Battery Charging

Main Battery Charging

The device's Charging/Notification LED indicates the status of the battery charging in the device. See [Table 1-3 on page 1-8](#) for device charging status. The 4,300 mAh (typical) / 4,050 mAh (minimum) battery charges from fully depleted to 90% in approximately 2.5 hours and from fully depleted to 100% in approximately three hours.



NOTE In many cases the 90% charge provides plenty of charge for daily use. A full 100% charge lasts for approximately 14 hours of use.

To achieve the best fast charging results use only Zebra charging accessories and batteries. Charge batteries at room temperature with the TC51 in sleep mode.

Spare Battery Charging







The Spare battery Charging LED on the cup indicates the status of the spare battery charging. The 4,300 mAh (typical) / 4,050 mAh (minimum) battery charges from fully depleted to 90% in approximately 2.3 hours and from fully depleted to 100% in approximately three hours.



NOTE In many cases the 90% charge provides plenty of charge for daily use. A full 100% charge lasts for approximately 14 hours of use.

To achieve the best fast charging results use only Zebra charging accessories and batteries.

Table 6-2 Spare Battery LED Charging Indicators

LED	LED	Indication
Solid amber		Spare battery is charging.
Solid amber with alternate bright amber		Best spare battery is charging.
Solid Green		Spare battery charging is complete.
Solid Green with alternate bright green		Best spare battery charging is complete.
Solid Red		Spare battery is charging and battery is at the end of useful life. Charging complete and battery is at the end of useful life.
Fast Blinking Red (2 blinks/second)		Error in charging; check placement of spare battery and battery is at the end of useful life.
Off		No spare battery in slot; spare battery not placed correctly; cradle is not powered.

Charging Temperature

Charge batteries in temperatures from 0°C to 40°C (32°F to 104°F). The device or cradle always performs battery charging in a safe and intelligent manner. At higher temperatures (e.g. approximately +37°C (+98°F)) the device or cradle may for small periods of time alternately enable and disable battery charging to keep the battery at acceptable temperatures. The device and cradle indicates when charging is disabled due to abnormal temperatures via its LED.

5-Slot Charge Only Cradle



CAUTION Ensure that you follow the guidelines for battery safety described in *Battery Safety Guidelines* on page 7-2.

The 5-Slot Charge Only Cradle:

- Provides 5 VDC power for operating the TC51.
- Simultaneously charges up to five TC51s.

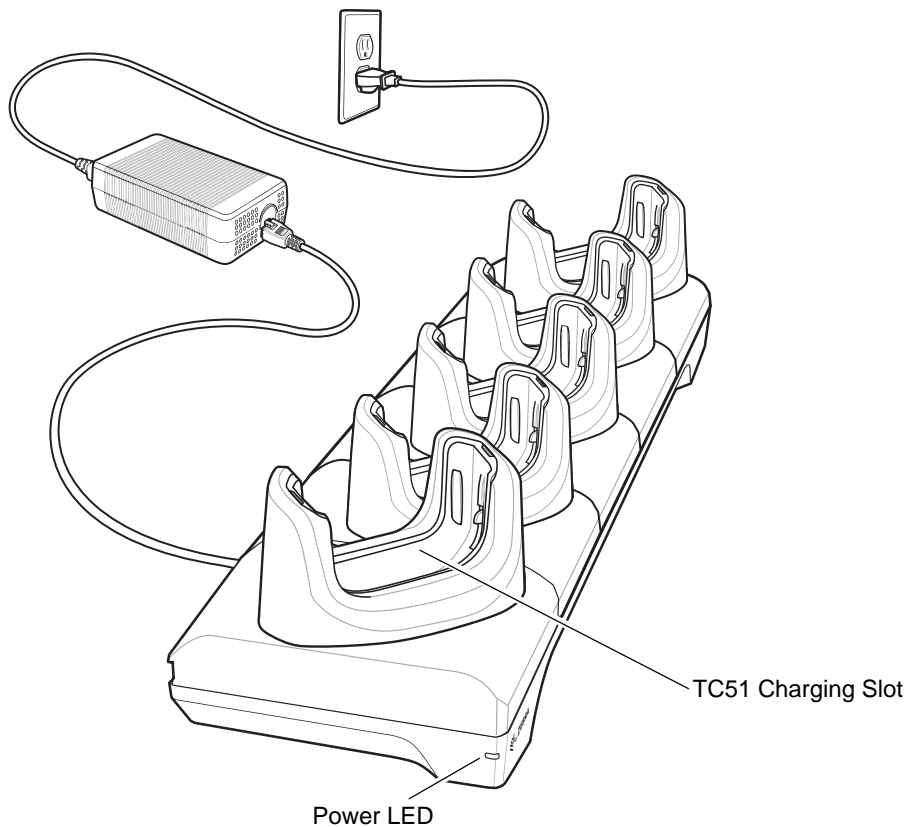

Figure 6-8 5-Slot Charge Only Cradle

Charging the TC51

To charge a device:



NOTE If the device has a Rugged Boot, remove the cup insert before inserting the device. See *TC51 Touch Computer Integrator Guide for Android Version 6.0.1* for details.

1. Insert the TC51 into a slot to begin charging.

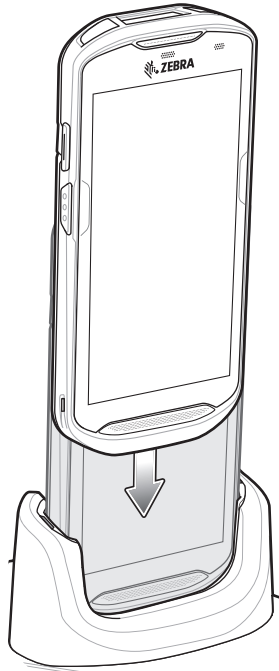

Figure 6-9 TC51 Battery Charging

2. Ensure the TC51 is seated properly.



See the *TC51 Touch Computer Integrator Guide for Android Version 6.0.1* for information on installing the 4-Slot Battery Charger onto the cradle.

Inserting a TC51 with Rugged Boot into Cradle

Each cradle cup has an insert that must be removed prior to inserting the TC51 with Rugged Boot. Remove the insert and then insert the TC51 into the cup.

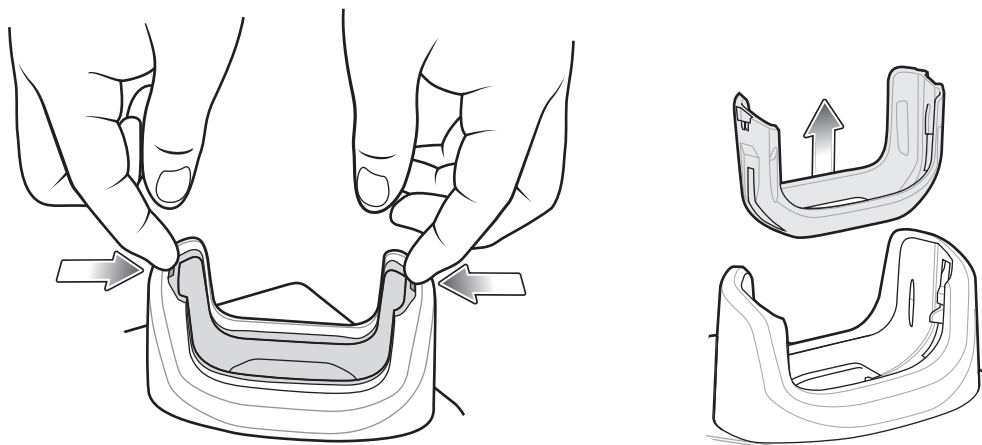

Figure 6-10 Remove Insert from Cup

Battery Charging

The device's Charging/Notification LED indicates the status of the battery charging in the device. See [Table 1-3 on page 1-8](#) for device charging status. The 4,300 mAh (typical) / 4,050 mAh (minimum) battery charges from fully depleted to 90% in approximately 2.5 hours and from fully depleted to 100% in approximately three hours.



NOTE In many cases the 90% charge provides plenty of charge for daily use. A full 100% charge lasts for approximately 14 hours of use.

To achieve the best fast charging results use only Zebra charging accessories and batteries. Charge batteries at room temperature with the TC51 in sleep mode.

Charging Temperature

Charge batteries in temperatures from 0°C to 40°C (32°F to 104°F). The device or cradle always performs battery charging in a safe and intelligent manner. At higher temperatures (e.g. approximately +37°C (+98°F)) the device or cradle may for small periods of time alternately enable and disable battery charging to keep the battery at acceptable temperatures. The device and cradle indicates when charging is disabled due to abnormal temperatures via its LED.

5-Slot Ethernet Cradle



CAUTION Ensure that you follow the guidelines for battery safety described in *Battery Safety Guidelines* on page 7-2.

The 5-Slot Ethernet Cradle:

- Provides 5 VDC power for operating the device.
- Connects the device (up to five) to an Ethernet network.
- Simultaneously charges up to five TC51s.

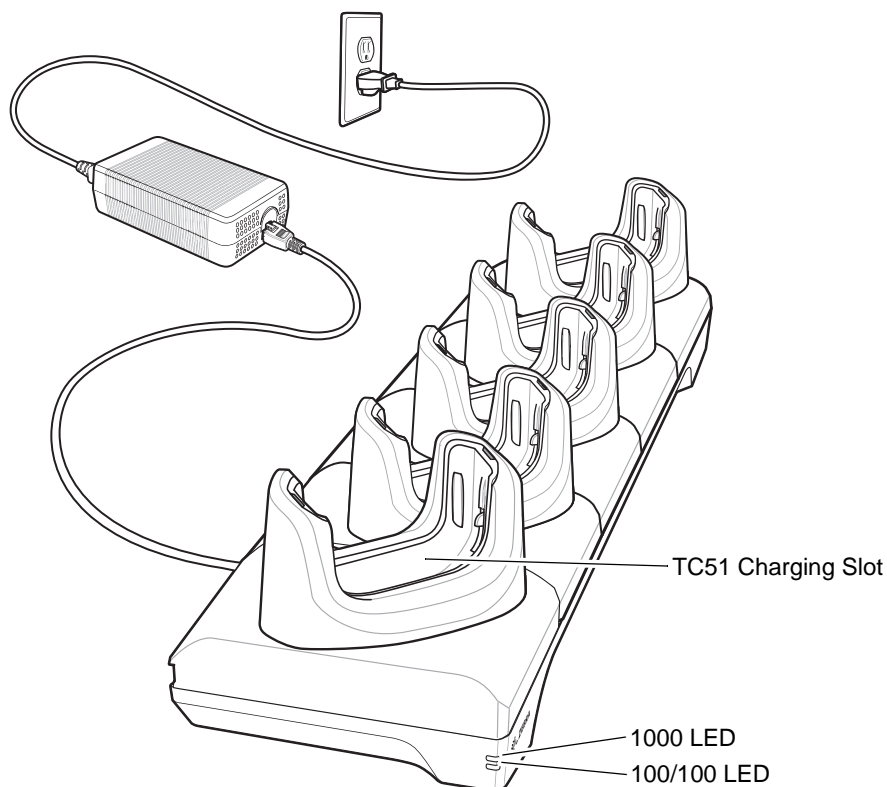

Figure 6-11 5-Slot Ethernet Cradle

Charging the TC51

To charge a device:



NOTE If the device has a Rugged Boot, remove the cup insert before inserting the device. See *TC51 Touch Computer Integrator Guide for Android Version 6.0.1* for details.

1. Insert the TC51 into a slot to begin charging.

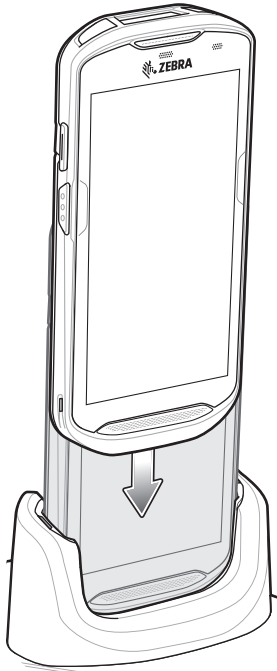

Figure 6-12 TC51 Battery Charging

2. Ensure the TC51 is seated properly.

Inserting a TC51 with Rugged Boot into Cradle

Each cradle cup has an insert that must be removed prior to inserting the TC51 with Rugged Boot. Remove the insert and then insert the TC51 into the cup.

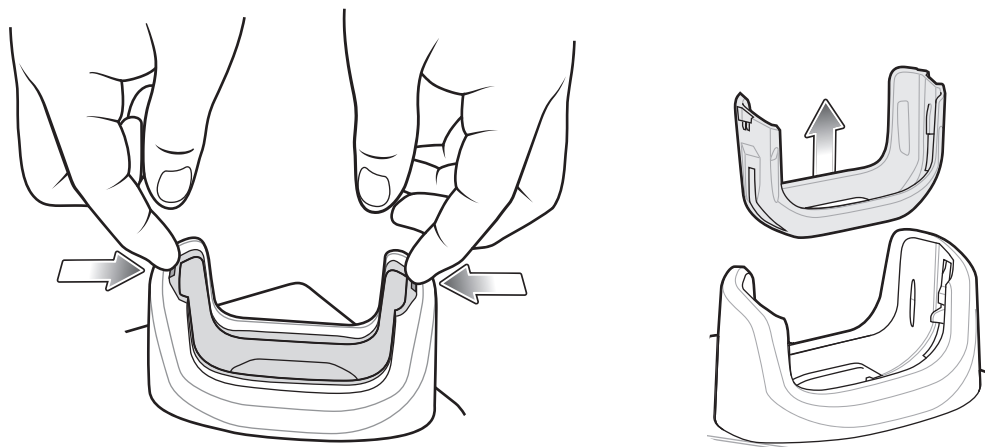

Figure 6-13 Remove Insert from Cup

Battery Charging

The device's Charging/Notification LED indicates the status of the battery charging in the device. See [Table 1-3 on page 1-8](#) for device charging status. The 4,300 mAh (typical) / 4,050 mAh (minimum) battery charges from fully depleted to 90% in approximately 2.5 hours and from fully depleted to 100% in approximately three hours.



NOTE In many cases the 90% charge provides plenty of charge for daily use. A full 100% charge lasts for approximately 14 hours of use.

To achieve the best fast charging results use only Zebra charging accessories and batteries. Charge batteries at room temperature with the TC51 in sleep mode.

Charging Temperature

Charge batteries in temperatures from 0°C to 40°C (32°F to 104°F). The device or cradle always performs battery charging in a safe and intelligent manner. At higher temperatures (e.g. approximately +37°C (+98°F)) the device or cradle may for small periods of time alternately enable and disable battery charging to keep the battery at acceptable temperatures. The device and cradle indicates when charging is disabled due to abnormal temperatures via its LED.

Establishing Ethernet Connection



NOTE Refer to the *TC51 Touch Computer Integrator Guide for Android Version 6.0.1* for information on configuring the Ethernet settings.

1. Swipe down with two fingers from the status bar to open the quick access panel and then touch .
2. Touch **Ethernet**.
3. Slide the Ethernet switch to the **ON** position.
4. Insert the device into a slot.

The  icon appears in the Status bar.

5. Touch **Eth0** to view Ethernet connection details.

LED Indicators

There are two green LEDs on the side of the cradle. These green LEDs light and blink to indicate the data transfer rate.

Table 6-3 LED Data Rate Indicators

Data Rate	1000 LED	100/10 LED
1 Gbps	On/Blink	Off
100 Mbps	Off	On/Blink
10 Mbps	Off	On/Blink

4-Slot Battery Charger



CAUTION Ensure that you follow the guidelines for battery safety described in *Battery Safety Guidelines* on page 7-2.

This section describes how to use the 4-Slot Battery Charger to charge up to four TC51 batteries.

Charging Spare Batteries

1. Connect the charger to a power source.
2. Insert the battery into a battery charging well and gently press down on the battery to ensure proper contact.

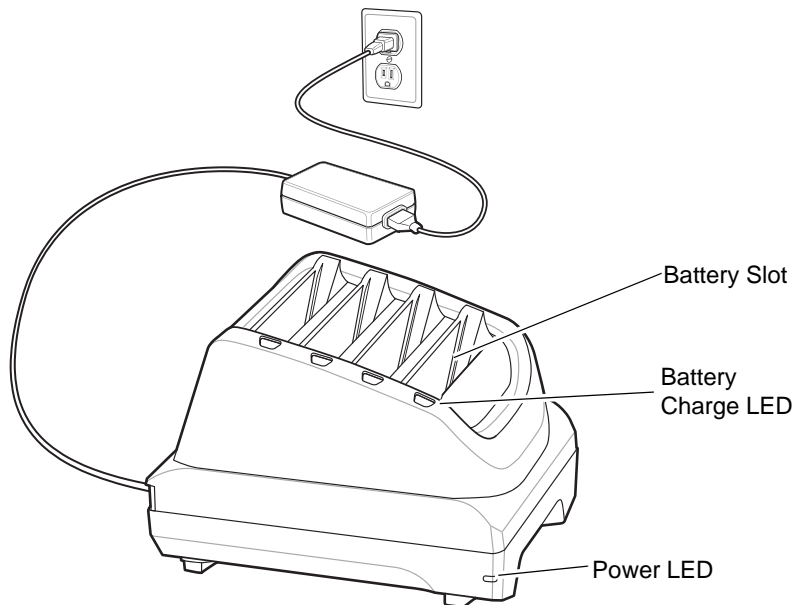

Figure 6-14 4-Slot Battery Charger

Battery Charging

Spare Battery Charging

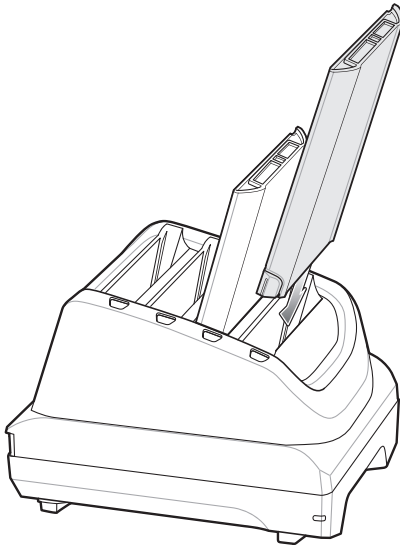

Figure 6-15 *Insert Battery into Charger*

Each Battery Charging LED indicates the status of the battery charging in each slot. See [Table 6-2 on page 6-11](#) for spare battery charging indicator descriptions.

The 4,300 mAh (typical) / 4,050 mAh (minimum) battery charges from fully depleted to 90% in approximately 2.3 hours and from fully depleted to 100% in approximately three hours.



NOTE In many cases the 90% charge provides plenty of charge for daily use. A full 100% charge lasts for approximately 14 hours of use.

To achieve the best fast charging results use only Zebra charging accessories and batteries.

Charging Temperature

Charge batteries in temperatures from 0°C to 40°C (32°F to 104°F). The battery charger always performs battery charging in a safe and intelligent manner. At higher temperatures (e.g. approximately +37°C (+98°F)) the battery charger may for small periods of time alternately enable and disable battery charging to keep the battery at acceptable temperatures. The battery charger indicates when charging is disabled due to abnormal temperatures via its LED.

Rugged Boot

The Rugged Boot provides additional protection for the device.

Installation

To install the Rugged Boot:

1. Insert the bottom of the device into the bottom of the boot.

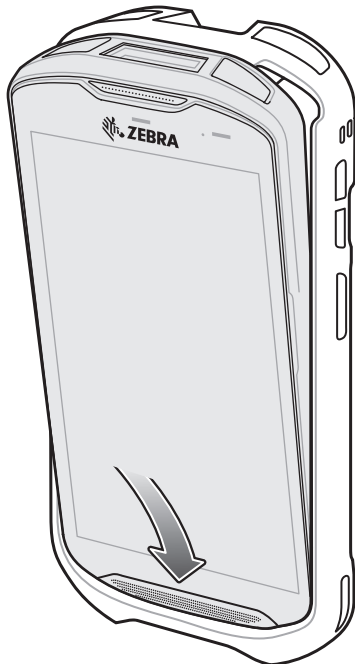

Figure 6-16 *Insert Device into Boot*

2. Lift the top of the Rugged Boot over the top of the device.



Figure 6-17 *Lift Boot Over Device*

3. Push the device into the Rugged Boot.

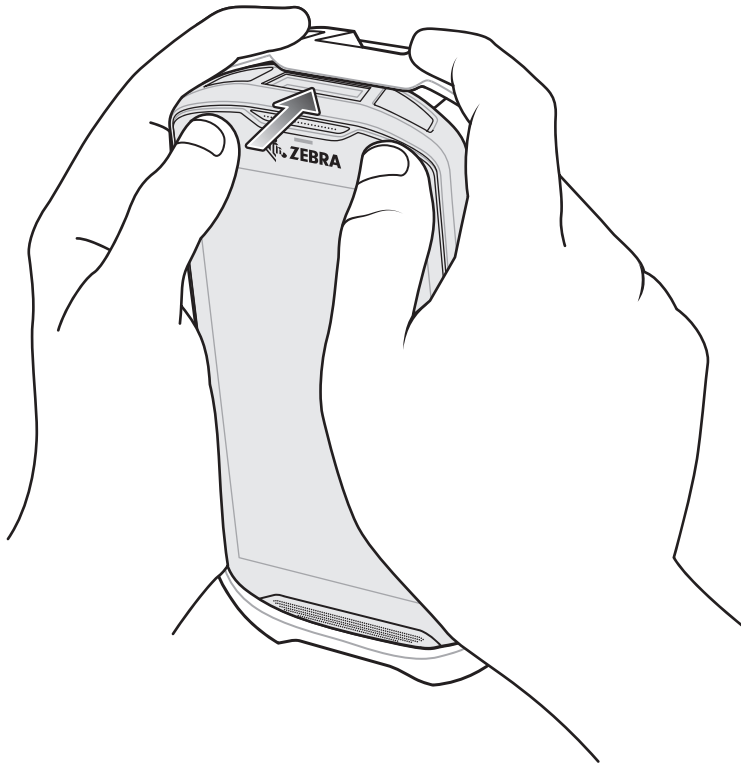

Figure 6-18 *Push Device into Boot*

Installing Stylus

To install the optional stylus:

1. Insert one of the loop ends of the tether through the hole in the stylus.
2. Feed the tether through the loop.
3. Pull the tether until the loop tightens.
4. Insert the loop into the hand strap holder.
5. Feed the stylus through the loop.

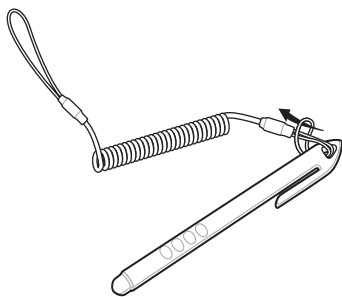

Figure 6-19 *Install Tether to Stylus*

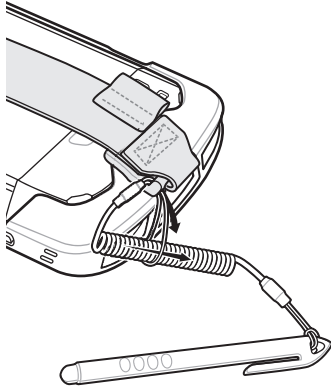

Figure 6-20 *Install Stylus on Hand Strap*

Charging with Cradles

Before inserting the device with the Rugged Boot into the cradle cup, remove the insert from the cup.

1. Using index fingers on both hands, push the insert toward the center of the cup.

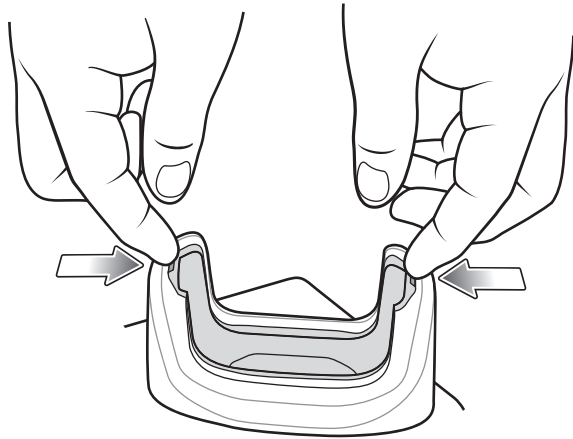

Figure 6-21 *Pull Insert Toward Center*

2. Lift insert out of cup.

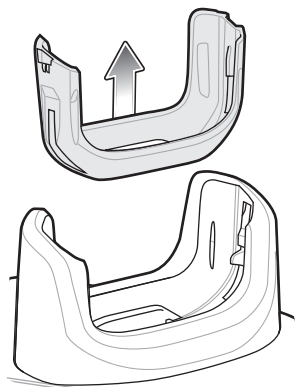

Figure 6-22 *Lift Insert Out of Cup*

3. Insert the device into the cradle.

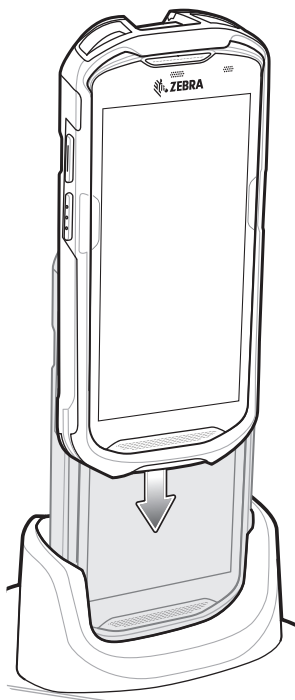

Figure 6-23 *Insert Device with Boot into Cradle Cup*

Basic Hand Strap Kit

Use to Basic Hand Strap Kit to add a hand strap to the device.

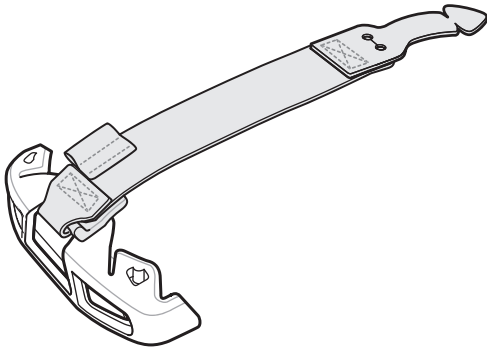

Figure 6-24 *Basic Hand Strap Kit*

Installation

To install the Basic Hand Strap Kit:

1. Remove the two rubber plugs on the back of the device.

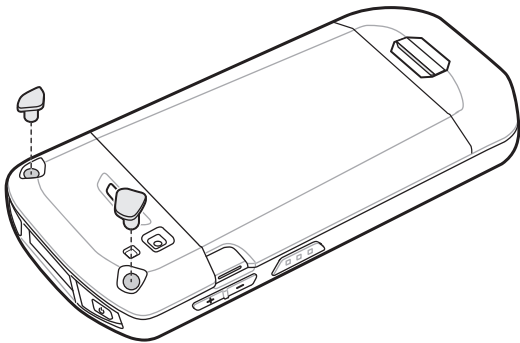

Figure 6-25 *Remove Plugs*

2. Align the top cap onto the device.
3. Rotate the top cap over the top of the device.

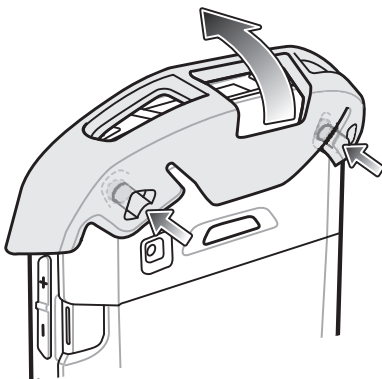

Figure 6-26 *Rotate Top Cap Cover Top of Device*

4. Insert the tab end of the hand strap into the slot on the device.

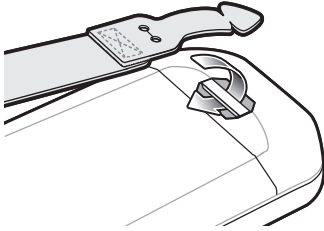

Figure 6-27 *Insert Hand Strap Tab into Slot*

5. Feed the tab into the cut in the strap.

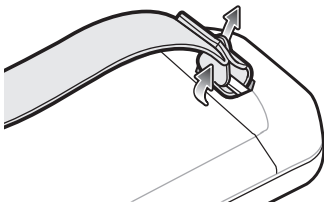

Figure 6-28 *Feed Tab into Slot*

6. Align the hand strap clip with the top cap.

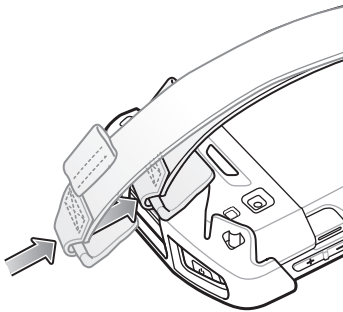

Figure 6-29 *Install Hand Strap Clip onto Top Cap*

7. Push the clip onto the top cap.

Removal

To remove the Basic Hand Strap Kit:

1. Using thumbs, push the top cap up and rotate over the top of the device.

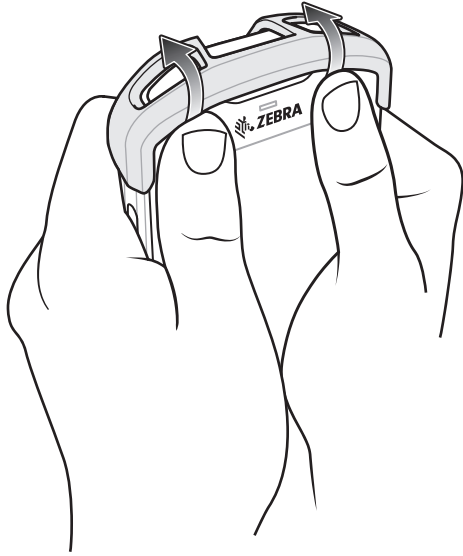

Figure 6-30 *Remove Top Cap*

2. Pull the strap tab through the cut slot.
3. Pull the Hand Strap tab through the slot in the device.

2.5 mm Audio Adapter

✓ **NOTE** The Audio Adapter is available for the TC51 standard configuration.

The 2.5 mm Audio Adapter plugs into the TC51 and connects to a wired headset with a 2.5 mm plug.

To attach a 2.5 mm headset:

1. Open the headset jack cover.
2. Insert the 2.5 mm Audio Adapter plug into the headset jack.

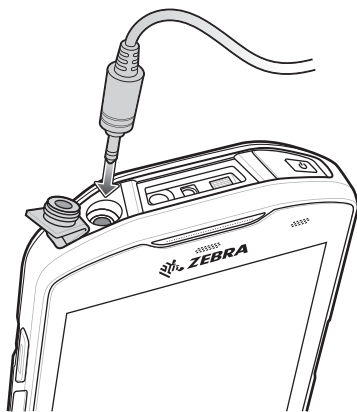

Figure 6-31 Audio Adapter Installation

3. Insert the 2.5 mm headset plug into the jack on the Audio Adapter.

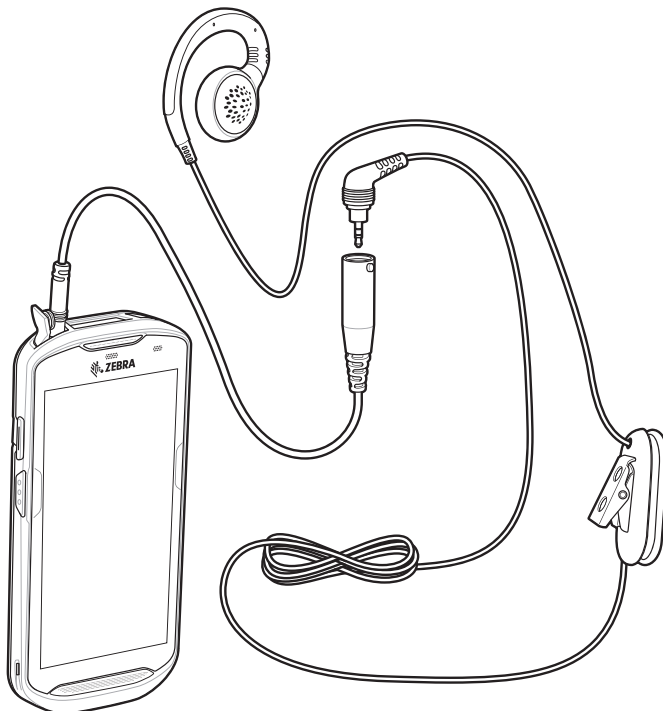

Figure 6-32 Connect Headset to Audio Adapter



CAUTION After removing headset, headset jack cover must be replaced and securely seated to ensure proper device sealing.

3.5 mm Audio Adapter

✓ **NOTE** The Audio Adapter is available for the TC51 standard configuration.

The 3.5 mm Audio Adapter plugs into the TC51 and connects to a wired headset with a 3.5 mm plug.

To attach a 3.5 mm headset:

1. Open the headset jack cover.
2. Insert the 3.5 mm Audio Adapter plug into the headset jack.



Figure 6-33 Audio Adapter Installation

3. Connect the 3.5 mm connector plug of the headset into the 3.5 mm Audio Adapter.

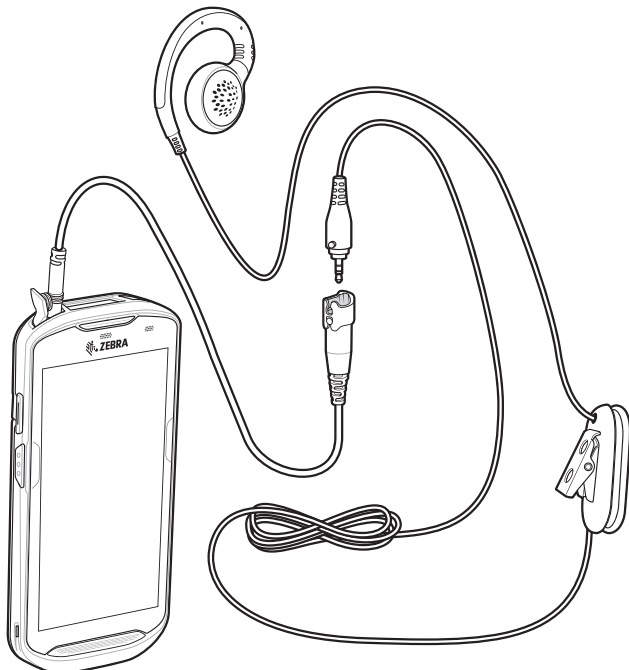

Figure 6-34 Connect Headset to 3.5 mm Adapter Cable



CAUTION After removing headset, headset jack cover must be replaced and securely seated to ensure proper device sealing.

Rugged Charge/USB Cable

The Rugged Charge/USB Cable snaps onto the bottom of the TC51 and removes easily when not in use. When attached to the TC51 allows charging and allows the TC51 to transfer data to a host computer.

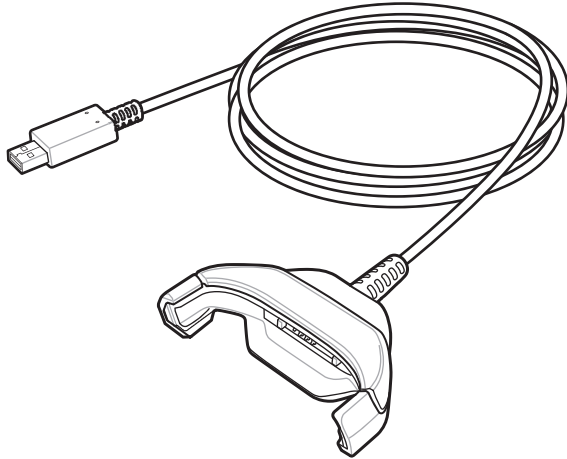

Figure 6-35 *Rugged Charge/USB Cable*

Connecting to TC51

1. Insert the device at an angle into the cable cup until the device touches the bottom of the cup.

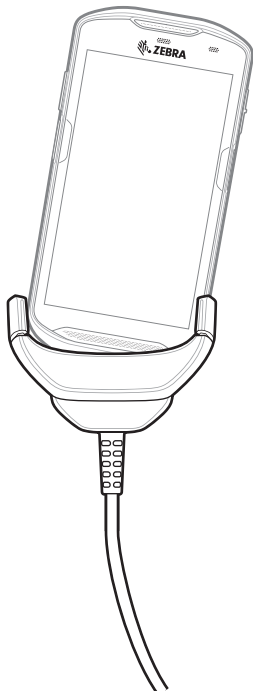

Figure 6-36 *Device Into Cable Cup*

2. Rotate the device into the cup.

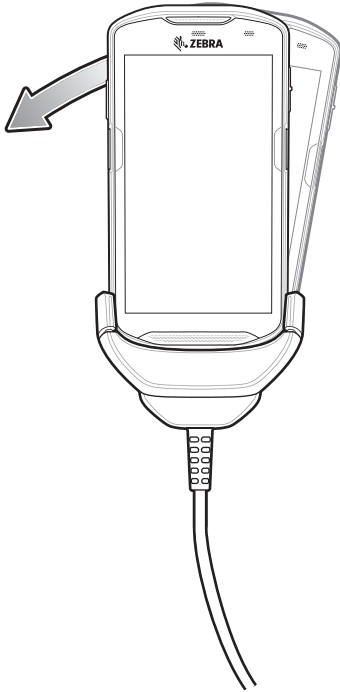

Figure 6-37 *Rotate Device into Cable Cup*

Connecting to TC51 with Rugged Boot

To connect the Rugged Charge/USB Cable to a TC51 with a Rugged Boot:

1. Using thumb and index finger, squeeze the sides of the cup in.

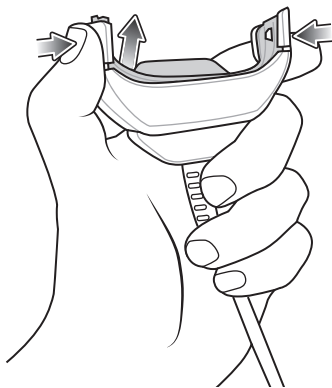

Figure 6-38 *Remove Cable Cup Insert*

2. Lift insert out of cup.

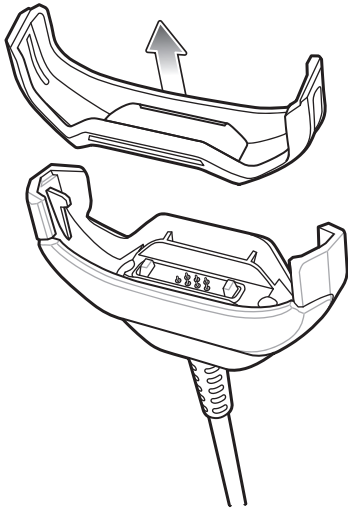

Figure 6-39 *Cable Installation*

3. Align the cable cup with the bottom of the device.
4. Press the device into the cable cup until it is securely in place.

USB Communication

To connect the device to a host computer:

1. Connect the Rugged Charge/USB Cable to the TC51.
2. Connect the USB connector of the cable to a host computer.

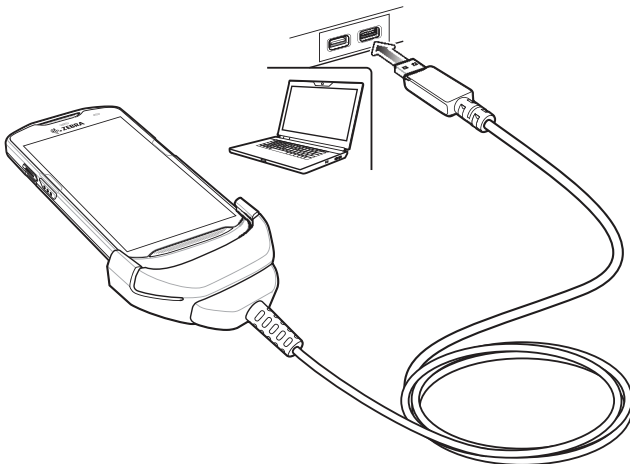

Figure 6-40 *Rugged Charge/USB Cable to Host Computer*

Charging the Device

To charge the device using the Rugged Charge/USB Cable:

1. Connect the Rugged Charge/USB Cable to the TC51.
2. Connect the USB connector of the power supply.



NOTE See *Power Supply* on page 6-42 for information on setting up the power supply.

By default, the device includes an interface connector. If the interface connector is removed for USB Type C cable connectivity, then it must be replaced before charging or receiving an Ethernet IP address if placed in a cradle.

3. Plug to power supply into an power outlet.

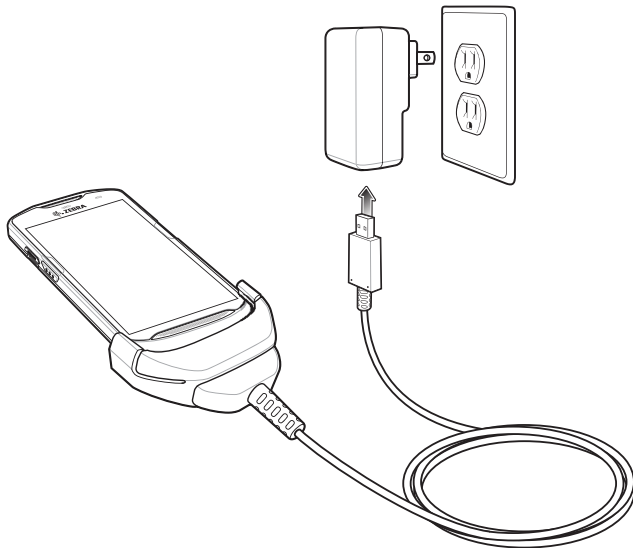

Figure 6-41 *Charging Using the Rugged Charge/USB Cable*

Disconnecting the Rugged Charge/USB Cable

To disconnect the Rugged Charge/USB Cable from the TC51:

1. Rotate the device to one side.

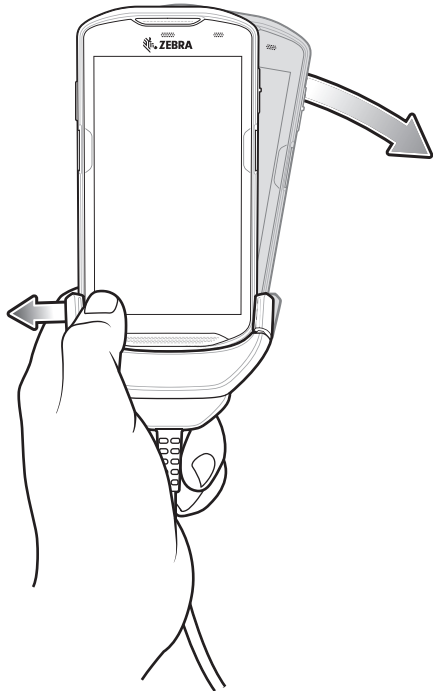

Figure 6-42 Remove Device from Rugged Charge/USB Cable

2. Push the Rugged Charge/USB Cable to the other side.
3. Remove the device from the Rugged Charge/USB Cable.

Battery Charging

Main Battery Charging

The device's Charging/Notification LED indicates the status of the battery charging in the device.

- ✓ **NOTE** Charging using a host computer USB port or a power supply other than the Zebra PWR-WUA5V12W0xx could take longer. See [Table 6-1 on page 6-1](#).

Non-Zebra power supply must provide 5 VDC @ 2.5 A.

The 4,300 mAh (typical) / 4,050 mAh (minimum) battery charges from fully depleted to 90% in approximately 2.5 hours and from fully depleted to 100% in approximately three hours.

- ✓ **NOTE** In many cases the 90% charge provides plenty of charge for daily use. A full 100% charge lasts for approximately 14 hours of use.

To achieve the best fast charging results use only Zebra charging accessories and batteries. Charge batteries at room temperature with the TC51 in sleep mode.

Charging Temperature

Charge batteries in temperatures from 0°C to 40°C (32°F to 104°F). The device always performs battery charging in a safe and intelligent manner. At higher temperatures (e.g. approximately +37°C (+98°F)) the device may for small periods of time alternately enable and disable battery charging to keep the battery at acceptable temperatures. The device indicates when charging is disabled due to abnormal temperatures via its LED.

Trigger Handle

- ✓ **NOTE** The Rugged Boot is required to install the Trigger Handle onto the device. Trigger Handle (p/n TRG-TC51-SNP1-01) does not contain the Rugged Boot and must be purchased separately. Trigger Handle Kit (p/n TRG-TC51-TRG1-01) contains the Rugged Boot.

The Trigger Handle adds a gun-style handle with a scanning trigger to the device. It increases comfort when using the device in scan-intensive applications for extended periods of time.

- ✓ **NOTE** The Trigger Handle is available for the TC51 standard configuration. It is also available for the TC51-HC configuration.

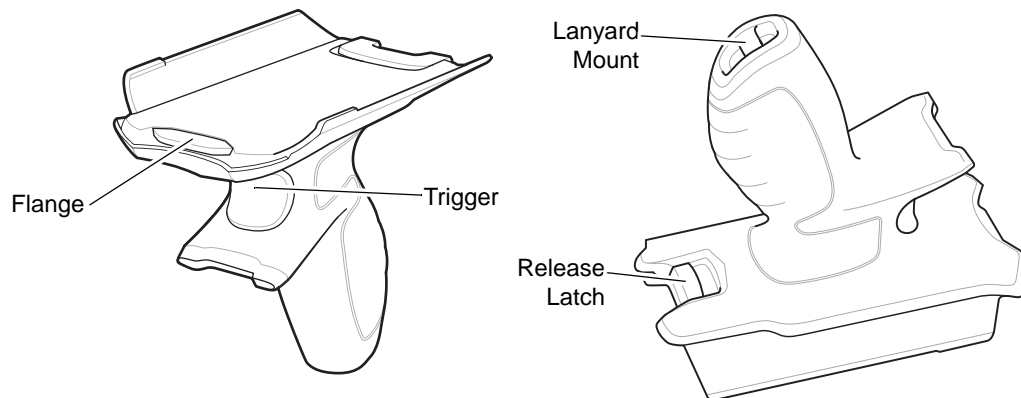

Figure 6-43 Trigger Handle

Installing the Rugged Boot

- ✓ **NOTE** If a Hand Strap is attached to the Rugged Boot, remove prior to installing onto device.

To install the Rugged Boot:

1. Insert the bottom of the device into the bottom of the boot.

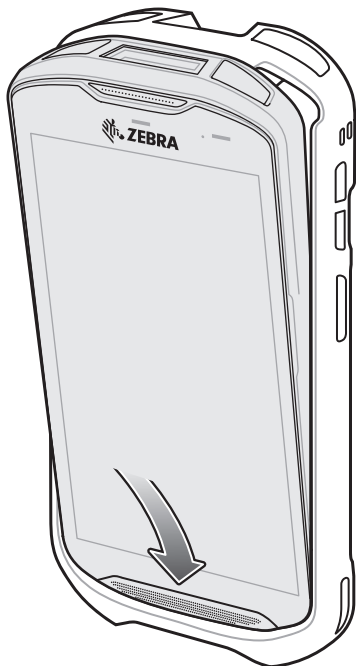

Figure 6-44 *Insert Device into Boot*

2. Lift the top of the Rugged Boot over the top of the device.



Figure 6-45 *Lift Boot Over Device*

3. Push the device into the Rugged Boot.



Figure 6-46 *Push Device into Boot*

Installing the Optional Lanyard

To install the lanyard onto the Trigger Handle:

1. Insert the loop end of the tether into the slot on the bottom of the handle.
2. Feed the lanyard through the loop.

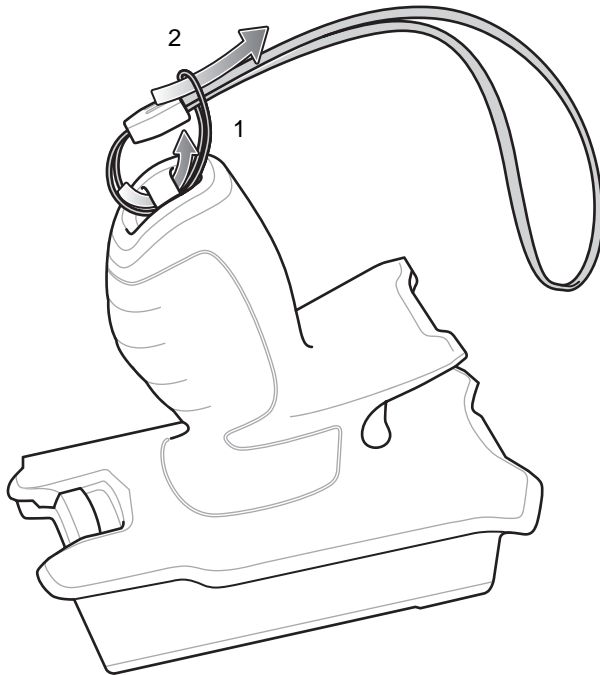

Figure 6-47 *Install Attachment Plate to Handle*

3. Pull the lanyard until the loop tightens.

Inserting the Device into the Trigger Handle

To install the device onto the Trigger handle:

1. Align and insert the flange of the Trigger Handle with the top of the Rugged Boot.

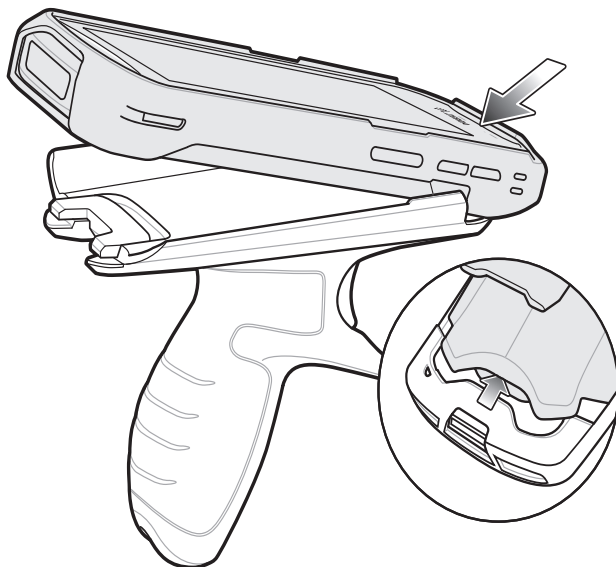

Figure 6-48 *Connect Device to Trigger Handle*

2. Rotate the device down and press down until it snaps into place.



Figure 6-49 *Rotate Device onto Trigger Handle*

Removing the Device from the Trigger Handle

To remove the device from the Trigger Handle:

1. Press Trigger Handle release latch.

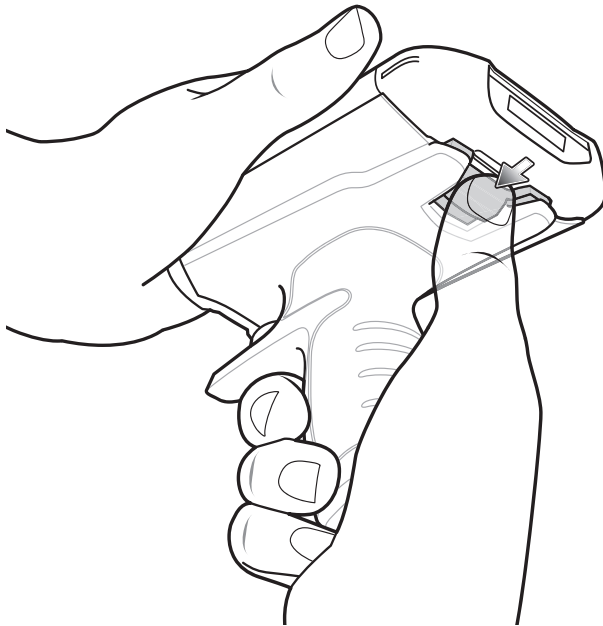

Figure 6-50 *Press Release Latches*

2. Slide the device forward and then rotate the bottom of the device up.

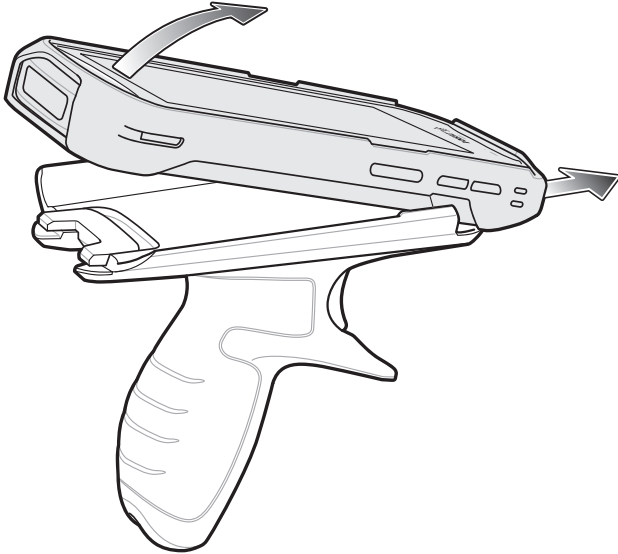

Figure 6-51 *Remove Device from Trigger Handle*

Power Supply

Use the power supply with the Rugged Charge/USB Cable to charge the TC51. The power supply comes in various configuration with different plug adapters for use internationally. To change the plug adapters:

1. Pull the release button down.

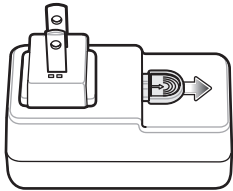

Figure 6-52 *Pull Release Button*

2. Rotate the plug adapter up and out of the power supply.

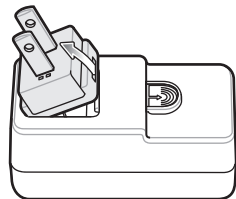

Figure 6-53 *Lift Plug Adapter*

3. Insert the replace plug adapter into the power supply.

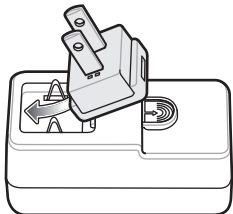

Figure 6-54 *Insert Plug Adapter*

4. Rotate the plug adapter down and snap into place.

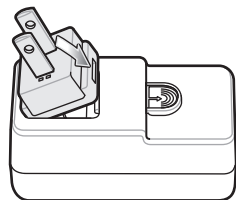

Figure 6-55 *Rotate Plug Adapter in Power Supply*

CHAPTER 7 MAINTENANCE AND TROUBLESHOOTING

This chapter includes instructions on cleaning and storing the device, and provides troubleshooting solutions for potential problems during operation.

Maintaining the TC51

For trouble-free service, observe the following tips when using the TC51:

- In order to avoid scratching the screen, use the supplied stylus or plastic-tipped pens intended for use with a touch-sensitive screen. Never use an actual pen or pencil or other sharp object on the surface of the TC51 screen.
- The touch-sensitive screen of the TC51 is glass. Do not drop the TC51 or subject it to strong impact.
- Protect the TC51 from temperature extremes. Do not leave it on the dashboard of a car on a hot day, and keep it away from heat sources.
- Do not store the TC51 in any location that is dusty, damp, or wet.
- Use a soft lens cloth to clean the TC51. If the surface of the TC51 screen becomes soiled, clean it with a soft cloth moistened with an approved cleanser. For a list of approved cleansers, see *Approved Cleanser Active Ingredients* on page 7-3 or *Approved Disinfectant Cleaners for TC51-Healthcare* on page 7-4.
- Periodically replace the rechargeable battery to ensure maximum battery life and product performance. Battery life depends on individual usage patterns.

Display Best Practices

Image Retention

Image retention may occur when a static image continuously displays for extended periods of time. A user may see a faint remnant of the image even after a new image displays. To prevent image retention:

- set the display to turn off after a few minutes of idle time.
- rotate background images on a periodic basis.
- turn off the display when the device is not in use.
- use a screen saver with the following characteristics:
 - background color set to black
 - use a small moving image (approximately 2% of the display size).
 - move the image randomly across the screen
 - screen saver should be active as long as the static image is used.

Battery Safety Guidelines

- The area in which the units are charged should be clear of debris and combustible materials or chemicals. Particular care should be taken where the device is charged in a non-commercial environment.
- Follow battery usage, storage, and charging guidelines found in this guide.
- Improper battery use may result in a fire, explosion, or other hazard.
- To charge the mobile device battery, the battery and charger temperatures must be between +32°F and +104°F (0°C and +40°C)
- Do not use incompatible batteries and chargers, including non-Zebra batteries and chargers. Use of an incompatible battery or charger may present a risk of fire, explosion, leakage, or other hazard. If you have any questions about the compatibility of a battery or a charger, contact the Global Customer Support Center.
- For devices that utilize a USB port as a charging source, the device shall only be connected to products that bear the USB-IF logo or have completed the USB-IF compliance program.
- To enable authentication of an approved battery, as required by IEEE1725 clause 10.2.1, all batteries will carry a hologram. Do not fit any battery without checking it has the authentication hologram.
- Do not disassemble or open, crush, bend or deform, puncture, or shred battery.
- Severe impact from dropping any battery-operated device on a hard surface could cause the battery to overheat.
- Do not short circuit a battery or allow metallic or conductive objects to contact the battery terminals.
- Do not modify or remanufacture, attempt to insert foreign objects into the battery, immerse or expose to water or other liquids, or expose to fire, explosion, or other hazard.
- Do not leave or store the equipment in or near areas that might get very hot, such as in a parked vehicle or near a radiator or other heat source. Do not place battery into a microwave oven or dryer.
- Battery usage by children should be supervised.
- Please follow local regulations to properly dispose of used re-chargeable batteries.
- Do not dispose of batteries in fire.

- In the event of a battery leak, do not allow the liquid to come in contact with the skin or eyes. If contact has been made, wash the affected area with water for 15 minutes and seek medical advice.
- If you suspect damage to your equipment or battery, contact Customer Support to arrange for inspection.

Cleaning Instructions



CAUTION Always wear eye protection.

Read warning label on alcohol product before using.

If you have to use any other solution for medical reasons please contact the Global Customer Support Center for more information.



WARNING! Avoid exposing this product to contact with hot oil or other flammable liquids. If such exposure occurs, unplug the device and clean the product immediately in accordance with these guidelines.

Approved Cleanser Active Ingredients

100% of the active ingredients in any cleaner must consist of one or some combination of the following: isopropyl alcohol, bleach/sodium hypochlorite¹ (see important note below), hydrogen peroxide, ammonium chloride or mild dish soap.



IMPORTANT Use pre-moistened wipes and do not allow liquid cleaner to pool.

¹ When using sodium hypochlorite (bleach) based products always follow the manufacturer's recommended instructions: use gloves during application and remove the residue afterwards with a damp alcohol cloth or a cotton swab to avoid prolonged skin contact while handling the device.

Due to the powerful oxidizing nature of sodium hypochlorite the metal surfaces on the device are prone to oxidation (corrosion) when exposed to this chemical in the liquid form (including wipes). In the event that these type of disinfectants come in contact with metal on the device, prompt removal with an alcohol-dampened cloth or cotton swab after the cleaning step is critical.

Approved Disinfectant Cleaners for TC51-Healthcare

- Clorox Dispatch® with Bleach
- Clorox Healthcare® Bleach Germicidal Wipes
- Diversey - Dimension® 256 Neutral Disinfectant Cleaner
- Diversey - Virex® II 256
- Metrex CaviWipes®
- Metrex CaviWipes1®
- PDI Easy Screen®
- PDI Sani-Cloth® AF3
- PDI Sani-Cloth® Bleach
- PDI Sani-Cloth® Plus
- PDI Sani-Hands®
- PDI Super Sani Cloth® Germicidal Wipes
- Purell®
- Sani Professional Sani-Wipes®
- SC Johnson Windex® Original Glass Cleaner
- Steris - Coverage Plus® Germicidal Surface Wipes
- The Clorox Company - 409® Glass and Surface Cleaner

Harmful Ingredients

The following chemicals are known to damage the plastics on the device and should not come in contact with the device: acetone; ketones; ethers; aromatic and chlorinated hydrocarbons; aqueous or alcoholic alkaline solutions; ethanolamine; toluene; trichloroethylene; benzene; carbolic acid and TB-lysoform.

Many vinyl gloves contain phthalate additives, which are often not recommended for medical use and are known to be harmful to the housing of the device.

Cleaning Instructions

Do not apply liquid directly to the device. Dampen a soft cloth or use pre-moistened wipes. Do not wrap the device in the cloth or wipe, but gently wipe the unit. Be careful not to let liquid pool around the display window or other places. Allow the unit to air dry before use.



NOTE For thorough cleaning, it is recommended to first remove all accessory attachments, such as handstraps or cradle cups, from the mobile device and to clean them separately.

Special Cleaning Notes

The device should not be handled while wearing vinyl gloves containing phthalates, or before hands are washed to remove contaminant residue after gloves are removed.

If products containing any of the harmful ingredients listed above are used prior to handling the device, such as hand sanitizer that contain ethanolamine, hands must be completely dry before handling the device to prevent damage to the device.

**IMPORTANT**

If the battery connectors are exposed to cleaning agents, thoroughly wipe off as much of the chemical as possible and clean with an alcohol wipe. It is also recommended to install the battery in the terminal prior to cleaning and disinfecting the device to help minimize buildup on the connectors.

When using cleaning/disinfectant agents on the TC51, it is important to follow the directions prescribed by the cleaning/disinfectant agent manufacturer.

Recommended Cleaning Materials

TC51-Standard and Healthcare

- Alcohol wipes
- Lens tissue
- Cotton-tipped applicators
- Isopropyl alcohol

TC51-Healthcare Only

- See *Approved Disinfectant Cleaners for TC51-Healthcare* on page 7-4.

Cleaning Frequency

The cleaning frequency is at the customer's discretion due to the varied environments in which the mobile devices are used and may be cleaned as frequently as required. When dirt is visible, it is recommended to clean the mobile device to avoid build up of particles which make the device more difficult to clean later on.

For consistency and optimum image capture, it is recommended to clean the camera window periodically especially when used in environments prone to dirt or dust.

Cleaning the TC51

Housing

Thoroughly wipe the housing, including all buttons and triggers, using an approved alcohol wipe.

Display

The display can be wiped down with an approved alcohol wipe, but care should be taken not to allow any pooling of liquid around the edges of the display. Immediately dry the display with a soft, non-abrasive cloth to prevent streaking.

Camera and Exit Window

Wipe the camera and exit window periodically with a lens tissue or other material suitable for cleaning optical material such as eyeglasses.

Battery Guide Slots

Insert a cotton-tipped applicator dipped in alcohol into the battery guide rails to clean out debris and then dry with a dry cotton-tipped applicator.

Battery Connector and Locating Magnet Cleaning

To clean the battery connectors and locating magnet:

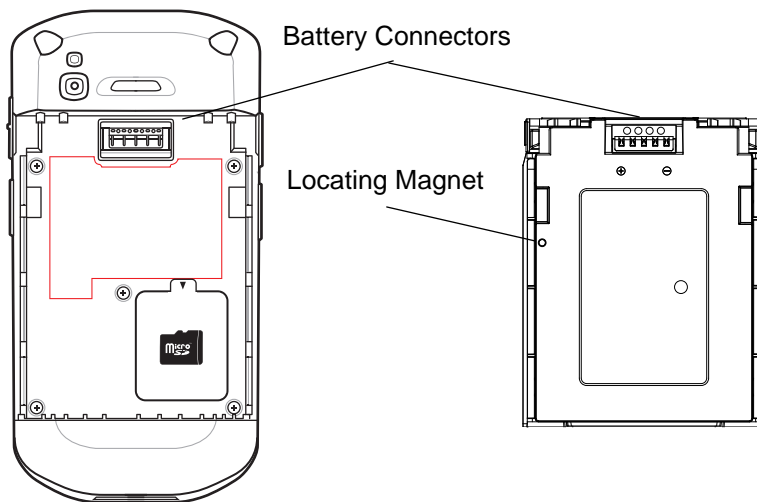

Figure 7-1 *Battery Connectors and Locating Magnet*

1. Remove the main battery from the mobile computer.
2. Dip the cotton portion of the cotton-tipped applicator in isopropyl alcohol.
3. To remove any grease or dirt, rub the cotton portion of the cotton-tipped applicator back-and-forth across the locating magnet and the connectors on the battery and terminal sides. Do not leave any cotton residue on the connectors or magnet.
4. Repeat at least three times.
5. Use a dry cotton-tipped applicator and repeat steps 3 and 4. Do not leave any cotton residue on the connectors or magnet.
6. Inspect the area for any grease or dirt and repeat the cleaning process if necessary.



CAUTION After cleaning the battery connectors or locating magnet with bleach-based chemicals, follow the Battery Connector and Locator Magnet Cleaning instructions to remove bleach from the connectors and locating magnet.

Cleaning Cradle Connectors

To clean the connectors on a cradle:

1. Remove the DC power cable from the cradle.
2. Dip the cotton portion of the cotton-tipped applicator in isopropyl alcohol.
3. Rub the cotton portion of the cotton-tipped applicator along the pins of the connector. Slowly move the applicator back-and-forth from one side of the connector to the other. Do not leave any cotton residue on the connector.
4. All sides of the connector should also be rubbed with the cotton-tipped applicator.
5. Remove any lint left by the cotton-tipped applicator.
6. If grease and other dirt can be found on other areas of the cradle, use a lint-free cloth and alcohol to remove.
7. Allow at least 10 to 30 minutes (depending on ambient temperature and humidity) for the alcohol to air dry before applying power to cradle.

If the temperature is low and humidity is high, longer drying time is required. Warm temperature and low humidity requires less drying time.



CAUTION After cleaning the cradle connectors with bleach-based chemicals, follow the Cleaning Cradle Connectors instructions to remove bleach from the connectors.

Troubleshooting

The following tables provides typical problems that might arise and the solution for correcting the problem.

TC51

Table 7-1 *Troubleshooting the TC51*

Problem	Cause	Solution
After installing the battery, the TC51 does not boot up.	Power button was not pressed.	Press the Power button.
When pressing the power button the TC51 does not turn on.	Battery not charged.	Charge or replace the battery in the TC51.
	Battery not installed properly.	Install the battery properly.
	System crash.	Perform a reset.
When pressing the power button the TC51 does not turn on but two LEDs blink.	Battery charge is at a level where data is maintained but battery should be re-charged.	Charge or replace the battery in the TC51.
Battery did not charge.	Battery failed.	Replace battery. If the TC51 still does not operate, perform a reset.
	TC51 removed from cradle while battery was charging.	Insert TC51 in cradle. See <i>Charging the Battery</i> on page 1-7.
	Extreme battery temperature.	Battery does not charge if ambient temperature is below 0°C (32°F) or above 40°C (104°F).
Cannot see characters on display.	TC51 not powered on.	Press the Power button.
During data communication with a host computer, no data transmitted, or transmitted data was incomplete.	TC51 removed from cradle or disconnected from host computer during communication.	Replace the TC51 in the cradle, or reattach the communication cable and re-transmit.
	Incorrect cable configuration.	See the system administrator.
	Communication software was incorrectly installed or configured.	Perform setup.

Table 7-1 Troubleshooting the TC51 (Continued)



Problem	Cause	Solution
During data communication over Wi-Fi, no data transmitted, or transmitted data was incomplete.	Wi-Fi radio is not on.	Turn on the Wi-Fi radio.
	You moved out of range of an access point.	Move closer to an access point.
During data communication over Bluetooth, no data transmitted, or transmitted data was incomplete.	Bluetooth radio is not on.	Turn on the Bluetooth radio.
	You moved out of range of another Bluetooth device.	Move within 10 meters (32.8 feet) of the other device.
No sound.	Volume setting is low or turned off.	Adjust the volume.
TC51 shuts off.	TC51 is inactive.	The display turns off after a period of inactivity. Set this period to 15 seconds, 30 seconds, 1, 2, 5, 10 or 30 minutes.
	Battery is depleted.	Replace the battery.
Tapping the window buttons or icons does not activate the corresponding feature.	The device is not responding.	Reboot the device.
A message appears stating that the TC51 memory is full.	Too many files stored on the TC51.	Delete unused memos and records. If necessary, save these records on the host computer (or use an SD card for additional memory).
	Too many applications installed on the TC51.	Remove user-installed applications on the TC51 to recover memory. Select  >  Apps . Select the unused application and tap UNINSTALL .

Table 7-1 *Troubleshooting the TC51 (Continued)*

Problem	Cause	Solution
The TC51 does not decode with reading bar code.	Scanning application is not loaded.	Load a scanning application on the TC51 or enable DataWedge. See the system administrator.
	Unreadable bar code.	Ensure the symbol is not defaced.
	Distance between exit window and bar code is incorrect.	Place the TC51 within proper scanning range.
	TC51 is not programmed for the bar code.	Program the TC51 to accept the type of bar code being scanned. Refer to the EMDK or DataWedge application.
	TC51 is not programmed to generate a beep.	If the TC51 does not beep on a good decode, set the application to generate a beep on good decode.
	Battery is low.	If the scanner stops emitting a laser beam upon a trigger press, check the battery level. When the battery is low, the scanner shuts off before the TC51 low battery condition notification. Note: If the scanner is still not reading symbols, contact the distributor or the Global Customer Support Center.
TC51 cannot find any Bluetooth devices nearby.	Too far from other Bluetooth devices.	Move closer to the other Bluetooth device(s), within a range of 10 meters (32.8 feet).
	The Bluetooth device(s) nearby are not turned on.	Turn on the Bluetooth device(s) to find.
	The Bluetooth device(s) are not in discoverable mode.	Set the Bluetooth device(s) to discoverable mode. If needed, refer to the device's user documentation for help.
Cannot unlock TC51.	User enters incorrect password.	If the user enters an incorrect password five times, the user is requested to wait for 30 seconds when using a PIN, Pattern or Password.

APPENDIX A TECHNICAL SPECIFICATIONS

The following sections provide technical specification for the device.

TC51

Table A-1 *TC51 Technical Specifications*

Item	Description
Physical Characteristics	
Dimensions	Height: 155 mm (6.1 in.) Width: 75.5 mm (2.9 in.) Depth: 18.6 mm (0.73 in.)
Weight	249 g (8.8 oz)
Display	5.0 in. High Definition (1280 x 720); exceptionally bright, outdoor viewable; optically bonded to touch panel
Touch Panel	Dual mode capacitive touch with stylus (TC51-Standard only) or bare or gloved fingertip input (conductive stylus sold separately); Corning Gorilla Glass 4
Backlight	Light Emitting Diode (LED) backlight
Battery	Rechargeable 4,300 mAh (typical) / 4,050 mAh (minimum) Li-Ion, Power Precision+; Improved battery technology for longer cycle times and real-time visibility into battery metrics for better battery management; Fast charging (2.4 A)
Expansion Slot	User accessible MicroSD up to 32GB SDHC and up to 128GB SDXC, using FAT32 format.
Connection Interface	Universal Serial Bus (USB) 2.0 High Speed (host and client)
Notification	Audible tone; multi-color LEDs, vibration

Table A-1 TC51 Technical Specifications (Continued)

Item	Description
Voice and Audio	Two microphones support with noise cancellation; vibrate alert; speaker; Bluetooth wireless headset support. High quality speaker phone; PTT headset support (TC51-Standard only); Cellular circuit switch voice; HD Voice.
Performance Characteristics	
CPU	Snapdragon 650 64-bit Hexa-Core 1.8GHz ARM Cortex A72, power optimization
Operating System	Android 6.0.1 Marshmallow with Zebra's Mobility Extensions (Mx) (pre-installed on both AOSP and GMS options)
Memory	Standard: 2 GB RAM/16 GB Flash Optional: 4 GB RAM/32 GB Flash
Output Power	USB - 5 VDC @ 500 mA max
User Environment	
Operating Temperature	-10°C to 50°C (14°F to 122°F)
Storage Temperature	-40°C to 70°C (-40°F to 158°F)
Charging Temperature	0° C to 40° C (32°F to 104°F)
Relative Humidity	Operating: 5 to 95% non-condensing
Drop Specification	Multiple 1.2 m (4 ft.) to tile over concrete over operating temperature range. Multiple 1.5 m (5 ft.) to concrete with Rugged Boot over operating temperature range.
Tumble	500 0.5 m (1.6 ft.) tumbles; meets and exceeds IEC tumble specifications
Electrostatic Discharge (ESD)	+/-15 kVDC air discharge, +/-10 kVDC direct discharge, +/- 10 kVDC indirect discharge
Vibration	4 g's PK Sine (5 Hz to 2 kHz); 0.04g ² /Hz Random (20 Hz to 2 kHz); 60 minute duration per axis, 3 axis
Thermal Shock	-40°C to 70°C (-40°F to 158°F) rapid transition
Interactive Sensor Technology (IST)	
Motion Sensor	3-axis accelerometer Gyro; 3-axis accelerometer
Light Sensor	Ambient light sensor to auto adjust display backlight brightness
Proximity Sensor	Automatically detects when the user places the handset against head during a phone call to disable display output and touch input.
Wireless LAN Data and Voice Communications	
Radio	IEEE 802.11 a/b/g/n/ac/d/h/i/k/r/w; Wi-Fi™ certified; IPv4, IPv6; 2X2 MIMO
Data Rates Supported	5GHz: 802.11a/n/ac - up to 866.7 Mbps 2.4GHz: 802.11b/g/n - up to 144.4 Mbps

Table A-1 TC51 Technical Specifications (Continued)

Item	Description
Operating Channels	Chan 1 - 13 (2412 - 2472 MHz) Chan 36 - 165 (5180 - 5825 MHz) Channel Bandwidth: 20, 40, 80 MHz Actual operating channels/frequencies depend on regulatory rules and certification agency
Security and Encryption	WEP (40 or 104 bit); WPA/WPA2 Personal (TKIP, and AES); WPA/WPA2 Enterprise (TKIP and AES) — EAP-TTLS (PAP, MSCHAP, MSCHAPv2), EAP-TLS, PEAPv0-MSCHAPv2, PEAPv1-EAP-GTC and LEAP
Certifications	WFA (802.11n, WMM-PS)
Fast Roam	PMKID caching; Cisco CCKM; 802.11r; OKC
Wireless PAN Data and Voice Communications	
Bluetooth	Class 2, Bluetooth v4.1 (Bluetooth Smart technology); Bluetooth Wideband support HFPv1.6; Bluetooth v4.1 Low Energy (LE)
Data Capture Specifications	
2D Imager	SE4710 imager (1D and 2D) with LED aimer.
Camera	Front — 1.3 MP fixed focus. (TC51-HC) Rear — 13 MP autofocus; f/2.4 aperture; rear camera flash LED generates balanced white light; supports Torch mode.
Near Field Communications (NFC)	ISO 14443 Type A and B; F; FeliCa and ISO 15693 cards; P2P mode and Card Emulation via Host
2D Imager Engine (SE4710) Specifications	
Field of View	Horizontal - 48.0° Vertical - 36.7°
Image Resolution	1280 horizontal X 960 vertical pixels
Roll	360°
Pitch Angle	+/- 60° from normal
Skew Tolerance	+/- 60° from normal
Ambient Light	Sunlight: 10,000 ft. candles (107,639 lux)
Focal Distance	From front of engine: 17.7 cm (7.0 in.)
Laser Aiming Element	Visible Laser Diode (VLD): 655 nm +/- 10 nm Central Dot Optical Power: 0.6 mW (typical) Pattern Angle: 48.0° horizontal, 38.0° vertical
Illumination System	LEDs: Warm white LED Pattern Angle: 80° at 505 intensity

Table A-2 *Data Capture Supported Symbologies*

Item	Description
1D Bar Codes	Code 128, EAN-8, EAN-13, GS1 DataBar Expanded, GS1 128, GS1 DataBar Coupon, UPCA, Interleaved 2 of 5, UPC Coupon Code
2D Bar Codes	PDF-417, QR Code

INDEX

Numerics

1-slot USB/charge only cradle kit	6-1
4-slot battery charger kit	6-2
4-slot charge only cradle with battery charger kit	6-1
5-slot charge only cradle kit	6-1
5-slot Ethernet cradle kit	6-1

A

ActiveEdge touch zone	3-1
adaptive frequency hopping	5-4
airplane mode	1-13
albums	3-16
android keyboard	2-11
applications	2-13
approved cleanser	7-3
audio adapter	6-2

B

basic hand strap	6-2
battery	1-3, 6-2
low power notification	1-12
management	1-11
manager	3-5
optimization	1-13
usage monitoring	1-11
battery charging	1-7
battery manager	3-5
battery swap	1-8
battery usage	1-11
Bluetooth	5-1, 5-4
PIN	5-4
power states	5-5
profiles	5-5
security	5-4

bluetooth	5-4
browser	2-13

C

calculator	2-13
calendar	2-13
camera	1-4, 2-13, 3-10
camera settings	3-13
cleaning	7-3
cleaning instructions	7-4
clock	2-13
Configurations	li
connect to WLAN	5-1
contacts	2-14, 3-9
cradle	
connector cleaning	7-7
cradle mount	6-1

D

data capture	4-1
datawedge	2-14, 4-14
datawedge demo	3-22
DC line cord	6-3
diagnostics	3-40
display	
cleaning	7-5
display settings	1-14
downloads	2-14
DWDEmo	2-14

E

EAP	5-1
Elemesz	3-40
email	2-14

Index - 2 TC51 User Guide

enterprise keyboard 2-9
Ethernet connection 6-17

F

feature 1-2
feedback iii-liv
file browser 2-14, 3-8
file transfer 2-24
finger usage 1-16
font size 1-15

G

gallery 2-14, 3-15

H

hand strap 6-2
hands-free imager 4-2
hard reset 2-22
harmful ingredients 7-4
headset jack 1-3
home screen 2-2
home screen rotation 1-14

I

imager scanning 4-1

K

keyboard 2-11
keyboards
 android 2-9
 enterprise 2-9

L

light sensor 1-3
low battery notification 1-12

M

microSD card 1-4, 1-10
model number lii

N

near field communication 5-1
near field communications 5-8
NFC 5-8
NFC antenna 1-4

notification icons 2-4

P

panoramic 3-11
panoramic photos 3-11
photo settings 3-13
photo transfer 2-24
photos 3-10
 taking photos 3-10
picklist 4-1
power supply 6-3
proximity sensor 1-3
PTT button 1-2
PTT Express 3-25

R

recoding videos 3-12
recording videos 3-12
resetting the device 2-22
resetting 2-22
RS507 scanning 4-6, 4-7
RS6000 scanning 4-5
rugged boot 6-2
rugged charge/USB cable 6-2
RxLogger 3-29

S

scan button 1-2
scanning 4-1, 4-3
scanning application 3-22
screen
 unlocking 2-18
screen font size 1-15
screen rotation 1-14
screen timeout 1-15
security 5-1
sensors A-2
serial number lii
service information liv
set font size 1-15
setting
 camera 3-13
 font 1-15
 notification LED 1-17
 touch panel mode 1-16
 video 3-13
 wakeup sources 1-19
setting date 1-13
setting time 1-13
settings 2-13, 2-16
 display 1-14

soft holster	6-2
soft reset	2-22
sound recorder	3-24
sound recordet	2-16
speaker	1-3
status bar	2-3
status icons	2-4
stylus	6-3
suspend mode	2-23
symbologies	A-4

T

taking a panoramic photo	3-11
taking panoramic photos	3-11
touch mode	1-16
touchscreen	2-8
transferring files using USB	2-23
trigger handle	6-2
trigger handle kit	6-2
troubleshooting	7-8

U

unlocking the screen	2-18
USB	2-23

V

video settings	3-13
videos	3-10, 3-12

W

wakeup sources	1-19
WEP	5-1
wi-fi network	5-1
wireless local area network	5-1
WLAN	5-1
WPA	5-1



Zebra Technologies Corporation, Inc.
3 Overlook Point
Lincolnshire, IL 60069, U.S.A.
<http://www.zebra.com>

© 2017 ZIH Corp and/or its affiliates. All Rights Reserved. ZEBRA and the stylized Zebra head are trademarks of ZIH Corp, registered in many jurisdictions worldwide. Android and Google are trademarks of Google Inc. All other trademarks are the property of their respective owners.

MN-002868-04 Revision A - July 2017