

TC55 USER GUIDE

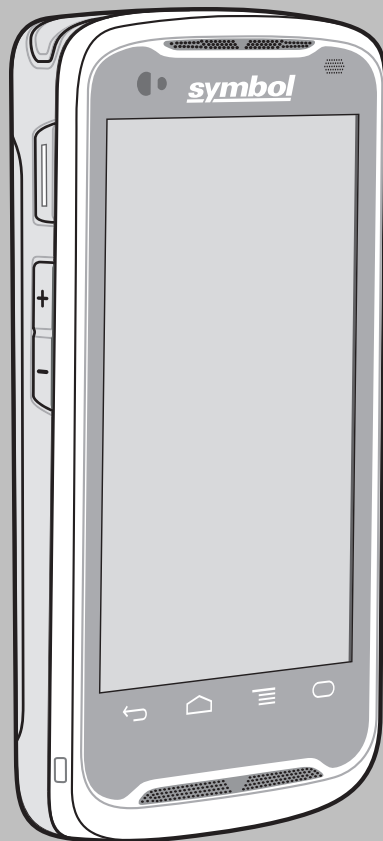

Copyrights

The products described in this document may include copyrighted computer programs. Laws in the United States and other countries preserve for certain exclusive rights for copyrighted computer programs. Accordingly, any copyrighted computer programs contained in the products described in this document may not be copied or reproduced in any manner without the express written permission.

© 2015 Symbol Technologies LLC. All Rights Reserved

No part of this document may be reproduced, transmitted, stored in a retrieval system, or translated into any language or computer language, in any form or by any means, without the prior written permission.

Furthermore, the purchase of our products shall not be deemed to grant either directly or by implication, estoppel or otherwise, any license under the copyrights, patents or patent applications, except for the normal non-exclusive, royalty-free license to use that arises by operation of law in the sale of a product.

Disclaimer

Please note that certain features, facilities, and capabilities described in this document may not be applicable to or licensed for use on a particular system, or may be dependent upon the characteristics of a particular mobile subscriber unit or configuration of certain parameters. Please refer to your contact for further information.

Trademarks

Zebra and the Zebra head graphic are registered trademarks of ZIH Corp. The Symbol logo is a registered trademark of Symbol Technologies LLC.

Revision History

Changes to the original guide are listed below:

Change	Date	Description
A01 Rev. A	10/1/2013	Initial release.
A01 Rev. B	12/12/2013	Update dock settings and Limiting Data connection to 2G sections.
A02 Rev. A	2/17/2014	Add Google Mobile Services support.
A03 Rev. A	4/7/2014	Add TC55CH with LTE Data configuration support.
A04 Rev. A	8/5/2014	Add TC55CH with 3G Voice and Data configuration support.
A04 Rev B	2/10/2015	Zebra rebranding.
A05 Rev. A	3/30/2015	Add 2D imager and Kit Kat support.
A05 Rev. B	9/28/2015	Software update.

Contents

Copyrights.....	3
Revision History.....	5
About This Guide.....	13
Documentation Set.....	13
Configurations.....	13
Chapter Descriptions.....	15
Notational Conventions.....	15
Icon Conventions.....	15
Related Documents.....	16
Service Information.....	16
Chapter 1: Getting Started.....	19
TC55 Features.....	19
Unpacking.....	22
Setup.....	22
Installing the SIM Card.....	22
Installing an Optional microSD Card.....	25
Installing the Battery.....	27
Charging the Battery.....	29
Charging the Main Battery.....	29
Charging LED Status.....	30
Charging Temperature.....	30
Powering On the TC55.....	31
Google Account Setup.....	31
Replacing the 2,940 mAh Battery.....	31
Replacing the 4,410 mAh Battery.....	33
Replacing the microSD Card.....	35
Battery Management.....	37
Monitor Battery Usage.....	37
Low Battery Notification.....	38
Battery Optimization.....	39
Turning Off the Radios.....	39
Setting the Date and Time.....	39
Display Setting.....	40
Setting the Screen Brightness.....	40
Setting Screen Rotation.....	41
Setting Screen Timeout Setting.....	41
Setting Font Size.....	41
Setting Touch Key Light.....	42
Touch Mode.....	42
General Sound Setting.....	43
Setting LED Notifications.....	45
Chapter 2: Using the TC55.....	47
Google Mobile Services.....	47
Home Screen.....	47
Status Bar.....	49
Status Icons.....	49
Notification Icons.....	51

Managing Notifications.....	52
Application Shortcuts and Widgets.....	53
Adding an Application or Widget to the Home Screen.....	53
Moving Items on the Home Screen.....	53
Removing an App or Widget from the Home Screen.....	53
Folders.....	53
Creating a Folder.....	53
Naming Folders.....	53
Removing a Folder.....	54
Changing the Home Screen Wallpaper.....	54
Using the Touchscreen.....	54
Using the On-screen Keyboard.....	55
Applications.....	55
Accessing Applications.....	60
Switching Between Recent Applications.....	60
Un-Locking the Screen.....	61
Single User Mode.....	61
MultiUser Mode.....	63
MultiUser Login.....	63
MultiUser Logout.....	64
Resetting the Device.....	64
Performing a Soft Reset.....	64
Performing a Hard Reset.....	64
Suspend Mode.....	65

Chapter 3: Calls.....67

Making a Call Using the Dialer.....	68
Dialer Dialing Options.....	70
Making a Call Using Contacts.....	70
Making a Call Using Call History.....	71
Making a Conference Call.....	71
Making a Call Using a Bluetooth Headset.....	74
Answering Calls.....	74
Answering Calls with a Bluetooth Headset.....	75
Call Settings.....	76

Chapter 4: Applications.....79

File Browser.....	79
Messaging.....	80
Sending a Text Message.....	80
Sending a Multimedia Message.....	81
People.....	82
Adding People.....	82
Editing People.....	82
Deleting People.....	82
Voice Dialer.....	82
Calling a Person By Name.....	83
Redialing Previous Call.....	83
Dialing By Number.....	83
Opening an Application.....	83
Camera (JellyBean).....	84
Taking Photos.....	84
Taking a Panoramic Photo.....	85
Recording Videos.....	86

Camera Settings.....	87
Video Settings.....	87
Camera (KitKat).....	88
Taking Photos.....	89
Taking a Panoramic Photo.....	91
Recording Videos.....	92
TC55 Photo Settings.....	94
TC55 Video Settings.....	95
Gallery.....	96
Working with Albums.....	97
Share an Album.....	97
Get Album Information.....	97
Deleting an Album.....	98
Working with Photos.....	98
Viewing and Browsing Photos.....	98
Rotating a Photo.....	99
Cropping a Photo.....	99
Setting a Photo as a Contact Icon.....	100
Get Photo Information.....	100
Share a Photo.....	101
Deleting a Photo.....	101
Working with Videos.....	101
Watching Videos.....	101
Sharing a Video.....	102
Deleting a Video.....	102
DataWedge Demonstration.....	103
Movie Studio.....	103
DataWedge Demonstration.....	104
Sound Recorder.....	105
Elemez.....	106
Disabling Elemez Data Collection.....	106
Enabling Elemez Data Collection.....	107
MLog Manager.....	107
SimulScan Demo.....	107
Exporting Sample Forms.....	108
Postal, Transportation and Logistics Example.....	108
Manufacturing Example.....	110
Settings.....	111
Advanced Settings.....	112
Demo Customization.....	112
Default Templates.....	113

Chapter 5: Data Capture..... 115

Linear Imager.....	115
Imaging.....	115
Digital Camera.....	116
CS3070 Bluetooth Scanner.....	116
RS507 Hands-Free Imager.....	116
Scanning Considerations.....	117
Scan Mode.....	117
Bar Code Capture with Linear Imager.....	118
Bar Code Capture with 2D Imager.....	119
Bar Code Capture with Integrated Camera.....	120
Bar Code Capture with CS3070 Bluetooth Scanner.....	121
Bar Code Capture with RS507 Hands-Free Imager.....	122

DataWedge.....	123
Enabling DataWedge.....	123
Disabling DataWedge.....	124
Chapter 6: Wireless.....	125
Wireless Wide Area Networks.....	125
Sharing the Mobile Data Connection.....	125
USB Tethering.....	125
Bluetooth Tethering.....	126
Portable Wi-Fi Hotspot.....	126
Data Usage.....	127
Disabling Data When Roaming.....	128
Limiting Data Connection to 2G Networks.....	129
Locking the SIM Card.....	129
Verizon Network Mode.....	130
Verizon System Select.....	130
Editing the Access Point Name.....	130
Wireless Local Area Networks.....	131
Scan and Connect to a Wi-Fi Network.....	131
Configuring a Wi-Fi Network.....	133
Manually Adding a Wi-Fi Network.....	134
Configuring for a Proxy Server.....	134
Configuring the Device to Use a Static IP Address.....	135
Advanced Wi-Fi Settings.....	136
WLAN Configuration.....	138
Modifying a Wi-Fi Network.....	138
Connecting to a Wi-Fi Network Using WPS.....	139
Remove a Wi-Fi Network.....	139
Bluetooth.....	139
Adaptive Frequency Hopping.....	139
Security.....	140
Bluetooth Profiles.....	140
Bluetooth Power States.....	141
Bluetooth Radio Power.....	141
Enabling Bluetooth.....	141
Disabling Bluetooth.....	141
Discovering Bluetooth Device(s).....	142
Changing the Bluetooth Name.....	143
Connecting to a Bluetooth Device.....	143
Selecting Profiles on the Bluetooth Device.....	143
Unpairing a Bluetooth Device.....	143
Pairing with the CS3070.....	144
CS3070 Numeric Bar Codes for PIN Entry.....	144
Pairing the RS507 Hands-Free Imager Using SSI.....	145
Pairing the RS507 Hands-Free Imager.....	146
Near Field Communications.....	147
Sharing Information Using NFC.....	147
Communication Using NFC.....	148
Pairing with NFC Enabled Bluetooth Devices.....	148
Enterprise NFC Settings.....	149
Chapter 7: Accessories.....	153
TC55 Accessories.....	153
Micro USB Cable.....	154

- Rugged Charge Cable.....155
- Five Slot Charge Only Cradle..... 157
- Vehicle Charge Cradle..... 158
 - Installing Vehicle Cradle on Windshield..... 158
 - Removing the Device from the Vehicle Cradle..... 162
 - Dock Settings..... 163
- Installing the Protective Boot..... 165
- Attaching the Stylus to the Protective Boot..... 166
- Holster..... 168

Chapter 8: Maintenance and Troubleshooting..... 171

- Maintaining the TC55..... 171
- Battery Safety Guidelines.....171
- Cleaning Instructions.....172
 - Cleaning the TC55.....173
 - Connector Cleaning..... 173
 - Cleaning Cradle Connectors.....173
- Troubleshooting.....174
 - Troubleshooting the TC55.....174

Chapter 9: Technical Specifications..... 177

- TC55 Technical Specifications..... 177

About This Guide

This guide provides information on using the TC55 and accessories.



Note:

Screens and windows pictured in this guide are samples and can differ from actual screens.

This guide covers various versions of the device and operating system. Throughout this guide, references are made that distinguish features between these configurations. Operating system version 4.1.2 is referenced as JellyBean and version 4.4.3 is referenced as KitKat®.

Documentation Set

The documentation set for the TC55 provides information for specific user needs, and includes:

- *TC55 Quick Start Guide* - describes how to get the device up and running.
- *TC55 User Guide* - describes how to use the device.
- *TC55 Integrator Guide* - describes how to set up the device and accessories.

Configurations





This guide covers the following configurations:

Configuration	Radios	Display	Memory	Data Capture Options	Operating System
TC55AH Professional Configuration	WLAN: 802.11a/b/g/n (4.1.2) or 802.11a/b/g/n/d/h/i/k/d/r (4.4.3) WPAN: Bluetooth v4.0 (supports Low Energy on 4.4.3 only) and NFC WWAN: LTE	4.3" color WVGA	1 GB RAM / 8 GB Flash	Linear imager and camera, 2D imager and camera or camera	Android-based, Android Open-Source Project 4.1.2 or 4.4.3
TC55AH Standard Configuration	WLAN: 802.11a/b/g/n (4.1.2) or 802.11a/b/g/n/d/h/i/k/d/r (4.4.3) WPAN: Bluetooth v4.0 (supports Low Energy on 4.4.3 only) and NFC	4.3" color WVGA	1 GB RAM / 8 GB Flash	Linear imager and camera or camera	Android-based, Android Open-Source Project 4.1.2 with Google Mobile Services (GMS) or 4.4.3 with GMS

Table continued...

Configuration	Radios	Display	Memory	Data Capture Options	Operating System
	WWAN: LTE				
TC55BH Professional Configuration	WLAN: 802.11a/b/g/n (4.1.2) or 802.11a/b/g/n/d/h/i/k/d/r (4.4.3) WPAN: Bluetooth v4.0 (supports Low Energy on 4.4.3 only) and NFC	4.3" color WVGA	1 GB RAM / 8 GB Flash	Linear imager and camera, 2D imager and camera or camera	Android-based, Android Open-Source Project 4.1.2 or 4.4.3
	WWAN: HSPA+				
TC55BH Standard Configuration	WLAN: 802.11a/b/g/n (4.1.2) or 802.11a/b/g/n/d/h/i/k/d/r (4.4.3) WPAN: Bluetooth v4.0 (supports Low Energy on 4.4.3 only) and NFC	4.3" color WVGA	1 GB RAM / 8 GB Flash	Linear imager and camera or camera	Android-based, Android Open-Source Project 4.1.2 with GMS or 4.4.3 with GMS
	WWAN: HSPA+				
TC55CH with LTE Data Professional Configuration	WLAN: 802.11a/b/g/n WPAN: Bluetooth v4.0 and NFC	4.3" color WVGA	1 GB RAM / 8 GB Flash	Linear imager and camera or camera	Android-based, Android Open-Source Project 4.1.2
	WWAN: CDMA/ EvDO, LTE				
TC55CH with 3G Voice & Data Professional Configuration	WLAN: 802.11a/b/g/n WPAN: Bluetooth v4.0 and NFC	4.3" color WVGA	1 GB RAM / 8 GB Flash	Linear imager and camera or camera	Android-based, Android Open-Source Project 4.1.2
	WWAN: CDMA/ EvDO				

Software Versions

To determine the current software versions touch  >  or  >  **About phone.**

- **Serial number** – Displays the serial number.
- **Model number** – Displays the model number.

- **Android version** – Displays the operating system version.
- **Kernel version** – Displays the kernel version number.
- **Build number** – Displays the software build number.

Chapter Descriptions

Topics covered in this guide are as follows:

- *Getting Started on page 19* provides information on getting the TC55 up and running for the first time.
- *Using the TC55 on page 47* provides information for operating the TC55.
- *Calls on page 67* provides instructions for making phone calls.
- *Applications on page 79* provides information on using applications installed on the TC55.
- *Data Capture on page 115* provides information for capturing bar code data using the linear imager or camera.
- *Wireless on page 125* provides information on the various wireless options.
- *Accessories on page 153* - provides information for using the accessories for the TC55.
- *Maintenance and Troubleshooting on page 171* includes instructions on cleaning and provides troubleshooting solutions for potential problems during TC55 operation.
- *Technical Specifications on page 177* provides the technical specifications for the TC55.

Notational Conventions

The following conventions are used in this document:

- *Italics* are used to highlight the following:
 - Chapters and sections in this and related documents
 - Icons on a screen.
- **Bold** text is used to highlight the following:
 - Dialog box, window, and screen names
 - Drop-down list and list box names
 - Check box and radio button names
 - Button names on a screen.
- Bullets (•) indicate:
 - Action items
 - Lists of alternatives
 - Lists of required steps that are not necessarily sequential
- Sequential lists (for example, lists that describe step-by-step procedures) appear as numbered lists.

Icon Conventions

The documentation set is designed to give the reader more visual clues. The following graphic icons are used throughout the documentation set. These icons and their associated meanings are described below.



Warning: The word WARNING with the associated safety icon implies information that, if disregarded, could result in death or serious injury, or serious product damage.



Caution: The word CAUTION with the associated safety icon implies information that, if disregarded, may result in minor or moderate injury, or serious product damage.



Note: NOTE contains information more important than the surrounding text, such as exceptions or preconditions. They also refer the reader elsewhere for additional information, remind the reader how to complete an action (when it is not part of the current procedure, for instance), or tell the reader where something is located on the screen. There is no warning level associated with a note.

Related Documents

The following conventions are used in this document:

- *TC55 Quick Start Guide*, p/n MN000014Axx
- *TC55 Regulatory Guide*, p/n MN000016Axx
- *TC55 Integrator Guide*, p/n MN000017Axx
- *CS3000 Series Scanner Product Reference Guide*, p/n 72E-136088-xx
- *RS507 Hands-free Imager Product Reference Guide*, p/n 72E-120802-xx
- *MSP Client Software Guide*, p/n 72E-128805-xx
- *MSP Release Notes*, p/n 72E-100160-xx.

For the latest version of this guide and all guides, go to: <http://www.zebra.com/support>

Service Information

If you have a problem with your equipment, contact Global Customer Support Center for your region. Contact information is available at: <http://www.zebra.com/support>.

When contacting the Global Customer Support Center, please have the following information available:

- Serial number of the unit (found on manufacturing label)
- Model number or product name (found on manufacturing label)
- Software type and version number

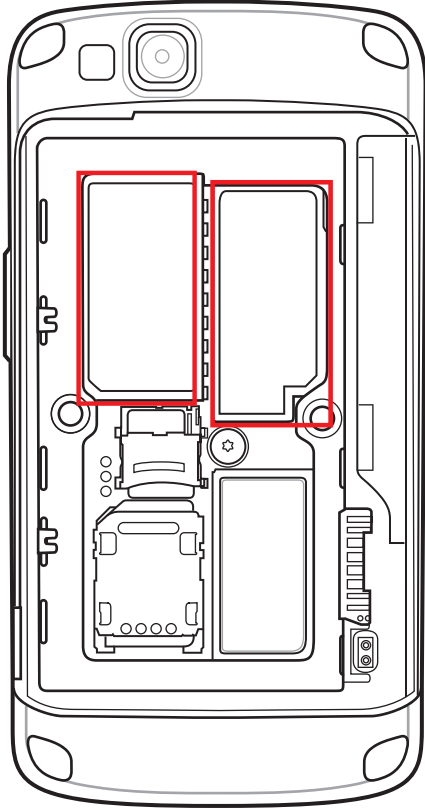
Figure 1: Manufacturing Label Location

We responds to calls by email or telephone within the time limits set forth in support agreements.

If your problem cannot be solved by the Global Customer Support Center, you may need to return your equipment for servicing and will be given specific directions. We are not responsible for any damages incurred during shipment if the approved shipping container is not used. Shipping the units improperly can possibly void the warranty.

If you purchased your product from a business partner, contact that business partner for support.

Chapter 1

Getting Started

This chapter provides the features of the TC55 and explains how to set it up for the first time.

TC55 Features

Figure 2: Front View

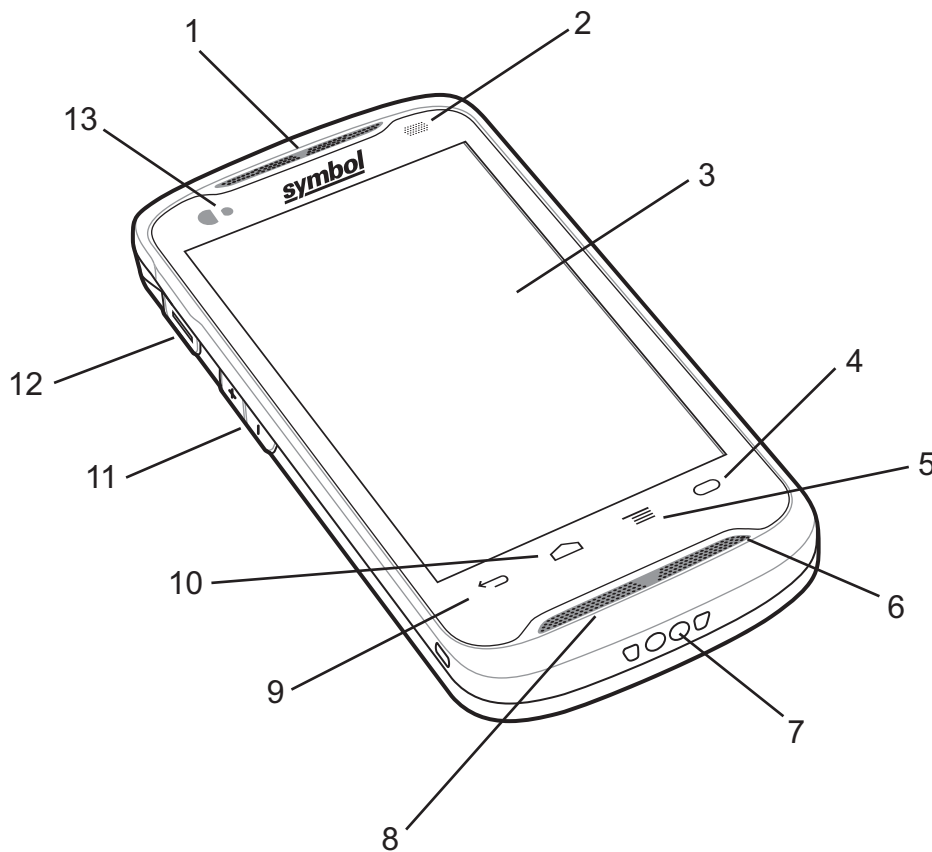

Table 1: Front View Features

Number	Item	Function
1	Receiver	Provides audio in handset mode.
2	LED	Indicates decode functionality. Lights red when scanning is in process. Lights green indicating a successful decode.

Table continued...





Number	Item	Function
		Indicates battery charge state when charging. See Charging LED Status on page 30 .
		Indicates notifications. Lights blue when a notification is received. See Setting LED Notifications on page 45 .
3	Touch Screen	Displays all information needed to operate the TC55.
4		Programmable Button - Can be configured using the Programmable Keys settings. For example purposes the default setting opens the Calculator application.
5		Menu Button - Opens a menu with items that affect the current screen or application. On TC55 with JellyBean GMS, touch and hold to display recently used applications.
6	Primary Micro- phone	Use for communications in handset mode.
7	Charging Contacts	Provides power to the device from cradles and cables.
8	Speakers	Provides audio output for video and music playback. Provides audio in speakerphone mode.
9		Back Button - Displays the previous screen. Closes the keyboard if the on-screen keyboard is open.
10		Home Button - Displays the Home screen with a single touch. Opens the Search application with a touch and hold (long press).
11	Volume Up/Down Buttons	Increase and decrease audio volume.
12	Programmable Button	Initiates scanning when a scan application is enabled (default). Programmable using the Button Remap settings. See <i>TC55 Integrator Guide</i> for more information.
13	Light Sensor/Prox- imity Sensor	Determines ambient light for controlling display backlight intensity and for turning off display when in handset mode.

Figure 3: Back View

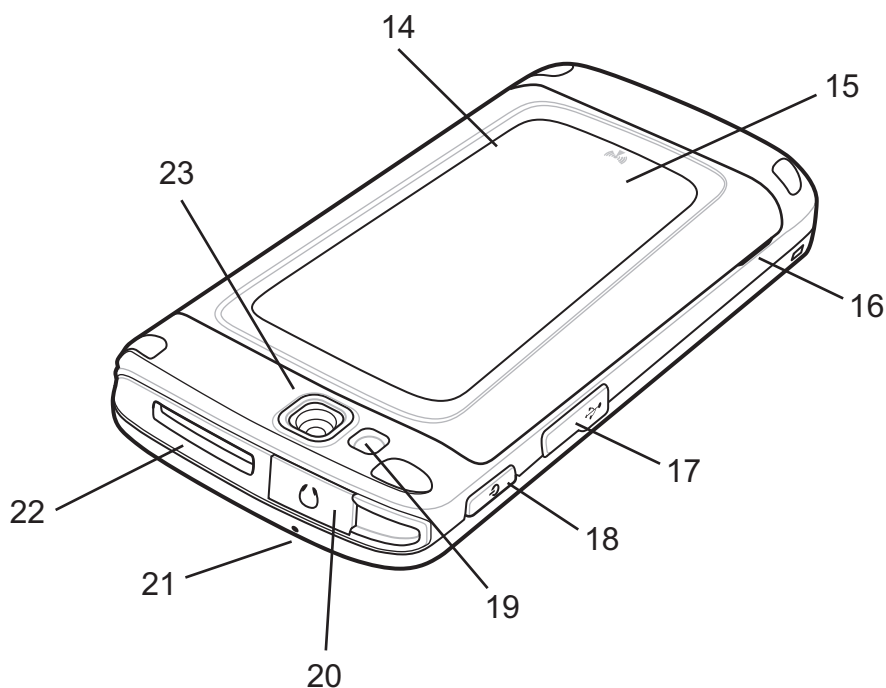

Table 2: Back View Features

Number	Item	Function
14	Battery Cover	Provides access to the battery, SIM and microSD card holders.
15	NFC Antenna	Provides NFC communication with their NFC devices and NFC cards.
16	Battery Cover Notch	Assists in battery cover removal.
17	USB Port	Provides USB client and host communications.
18	Power Button	Press and hold to turn on the TC55. Press to turn the screen on or off. Press and hold to select one of these options: <ul style="list-style-type: none"> • Power off - Turn off the TC55. • Reset - Reboot the TC55 if software stops responding. • Airplane mode - Disable all wireless connections.
19	Flash	Provides illumination for the camera.
20	Headset Jack	Connects to headsets (3.5 mm plug). Note: Do <u>not</u> use 2.5 mm to 3.5 mm adapters. Use only headsets with straight plugs.
21	Secondary Microphone	Use for making voice recordings and communications in speakerphone mode.
22	Exit Window	Provides data capture using the linear imager (optional).

Table continued...

Number	Item	Function
23	Camera	Takes photos, videos and captures bar code data.

Unpacking

Carefully remove all protective material from the TC55 and save the shipping container for later storage and shipping.

Verify the following items are in the box:

- TC55
- Lithium-ion battery (2,940 mAh or 4,410 mAh)
- Charge Cable
- Quick Start Guide
- Regulatory Guide.



Note: Power Supply, p/n PWRS-124306-01R, is required and must be purchased separately.

Inspect the equipment for damage. If any equipment is missing or damaged, contact the Zebra Support Center immediately. See [Service Information on page 16](#) for contact information.

Setup

To start using the TC55 for the first time:

- Install the SIM Card.
- Install microSD card (optional).
- Install the battery.
- Charge the TC55.
- Power on the TC55.
- Set up Google account.

Installing the SIM Card



Caution:

For proper electrostatic discharge (ESD) precautions to avoid damaging the SIM card. Proper ESD precautions include, but not limited to, working on an ESD mat and ensuring that the user is properly grounded.

**Note:**

The TC55 accepts a full size SIM card. If using a micro or nano SIM card, a third-party SIM adapter is required.

TC55AH, TC55BH and TC55CH with LTE Data devices require an activated SIM card. Obtain the card from a service provider. TC55CH with 3G Voice & Data devices do not require a SIM card.

On TC55CH with LTE Data devices, if this is a new account, ensure that the account is set up for LTE data. Obtain a SIM card from Verizon. If you have an existing LTE account that you want to move over to this device, just install your currently active SIM card. No additional activation will be required. If this is a new account: provide the device IMEI number (located on the label under the battery) and the SIM card number to your service provider. After the service provider activates your account, install the SIM card. The TC55CH must be in good LTE coverage for activation to take place. Following the on-screen process.

On TC55CH with 3G Voice & Data devices, if this is a new account, provide the device IMEI number (located on the label under the battery) to your service provider. After the service provider activates your account, following the on-screen process for activation.

Procedure:

- 1 Slide the SIM card holder toward the bottom of the TC55 to unlock.

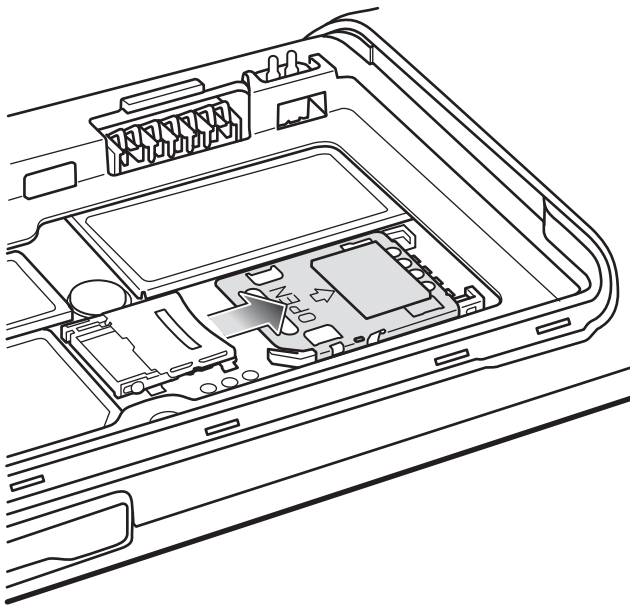
Figure 4: Unlock SIM Card Holder

- 2 Lift the SIM door.
- 3 Insert the SIM card with the cut edge and the contacts facing up.

Figure 5: Install SIM Card

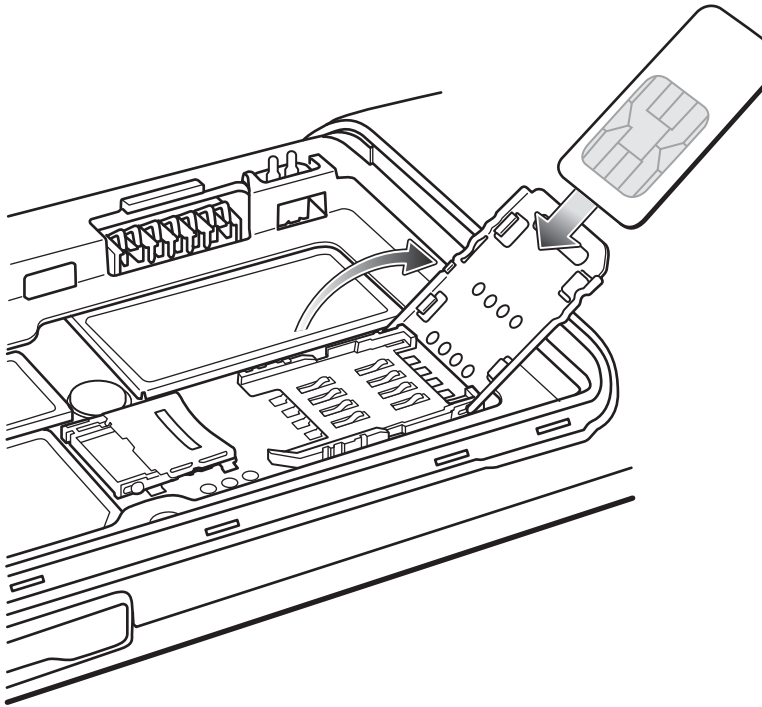

4 Close the SIM card holder.

Figure 6: Close SIM Card Holder

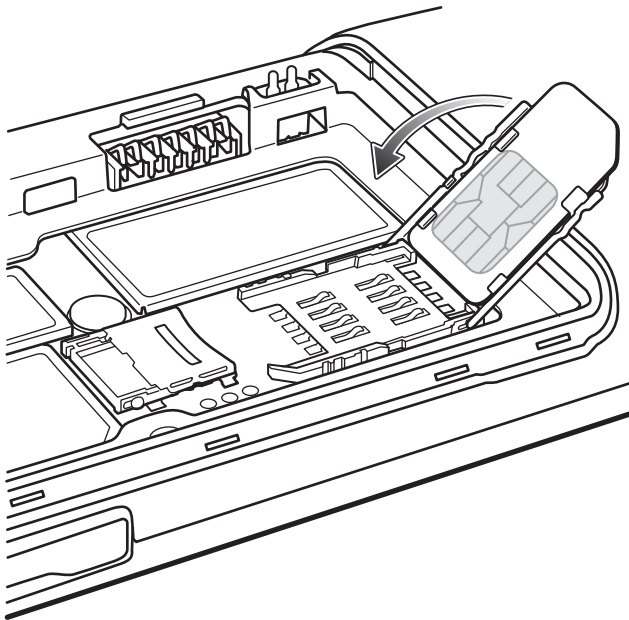

5 Slide the SIM card holder toward the top of the TC55 to lock into place.

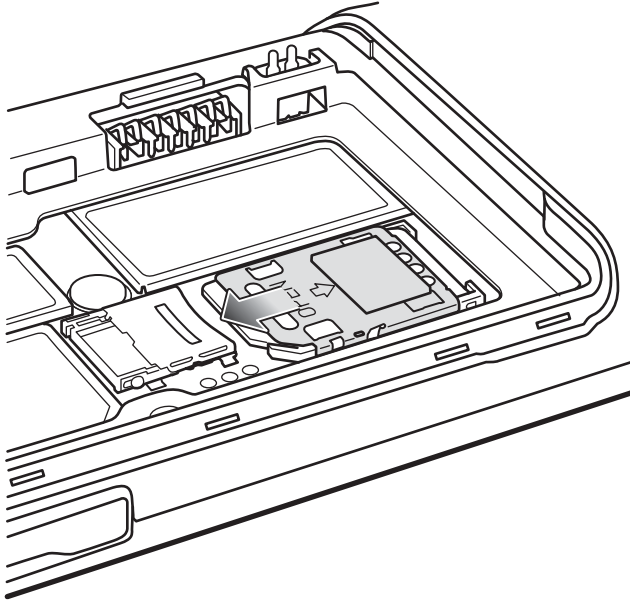
Figure 7: Lock SIM Card Holder

Installing an Optional microSD Card

**Caution:**

For proper electrostatic discharge (ESD) precautions to avoid damaging the SD card. Proper ESD precautions include, but not limited to, working on an ESD mat and ensuring that the user is properly grounded.

Changing the microSD card can change the functionality of the TC55.



Note: The TC55 supports microSD cards up to 32 GB.

Procedure:

- 1 Slide the microSD card door toward the top of the TC55 to unlock.

Figure 8: Unlock microSD Card Door

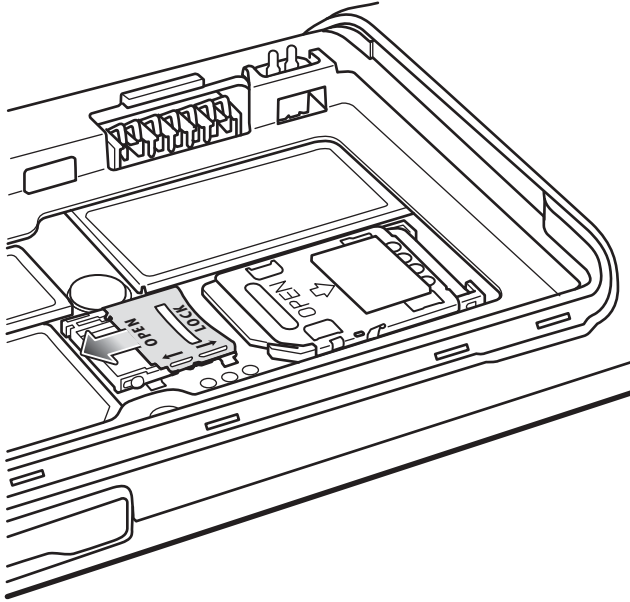

- 2 Lift the SD card door.
- 3 Align the microSD card with the card holder. Ensure that the contacts on the card are facing down and toward the card holder.
- 4 Insert the microSD card into the card holder.

Figure 9: Insert microSD Card

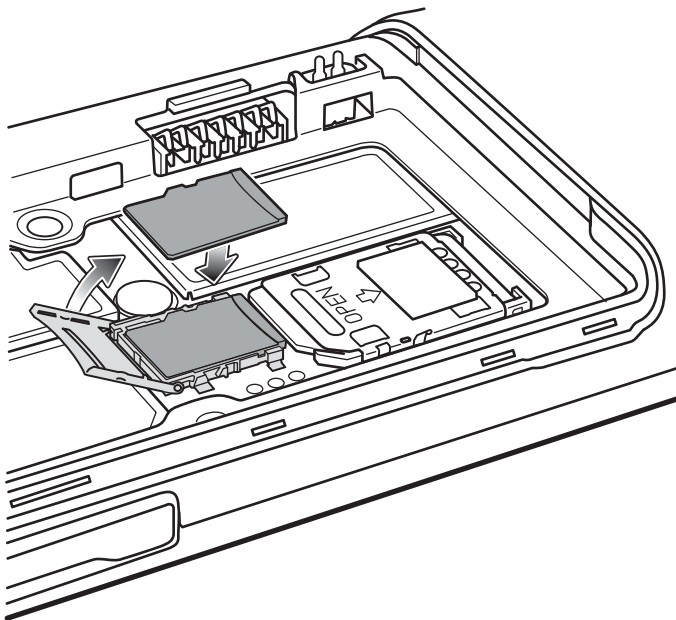

- 5 Close the SD card door.
- 6 Slide the SD card door toward the bottom of the TC55 to lock into place.

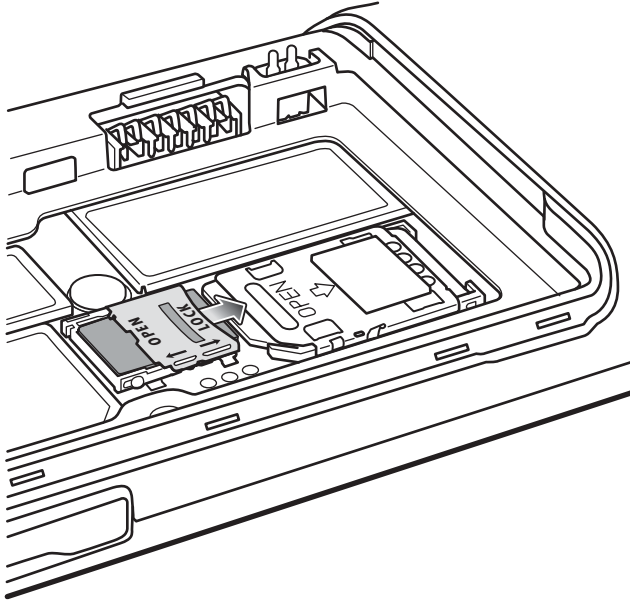
Figure 10: Lock SD Card Door

Installing the Battery

There are two sizes of batteries available for the TC55; a 2,940 mAh battery and a 4,410 mAh battery.

Procedure:

- 1 Align the three tabs on the bottom of the battery with the three slots in the battery compartment.
- 2 Press the battery down and then rotate until it locks into place.

Figure 11: Inserting the 2,940 mAh Battery

Figure 12: Inserting the 4,410 mAh Battery



- 3 Align the battery cover with the back of the device and press the battery cover down until it snaps into place.

Figure 13: Install the Battery Cover

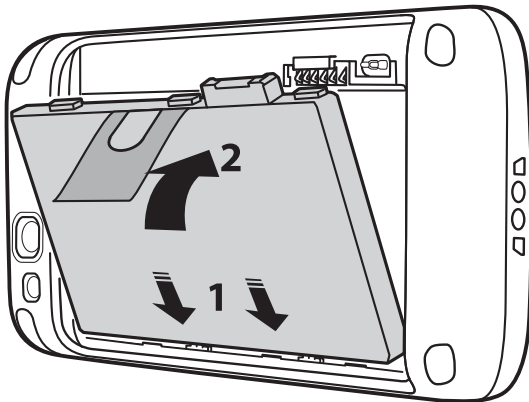
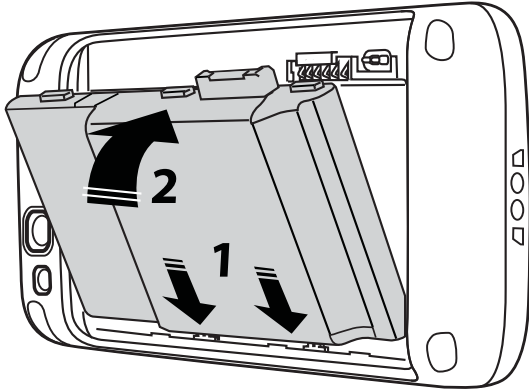
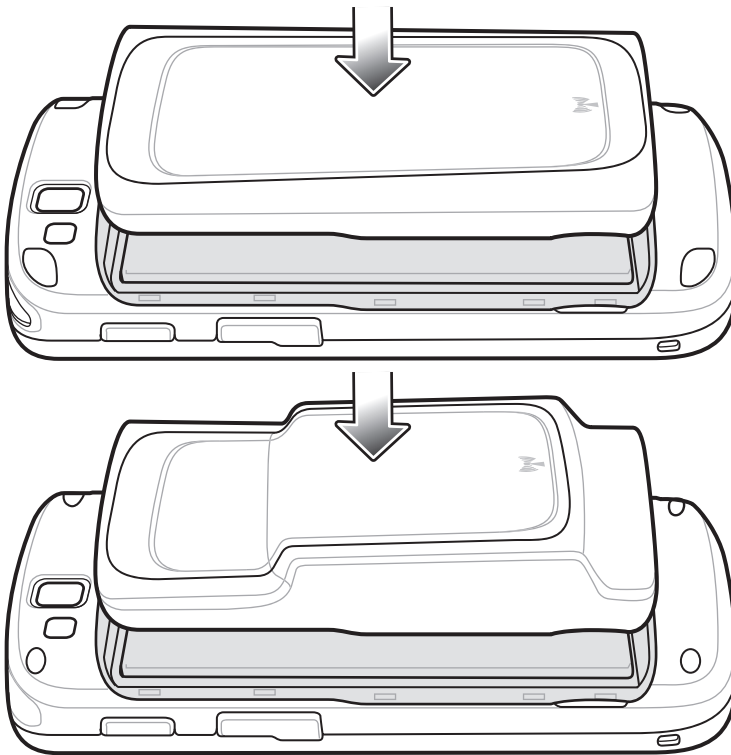

- 4 Press around the edge of the cover to ensure that the battery cover is seated properly.

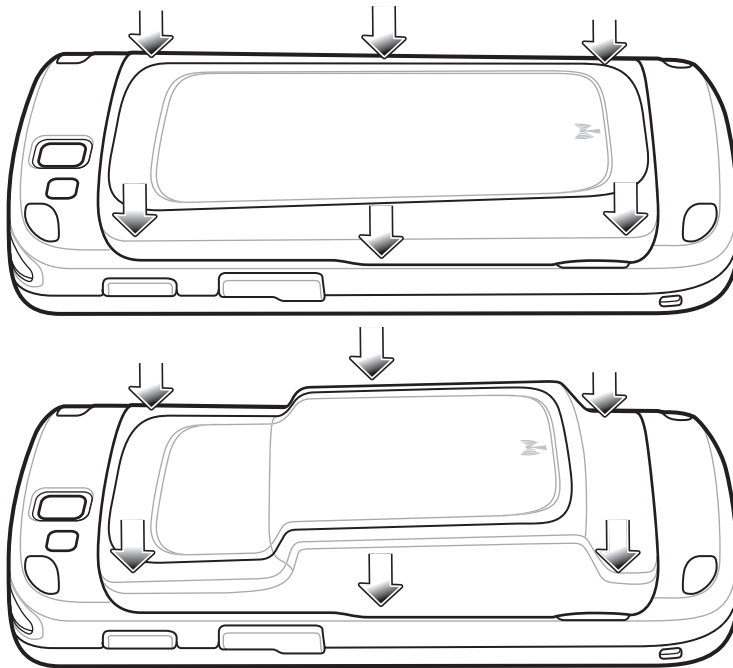
Figure 14: Secure Cover

Charging the Battery



Caution: Ensure that you follow the guidelines for battery safety described in [Battery Safety Guidelines on page 171](#).

Charging the Main Battery

Before using the TC55 for the first time, charge the main battery until the light emitting diode (LED) turns solid green (see [Charging LED Status on page 30](#) for charge status indications). To charge the TC55, use the Rugged Charge Cable with the optional power supply.

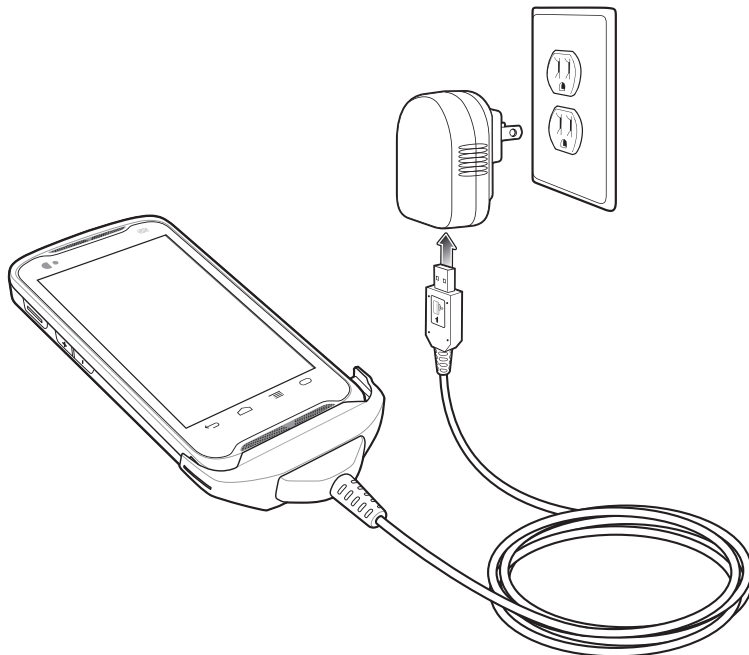

Note: Only connect the Rugged Charge Cable to the optional power supply. Do not connect the Rugged Charge Cable to a host computer for charging.

Figure 15: Connect the Rugged Charge Cable

The TC55 begins charging. The LED blinks green while charging, then turns solid green when fully charged. The 2,940 mAh battery charges in approximately three hours and the 4,410 mAh battery charges in approximately 4.5 hours.

Charging LED Status

Table 3: Charging LED Status

Status	Indications
Off	<p>TC55 is not inserted correctly in the cradle.</p> <p>TC55 is not connected to a power source.</p> <p>Cable or cradle is not powered.</p>
Slow blinking green (1 blink every two seconds)	TC55 is charging.
Solid green	Charging complete.
Slow blinking red (1 blink every two seconds)	Battery is in an extremely low power state (normal slow charging mode).
Fast blinking red (2 blinks / per second)	<p>Charging error:</p> <ul style="list-style-type: none"> • Temperature is too low or too high. • Charging has gone on too long without completion (typically eight hours).

Charging Temperature

Charge batteries in temperatures from 0 °C to 40 °C (32 °F to 104 °F). Note that charging is intelligently controlled by the TC55. To accomplish this, for small periods of time, the TC55 or accessory alternately enables and disables

battery charging to keep the battery at acceptable temperatures. The TC55 or accessory indicates when charging is disabled due to abnormal temperatures via its LED.

Powering On the TC55



Note: Ensure that the battery cover is properly installed. Otherwise, the TC55 will not power on.

If the TC55 did not turn on when the battery was installed, press the Power button. The LED flashes green and the device vibrates. The splash screen displays for about a minute as the TC55 boots.

Google Account Setup



Note:

The TC55 has to be connected to the internet, either through WAN or Wi-Fi, in-order to set up a Google account.

The first time the TC55 starts, the Setup Wizard displays. Follow the on-screen instructions to set up a Google account, configure Google Wallet for purchasing items from the Play Store, entering your personal information, and enabling backup/restore features.

Replacing the 2,940 mAh Battery

Procedure:

- 1 Press the Power button until the menu displays.
- 2 Touch **Power off**.
- 3 Touch **OK**.
- 4 Place thumbnail at notch and lift the battery cover.

Figure 16: Remove the Battery Cover

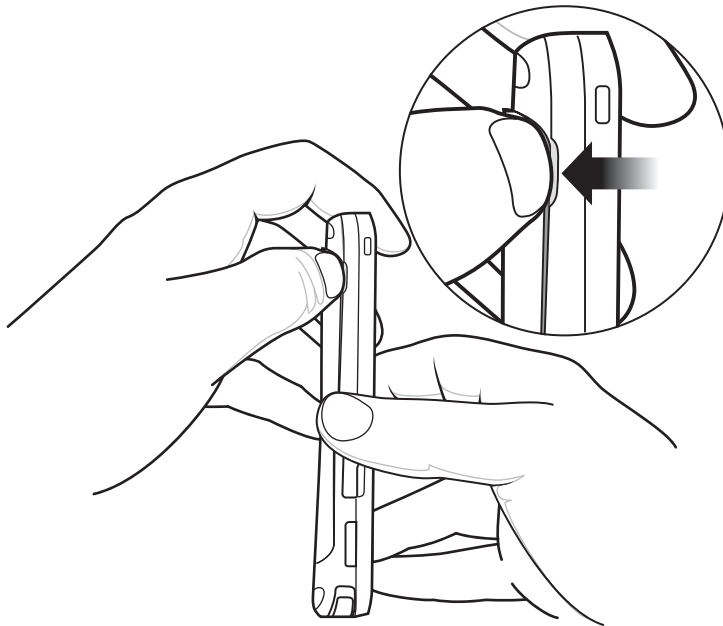

5



Note: Do not pull the battery tab straight out. Pull at a 45 degree angle.

Pull the battery tab down at a 45 degree angle.

Figure 17: Remove 2,940 mAh Battery

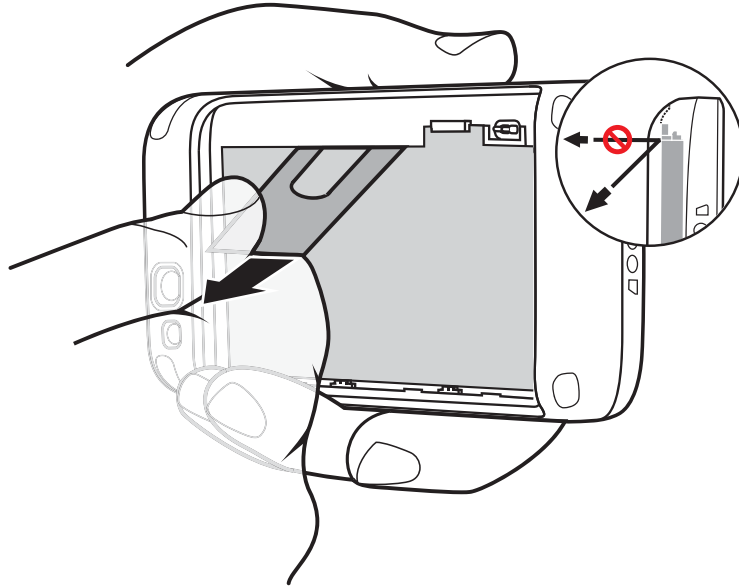

- 6 Remove the battery from the battery compartment.
- 7 Align the three tabs on the bottom of the replacement battery with the three slots in the battery compartment.
- 8 Press the battery down and rotate until it locks into place.

Figure 18: Inserting the 2,940 mAh Battery

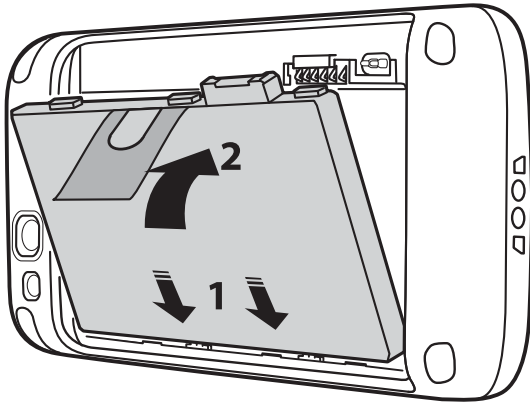

- 9 Align the battery cover with the back of the device.

Figure 19: Align the Battery Cover

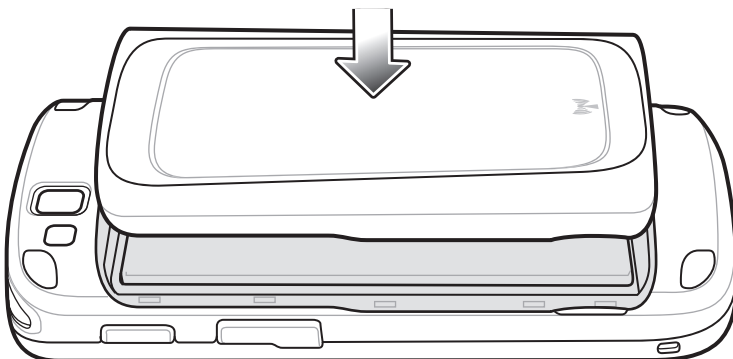

10 Press around the edge of the cover to ensure that the battery cover is seated properly.

Figure 20: Secure the Battery Cover

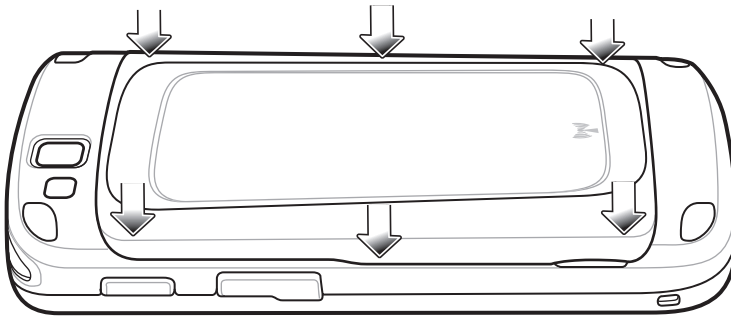

11 Press the Power button to turn on the TC55.

Replacing the 4,410 mAh Battery

Procedure:

- 1 Press the Power button until the menu displays.
- 2 Touch **Power off**.
- 3 Touch **OK**.
- 4 Place thumbnail at notch and lift the battery cover.

Figure 21: Remove the Battery Cover

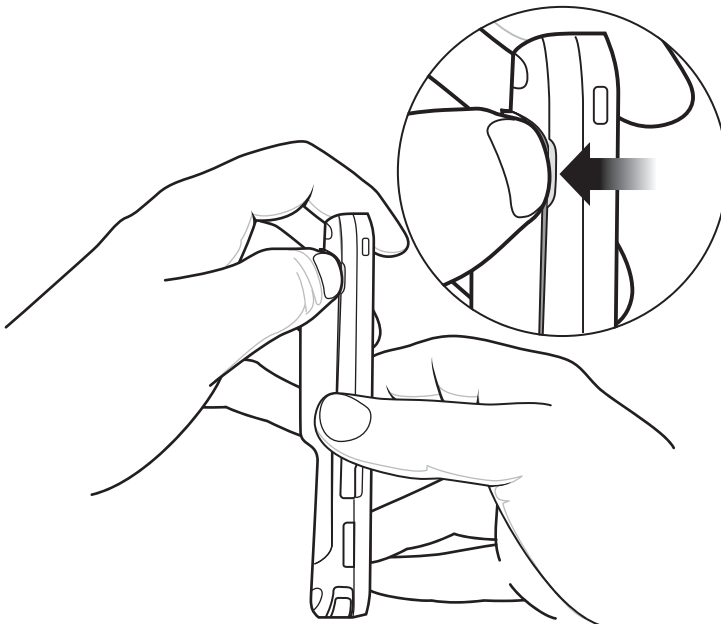

5 With two fingers, press the battery down.

Figure 22: Remove 4,410 mAh Battery

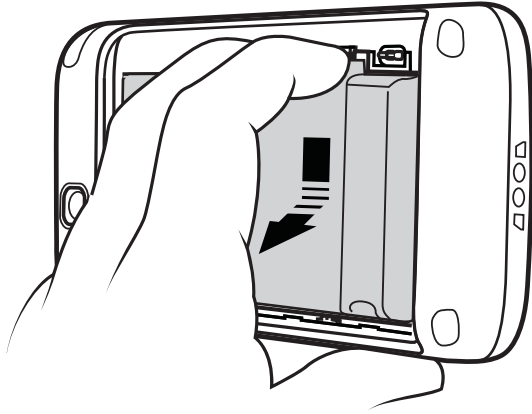

- 6 Rotate the battery out of the compartment.
- 7 Align the three tabs on the bottom of the replacement battery with the three slots in the battery compartment.
- 8 Press the battery down and rotate until it locks into place.

Figure 23: Inserting the 4,410 mAh Battery

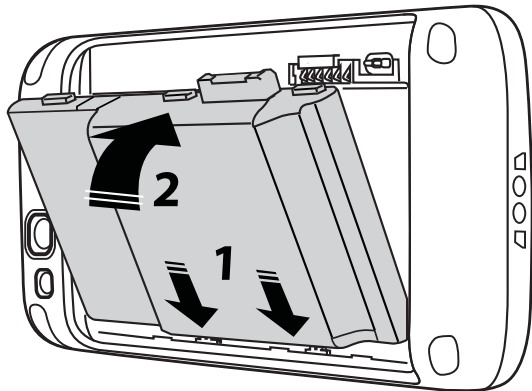

- 9 Align the battery cover with the back of the device.

Figure 24: Align the Battery Cover

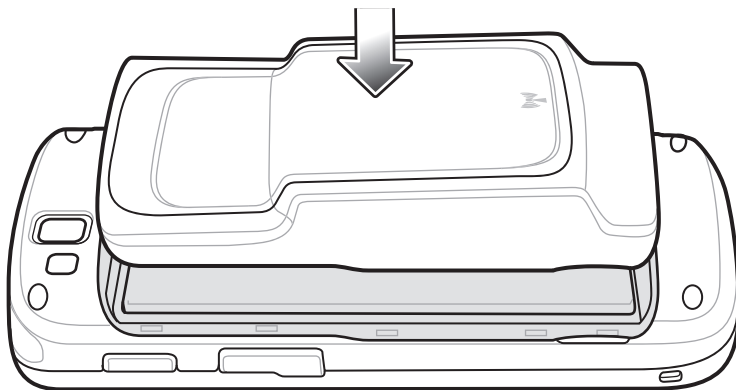

- 10 Press around the edge of the cover to ensure that the battery cover is seated properly.

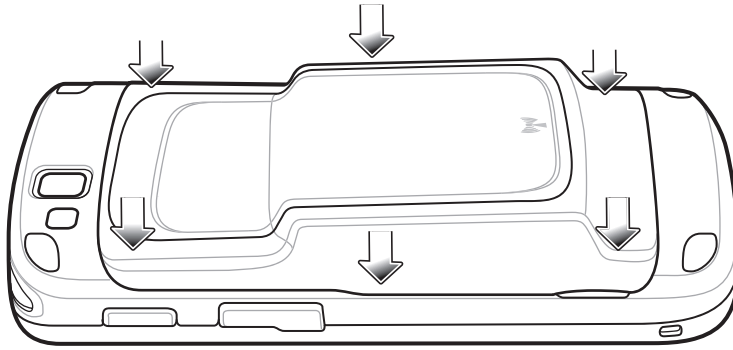
Figure 25: Secure the Battery Cover

11 Press the Power button to turn on the TC55.

Replacing the microSD Card



Caution:

For proper electrostatic discharge (ESD) precautions to avoid damaging the SD card. Proper ESD precautions include, but not limited to, working on an ESD mat and ensuring that the user is properly grounded.

Changing the microSD card can change the functionality of the TC55.

Ensure that you follow the procedures to shut down the TC55 before replacing the microSD card. Data corruption can occur if reading or writing to the microSD card and power is removed.



Note: The TC55 supports microSD cards up to 32 GB.

To replace the microSD card:

Procedure:

- 1 Press the Power button until the menu displays.
- 2 Touch **Power off**.
- 3 Touch **OK**.
- 4 Wait for the device to power off completely.
- 5 Remove the battery cover.
- 6 Remove the battery.
- 7 Slide the microSD card cover up to unlock.

Figure 26: Unlock microSD Card Cover

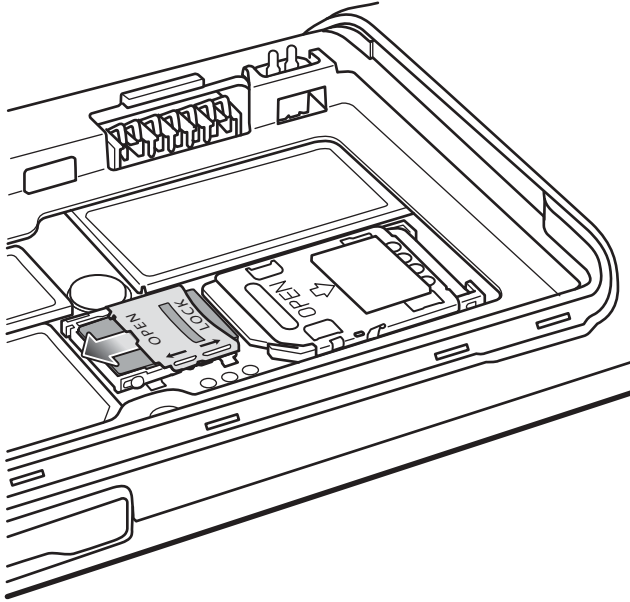

- 8 Lift the microSD card cover.
- 9 Remove the microSD card from the card holder.
- 10 Align the replacement microSD card with the card holder. Ensure that the contacts on the card are facing down and toward the card holder.
- 11 Insert the microSD card into the card holder.

Figure 27: Insert microSD Card

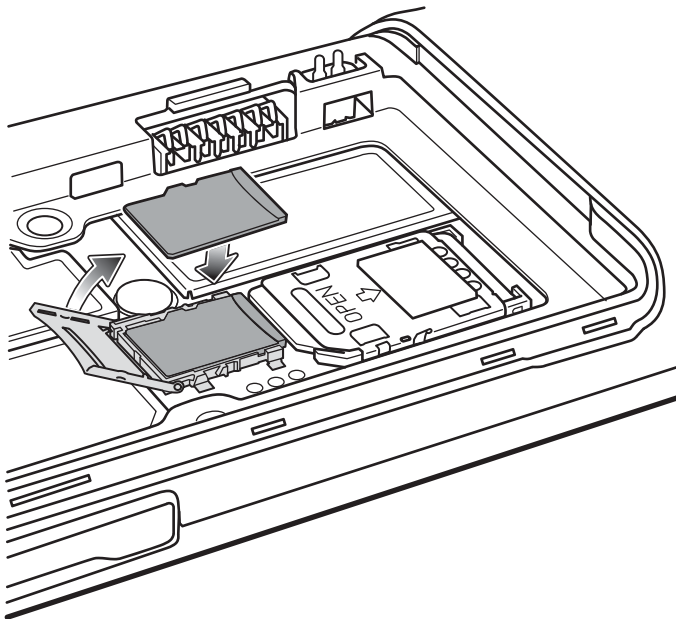

- 12 Close the microSD card cover.
- 13 Slide the microSD card cover down to lock into place.

Figure 28: Lock microSD Card Cover

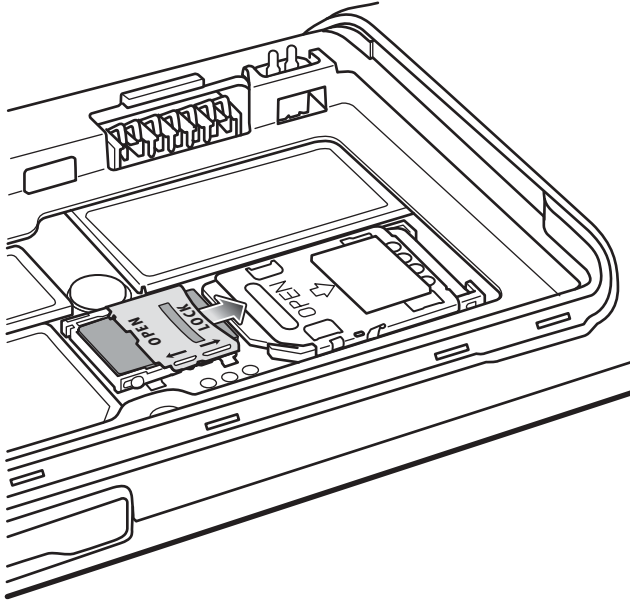

14 Replace the battery.

15 Align the battery cover with the back of the device and press the battery cover down until it snaps into place.





16 Press the Power button to turn on the device.

Battery Management



Note:

Prior to checking the battery charge level, remove the TC55 from any AC power source (cradle or cable).

To check the charge status of the main battery, touch  >  or  >  **About phone** > **Status**.

Battery status indicates that the battery is discharging and **Battery level** lists the battery charge (as a percentage of fully charged).

Monitor Battery Usage

The **Battery** screen lists which applications consume the most battery power. Also use it to turn off applications that were downloaded if they are consuming too much power.

Touch  >  or  > **Battery**.

Figure 29: Battery Screen

The **Battery** screen lists the applications using the battery. The discharge graph at the top of the screen shows the rate of the battery discharge since last charged (short periods of time when connected to a charger are shown as thin green lines at the bottom of the chart), and how long it has been running on battery power.

Touch an application in the **Battery** screen to display details about its power consumption. Different applications display different information. Some applications include buttons that open screens with settings to adjust power use.

Low Battery Notification

When the battery charge level drops below 20% (2,940 mAh battery) or 13% (4,410 mAh battery), the TC55 displays a notice to connect the TC55 to power. The user should charge the battery using one of the charging accessories.

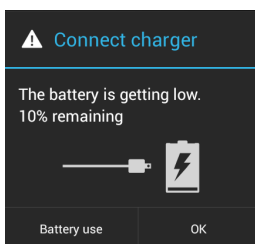
Figure 30: Low Battery Notification

When the battery charge drops below 10% (2,940 mAh battery) or 7% (4,410 mAh battery), the TC55 displays a notice to connect the TC55 to power. The user must charge the battery using one of the charging accessories.

When the battery charge drops below 4% (2,940 mAh battery) or 3% (4,410 mAh battery), the TC55 turns off. Anytime the user then tries to power on the TC55, the following screen appears.

The user must charge the TC55 using one of the charging accessories to retain data.

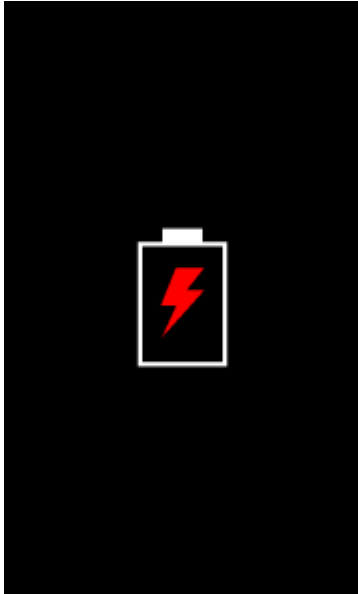
Figure 31: Battery Depleted Screen

The user must charge the TC55 using one of the charging accessories.

Battery Optimization

Observe the following battery saving tips:

- Leave the TC55 connected to AC power at all times when not in use.
- Set the screen to turn off after a short period of non-use. See [Setting Screen Timeout Setting on page 41](#).
- Reduce screen brightness. See [Setting the Screen Brightness on page 40](#).
- Turn off all wireless radios when not in use. Note that the global positioning system (GPS) receiver is only turned on when a GPS application is using the GPS radio.
- Turn off automatic syncing for Email, Calendar, Contacts and other applications.
- Use the **Power Control** widget to check and control the status of radios, the screen brightness, and syncing.
- Minimize use of applications that keep the TC55 from suspending, for example, music, GPS and video applications.

Turning Off the Radios

To turn off all the radios:



Note: Alternately, you can place the device into **Airplane mode** using the **Quick Settings** option.

Procedure:





- 1 Press the Power button until the menu appears.
- 2 Touch **Airplane mode**. The airplane icon  appears in the Status bar indicating that all the radios are off.

Setting the Date and Time

The date and time are automatically synchronized when the TC55 is connected to most WAN networks.

To manually set the date and time:

Procedure:

- 1 From the Home screen, touch .
- 2 Touch  or .
- 3 Touch  **Date & time**.
- 4 Touch **Automatic date & time** to disable automatic date and time synchronization.
- 5 Touch **Automatic time zone** to disable automatic time zone synchronization.
- 6 Touch **Set date**.
- 7 Move the sliders up and down to select the month, date and year.
- 8 Touch **Done**.
- 9 Touch **Set time**.
- 10 Move the sliders up and down to select the hour, minutes and part of the day.
- 11 Touch **Done**.
- 12 Touch **Select time zone**
- 13 Select the current time zone from the list.
- 14 Touch .

Display Setting

Use Display settings to change the screen brightness, change the background image, enable screen rotation, set sleep time and change font size.

Setting the Screen Brightness

To set the screen brightness:

Procedure:





- 1 Touch .
- 2 Touch  or .
- 3 Touch **Display**.
- 4 Touch **Brightness**.

Figure 32: Brightness Dialog Box





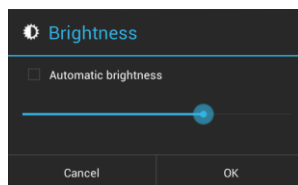

- 5 Check the **Automatic brightness** checkbox to set the device to automatically adjust the brightness using the built-in light sensor. Uncheck the checkbox to set the brightness manually. Use the slider to set a brightness level.
- 6 Touch **OK**.
- 7 Touch .

Setting Screen Rotation

To set the screen rotation:

Procedure:

- 1 Touch .
- 2 Touch  or .
- 3 Touch  **Display**.
- 4 Check **Auto-rotate screen** to set the TC55 to automatically switch orientation when the TC55 is rotated.



Note:





The Home screen does not rotate.

- 5 Touch .

Setting Screen Timeout Setting

To set the screen sleep time:





Procedure:

- 1 Touch .
- 2 Touch  or .
- 3 Touch  **Display**.
- 4 Touch **Sleep**.
- 5 Select one of the sleep values.
 - **15 seconds**
 - **30 seconds**
 - **1 minute** (default)
 - **2 minutes**
 - **5 minutes**
 - **10 minutes**
 - **30 minutes**
- 6 Touch .

Setting Font Size

To set the size of the font in system applications:

Procedure:

- 1 Touch .
- 2 Touch  or .
- 3 Touch  **Display**.
- 4 Touch **Font size**.
- 5 Select one of the font size values.
 - **Small**
 - **Normal** (default)
 - **Large**

- **Huge**

6 Touch .

Setting Touch Key Light

The four touch keys under the screen are backlit. Configure the touch key light to save battery power.

Procedure:

1 Touch .

2 Touch  or .

3 Touch  **Display**.

4 Touch **Touch key light**.

5 Select one of the options.

- **Auto** - The TC55 uses the light sensor to determine the state of the touch key light. When in bright areas, the touch key light will not turn on. When in dim areas, the touch key light will turn on and then turn off after approximately seven seconds. A screen touch turns the touch key light on again (default).
- **Always off** - The touch key light is off.
- **Always on** - The touch key light is on when the screen is on.

Figure 33: Touch Key Light Dialog Box

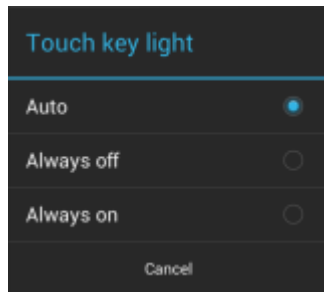

6 Touch .

Touch Mode

The TC55 display is able to detect touches using a finger, a conductive-tip stylus or gloved finger.



Note:

A glove can be made of medical latex, leather, cotton or wool.

For optimal performance use Zebra certified stylus.

Procedure:

1 Touch .

2 Touch  or .

3 Touch  **Display**.

4 Touch **Touch Mode**.

Figure 34: Touch Mode Dialog Box

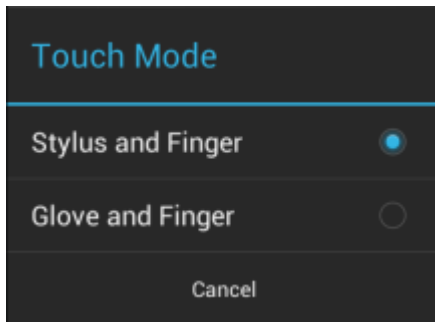

- 5 Touch **Stylus and Finger** to use a finger or a stylus on the screen or touch **Glove and Finger** to use a finger or a gloved finger on the screen.
- 6 Touch .

General Sound Setting





Use the **Sounds** settings to configure media and alarm volumes. On the Home screen, touch  >  or  >  **Sounds**.

Figure 35: Sounds Screen



- **Volumes** – Use to change the volume of media, ringtones, notifications and alarms.

Figure 36: Volumes Dialog Box

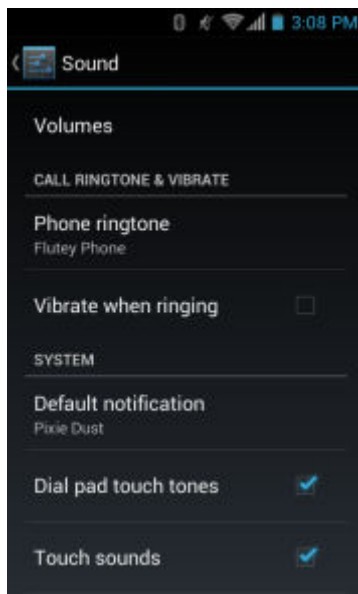
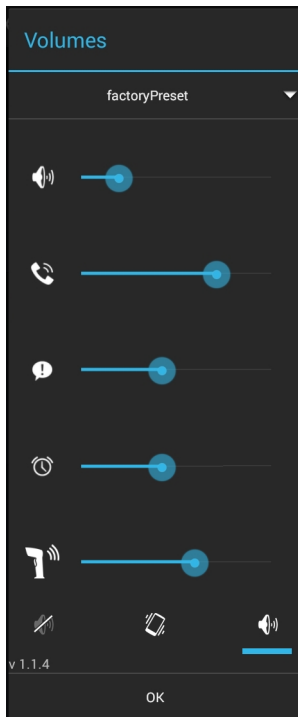







-  - Controls the music and media volume.
-  - Controls the ringtone volume.
-  - Controls the system notification volume.
-  - Controls the alarm clock volume.
-  - Controls the scan good decode beep volume.
- Bottom row icons:
 - +  - Places all sounds except media and alarms in silence mode.
 - +  - Places all sounds except media and alarms in vibrate mode.
 - +  - Places all sounds in sound mode.
- **Audio profile** – Touch to set audio profile. On the **Audio profile** screen, touch **Audio profile**.

Figure 37: Audio Profile Dialog Box

- **General** – Standard audio settings (default).
- **increased clarity** – Increased volume on higher frequencies.
- **Call Ringtone and Vibrate**
 - **Phone ringtone** - Touch to select a ringtone to sound when an incoming call is received.
 - **Vibrate when ringing** - Check to make the device vibrate when a call is received (default – enabled).
- **System**
 - **Dial pad touch tones** - Check to play a sound when a phone key is touched (default – enabled).
 - **Default notification** - Touch to select a sound to play for all system notifications.
 - **Touch sounds** - Check to play a sound when making screen selections (default – enabled).
 - **Screen lock sounds** - Check to play a sound when locking and unlocking the screen (default – disabled).
 - **Vibrate on touch** - Check to have the device vibrate when touching soft keys and on certain screen interactions (default – enabled).

Setting LED Notifications

The TC55 LED can be configured to blink blue when an system or application notification occurs.

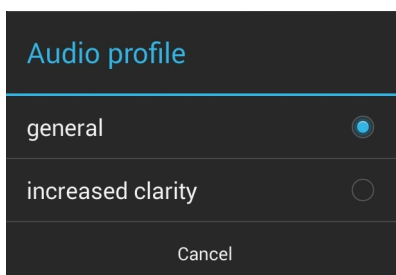
Procedure:





- 1 Touch .
- 2 Touch  or .
- 3 Touch **LED options**.
- 4 Touch the check box next to an option to enable.

Figure 38: LED Options Dialog Box

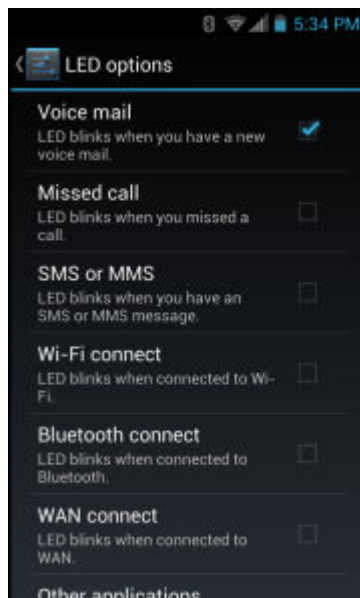

- 5 Touch .

Chapter 2

Using the TC55

This chapter describes the screens, status and notification icons, and controls on the TC55, and provides basic instructions for using the TC55.

Google Mobile Services



Note: This section only applies to TC55 configurations with Google Mobile Services (GMS).



The TC55 with GMS contains applications and services that provide additional functionality to the TC55.

GMS includes:

- **Applications** - GMS adds a variety of Google applications and associated widgets including Chrome, Gmail, Drive and Maps.
- **Services:**
 - **Speech to Text** - Allows for free format speech to text, in many languages for both connected and disconnected network. Launch by touching the microphone icon on the keyboard.
 - **TalkBack Service** - Provides spoken feedback on various parts of the user interface. To enable, go to **Settings > Accessibility**.
 - **Network Location Provider** - Adds a location provider which uses mobile network tower information and Wi-Fi access point information to provide a location without using GPS. To enable, go to **Settings > Location access**.
 - **Widevine DRM** - Enables the digital rights management so that protected content can be played. Enable via DRM Info from the Play Store.
 - **Google Cloud Messaging** - Allows the sending of data from your server to your TC55 and also to receive messages from devices on the same connection.
 - **Backup and Restore** - Allows the users settings and applications to be backed up to a Google server and subsequently restored from that server after a factory reset.
- **Google accounts** - Create and use a Google account to synchronize mail, files, music, photos, contacts and calendar events.

Home Screen

The Home screen displays when the TC55 turns on. Depending upon the configuration, the Home screen might appear different. Contact your system administrator for more information.

After a suspend or screen time-out, the Home screen displays with the lock sliders. Slide  to the right toward  to unlock the screen. For screen locking information see [Un-Locking the Screen on page 61](#).

Alternately, slide  to the left toward  to open the **Camera** application.

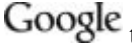
On TC55 with GMS, slide up toward  to open the Google search application.



Note: The layout of the Home screen may vary depending upon the device configuration.

Figure 39: Home Screen Example

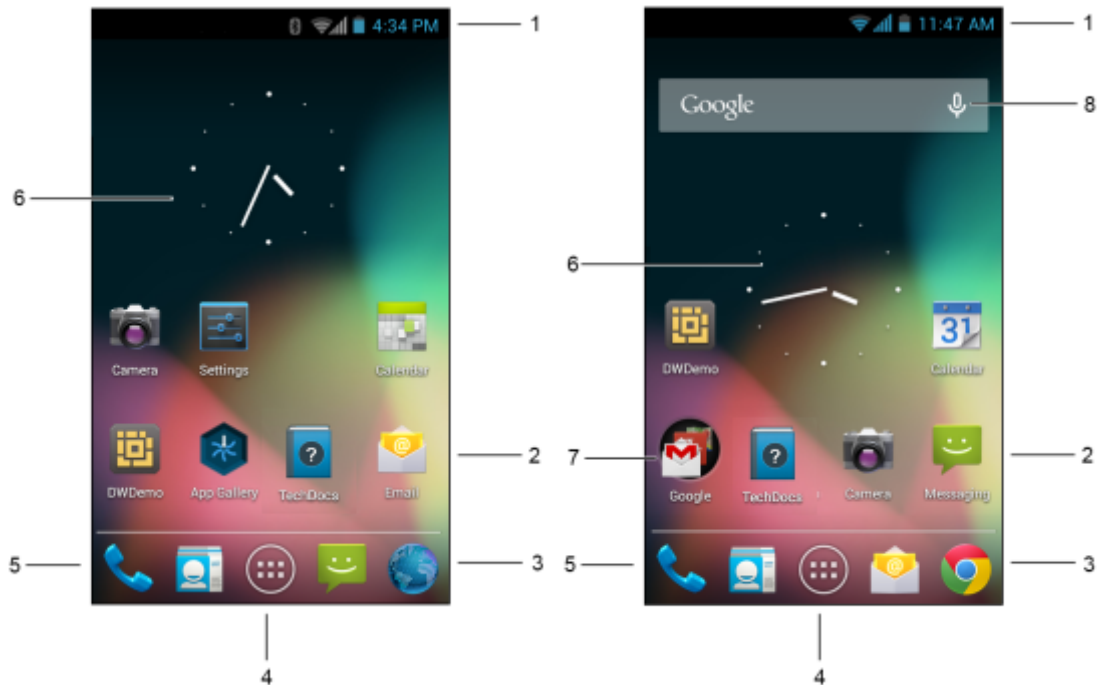

Table 4: Home Screen Items

Item	Description
1 — Status Bar	Displays the time, status icons (right side), and notification icons (left side). For more information see Status Icons on page 49 and Managing Notifications on page 52 .
2 — Shortcut Icons	Opens applications installed on the TC55. See Application Shortcuts and Widgets on page 53 for more information.
3 — Browser Icon	Opens the Browser application. On TC55 with GMS, opens the Chrome browser.
4 — All Apps Icon	Opens the APPS window.
5 — Phone Icon	Opens the Dialer window. Not available on TC55CH configurations.
6 — Widgets	Launches stand-alone applications that run on the Home screen. See Application Shortcuts and Widgets on page 53 for more information.
7 — Google Folder	On TC55 with GMS, opens a list of Google applications available on the device.
8 — Voice Search	On TC55 with GMS, allows users to use Google Search by speaking into the TC55 microphone.

The Home screen provides four additional screens for placement of widgets and shortcuts. Swipe the screen left or right to view the additional screens.

Status Bar

The Status bar displays the time, notification icons (left side) and status icons (right side).

Figure 40: Notification and Status Icons



Table 5: Home Screen Items

Item	Description
1	Notification icons.
2	Status icons.

If there are more notifications than can fit in the Status bar,  displays indicating that more notifications exist. Open the Notifications panel to view all notifications and status.

Status Icons

Table 6: Status Icons







Icon	Description
	Indicates that GPS is in use.
	Indicates that the TC55 is searching location data.
	Indicates that the Alarm is active.
	Indicates that all sounds except media and alarms are silenced and vibrate mode is active.
	Indicates that the ringer is silenced.
	Microphone is muted during a call.
	Indicates that the battery is fully charged.

Table continued...





















Icon	Description
	Indicates that the battery is partially drained.
	Indicates that the battery charge is low.
	Indicates that the battery charge is very low.
	Indicates that the battery is charging.
	Indicates that the Airplane Mode is active. All radios are turned off.
	Indicates that Bluetooth is on.
	Indicates that the TC55 is connected to a Bluetooth device.
	Connected to a Wi-Fi network.
	No Wi-Fi signal.
	Mobile network signal strength.
	No mobile network signal.
	Connected to an 4G LTE network.
	Connected to an 4G network.
	Connected to a 3G network.
	Connected to an HSPA network.
	Connected to an EDGE network.
	Connected to an GPRS network.
	Roaming from a network.
	No SIM card installed.

Table continued...

Icon	Description
	Indicates that Hearing Aide Compatibility (HAC) feature is enabled.

Notification Icons

Table 7: Notification Icons



























Icon	Description
	Indicates that more notifications are available for viewing.
	Indicates that data is syncing.
	Indicates incoming email.
	On TC55 with GMS, indicates incoming Google mail.
	Indicates an upcoming event.
	Indicates that an open Wi-Fi network is available.
	Indicates that a song is playing.
	Indicates that a problem with sign-in or sync has occurred.
	Indicates that the TC55 is uploading data.
	Indicates that the microSD card is almost full.
	Indicates that the TC55 is downloading data when animated and download is complete when static.
	Indicates that the TC55 is connected via USB cable.
	Indicates that the TC55 is connected to or disconnected from virtual private network (VPN).
	Preparing SD card.
	Indicates that USB debugging is enabled on the TC55.
	Indicates that the MultiUser feature is enabled.

Table continued...

Icon	Description
	Indicates that a new user is logging in.
	Indicates that the TC55 has received a text message.
	Indicates a missed call. (Not available on TC55CH with LTE Data).
	Indicates that the TC55 is in car mode.
	Indicates that diagnostics data has been sent using the Elemez application.
	Indicates that Bluetooth tethering is active.
	Indicates that USB tethering is active.
	Indicates that Wi-Fi hotspot is active.
	On TC55 with GMS, indicates a Google Hangout chat notification.
	On TC55 with GMS, indicates a Google+ notification.

Managing Notifications

Notification icons report the arrival of new messages, calendar events, and alarms, as well as ongoing events. When a notification occurs, an icon appears in the Status bar with a brief description. See [Table 7: Notification Icons on page 51](#) for a list of possible notification icons and their description. Open the **Notifications** panel to view a list of all the notifications.

To open the Notification panel drag the Status bar down from the top of the screen.

Figure 41: Notification Panel

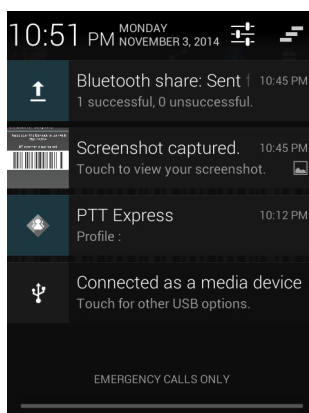

To respond to a notification, open the Notifications Panel and then touch a notification. The Notifications Panel closes and the subsequent activity is dependent on the notification.

To clear all notifications, open the Notifications Panel and then touch . All event-based notifications are removed. Ongoing notifications remain in the list.

To close the Notification Panel, drag the bottom of the Notifications Panel to the top of the screen or touch .

Application Shortcuts and Widgets

Application shortcuts placed on the Home screen allow quick and easy access to applications. Widgets are self-contained applications placed on the Home screen to access frequently used features.

Adding an Application or Widget to the Home Screen

Procedure:

- 1 Go to the desired Home screen.
- 2 Touch .
- 3 Swipe right, if necessary, to find the application icon or widget.
- 4 Touch and hold the icon or widget until the Home screen appears.
- 5 Position the icon on the screen and then release.

Moving Items on the Home Screen

Procedure:

- 1 Touch and hold the item until it floats on the screen.
- 2 Drag the item to a new location. Pause at the edge of the screen to drag the item onto an adjacent Home screen.
- 3 Lift finger to place the item on the Home screen.

Removing an App or Widget from the Home Screen

Procedure:

- 1 Go to the desired Home screen.
- 2 Touch and hold the application shortcut or widget icon until it floats on the screen.
- 3 Drag the icon to  **Remove** on the top of the screen and then release.

Folders

Use **Folders** to organize similar applications together. Tap the folder to open and display items in the folder.

Creating a Folder

To create a folder, there must be at least two app icons on the Home screen.

Procedure:

- 1 Go to the desired Home screen.
- 2 Touch and hold on one application icon.
- 3 Drag the icon and stack on top of another icon.
- 4 Lift and release.

Naming Folders

Procedure:

- 1 Touch the folder.

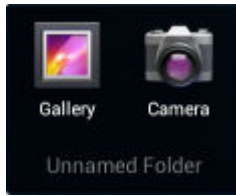
Figure 42: Open Folder

- 2 Touch the title area and enter a folder name using the keyboard.
- 3 Touch **Done** on the keyboard.
- 4 Touch anywhere on the Home screen to close the folder. The folder name appears under the folder.

Figure 43: Renamed Folder

Removing a Folder

Procedure:

- 1 Touch and hold the folder icon until it enlarges.
- 2 Drag the icon to **X Remove** and release.

Changing the Home Screen Wallpaper



Note: Use of Live Wallpaper may reduce battery life.

Procedure:

- 1 Touch **≡**.
- 2 Touch **Wallpaper**.
- 3 From the **Choose wallpaper from** menu, touch **Gallery**, **Live wallpapers** or **Wallpapers**.
 - **Gallery** - Select to use an image stored on the device.
 - **Live wallpapers** - Select to use an animated wallpaper image.
 - **Wallpapers** - Select to use a wallpaper image.
- 4 Touch **Save** or **Set wallpaper**.

Using the Touchscreen

Use the multi-tap sensitive screen to operate the device.

- **Tap** - Tap to:
 - select items on the screen
 - type letters and symbols using the on-screen keyboard
 - press on-screen buttons.
- **Tap and Hold** - Tap and hold:
 - an item on the Home screen to move it to a new location or to the trash.
 - an item in Apps to create a shortcut on the Home screen.

- the Home screen to open a menu for customizing the Home screen.
- an empty area on the Home screen until the menu appears.
- **Drag** - Tap and hold an item for a moment and then move finger on the screen until reaching the new position.
- **Swipe** - Move finger up and down or left and right on the screen to:
 - unlock the screen
 - view additional Home screens
 - view additional application icons in the Launcher window
 - view more information on an application's screen.
- **Double-tap** - Tap twice on a web page, map, or other screen to zoom in and out.
- **Pinch** - In some applications, zoom in and out by placing two fingers on the screen and pinching them together (to zoom out) or spreading them apart (to zoom in).

Using the On-screen Keyboard

Use the on-screen keyboard to enter text in a text field. To configure the keyboard settings, touch and hold 



(comma) >  and then select **Android keyboard settings**.

Editing Text

Edit entered text and use menu commands to cut, copy, and paste text within or across applications. Some applications do not support editing some or all of the text they display; others may offer their own way to select text.

Entering Numbers, Symbols and Special Characters

To enter numbers and symbols:

- Touch and hold one of the top-row keys until a menu appears then select a number. Keys with alternate characters display an ellipsis (...) below the character.
- Touch and hold the Shift key with one finger, touch one or more capital letters or symbols to enter them, and then lift both fingers to return to the lowercase keyboard.
- Touch  to switch to the numbers and symbols keyboard.
- Touch the  key on the numbers and symbols keyboard to view additional symbols.

To enter special characters, touch and hold a number or symbol key to open a menu of additional symbols.

- A larger version of the key displays briefly over the keyboard.
- Keys with alternate characters display an ellipsis (...) below the character.

Applications

The **APPS** screen displays icons for all installed applications. [Table 8: Applications on page 56](#) lists the applications installed on the TC55. Refer to the *TC55 Integrator Guide* for information on installing and uninstalling application.



Note: The list of applications and application icons in the below table may vary depending upon the device configuration.

Table 8: Applications

Icon	Description
	<p>App Gallery - Provides links to utilities and demonstration applications that can be installed on the TC55.</p>
	<p>Bluetooth Pairing Utility – Use to pair the RS507 Hans-free Imager with the TC55 by scanning a bar code.</p>
	<p>Browser - Use to access the Internet or intranet. TC55 Professional Configuration only.</p>
	<p>Calculator - Provides the basic and scientific arithmetic functions.</p>
	<p>Calendar - Use to manage events and appointments.</p>
	<p>Camera - Take photos or record videos</p>
	<p>Contacts - Use to manage contact information. JellyBean OS only.</p>
	<p>Chrome - Use to access the Internet or intranet. TC55 Standard Configuration only.</p>
	<p>Clock - Use to set an alarm, stopwatch or timer.</p>
	<p>DataWedge - Enables data capture using the camera or optional scanner.</p>
	<p>Downloads - lists all downloads files.</p>
	<p>Drive - Upload photos, videos, documents, and other files to personal storage site. TC55 Standard Configuration only.</p>
	<p>DWDemo - Provides a way to demonstrate the data capture features using the Linear Imager or Camera. See DataWedge Demonstration on page 103 for more information.</p>

Table continued...











Icon	Description
	elemez — Use to provide diagnostic information to Zebra. See Elemez on page 106 for more information.
	Email - Use to send and receive email.
	File Browser - Organize and manage files on the TC55. See File Browser on page 79 for more information.
	Gallery - Use to view photos stored on the microSD card. For more information, see Gallery on page 96 for more information.
 or 	Gmail - Use to send and receive email using a Google email account. TC55 Standard Configuration only.
	Google - Launches Google search application. TC55 Standard Configuration only.
 or 	Google Settings - Use to connect applications to Google account, setup Google Plus account, set location settings, set search features and configure Android Device Manager. TC55 Standard Configuration only.
	Google+ - Connect with people on Google social network. TC55 Standard Configuration only.
	Hangouts - Use to communicate with friends using text messages and photos. TC55 Standard Configuration only.
	Maps - Use to see you location on a map (with public transit, traffic or satellite overlays). Search for any business or place of interest. Provides turn-by-turn navigation with voice guidance and traffic-avoidance and alternate routes, for drivers, cyclist, walkers and users of public transportation. TC55 Standard Configuration only.
	Messenger - Send messages to friends. TC55 JellyBean Standard Configuration only.
	Messaging - Send SMS and MMS messages. Messaging on page 80 for more information.
	MLog Manager - Use to capture log files for diagnostics. See MLog Manager on page 107 for more information.
	Mobi Control Stage – Opens the Mobi Control Stage application to stage the TC55.

Table continued...

Icon	Description
	Movie Studio - Create movie videos. See Movie Studio on page 103 for more information.
	MSP Agent - Enables management of the TC55 from an MSP server. Requires the purchase of an appropriate MSP client license per device to suit the level of management functionality required.
	Music - Play music stored on the microSD card. TC55 Professional Configuration only.
	News & Weather - Displays current news and weather. TC55 with JellyBean Standard Configuration only.
	People - Use to manage contact information. People on page 82 for more information (KitKat only).
	Phone - Use to make phone calls. Calls on page 67 for more information. TC55AH and TC55BH only.
	Photos - Use to sync photos with Google account. TC55 with KitKat Standard Configuration only.
	Play Books - Use to read books. TC55 Standard Configuration only.
	Play Games - Use to play games. TC55 Standard Configuration only.
	Play Magazines - Use to subscribe to magazine and read on-line. TC55 Standard Configuration only.
	Play Movies & TV - View movies and video on your device. TC55 Standard Configuration only.
	Play Music - Use to listen to music. TC55 Standard Configuration only.
	Play Newsstand - Displays current news TC55 KitKat Standard Configuration only.
	Play Store - Download music, movies, books, and Android apps and games from the Google Play Store. TC55 Standard Configuration only.

Table continued...

















Icon	Description
	Rapid Deployment - Allows the TC55 to stage a device for initial use by initiating the deployment of settings, firmware and software. Requires the purchase of an MSP client license per device.
	RxLogger - Use to diagnose device and application issues. See the <i>TC55 Integrator Guide</i> for more information.
	Scan mode - Use to configure the TC55 buttons to initiate scanning. TC55 with 2D imager only.
	Search - Use the Google search engine to search the Internet and the TC55. TC55 Professional Configuration only.
 or 	Settings - Use to configure the TC55.
	SimulScan Demo - Use to demonstrate the document capture feature of the TC55. KitKat OS only.
	Sound Recorder - Use to record audio.
	StageNow Client - Allows the TC55 to stage a device for initial use by initiating the deployment of settings, firmware and software. KitKat OS only.
	TechDocs - Displays the On-device User Guide.
	Voice Dialer - Use to place calls by speaking. TC55AH and TC55BH only.
	Voice Search - Use to perform searches by asking questions. TC55 Standard Configuration only.
 or 	YouTube - Use to view videos on the YouTube web site. TC55 Standard Configuration only.
	AppLock Administrator - Use to configure the Application Lock feature. This icon appears after the optional applications is installed.
	MultiUser Administrator - Use to configure the MultiUser feature. This icon appears after the optional applications is installed.

Table continued...

Icon	Description
	Secure Storage Administrator - Use to configure the Secure Storage feature. This icon appears after the optional applications is installed.

Accessing Applications

All applications installed on the device are accessed using the **APPS** window.

Procedure:

- 1 Touch .

Figure 44: APPS Window Example

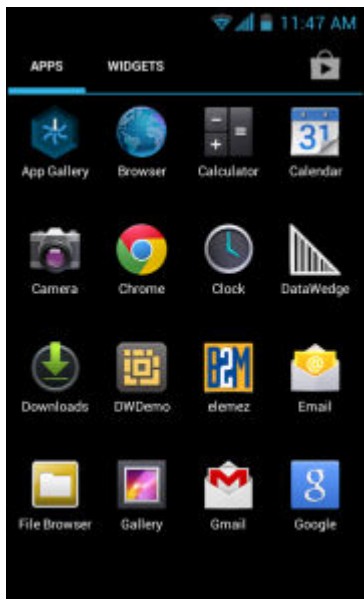

- 2 Slide the **APPS** window left or right to view more application icons. Touch an icon to open the application.



Note: See [Application Shortcuts and Widgets on page 53](#) for information on creating a shortcut on the Home screen.

- 3 On TC55 with GMS, touch  to access the Google Play Store to purchase, download and install new applications.

Switching Between Recent Applications

Procedure:





- 1 On TC55 non-GMS JellyBean, touch and hold .
- 2 On TC55 non-GMS KitKat, touch and hold .
- 3 On TC55 with GMS, touch and hold .
- 4 A window appears on the screen with icons of recently used applications.

Figure 45: Recently Used Applications

- 5 Slide the window up and down to view all recently used applications.
- 6 Swipe left or right to remove application from the list and force close the application.
- 7 Touch an icon to open it or touch  to return to the current screen.

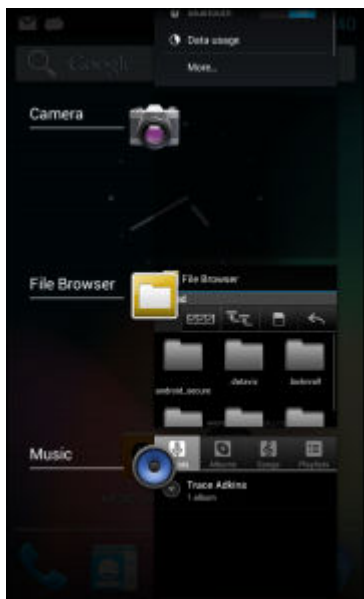

Un-Locking the Screen

Use the Lock screen to protect access to data on the TC55. Some email account require locking the screen. Refer to the *TC55 Integrator Guide* for information on setting up the locking feature. The Locking feature functions differently in Single User mode or Multiple User mode.

Single User Mode

When locked, a pattern, PIN or password is required to unlock the device. Press the Power button to lock the screen. The device also locks after a pre-defined time-out.

Press and release the Power button to wake the device.

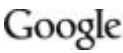
The Lock screen displays. Slide  to the right toward  to unlock the screen. On TC55 with GMS, slide up toward  to open the Google search application.

If the Pattern screen unlock feature is enabled, the Pattern screen appears instead of the Lock screen.

If the PIN or Password screen unlock feature is enabled, enter the PIN or password after unlocking the screen.

Figure 46: Lock Screen



Figure 47: PIN Screen

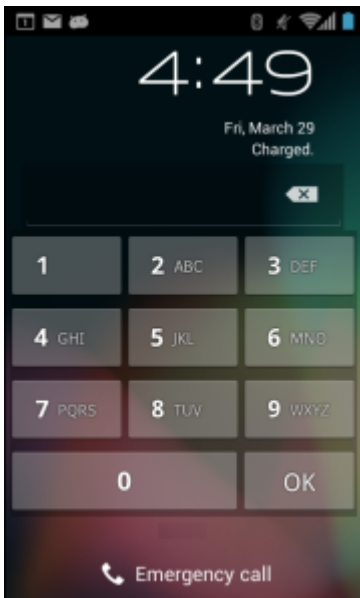
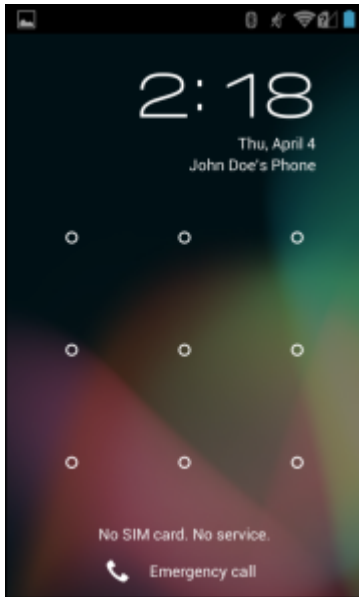
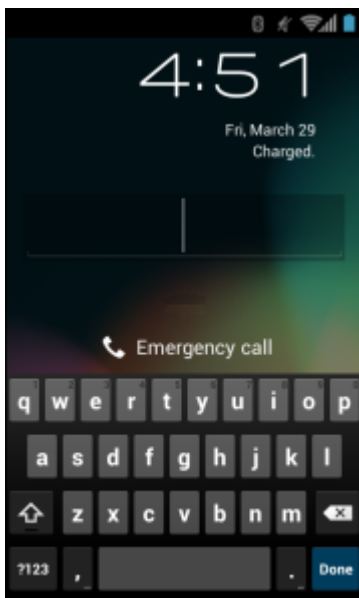

Figure 48: Pattern Screen**Figure 49: Password Screen**

MultiUser Mode

With MultiUser login, multiple users can log on to the device with each user having access to various applications and features. When enabled, the Login screen appears after powering on, resetting or after the device wakes from suspend mode.

MultiUser Login

Procedure:

- 1 In the **Login** text field, enter the username.

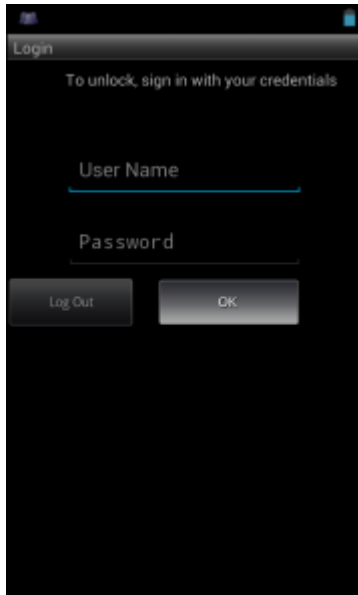
Figure 50: Multiple User Log In Screen

- 2 In the **Password** text field, enter the password.
- 3 Touch **OK**. After a resume from suspend, the user must enter the password.

MultiUser Logout

Procedure:

- 1 Drag the Status Bar down from the top of the screen.
- 2 Touch **MultiUser is active**.
- 3 Touch **Logout**.
- 4 The **Login** screen appears.

Resetting the Device

There are two reset functions, soft reset and hard reset.

Performing a Soft Reset

Perform a soft reset if applications stop responding.

Procedure:

- 1 Press and hold the Power button until the menu appears.
- 2 Touch **Reset**.
- 3 The device reboots.

Performing a Hard Reset



Caution: Performing a hard reset with a SD card installed in the TC55 may cause damage or data corruption to the SD card.

Perform a hard reset if the TC55 stops responding.

Procedure:

- 1 Simultaneously press the Power, Programmable and Volume Up buttons.

Figure 51: Three Button Reset

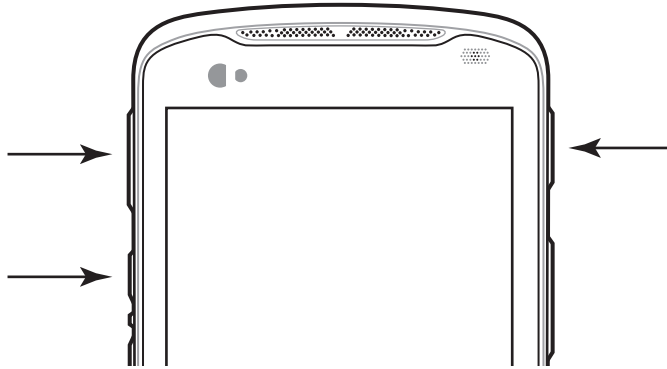



- 2 The TC55 reboots.

Suspend Mode

The TC55 goes into suspend mode when the user presses the Power button or after a period of inactivity (set in the Display settings window).

To wake the TC55 from Suspend mode, press the Power button.

The Lock screen displays. Slide  to the right toward  to unlock the screen. If the Pattern screen unlock feature is enabled, the Pattern screen appears instead of the Lock screen. See Un-Locking the Screen.



Note:

If the user enters the PIN, password or pattern incorrectly five times, they must wait 30 seconds before trying again.

If the user forgets the PIN, password or pattern contact the system administrator.

Figure 52: Lock Screen

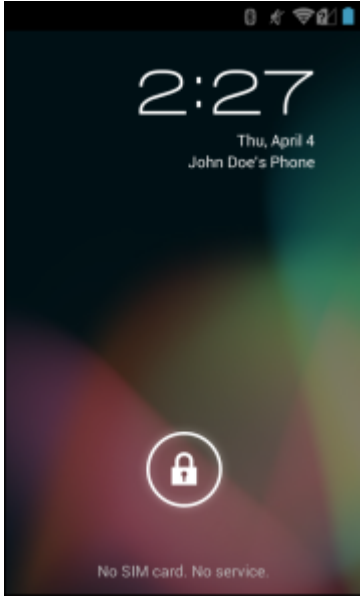

Chapter

3

Calls



Note: Making phone calls is not available on TC55CH with LTE Data Only configurations.

Make a phone call from the **Phone** application, the **People** application or other applications or widgets that display contact information.

Emergency Calling

The service provider programs one or more emergency phone numbers, such as 911 or 999, that the user can call under any circumstances, even when the phone is locked, a SIM card is not inserted or the phone is not activated. The service provider can program additional emergency numbers into the SIM card. However, the SIM card must be inserted in the device in order to use the numbers stored on it. See the service provider for additional information.



Note: Emergency numbers vary by country. The phone's pre-programmed emergency number(s) may not work in all locations, and sometimes an emergency call cannot be placed due to network, environmental, or interference issues.

Audio Modes

The device offers three audio modes for use during phone calls:

- **Handset Mode:** Switches audio to the receiver at the top front of the device, so the user can use the device as a handset. This is the default mode.
- **Speaker Mode:** Use the device as if on speaker phone.
- **Headset Mode:** Connect a Bluetooth or wired headset to automatically switch audio to the headset.

Using a Bluetooth Headset

Use a Bluetooth headset for audio communication when using an audio-enabled application. See [Bluetooth on page 139](#) for information on connecting a Bluetooth headset to the device. Set the volume appropriately before putting on the headset. When a Bluetooth headset is connected, the speakerphone is muted.

Using a Wired Headset

Use a wired headset (with 3.5 mm plug) for audio communication when using an audio-enabled application. Set the volume appropriately before putting on the headset. When a wired headset is connected, the speakerphone is muted.

Lift the headset cover and insert the headset plug.

To end a call using the wired headset, press and hold the headset button until the call ends.

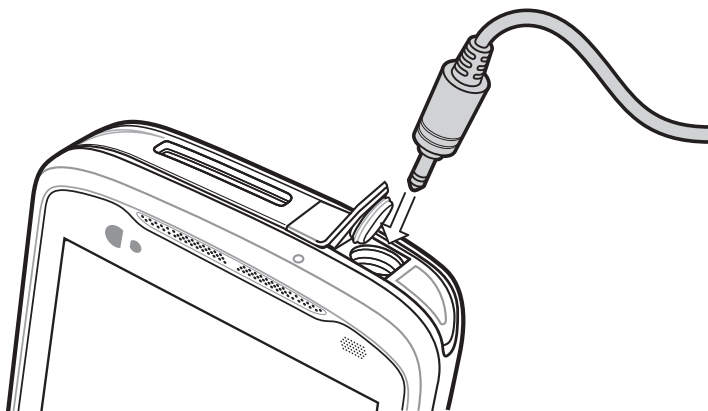
Figure 53: Insert Wired Headset Plug

Adjusting Audio Volume

Use the Volume buttons to adjust the volume of the ringer when not in a call and the audio volume when in a call.



Note: Adjust the conversation phone volume during a call. Adjusting the volume while not in a call affects the ring and notification sound levels.

Making a Call Using the Dialer

Use the dialer tab to dial phone numbers.

Procedure:

- 1 On the Home screen touch .

Figure 54: Dialer Screen (JellyBean)

Figure 55: Dialer Screen (KitKat)







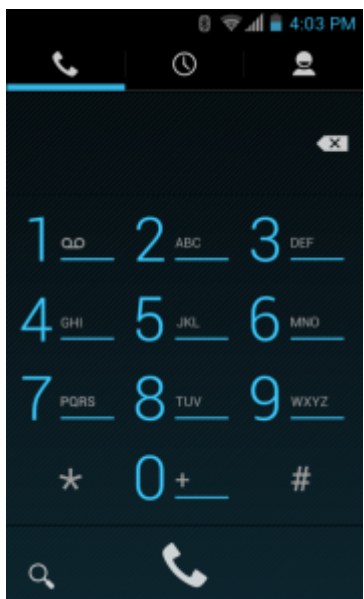
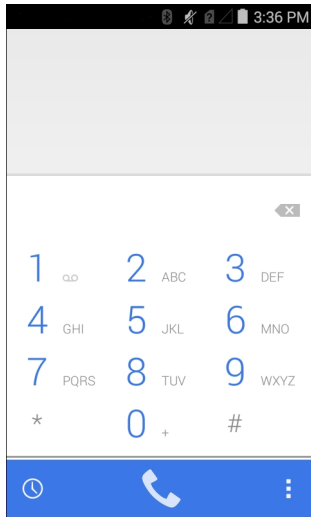





- 2  Touch the  tab above the dialer.
- 3 Touch the keys to enter the phone number.
- 4  Touch  below the dialer to initiate the call.

Figure 56: Call in Progress

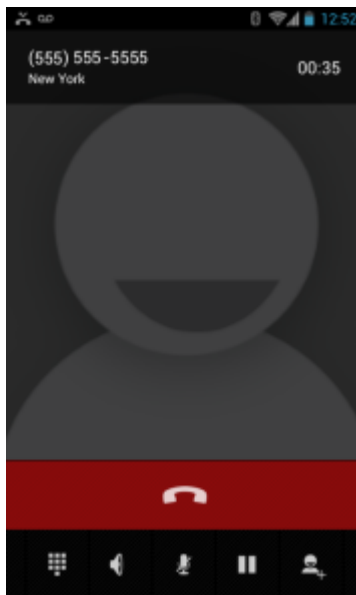



If...	Then...
You want to display the dialer.	Touch  .
You want to turn on the speakerphone.	Touch  .

If...	Then...
You want to mute the call.	Touch  .
You want to place the call on hold.	Touch  .
You want to add another person to the call.	Touch  .

5 Touch  to end the call.

Dialer Dialing Options

The dialer provides options to save the dialed number to contacts, insert pauses and wait into the dial string and options for setting the Call settings. Enter at least one digit to access these options. Touch  or  to access the following.

- **Add to contacts** – add the dialed number to the **People** application.
- **Add 2–sec pause** - pause the dialing of the next number for two seconds. Multiple pauses can be added sequentially.
- **Add wait** - wait for confirmation to send the rest of the digits.
- **Settings** - Opens the **Call settings** screen.

Making a Call Using Contacts

Procedure:





- 1 On the Home screen touch .
- 2 Touch the  tab.

Figure 57: Dialer Contacts Tab



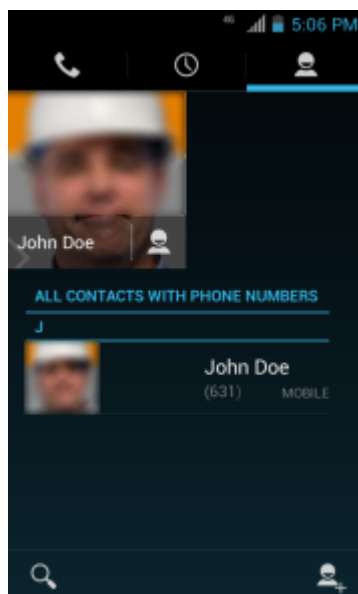

3 Touch the contact to initiate the call.

4  Touch  to end the call.

Making a Call Using Call History

Call History is a list of all the calls placed, received, or missed. It provides a convenient way to redial a number, return a call, or add a number to Contacts.

Arrow icons beside a call indicate the type of call. Multiple arrows indicate multiple calls:

-  - Missed incoming call
-  - Received incoming call
-  - Outgoing call.



Procedure:

1 On the Home screen touch .

2 Touch the  tab.

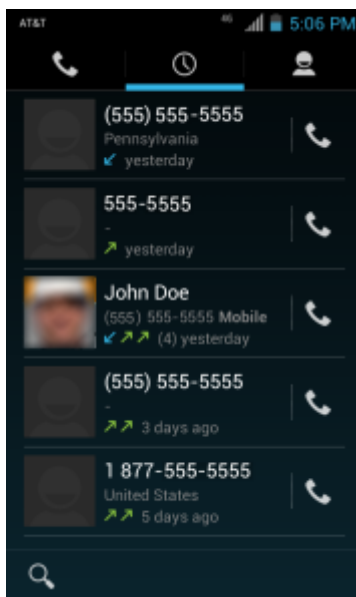
Figure 58: Call History Tab



3  Touch  next to the contact to initiate the call.

4  Touch  to end the call.

Making a Conference Call

To create a conference phone session with multiple people.



Note: Conference Calling and the number of conference calls allowed may not be available on all services. Please check with the service provider for Conference Calling availability.

Procedure:





- 1 On the Home screen touch .
- 2 Touch the  tab above the dialer.
- 3 Touch the keys to enter the phone number.
- 4 Touch  below the dialer to initiate the call.
- 5 When the call connects, touch . The first call is placed on hold.
- 6 Touch the keys to enter the second phone number.
- 7 Touch  below the dialer to initiate the call.
- 8 When the call connects, the first call is placed on hold and the second call is active.

Figure 59: Two Calls



- 9 Touch  icon to create a conference call with three people.

Figure 60: Merged Calls

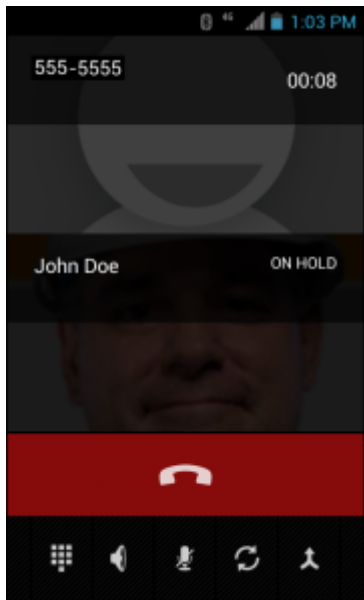



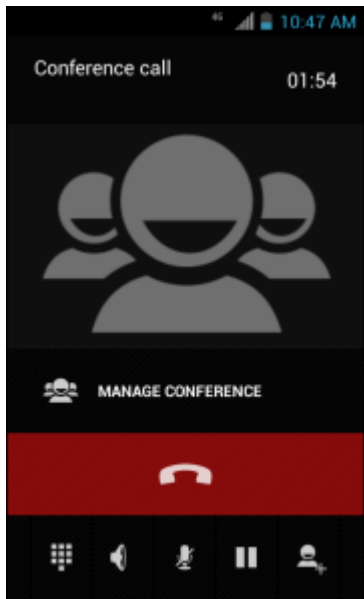

- 10 Touch  to add another call.
The conference is placed on hold.
- 11 Touch the keys to enter the second phone number.
- 12 Touch  below the dialer to initiate the call.
- 13 Touch  icon to add the third call to the conference.
- 14 Touch **Manage Conference** to view all callers.

Figure 61: Un-merge Calls



- 15 To remove a caller from the conference, touch  next to the caller.

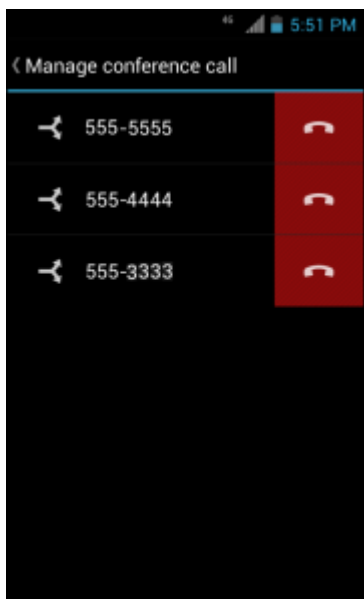

Note: To speak privately with one party during a conference call, touch **Manage Conference** and then touch the caller. To include all parties again, touch .

Making a Call Using a Bluetooth Headset

Procedure:

- 1 Pair the Bluetooth headset with the device.
- 2 Press the Call button on the Bluetooth headset.
“Speak now” is heard from the Bluetooth headset and the **Voice Dialer** screen appears.
- 3 Say a command.

If...	Then...
You want to call a contact by name:	Say “Call <i>(name)</i> .”
You want to call a number:	Say “Dial <i>(number)</i> .”
If you want to call your voicemail:	Say “Call voicemail.”
If you want to call the previous caller:	Say “Redial.”

- 4 Press the Call button on the Bluetooth headset to end the call.

Answering Calls

When you receive a phone call, the **Incoming Call** screen opens, displaying the caller ID and any additional information about the caller that is in the **People** application.

Figure 62: Incoming Call Screen

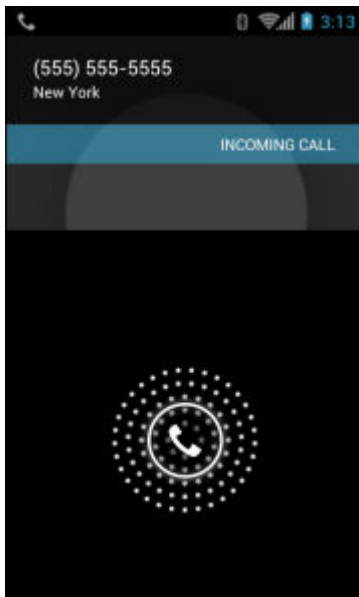



All incoming calls are recorded in the **Phone** application Call log tab. If you miss a call, you receive a notification. To silence the ringer before answering the call, press the volume down button on the side of device.

When a call arrives, touch the white phone icon and slide over one of these icons:

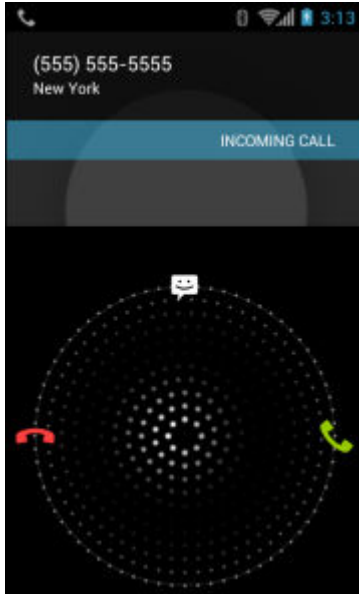
Figure 63: Select Answer Options



-  Answer call - Start talking to the caller.
-  Send to voice mail - Direct the caller to leave a voice mail message.
-  Send a message - Opens a list of quick text responses. Touch one to send it to the caller immediately.

Answering Calls with a Bluetooth Headset

When you receive a phone call, the **Incoming Call** screen opens, displaying the caller ID and any additional information about the caller that is in the **People** application.

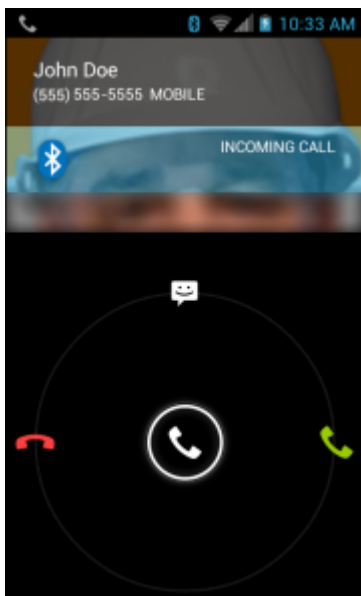
Figure 64: Incoming Call Screen

All incoming calls are recorded in the **Phone** application Call log tab. If you miss a call, you receive a notification. To silence the ringer before answering the call, press the volume down button on the side of the device.

When a call arrives, touch the Call button on the Bluetooth headset to answer the call..

To end the call press the Call button on the Bluetooth headset.

Call Settings



Note: Not all options are available for all configurations.

Use the Call Settings to modify options related to the phone call feature.

- **Ringtone**
 - **Phone ringtone** - Touch to select a ringtone to sound when an incoming call is received.
 - **Vibrate when ringing** - Check to make the device vibrate when a call is received.
- **Other Call Settings**
 - **Ringtone Settings** - When using a Bluetooth headset, select the path that the ring is heard. Options: **Bluetooth** or **Speaker and Bluetooth** (default). Note: Bluetooth headset connection is required to set this option.
 - **Voicemail** - Touch to configure voicemail settings.
 - + **Service** - Set the service provider or other provider for voicemail service.
 - + **Setup** - Touch to update the phone number used to access voicemail.
 - + **Ringtone** - Touch to select a ringtone to sound when a voicemail is received.
 - + **Vibrate** - Touch to select vibrate option. Options: **Always, Only when silent** or **Never** (default).
 - **Text message service center** - Touch to update the phone number used to access text messages.
 - **Dial pad touch tones** - Check to play a sound when a phone key is touched.
 - **Quick responses** - Touch to edit quick responses to use instead of answering a call.
 - **Fixed Dialing Numbers** - Use Fixed Dialing to restrict the phone to dial only the phone number(s) or area code(s) specified in a Fixed Dialing list.

- **TTY/HAC mode** - Touch to set the TTY/HAC setting. Use an optional teletypewriter (TTY) device with the TC55 to send and receive calls. Plug the TTY device into the TC55 headset jack and set the TC55 to operate in one of the TTY modes (TC55AH and TC55BH only).



Note:

Use a TSB-121 compliant cable (provided by the TTY manufacturer) to connect the TTY device to the TC55.

Set the TC55 volume to a middle level setting for proper operation. If you experience a high number of incorrect characters, adjust the volume as needed to minimize the error rate.

For optimal performance, the TC55 should be at least 30 cm (12 inches) from the TTY device. Placing the TC55 too close to the TTY device may cause high error rates.

- + **TTY/HAC off** (default) - TTY and HAC is off.
- + **TTY Full** - Transmit and receive TTY characters.
- + **TTY HCO** - Transmit TTY characters but receive by listening to earpiece.
- + **TTY VCO** - Receive TTY characters but transmit by speaking into microphone.
- + **HAC On** - Turn Hearing Aide Compatibility (HAC) on. The  icon appears in the Status bar.
- **TTY mode** - Touch to set the TTY setting. Use an optional teletypewriter (TTY) device with the TC55 to send and receive calls. Plug the TTY device into the TC55 headset jack and set the TC55 to operate in one of the TTY modes (TC55CH only).



Note:

Use a TSB-121 compliant cable (provided by the TTY manufacturer) to connect the TTY device to the TC55.

Set the TC55 volume to a middle level setting for proper operation. If you experience a high number of incorrect characters, adjust the volume as needed to minimize the error rate.

For optimal performance, the TC55 should be at least 30 cm (12 inches) from the TTY device. Placing the TC55 too close to the TTY device may cause high error rates.

- + **TTY off** (default) - TTY is off.
- + **TTY Full** - Transmit and receive TTY characters.
- + **TTY HCO** - Transmit TTY characters but receive by listening to earpiece.
- + **TTY VCO** - Receive TTY characters but transmit by speaking into microphone.
- **Hearing aids** - Turn Hearing Aide Compatibility (HAC) on. The  icon appears on the Status bar (TC55CH only).
- **DTMF tones** - Touch to set the length of the DTMF tones. Options: **Normal** (default) or **Long**.
- **GSM call settings** - (TC55AH and TC55BH only)
 - + **Call forwarding** - Use call forwarding to forward incoming calls to a different phone number.



Note: Call Forwarding may not be available on all networks. Check with the service provider for availability.

- **Always forward** - set to forward all calls to a different phone number.
- **Forward when busy** - enter the phone number to forward calls only when the line is busy.
- **Forward when unanswered** - enter the phone number to forward calls only when the phone cannot be answered.
- **Forward when unreachable** - enter the phone number to forward calls only when the phone is turned off or the user is unreachable.
- + **Call barring** - Use call barring to block certain types of incoming and/or outgoing calls. Select the type of incoming and/or outgoing calls to block.
- + **Additional settings**

- **Caller ID** - Enable caller ID to reveal the identity of the person making an outgoing call. Options: **Network default** (default), **Hide number**, **Show number**.
- **Call waiting** - Check to enable.
- **CDMA call settings** (TC55CH only)
 - **Voice privacy** – Enable enhanced privacy mode.
- **Internet Call Settings**
 - **Accounts** - Choose to receive Internet calls for accounts added to the device, view or change SIP accounts, or add an Internet calling account.
 - **Use Internet calling** - Use Internet calling for all calls, only for calls to Internet calling addresses (the default setting), or to ask for each call. Must be connected to a Wi-Fi network and have added an Internet calling account to the device to use Internet calling.

Chapter 4

Applications

This section describes the applications installed on the device.

File Browser

Use the **File Browser** application to view and manage files on the device.





To open **File Browser**, touch  > .

Figure 65: File Browser Screen



The address bar (1) indicates the current folder path. Touch the current folder path to manually enter a path and folder name.

Use  (2) to select multiple files/folder.

Use  (3) to view the internal storage root folder.







Use  (4) to view the microSD card root folder.

Use  (5) to view the previous folder or to exit the application.

Touch and hold an item to perform an operation on that item. Select one of the options from the **File Operations** menu:

- **Information** - View detailed information about the file or folder.
- **Move** - Move the file or folder to a new location.
- **Copy** - Copy the select file.
- **Delete** - Delete the selected file.
- **Rename** - Rename the select file.
- **Open as** - Open the selected file as a specific file type.
- **Share** - Share the file with other devices.

Touch  to open additional functionality:

- Touch  > **New Folder** to create a new folder in the current folder.
- Touch  > **Search** to search for a file or folder.
- Touch  > **Sort** to sort the list by name, by type, by size or by date.
- Touch  > **Refresh** to re-display the contents of the current folder.
- Touch  > **List View** to change the folder view from tile to list format.
- Touch  > **Change Size** to change the size of the icons: Large, Normal or Small.
- Touch  > **About File Browser** to view the application version information.

Messaging

Use **Messaging** to send and receive SMS and MMS messages. From a Home or All Apps screen, touch .

Sending a Text Message

Procedure:

1

In the main **Messaging** screen, touch .

Figure 66: New Text Message Screen



2 In the **To** field, enter a name or a mobile phone number.

3 In the **Type message** field, enter the text message.

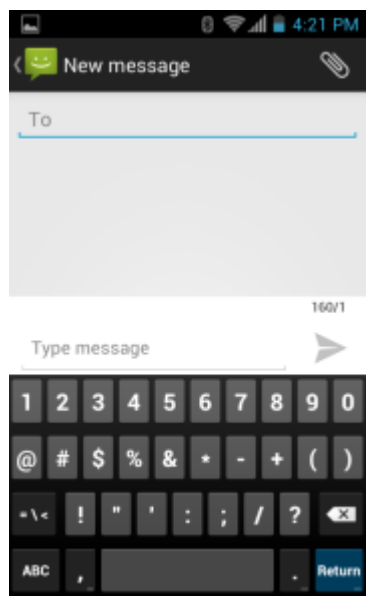
The 160-character limit counter indicates how many characters are left. If it goes over that limit, a new message is created, which is joined with its predecessors when received.

If the user presses the Back button while composing a message, it's saved as a draft in the **Messaging** screen. Touch the conversation to resume composing it.

4 Touch  to send the message.

Sending a Multimedia Message

Procedure:

1 In the main **Messaging** screen, touch .

Figure 67: New Multimedia Message Screen

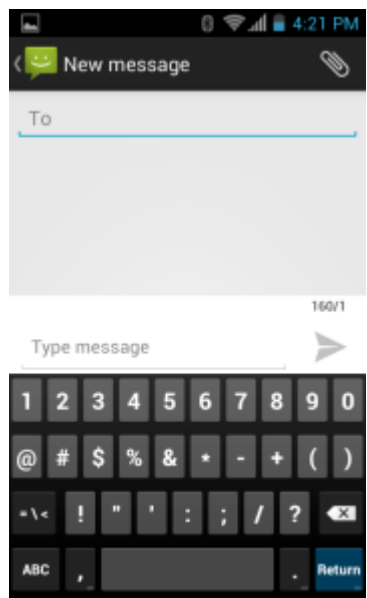

2 In the **To** field, enter a name or a mobile phone number.

3 Touch  to attach the media file of your choice:

- **Pictures.** Select a picture to attach.
- **Capture picture.** Camera opens to take a picture and attach it.
- **Videos.** Select a video to attach.
- **Capture video.** Camcorder opens to record a video and attach it to the message.
- **Audio.** Choose a sound file to attach.
- **Record audio.** Sound Recorder opens to record a spoken message and attach it to the message.
- **Slideshow.** Opens a screen opens to assemble text, photos, videos, and recordings into a slideshow of up to 10 slides to attach to the message.
- **vCard.** Send a contact's information.

4 Touch  to send the message.

People

Use the **People** application to manage contacts.

From a Home or **Apps** screen, touch . **People** opens to the main list of contacts. View contacts in three ways at the top of the screen: **Groups**, **All contacts**, and **Favorites**. Touch the tabs to change how to view the contacts. Swipe up or down to scroll through the lists.



Adding People

Procedure:

- 1 In the **People** application, touch .
- 2 If there are more than one account with contacts, touch the one to use.
- 3 Type the contact's name and other information. Touch a field to start typing, and swipe down to view all categories.
- 4 To add more than one entry for a category – for example, to add a work address after typing a personal address – touch **Add new** for that field. To open a menu with preset labels, such as **Home** or **Work** for an email address, touch the label to the right of the item of contact information. Or, to create your own label, touch **Custom** in the menu.
- 5 Touch **Done**.



Editing People

Procedure:

- 1 In the **People** application, touch  tab.
- 2 Touch a person to edit.
- 3 Touch .
- 4 Touch **Edit**.
- 5 Edit the contact information.
- 6 Touch **Done**.

Deleting People

Procedure:

- 1 In the **People** application, touch  tab.
- 2 Touch a person to edit.
- 3 Touch .
- 4 Touch **Delete**.
- 5 Touch **OK** to confirm.

Voice Dialer

Voice Dialer is a speech dialog system that provides natural human interface for users to communicate seamlessly with the device. Users can make phone calls, look up contact information, launch programs or check calendars.

To initiate **Voice Dialer** tap **Voice Dialer** or press the call button on a Bluetooth headset.

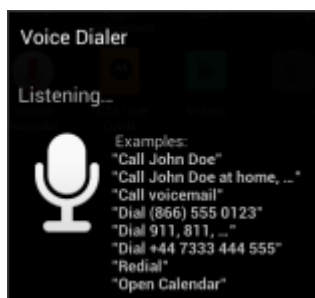
Figure 68: Voice Dialer Window

The user says one of the following commands:

- Call
- Dial
- Redial
- Open.

Calling a Person By Name

Procedure:

- 1 Launch **Voice Dialer**.
- 2 Say “Call John Doe.”
- 3 In the **Voice Dialer** dialog box, touch **Call John Doe**
The call is initiated.

Redialing Previous Call

Procedure:

- 1 Launch **Voice Dialer**.
- 2 Say “Redial.”
- 3 In the **Voice Dialer** dialog box, touch **Redial**
The call is initiated.

Dialing By Number

Procedure:

- 1 Launch **Voice Dialer**.
- 2 Say “Dial (phone number).”



Note: Be careful not to say the number too fast or the application might not recognize what you are saying.

- 3 In the **Voice Dialer** dialog box, touch the number that appears.
The call is initiated.

Opening an Application

Procedure:

- 1 Launch **Voice Dialer**.
- 2 Say “Open (*application name*).”

- 3 In the **Voice Dialer** dialog box, touch the application name.
The application opens.

Camera (JellyBean)

This section provides information for taking photos and recording videos using the integrated digital cameras.



Note: If a microSD card is installed, The TC55 saves photos and videos on the microSD card. If a microSD card is not installed, the TC55 saves photos and videos on the internal storage.

Taking Photos



Note:

Camera settings are described in [Camera Settings on page 87](#).

To take a photo:

Procedure:

- 1 Touch .
- 2 Touch .

Figure 69: Camera Mode

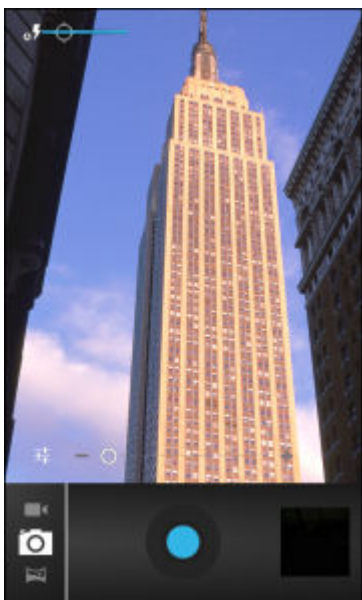



- 3 If necessary, touch the options bar and touch .
- 4 Touch to adjust exposure, flash, and other settings using the camera settings. See [Camera Settings on page 87](#) for more information.
- 5 Touch and to adjust the zoom level.
- 6 Frame the subject on screen.

7  Touch .

The camera brings the image into focus. When the image is in focus, the focus indicators in each corner turn green, the camera takes a photo and a shutter sound plays.



Note: To disable the shutter sound, turn notification sounds off. Touch  >  **Sounds > Volumes** and slide the **Notifications** slider all the way to the left.

Alternately, touch  and hold to focus first, before taking a photo; then release to take a focused photo.

The photo appears momentarily then displays as a thumbnail in the upper right corner.

8 Touch the thumbnail to view the photo in **Gallery**. See [Gallery on page 96](#) for more information.

Taking a Panoramic Photo

Panorama mode lets the user create a single wide image by panning slowly across a scene.

Procedure:

1 Touch .

2 Touch .



3 Touch the options bar and touch .



Figure 70: Panoramic Mode



4 Frame one side of the scene to capture.

5 Touch  and slowly start panning across the area to capture. A small white square appears inside the button the shot is in progress.

If panning too quickly, the message **Too fast** appears.

- 6  Touch  to end the shot. The panorama appears immediately and a progress indicator displays while it saves the image.
- 7 Touch the thumbnail to view the photo in **Gallery**. See [Gallery on page 96](#).

Recording Videos







To record a video:

Procedure:

- 1 Touch  > .
- 2 Touch the options bar and touch .

Figure 71: Video Mode















- 3 Touch  to adjust exposure, flash, and other settings using the video settings. See [Video Settings on page 87](#) for more information.
 - 4 Touch  and  to adjust the zoom level.
 - 5 Point the camera and frame the scene.
 - 6 Touch  to start recording.
The device starts recording the video. The video time remaining appears in the top left of the screen.
 - 7 Touch  to end recording.
-  **Note:** Previously recorded video displays in the thumbnail at the top right.
- 8 Touch the thumbnail to access the **Gallery** application. See [Gallery on page 96](#).

Camera Settings

When in Camera mode, Camera settings are displayed on screen. Touch  for the settings to change.











Touch  to display the camera setting options.

-  **Settings** - Touch to open a scrolling list of settings:
 - **Store location** - Include location information with each photo using the device global positioning system (GPS). Options: **On** or **Off** (default).
 - **Picture size** - Touch to set the size (in pixels) of the photo. Options: **8M pixels** (default), **5M pixels**, **3.2M pixels**, **2M pixels**, **1M pixels**, **VGA** or **QVGA**.
 - **Picture quality** - Touch to select picture quality setting. Options: **Super fine** (default), **Fine** or **Normal**.
 - **Focus Mode** - Touch to select the camera focus setting. Options: **Continuous**, **Macro**, **Infinity** or **Auto** (default).
 - **Select ISO** - Set how sensitive the camera is to light. Options: **ISO Auto** (default), **ISO100**, **ISO200**, **ISO400**, **ISO800**.
 - **ZSL** - Set the camera to immediately take a picture when the button is pressed. Options: **On** or **Off** (default).
 - **Shutter sound** - Touch to set the sound that occurs when the user presses the camera button. Options: **On** or **Off** (default).
 - **Restore defaults** - Touch **Restore defaults** to restore all camera settings to the default values.
- **SCN Scene mode** - Touch to select a preset combination of camera settings designed for specific scenes. Options: **Auto** (default), **Night**, **Portrait**, **Landscape**, **Steady Photo** or **Sports**.
-  **Exposure** - Touch to adjust the exposure settings. Options: **+3**, **+2**, **+1**, **0** (default), **-1**, **-2**, or **-3**.
-  **White balance** - Touch to select how Camera adjusts colors in different kinds of light, to achieve the most natural-looking colors.
 -  **Auto** - Adjust the white balance automatically (default).
 -  **Incandescent** - Adjust the white balance for incandescent lighting.
 -  **Daylight** - Adjust the white balance for daylight.
 -  **Fluorescent** - Adjust the white balance for florescent lighting.
 -  **Cloudy** - Adjust the white balance for a cloudy environment.
-  **Flash mode** - Touch to set whether Rear-facing Camera relies on its light meter to decide whether a flash is necessary, or to turn it on or off for all shots.
 -  **Auto** - Camera adjusts flash automatically depending upon light meter.
 -  **On** - Enable flash upon taking a photo.
 -  **Off** - Disable flash (default).
 -  **Torch** - Turn flash on continuously.

Video Settings

When in Video mode, Video settings are displayed on screen. Touch  for the settings to change.

Touch  to display the video setting options.

-  **Settings** - Touch to open a scrolling list of settings:
 - **Store location** - Include location information with each photo using the device global positioning system (GPS). Options: **On** or **Off** (default).
 - **Restore defaults** - Touch **Restore defaults** to restore all video settings to the default values.
- **Video quality** - Touch to select video quality:
 - **HD 1080p** - High definition 1080p.
 - **HD 720p** - High definition 720p.
 - **SD 480p** - Standard definition 480p.
- **Time lapse interval** - Touch to select a time interval to set the frame rate for time lapse photography. Options: **Off** (default), **1s**, **1.5s**, **2s**, **2.5s**, **3s**, **5s** or **10s**.
-  **White balance** - Touch to select how Camera adjusts colors in different kinds of light, to achieve the most natural-looking colors.
 -  **Auto** - Adjust the white balance automatically (default).
 -  **Incandescent** - Adjust the white balance for incandescent lighting.
 -  **Daylight** - Adjust the white balance for daylight.
 -  **Fluorescent** - Adjust the white balance for florescent lighting.
 -  **Cloudy** - Adjust the white balance for a cloudy environment.
-  **Flash mode** - Touch to set whether Rear-facing Camera relies on its light meter to decide whether a flash is necessary, or to turn it on or off for all shots.
 -  **On** - Enable flash upon taking a photo.
 -  **Off** - Disable flash (default).

Camera (KitKat)

This section provides information for taking photos and recording videos using the integrated digital cameras.



Note: If a microSD card is installed, The TC55 saves photos and videos on the microSD card. If a microSD card is not installed, the TC55 saves photos and videos on the internal storage.

Figure 72: Camera Photo Screen

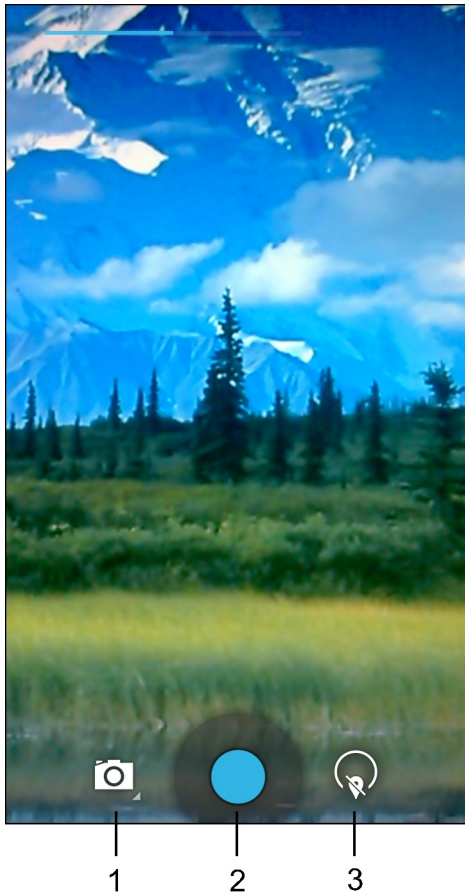

1	Camera Options — Touch to select Camera, Video or Panorama mode.
2	Shutter button - Touch to take a photo, a panoramic photo or to record a video.
3	Photo Settings – Touch to select camera settings.

Taking Photos



Note:

Camera settings are described in *TC55 Photo Settings on page 94*.

Procedure:

- 1 Touch .
- 2 Touch .

Figure 73: Camera Mode



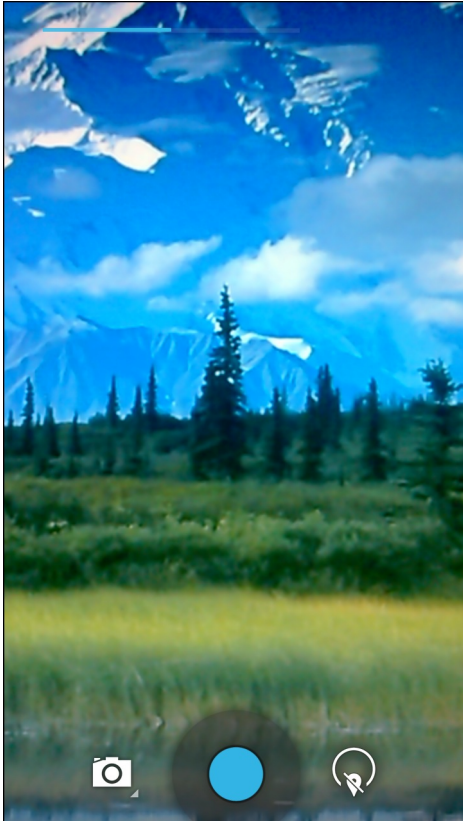

- 3 If necessary, touch the camera options icon and touch .
- 4 Frame the subject on the screen.
- 5 To zoom in or out, press two fingers on the display and pinch or expand fingers. The zoom controls appear on the screen.

Figure 74: Camera Zoom

- 6 Touch an area on the screen to focus. The focus circle appears on the screen. The two horizontal bars turn green when in focus.
- 7 Touch .

The camera takes a photo and a shutter sound plays.

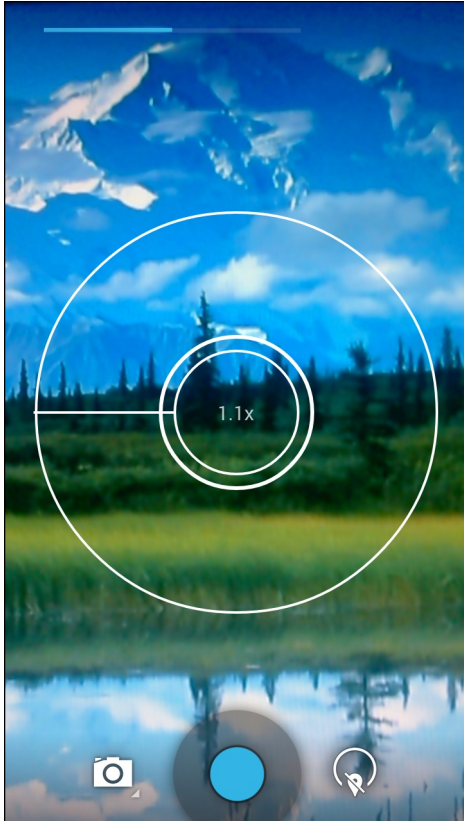
Alternately, touch  and hold to focus first, before taking a photo; then release to take a focused photo.

The photo momentarily displays as a thumbnail in the upper right corner.

Taking a Panoramic Photo

Panorama mode lets the user create a single wide image by panning slowly across a scene.

Procedure:





- 1 Touch .
- 2 Touch .

Figure 75: Panoramic Mode

- 3 Touch the options bar and touch .
- 4 Frame one side of the scene to capture.
- 5 Touch  and slowly start panning across the area to capture. A small white square appears inside the button indicating the capture is in progress.
If panning too quickly, the message **Too fast** appears.
- 6 Touch  to end the shot. The panorama appears immediately and a progress indicator displays while it saves the image.

Recording Videos

To record a video:

Procedure:



- 1 Touch .
- 2 Touch .

Figure 76: Video Mode



- 3 Touch the options bar and touch .
- 4 Point the camera and frame the scene.
- 5 To zoom in or out, press two fingers on the display and pinch or expand fingers. The zoom controls appear on the screen.

Figure 77: Camera Zoom

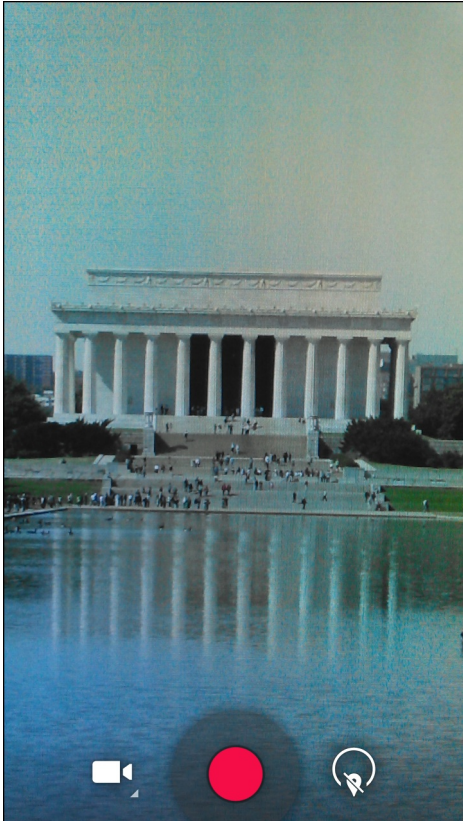
- 6 Touch  to start recording.

The device starts recording the video. The video time remaining appears in the top left of the screen.

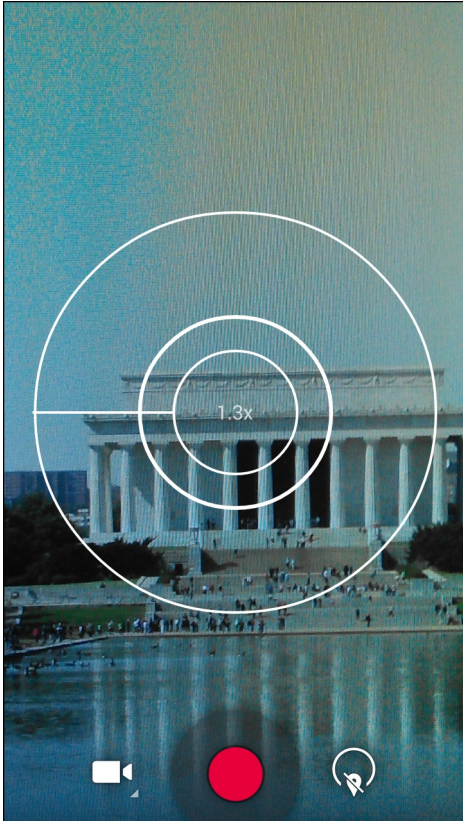
- 7 Touch  to end recording.

The video momentarily displays as a thumbnail in the upper right corner.

TC55 Photo Settings

When in Photo mode, photo settings are displayed on screen. Touch  to display the photo settings options.



Touch  to display the photo setting options.









Figure 78: Rear Photo Setting Options

- First :

- **Store location** - Set the camera to store the location the picture was taken as part of the image meta data (default – disabled).
- **Picture size** - Touch to set the size (in pixels) of the photo. Options: **8M pixels** (default), **5M pixels**, **3M pixels**, **2M pixels**, **1M pixels**, **VGA** or **QVGA**.
- **Picture quality** - Touch to select picture quality setting. Options: **Super fine** (default), **Fine** or **Normal**.
- **Select ISO** - Set how sensitive the camera is to light. Options: **Auto** (default), **ISO100**, **ISO200**, **ISO400** or **ISO800**.

- **ZSL** - Set the camera to immediately take a picture when the button is pressed (default – disabled).

• Second 

- **Scene mode** - Touch to select a preset combination of camera settings designed for specific scenes. Options: **Auto** (default), **Night**, **Portrait**, **Landscape**, **Steady Photo** or **Sports**.
- **Focus Mode** - Touch to select the camera focus setting. Options: **Auto** (default), **Infinity**, **Macro** or **CAF** (Continuous Auto Focus).
- **Flash mode** - Touch to set whether Rear-facing Camera relies on its light meter to decide whether a flash is necessary, or to turn it on or off for all shots.
 - +  **Off** - Disable flash.
 - +  **Auto** - Camera adjusts flash automatically depending upon light meter (default).
 - +  **On** - Enable flash upon taking a photo.
 - +  **Torch** - Turn flash on continuously.
- **Exposure** - Touch to adjust the exposure settings. Options: **+2**, **+1**, **0** (default), **-1** or **-2**.
- **White balance** - Touch to select how Camera adjusts colors in different kinds of light, to achieve the most natural-looking colors.
 - +  **Incandescent** - Adjust the white balance for incandescent lighting.
 - +  **Fluorescent** - Adjust the white balance for florescent lighting.
 - +  **Auto** - Adjust the white balance automatically (default).
 - +  **Daylight** - Adjust the white balance for daylight.
 - +  **Cloudy** - Adjust the white balance for a cloudy environment.

TC55 Video Settings

When in Video mode, video settings are displayed on screen. Touch  to display the video settings options.

Touch  to display the photo setting options.

Figure 79: Video Setting Options





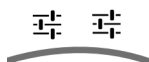

• First 

- **Store location** - Set the camera to store the location the video was taken as part of the video meta data (default – enabled).
- **Flash mode** - Select to turn on flash (default – enabled).

• Second 

- **Video quality** - Touch to select video quality:
 - + **HD 1080p** - High definition 1080p (default).
 - + **HD 720p** - High definition 720p.
 - + **SD 480p** - Standard definition 480p.
- **Time lapse** - Touch to select a time interval to set the frame rate for time lapse photography. Options: **Off** (default), Slide switch to **ON** and then set time interval.
- **White balance** - Touch to select how Camera adjusts colors in different kinds of light, to achieve the most natural-looking colors.
 - +  **Incandescent** - Adjust the white balance for incandescent lighting.

- +  **Fluorescent** - Adjust the white balance for florescent lighting.
- +  **Auto** - Adjust the white balance automatically (default).
- +  **Daylight** - Adjust the white balance for daylight.
- +  **Cloudy** - Adjust the white balance for a cloudy environment.
- **Flash mode** - Select to turn on flash (default – disabled).

Gallery





Note:

The device supports the following image formats: jpeg, gif, png and bmp.

The device supports the following video formats: H.263, H.264 and MPEG4 Simple Profile.

Use **Gallery** to:

- view photos
- play videos
- perform basic editing of photos
- set photos as wallpaper
- set photos as a contact photo
- share photos and videos.

To open the Gallery application, touch  >  or in the camera application touch the thumbnail image at the top right.

Gallery presents all photos and videos stored on the microSD card.

Figure 80: Gallery — Albums

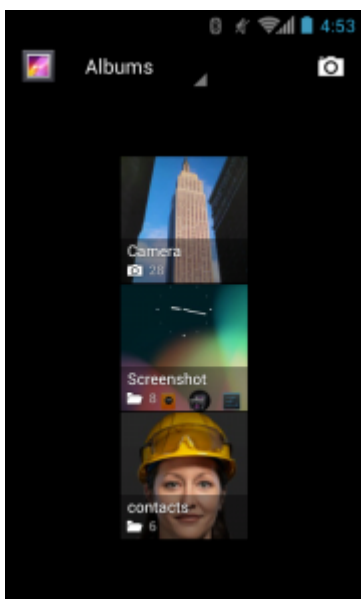

- Touch an album to open it and view its contents. The photos and videos in the album are displayed in chronological order.
- Touch a photo or video in an album to view it.

- Touch  icon (top left corner) to return to the main **Gallery** screen.

Working with Albums

Albums are groups of images and videos in folders. Touch an album to open it. The photos and videos are listed in a chronologically ordered grid. The name of the album displays at the top of the screen.



Figure 81: Photos Inside an Album



Swipe left or right to scroll images across the screen.



Share an Album

Procedure:

- 1 Touch .
- 2 Touch .
- 3 Touch and hold an album until it highlights.
- 4 Touch other albums as required.
- 5 Touch . The Share menu opens. Touch the application to use to share the selected albums.
- 6 Follow the instructions within the selected application.

Get Album Information

Procedure:



- 1 Touch .
- 2 Touch .
- 3 Touch and hold an album until it highlights.

- 4 Touch .
- 5 Touch **Details**.

Deleting an Album

To delete an album and its contents:

Procedure:

- 1 Touch .
- 2 Touch .
- 3 Touch and hold an album until it highlights.
- 4 Check other albums to delete. Ensure that other albums are selected.
- 5 Touch  > **Delete**.
- 6 In the **Delete selected item?** menu, touch **OK** to delete the album.

Working with Photos

Use **Gallery** to view photos on the microSD card and edit and share photos.

Viewing and Browsing Photos

To view a photo:

Procedure:



- 1 Touch .
- 2 Touch .
- 3 Touch an album to open it.
- 4 Touch a photo.

Figure 82: Photo Example

- 5 Swipe left or right to view the next or previous photo in the album.
- 6 Turn the device to view the photo in upright (portrait) or sideways (landscape) orientation. The photo is displayed (but not saved) in the new orientation.
- 7 Touch the photo to view the controls.
- 8 Double-tap the screen to zoom in or pinch two fingers together or spread them apart to zoom in or out.
- 9 Drag the photo to view parts that are not in view.

Rotating a Photo

Procedure:

- 1 Touch a photo to view the controls.
- 2 Touch .
- 3 Touch **Rotate Left** or **Rotate Right**.
The photo is automatically saved with the new orientation.

Cropping a Photo

Procedure:





- 1 In **Gallery**, touch a photo to view the controls.
- 2 Touch .
- 3 Touch **Crop**. The cropping tool appears.
- 4 Use the cropping tool to select the portion of the photo to crop.
 - Drag from the inside of the cropping tool to move it.
 - Drag an edge of the cropping tool to resize it to any proportion.
 - Drag a corner of the cropping tool to resize it with fixed proportions.

Figure 83: Cropping Tool

- 5 Touch **OK** to save a copy of the cropped photo. The original version is retained.



Setting a Photo as a Contact Icon

Procedure:

- 1 Touch .
- 2 Touch .
- 3 Touch an album to open it.
- 4 Touch the photo to open it.
- 5 Touch .
- 6 Touch **Set picture as**.
- 7 Touch **Contact photo**.
- 8 In the **People** application, touch a contact.
- 9 Touch the blue box and crop the photo accordingly.
- 10 Touch **OK**.



Get Photo Information

Procedure:

- 1 Touch .
- 2 Touch .
- 3 Touch an album to open it.
- 4 Touch the photo to open it.
- 5 Touch .
- 6 Touch **Details**.
- 7 Touch **Close**.



Share a Photo

Procedure:

- 1 Touch .
- 2 Touch .
- 3 Touch an album to open it.
- 4 Touch a photo to open it.
- 5 Touch .
- 6 Touch the application to use to share the selected photo. The application selected opens with the photo attached to a new message.

Deleting a Photo

Procedure:

- 1 Touch .
- 2 Touch .
- 3 Touch an album to open it.
- 4 Touch a photo to open it.
- 5 Touch  (Jelly Bean) or  > **Delete** (KitKat).
- 6 Touch **OK** to delete the photo.

Working with Videos

Use **Gallery** to view videos and share videos.

Watching Videos

Procedure:









- 1 Touch .
- 2 Touch .
- 3 Touch an album to open it.
- 4 Touch a video.

Figure 84: Video Example

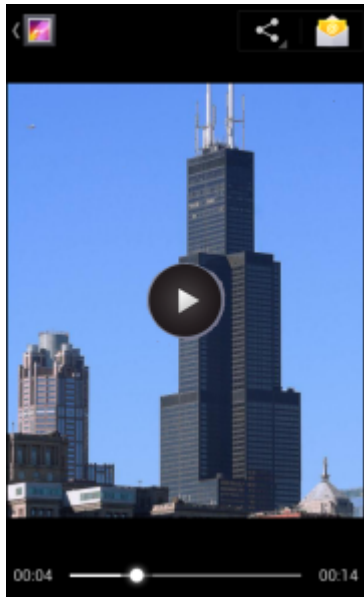
- 5  Touch . The video begins to play.
- 6 Touch the screen to view the playback controls.





Sharing a Video

Procedure:

- 1 Touch .
- 2 Touch .
- 3 Touch an album to open it.
- 4 Touch a video to open it.
- 5  Touch . The Share menu appears.
- 6 Touch the application to use to share the selected video. The application selected opens with the video attached to a new message.

Deleting a Video

Procedure:

- 1 Touch .
- 2 Touch .
- 3 Touch an album to open it.
- 4 Touch a video to open it.
- 5  Touch  (Jelly Bean) or  > **Delete** (KitKat).
- 6 Touch **OK**.

DataWedge Demonstration

Use **DataWedge Demonstration** to demonstrate data capture functionality.

Figure 85: DataWedge Demonstration Window

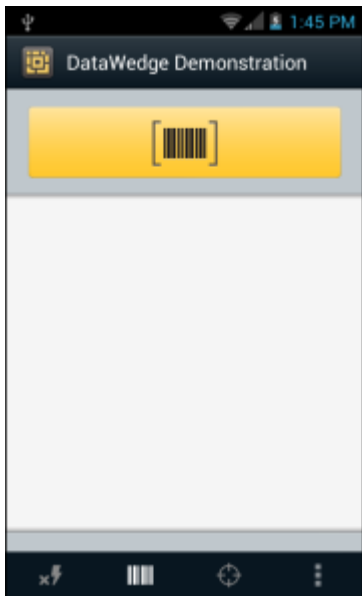

Table 9: DataWedge Demonstration Icons

Icon	Description
	Toggles the flash on and off when using the camera to capture bar code data. Use the flash in dimly lit areas.
	Toggles the data capture function between the imager and camera. If the device does not have an imager, only camera icon is active.
	Toggles between normal scan mode and picklist mode when using the camera to capture bar code data.
	Opens a menu to view the application information or to set the application DataWedge profile.



Note:

See the *TC55 Integrator Guide* for information on DataWedge configuration.

Either press the programmable button or touch the yellow scan button to enable data capture. The captured data appears in the text field below the yellow button.

Movie Studio

Movie Studio is a video editing application. Capture or upload videos or photos and Movie Studio automatically turns them into beautifully edited movies, complete with music and effects. Key features include:

- Select video, photo and music files from the device.

- Trim and edit video clips.
- Delete the middle part from a video.
- Split a video file into several separate clips.
- Adding video effects (fade in, fade out , gray tone, negative, slow-motion).
- Add and edit the background music for the movie.
- Add multiple pictures as slide show movies.

Figure 86: Movie Studio Application

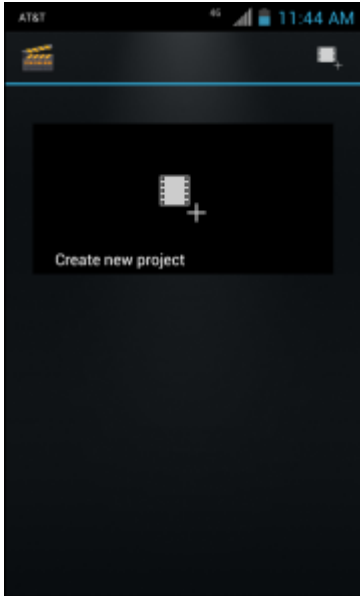

DataWedge Demonstration

Use **DataWedge Demonstration** to demonstrate data capture functionality.

Figure 87: DataWedge Demonstration Window

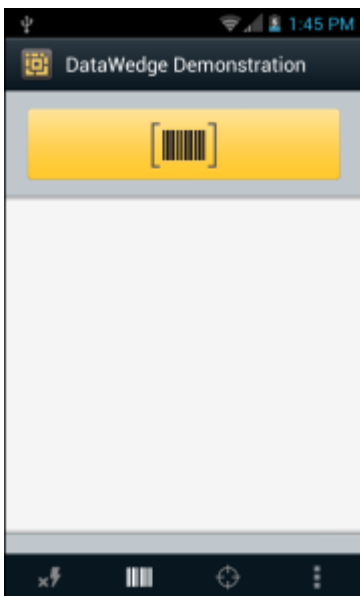
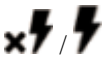





Table 10: DataWedge Demonstration Icons

Icon	Description
	Toggles the flash on and off when using the camera to capture bar code data. Use the flash in dimly lit areas.
	Toggles the data capture function between the imager and camera. If the device does not have an imager, only camera icon is active.
	Toggles between normal scan mode and picklist mode when using the camera to capture bar code data.
	Opens a menu to view the application information or to set the application DataWedge profile.

**Note:**

See the *TC55 Integrator Guide* for information on DataWedge configuration.

Either press the programmable button or touch the yellow scan button to enable data capture. The captured data appears in the text field below the yellow button.

Sound Recorder

Use **Sound Recorder** to record audio messages.

Recordings are saved on the microSD card (if installed) or the Internal Storage and available in the Music application playlist titled "My Recordings."

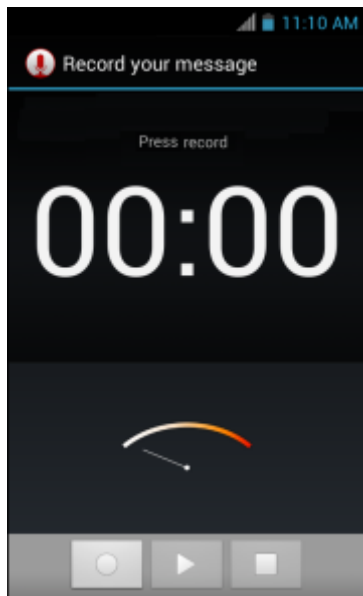
Figure 88: Sound Recorder Application

Elemesz



Note:

Elemesz collects specific device information in the background and sends this information to us to help improve product functionality. This feature can be disabled. See [Disabling Elemesz Data Collection on page 106](#).

Use **Elemesz** to provide diagnostics information to Zebra. Touch **Submit Diagnostics** button to send the data.

Figure 89: Elemesz Application

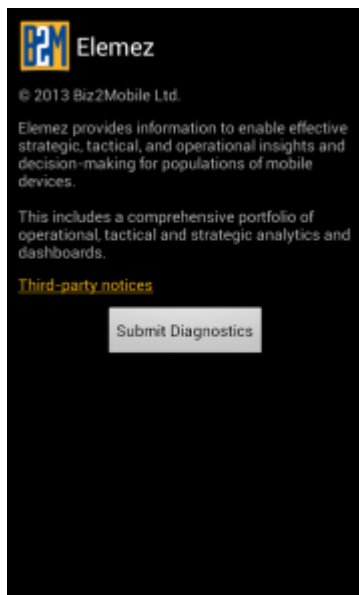

Disabling Elemesz Data Collection

The user can disable the **Elemesz** application from collection specific data in the background and sending it to Zebra Technologies.





Procedure:

- 1 From the Home screen, touch
- 2 Touch **Manage Apps**.
- 3 Swipe left or right until the **ALL** tab displays.
- 4 Scroll through the list and touch **Elemesz**.
- 5 In the **App info** screen, touch **Uninstall updates**.
- 6 In the **Uninstall updates** dialog box, touch **OK**.
- 7 Touch **OK**.
- 8 After uninstall is complete, touch **OK**.
- 9 In the **All** tab, scroll through the list and touch **Elemesz**.
- 10 Touch **Disable**.
- 11 In the **Disable built-in app?** dialog box, touch **OK**.
- 12 Touch

Enabling Elemez Data Collection

The user can re-enable the **Elemez** application for collection specific data in the background and sending it to Zebra Technologies.

Procedure:

- 1 From the Home screen, touch .
- 2 Touch **Manage Apps**.
- 3 Swipe left or right until the **ALL** tab displays.
- 4 Scroll through the list and touch **Elemez**.
- 5 In the **App info** screen, touch **Enable**.
- 6 Touch .
- 7 Touch .
- 8 Touch .
- 9 Touch **Enable Elemez**.

MLog Manager

Use **MLog Manager** to capture log files for diagnostics. See the *TC55 Integrator Guide* for detailed information on configuring the application.

Figure 90: MLog Manager

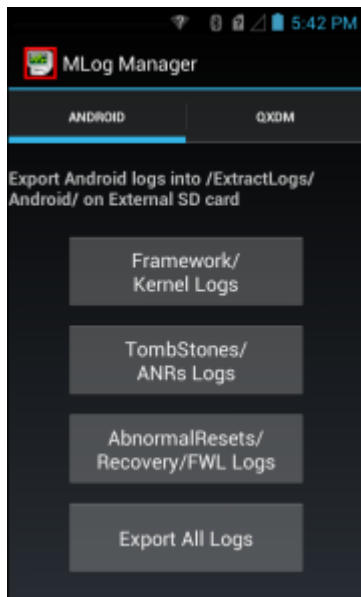

SimulScan Demo



Note: SimulScan Demo is not available on all configurations.

The SimulScan application is an out of the box demonstration application included on the device that support SimulScan. The application enables pre-sales personnel to showcase the various features of SimulScan to customers by employing use-cases in the two most popular verticals, Postal/Transportation and Logistics and Manufacturing. The Transportation and Logistics example showcases the OCR and OMR features. The Manufacturing example showcases the MultiCode 20 feature. SimulScan also allows customers to create templates using the Template Builder and then testing on the device.

Figure 91: SimulScan Demo Home Screen



Exporting Sample Forms

In order to perform the Postal, Transportation & Logistics or Manufacturing demonstrations, print the example forms stored on the device.

Procedure:

- 1 Launch **SimulScan Demo** application.
- 2 On the **SimulScan Demo** home screen, touch **HOW TO USE THIS DEMO**.
- 3 Scroll down and touch **Export sample forms** button. The device copies the forms to the `\simulscan` `\samples` folder in Internal Storage.
- 4 Connect the device to a computer using the USB Charging cable.
- 5 Copy the files from the `\simulscan\samples` folder in Internal Storage to the computer.
- 6 Print the forms.

Postal, Transportation and Logistics Example

The Postal, Transportation and Logistics example uses the following form:.

Figure 92: Postal, Transportation and Logistics Form

1 Payer account number and insurance details		2 Non-Document Shipments Only (Customs Requirements)		3 From (Shipper)		4 To (Receiver)		5 Shipper's agreement			
Charge to <input checked="" type="checkbox"/> Shipper <input type="checkbox"/> Receiver <input type="checkbox"/> 3rd party <small>Not all payment options are available in all countries.</small> Payer Account No.: 001-12349876		Attach the original and four copies of a Proforma or Commercial Invoice Shipper's VAT/GST number: 564451112 Receiver's VAT/GST or Shipper's EIN/SSN: 1111577738 Harmonized Commodity Code if applicable:		Shipper's account number: 155-22263 Company name: Pure Theory Ltd Address: 1638 Landsdown Drive, Fitzrovia, London, England, WC2 1AB Contact name: Scott Andrews, Phone, Fax or E-mail required: 0207 553633		Company name: TFW Solutions Delivery address: <small>We cannot deliver to a PO Box</small> Solvalla, Träsbaneplan 12A 64 Bromma Postcode/Zip Code (required): 266 32, Country: Sweden Contact person: Aidan Peterson, Phone, Fax or E-mail required: +46 8 123 89 67		Shipment insurance (see reverse) <input checked="" type="checkbox"/> Via insurance value (in local currency): 1400		Destination duties/taxes if not paid receiver pays duties/taxes: <input type="checkbox"/> Receiver <input type="checkbox"/> Shipper <input type="checkbox"/> Other _____ <small>specify approved account number</small> Declared Value for Customs (as on commercial/proforma invoice)	
Signature required: <small>Unless otherwise agreed in writing, we agree to the Terms and Conditions of Carriage between the shipper and receiver. These are Conditions and where applicable, the Convention only and/or excluded liability for loss, damage or delay and (2) this agreement does not constitute each or any part of a contract (see Article 1000).</small>		Signature:  Date: 10 / 10 / 13		<small>For more information visit our website or call our local office.</small>							

Procedure:

- 1 Place the form on a flat surface.
- 2 On the device, launch **SimulScan Demo** application.
- 3 Touch the **Menu** icon in the top right corner of the screen.
- 4 Touch **Postal, Transportation & Logistics**.
- 5 Touch **Start SimulScan**.
- 6 Use the image control at the bottom of the screen to control the flash, audio and zoom level.

Figure 93: Image Controls



- 7 Position the camera over the form. Ensure that the complete border of the form is visible on the screen.
- 8 Hold the device steady.
- 9 Once the device detects the form **Tap Screen to Scan** appears on the screen.

10 Tap the screen to start the data capture. When completed, the device beeps and the data from the form displays.

Figure 94: Postal Data Screen

Field	Parsed Data
Barcode	123456-789A
Charge To	<input checked="" type="checkbox"/>
Account Number	155-22263
Shipper Name	▲ Check Result Pure Theory Ltd
Shipper Address	▲ Check Result 1631 LaDWS@Bwn Drive Fitzrovia, London

Buttons: Rescan, Accept

11 Touch the text boxes to correct any errors. Note: if there are too many errors, touch **Rescan** to perform the capture again.

12 Touch **Accept** to confirm the data is correct. The **Results summary** screen appears.

13 Touch **OK**.

Manufacturing Example

The Postal, Transportation and Logistics example uses the following form:

Figure 95: Manufacturing Form

reader <5 kgs MV unit

PART NUMBER (P) 5290261-69

SUPPLIER (S) 4305156059

QUANTITY (Q) 000128

PKG ID/SERIAL NUMBER (IS) X1 000114

MADE IN MEXICO

MANUFACTURING LTD

Procedure:

- 1 Copy the sample form from the device to a computer. See
- 2 Print this form.
- 3 Place the form on a flat surface.

- 4 On the device, launch **SimulScan Demo** application.
- 5 Touch the **Menu** icon in the top right corner of the screen.
- 6 Touch **Manufacturing**.
- 7 Touch **Start SimulScan**.
- 8 Point the top of the device at the document and center the target on the document.
- 9 Hold the device steady.
- 10 The device starts the data capture. When completed, the device beeps and the data from the document displays.

Figure 96: Manufacturing Data

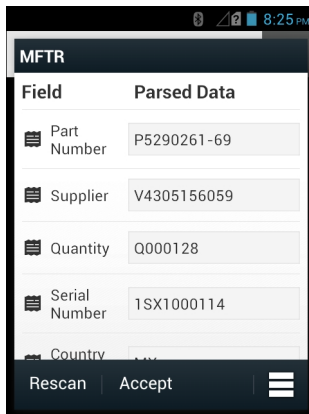

- 11 Touch the text boxes to correct any errors. If there are too many errors, touch **Rescan** to perform the capture again.
- 12 Touch **Accept** to confirm the data is correct. The **Results summary** screen appears.
- 13 Touch **OK**.

Settings

To set the settings for the **SimulScan Demo** application touch **Menu** icon > **Settings**.

Figure 97: Settings Screen

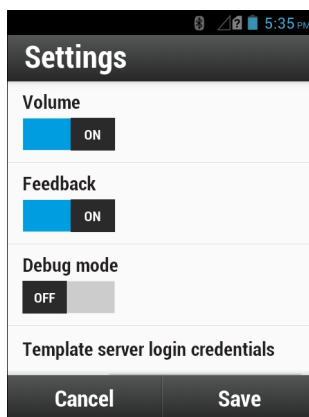

- **Volume** - Toggle switch to turn audible notification on and off.
- **Haptic** - Toggle switch to turn vibration notification on and off.
- **Debug mode** - Toggle switch to enable or disable debug mode.
- **Template server login credentials** - enter credentials for accessing the template server.

Advanced Settings

Use the Advanced setting to configure data capture options. In the data capture screen, touch  in the bottom right corner of the screen.

Figure 98: Advanced Settings Screen



- **Identification Timeout** - Set the amount of time to wait before timing out identifying the target document. Options: **2 seconds**, **5 seconds**, **10 seconds**, **15 seconds**, **20 seconds** or **25 seconds**.
- **Processing Timeout** - Once the target document is identified, amount of time to wait before timing out processing.
- **Audio Feedback** - Turn on or off audio feedback on successful parse.
- **Haptic Feedback** - Turn on or off haptic (vibration) feedback on successful parse.
- **LED Feedback** - Turn on or off LED feedback on successful parse.
- **Debug Mode** - If enabled, allows a session to write form capture, region images, region values, and other data to storage. Use only when directed by administrator.
- **Auto Capture** - Set to **On** to automatically capture forms when detected. Set to **Off** to manually capture forms when user taps screen or presses a trigger button.
- **Image Correction** - Turn on when document is crumpled or curved and requires advanced image correction.
- **Capture Sensitivity** - Increase sensitivity for increased document identification accuracy before processing.
- **About** - Displays the SimulScan Engine version number.
- **Quit Scanner** - Exit Advanced Settings screen.

Demo Customization

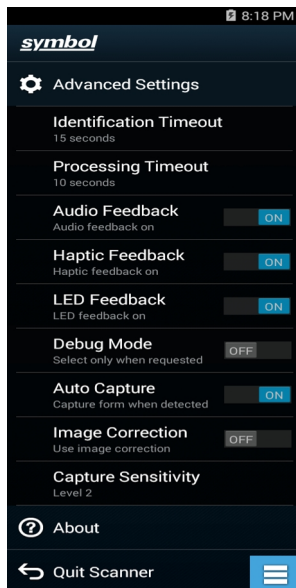
Before creating a customized demo, first:

- Create a template using the Template Builder tool.
- Copy a company logo and image to the device storage location.

Procedure:

- 1 Touch **Menu** icon.
- 2 Touch **Custom Demo Setup**.

Figure 99: Custom Demo Setup Screen

- 3 In the **Name** text box, enter a name for the custom demo. This name appears in the drop-down menu..
- 4 In the **Custom Demo Setup** text box, enter a title for the demo. This appears in the demo screen title box.
- 5 Touch the **Image** field to select an image from the SD card.
- 6 Touch the **Logo** field to select the logo image from the SD card.
- 7 In the **Introduction** text box, enter text that will appear on the demo screen.
- 8 In the **Header color** text box, enter the hex color value for the header.
- 9 In the **Icon color** text box, enter the hex color value for Menu icon and button text.
- 10 In the **Key Features** text box, enter text that will appear under the Key Feature heading. This text appears in bullet format.
- 11 Touch one of the **SimulScan Document Capture Template** fields to select a template
 - a **Browse external storage** - select a template loaded on the device.
 - b **Default templates** - select one of the default templates.
 - c **Select from server** - . select a template from the SimulScan server.
- 12 Touch **Done**. The customized example appears on the screen.
- 13 Touch **Start SimulScan** to begin the demonstration.

Default Templates

The following templates are available:

- **Default - BankCheck.xml** – Use this template to read the MICR E-13B font (length between 19 and 40 characters) on bank checks.
- **Default - Barcode 1.xml** – Use this template to read a single supported bar code.
- **Default - Barcode 10.xml** – Use this template to read up to 10 supported bar codes.
- **Default - Barcode 2.xml** – Use this template to read two supported bar codes.
- **Default - Barcode 4.xml** – Use this template to read up to supported four bar codes.
- **Default - Barcode 5.xml** – Use this template to read up to supported five bar codes.
- **Default - BookNumber.xml** – Use this template to read the OCR-B ISBN 10 or 13 digit book numbers.
- **Default - DocCap + Optional Barcode** – Use this template to capture a full page image and decode any supported bar codes that are in the form. The captured area is the largest rectangular region in the field of view defined by the solid border or contrast of background. Any OCR or OMR content will not be decoded in this mode. The captured area is further processed to correct, de-skew and sharpen and returned as a picture.
- **Default - DocCap + Required Barcode** – Use this template to capture a full page image and decode of any supported bar codes that are present in the form. The captured area is the largest rectangular region in the field of

view defined by the solid border or contrast of background. Any OCR or OMR content will not be decoded in this mode. The captured area is further processed to correct, de-skew and sharpen and returned as a picture.

- **Default - TravelDoc.xml** – Use this template to read passport and Visa travel documents with OCR-B types A and B fonts.
- **Default - Unstructured Multi-Line** – Use this template to read up to seven lines of text.
- **Default - Unstructured Single Line** – Use this template to read a single line of text.

Chapter

5

Data Capture

The TC55 offers the following data capture options:

- integrated linear imager
- integrated 2D imager
- integrated digital camera
- optional CS3070 Bluetooth scanner
- optional RS507 Hands-free Bluetooth imager.



Note: DataWedge is installed and enabled on the TC55 by default.

Linear Imager

The device with an integrated linear imager has the following features:

- Reading a variety of bar code symbologies, including the most popular 1-D code types.
- Intuitive aiming for easy point-and-shoot operation.

The imager uses digital camera technology to take a digital picture of a bar code, stores the resulting image in its memory, and executes state-of-the-art software decoding algorithms to extract the data from the image.

Imaging

The TC55 with an integrated 2D imager has the following features:

- Omnidirectional reading of a variety of bar code symbologies, including the most popular linear, postal, PDF417, and 2D matrix code types.
- The ability to capture and download images to a host for a variety of imaging applications.
- Advanced intuitive laser aiming cross-hair and dot aiming for easy point-and-shoot operation.

The imager uses imaging technology to take a picture of a bar code, stores the resulting image in its memory, and executes state-of-the-art software decoding algorithms to extract the bar code data from the image.

Operational Modes

The TC55 with an integrated imager supports modes of operation, listed below. Activate each mode by pressing the Scan button.

- **Decode Mode:** In this mode, the TC55 attempts to locate and decode enabled bar codes within its field of view. The imager remains in this mode as long as the user holds the scan button, or until it decodes a bar code.



Note: To enable Pick List Mode, configure in DataWedge or set in an application using a API command.

- **Pick List Mode:** This mode allows the user to selectively decode a bar code when more than one bar code is in the TC55 's field of view. To accomplish this, move the aiming crosshair or dot over the required bar code to decode only this bar code. This feature is ideal for pick lists containing multiple bar codes and manufacturing or transport labels containing more than one bar code type (either 1D or 2D).

Digital Camera

The device with an integrated camera based bar code scanning solution has the following features:

- Omnidirectional reading of a variety of bar code symbologies, including the most popular linear, postal, QR, PDF417, and 2D matrix code types.
- Cross-hair reticle for easy point-and-shoot operation.
- Picklist mode to decode a particular bar code from many in the field of view.

The solution uses the advanced camera technology to take a digital picture of a bar code, and executes state-of-the-art software decoding algorithms to extract the data from the image.

CS3070 Bluetooth Scanner

The CS3070 Bluetooth laser scanner captures bar code data, and transmits it to the device via Bluetooth. The scanner supports Bluetooth Human Interface Device (HID) connection to the device where the scanner emulates a keyboard.

Figure 100: CS3070 Bluetooth Scanner

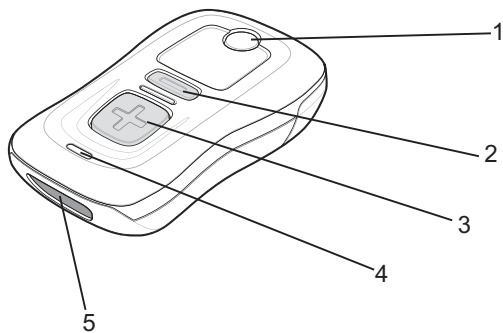

- 1 Bluetooth Button/LED
- 2 Delete Button
- 3 Scan Button
- 4 LED
- 5 Exit Window

See the *CS3000 Series Scanner Product Reference Guide* for detailed information for configuring the CS3070.

RS507 Hands-Free Imager

The RS507 Hands-free Imager is a wearable bar code scan solution for both 1D and 2D bar code symbologies. The scanner supports Bluetooth Human Interface Device (HID) connection to the device where the scanner emulates a keyboard.

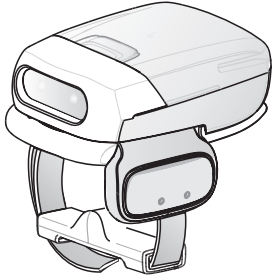
Figure 101: RS507 Hands-Free Imager

See to the *RS507 Hands-free Imager Product Reference Guide* for more information.

Scanning Considerations

Typically, scanning is a simple matter of aim, scan, and decode where a few quick trial efforts master it. However, consider the following to optimize scanning performance:

- Range
 - Any scanning device decodes well over a particular working range — minimum and maximum distances from the bar code. This range varies according to bar code density and scanning device optics.
 - Scanning within range brings quick and constant decodes; scanning too close or too far away prevents decodes. Move the scanner closer and farther away to find the right working range for the bar codes being scanned.
- Angle
 - Scan angle is important for promoting quick decodes. When laser beams reflect directly back into the scanner from the bar code, this specular reflection can “blind” the scanner.
 - To avoid this, scan the bar code so that the beam does not bounce directly back. But do not scan at too sharp an angle; the scanner needs to collect scattered reflections from the scan to make a successful decode. Practice quickly shows what tolerances to work within.
- Hold the device farther away for larger symbols.
- Move the device closer for symbols with bars that are close together.



Note: Scanning procedures depend on the application and device configuration. An application may use different scanning procedures from those described.

Scan Mode



Note: Scan Mode is only available on TC55 with 2D imager.

Use the **Scan Mode** application to configure the TC55 buttons for scanning.

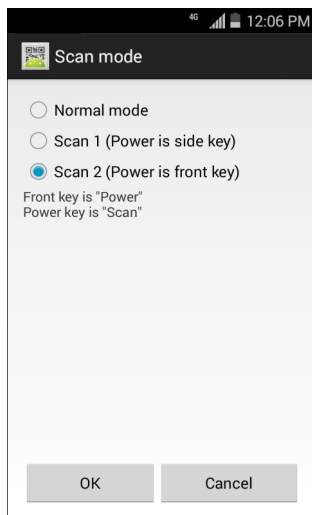
Figure 102: Scan Mode Application

- **Normal mode** - Default settings. Configures the following:
 - Press the Scan key to enable scanning.
 - Press the Power key to turn the TC55 on and off.
- **Scan 1 (Power is side key)** - Configures the following:
 - Press the Scan key to turn the TC55 on and off.
 - Press the Power key to enable scanning.
- **Scan 2 (Power is front key)** - Configures the following:
 - Press the Scan key or Power key to enable scanning.
 - Press the Power key to wake the TC55.
 - Press  to turn off the TC55.

Bar Code Capture with Linear Imager

To capture bar code data:

Procedure:

- 1 Ensure that an application is open on the TC55 and a text field is in focus (text cursor in text field).
- 2 Point the top of the TC55 at a bar code.

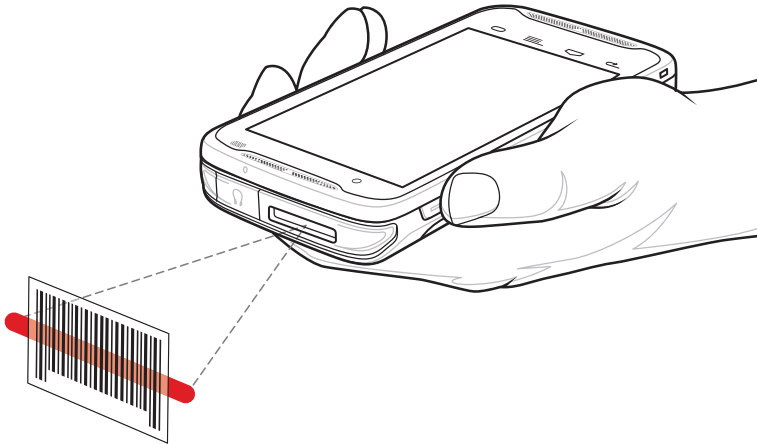
Figure 103: Scanning

- 3 Press and hold the Programmable button. The LED lights red to indicate that data capture is in process.
- 4 Place the red aiming pattern across the bar code. The LED lights green and a beep sounds, by default, to indicate the bar code was decoded successfully.

Figure 104: Aiming Pattern

- 5 The captured data appears in the text field.

Bar Code Capture with 2D Imager

To capture bar code data:

Procedure:

- 1 Ensure that an application is open on the TC55 and a text field is in focus (text cursor in text field).
- 2 Point the top of the TC55 at a bar code.

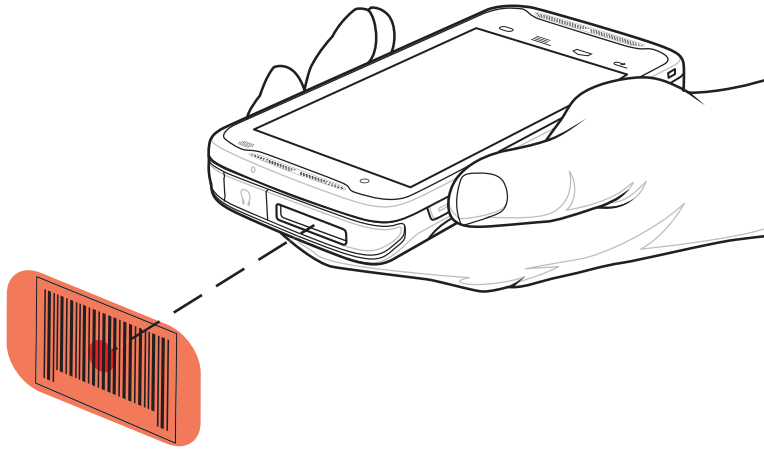
Figure 105: Scanning

- 3 Press and hold the Programmable button.
- 4  **Note:** When the TC55 is in Picklist mode, the imager does not decode the bar code until the aiming dot touches the bar code.

Ensure the bar code is within the area formed by the aiming pattern. The aiming dot is used for increased visibility in bright lighting conditions.

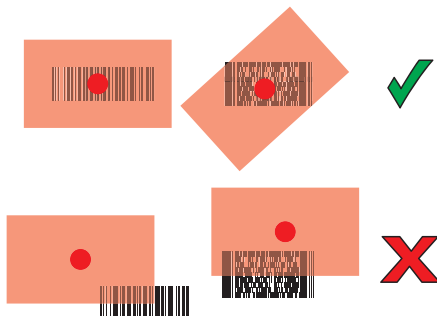
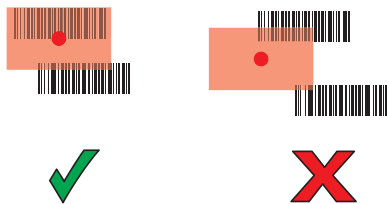
Figure 106: Aiming Pattern**Figure 107: Pick List Mode with Multiple Bar Codes in Aiming Pattern**

- 5 The captured data appears in the text field.

Bar Code Capture with Integrated Camera

To capture bar code data:





Note: When capturing bar code data in poor lighting, turn on **Illumination mode** in the **DataWedge** application. See the *TC55 Integrator Guide* for detailed information on configuring **DataWedge**.

Procedure:

- 1 Ensure that an application is open on the device and a text field is in focus (text cursor in text field).
- 2 Aim the camera at a bar code.
- 3 Press and hold the Programmable button. By default, a preview window appears on the screen. The Decode light emitting diode (LED) lights red to indicate that data capture is in process.

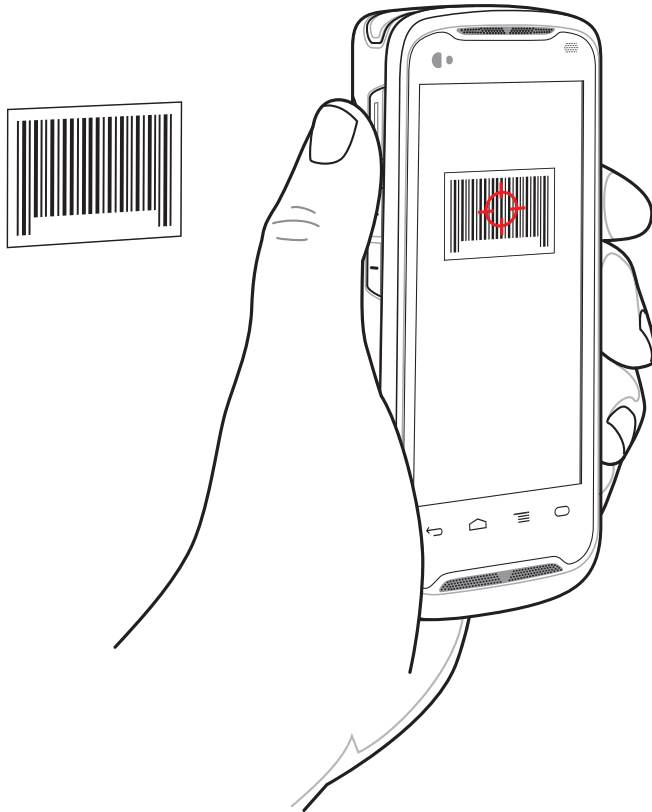
Figure 108: Application with Preview Window



- 4  **Note:** When Picklist mode is enabled, move the TC55 until the bar code is centered under the red target on the screen.

Move the TC55 until the bar code is visible on the screen.

- 5 The Decode LED lights green, a beep sounds and the device vibrates, by default, to indicate the bar code was decoded successfully.
- 6 The captured data appears in the text field.

Bar Code Capture with CS3070 Bluetooth Scanner

Prerequisites: Pair the CS3070 with the device. See *Pairing with the CS3070 on page 144* for more information.

Procedure:

- 1 Ensure that an application is open on the device and a text field is in focus (text cursor in a text field).
- 2 Aim the scanner at the bar code.
- 3 Press the scan (+) button.

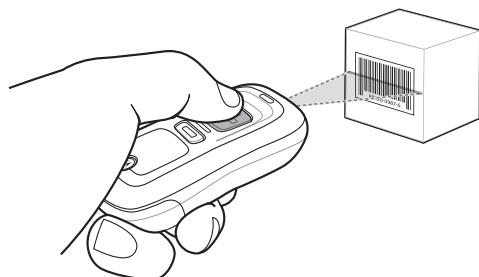
Figure 109: CS3070 Scanning

- 4 Ensure the scan line crosses every bar and space of the symbol.

Figure 110: Linear Scanner Aiming Pattern

- 5 The scanner beeps and the LED turns green to indicate a successful decode.
- 6 The captured data appears in the text field.

Bar Code Capture with RS507 Hands-Free Imager

Prerequisites: Pair the RS507 with the TC55. See [Pairing the RS507 Hands-Free Imager on page 146](#) for more information.

Procedure:

- 1 Ensure that an application is open on the device and a text field is in focus (text cursor in text field).
- 2 Point the RS507 at a bar code.

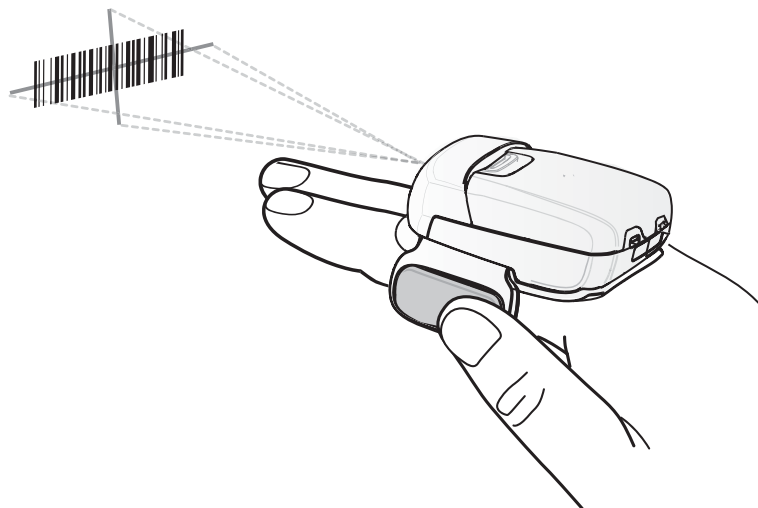
Figure 111: Bar Code Scanning with RS507

- 3 Press and hold the trigger.

The red laser aiming pattern turns on to assist in aiming. Ensure the bar code is within the area formed by the cross-hairs in the aiming pattern. The aiming dot is used for increased visibility in bright lighting conditions.

The RS507 LEDs light green, a beep sounds to indicate the bar code was decoded successfully. Note that when the RS507 is in Pick List Mode, the RS507 does not decode the bar code until the center of the crosshair touches the bar code.

Figure 112: Aiming Pattern

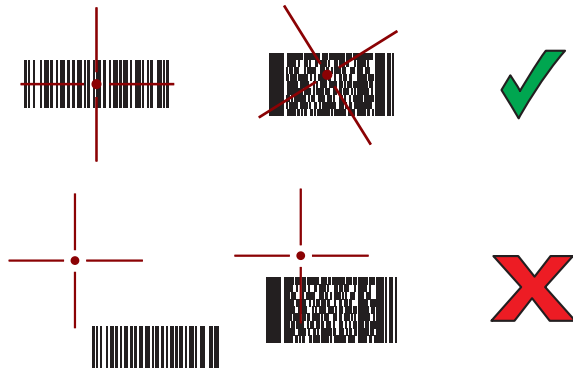

Figure 113: Pick List Mode with Multiple Bar Codes in Aiming Pattern



- 4 The captured data appears in the text field.





DataWedge

DataWedge is a utility that adds advanced bar code scanning capability to any application without writing code. It runs in the background and handles the interface to built-in bar code scanners. The captured bar code data is converted to keystrokes and sent to the target application as if it was typed on the keypad.

To configure DataWedge refer to the *TC55 Integrator Guide*.





Enabling DataWedge

Procedure:

- 1 Touch .
- 2 Touch .
- 3 Touch .
- 4 Touch **Settings**.
- 5 Touch the **DataWedge enabled** checkbox. A blue checkmark appears in the checkbox indicating that DataWedge is enabled.
- 6 Touch .

Disabling DataWedge

Procedure:

- 1 Touch .
- 2 Touch .
- 3 Touch .
- 4 Touch **Settings**.
- 5 Touch the **DataWedge enabled** checkbox. The blue checkmark disappears from the checkbox indicating that DataWedge is disabled.
- 6 Touch .

Chapter 6

Wireless

This section provides information on the wireless features:

- Wireless Wire Area Network (WWAN)
- Wireless Local Area Network (WLAN)
- Bluetooth
- Near Field Communications (NFC)

Wireless Wide Area Networks

Use Wireless wide area networks (WWANs) to access data over a cellular network. This section provides information on:

- Sharing a data connection
- Disabling data roaming
- Monitoring data usage
- Limiting connections to 2G networks
- Locking a SIM card
- Verizon Network mode
- Verizon system select
- Editing Access Point Names (APNs).

Sharing the Mobile Data Connection

The **tethering & portable hotspot** settings allow you to share your data connection. You can share the TC55's mobile data connection with a single computer via USB tethering or Bluetooth tethering. You can also share the data connection with up to eight devices at once, by turning it into a portable Wi-Fi hotspot. While the TC55 is sharing its data connection, an icon appears at the top of the screen and a corresponding message appears in the notification list.



USB Tethering



Note: USB tethering is not supported on computers running Mac OS. If your computer is running Windows 7 or a recent version of Linux (such as Ubuntu), follow these instructions without any special preparation. If running a version of Windows that precedes Windows 7, or some other operating system, you may need to prepare the computer to establish a network connection via USB.

Procedure:

- 1 Connect the TC55 to a host computer with the USB cable.
A USB icon appears at the top of the screen, and the notification **Connected as a media device** or **Connected as a camera** appears briefly at the top of the screen.
- 2 Touch .

- 3 Touch  or .
- 4 Touch **More ...**.
- 5 Touch **Tethering & portable hotspot**.
- 6 Check **USB tethering**.
The host computer is now sharing the TC55's data connection.



Postrequisites: To stop sharing the data connection, uncheck **USB tethering** or disconnect the USB cable.

Bluetooth Tethering

Use Bluetooth tethering to share the data connection with a host computer.

Prerequisites: Configure the host computer to obtain its network connection using Bluetooth. For more information, see the host computer's documentation.

Procedure:



- 1 Pair the TC55 with the host computer.
- 2 Touch .
- 3 Touch  .
- 4 Touch **More ...**.
- 5 Touch **Tethering & portable hotspot**.
- 6 Check **Bluetooth tethering**.
The host computer is now sharing the TC55's data connection.

Postrequisites: To stop sharing the data connection, uncheck **Bluetooth tethering**.

Portable Wi-Fi Hotspot

Prerequisites: Configure the Wi-Fi Hotspot settings.

Procedure:

- 1 Touch .
- 2 Touch  or .
- 3 Touch **More ...**.
- 4 Touch **Tethering & portable hotspot**.
- 5 Check **Portable Wi-Fi hotspot**.
After a moment, the TC55 starts broadcasting its Wi-Fi network name (SSID), so you can connect to it with up to eight computers or other devices.

Postrequisites: To stop sharing the data connection, uncheck **Portable Wi-Fi hotspot**.

Configuring the Wi-Fi Hotspot

Procedure:

- 1 Touch .
- 2 Touch  .
- 3 Touch **More ...**.
- 4 Touch **Tethering & portable hotspot**.

Figure 114: Set up Wi-Fi Hotspot Dialog Box

- 5 In the **Network SSID** text field, edit the network name.
- 6 Touch the **Country** option and select the country you are in from the drop-down list.
- 7 Touch the **Channel** option and select a channel number from the drop-down list.
- 8 Touch the **Security** option and select a security method from the drop-down list.

- **Open**
- **WPA2 PSK**

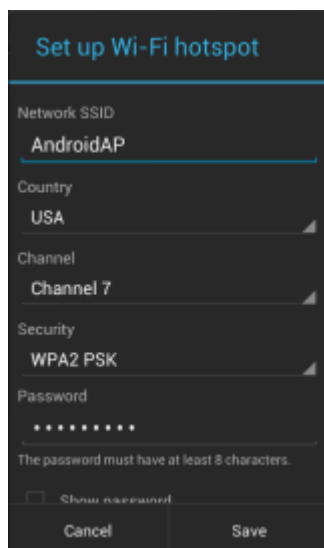

- 9 In the **Password** text field, enter a password.



Note: If **Open** is selected in the **Security** option, a password is not required.

- 10 Touch **Save**.

Data Usage

Data usage refers to the amount of data uploaded or downloaded by the TC55 during a given period. Depending on the wireless plan, you may be charged additional fees when your data usage exceeds your plan's limit. To monitor your data usage, go to  or  >  **Data usage**.



Caution: The usage displayed on the data usage settings screen is measured by your device. Your carrier's data usage accounting may differ. Usage in excess of your carrier plan's data limits can result in steep overage charges. The feature described here can help you track your usage, but is not guaranteed to prevent additional charges.

Data usage settings allow you to:

- Set the data usage level at which you'll receive a warning.
- Set a data usage limit.
- View or restrict data usage by app.
- Identify mobile hotspots and restrict background downloads that may result in extra charges.

By default, when you open the data usage settings screen you see the settings for mobile data: that is, the data network or networks provided by your carrier:

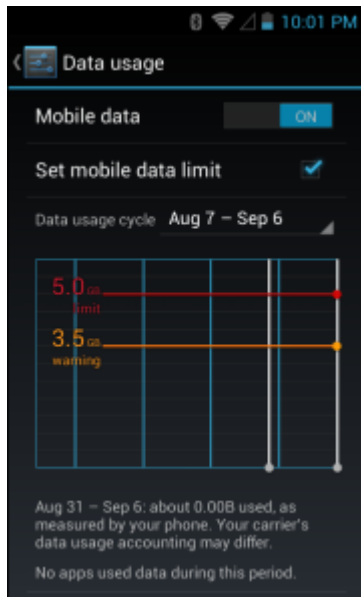
Figure 115: Data Usage Screen

To display Wi-Fi data usage settings in a separate tab touch > **Show Wi-Fi usage**.

Just below the on-off switch, note the data usage cycle. Touch it to choose a different cycle. This date range is the period of time for which the graph displays data usage.

The vertical white lines on the graph show a period of time within the data usage cycle. This range determines the usage amount displayed just below the graph. Drag lines to change the period.

Set Data Usage Warning

Drag the orange line by its right side to the level where you want to receive a warning. When your data usage reaches this level, you'll receive a notification.

Set Auto-Sync

You can also conserve data usage by syncing your apps manually, only when you need the data, rather than relying on auto-sync. To turn auto-sync off or on, touch > **Auto-sync data**.

Disabling Data When Roaming

To prevent the device from transmitting data over other carriers' mobile networks when leaving an area that is covered by the carrier's networks. This is useful for controlling expenses if the service plan does not include data roaming.

Procedure:

- 1 Touch .
- 2 Touch or .
- 3 Touch **More ...**.
- 4 Touch **Mobile networks**.
- 5 Un-check **Data roaming**.
- 6 Touch .





Limiting Data Connection to 2G Networks



Note: Not available when using AT&T SIM card.

Extend the battery life by limiting the data connections to 2G networks (GPRS or EDGE). When connected to a 2G network, the user may want to postpone activities that transmit a lot of data, such as sending, uploading, or downloading pictures or video, until they are connected to a faster mobile or other wireless network.

Procedure:

- 1 Touch .
- 2 Touch  or .
- 3 Touch **More ...**.
- 4 Touch **Mobile networks**.
- 5 Touch **GSM 2G/3G selection**.
- 6 Touch **2G only**.
- 7 Touch .

Locking the SIM Card

Locking the SIM card requires the user to enter a PIN every time the device is turned on. If the correct PIN is not entered, only Emergency calls can be made.

Procedure:





- 1 Touch .
- 2 Touch  or .
- 3 Touch  **Security**.
- 4 Touch **Set up SIM/RUIM card lock**.
- 5 Touch **Lock SIM card**.

Figure 116: Enter PIN to Lock SIM Card



- 6 Enter the PIN associated with the card. Touch **OK**.
- 7 Reset the device.

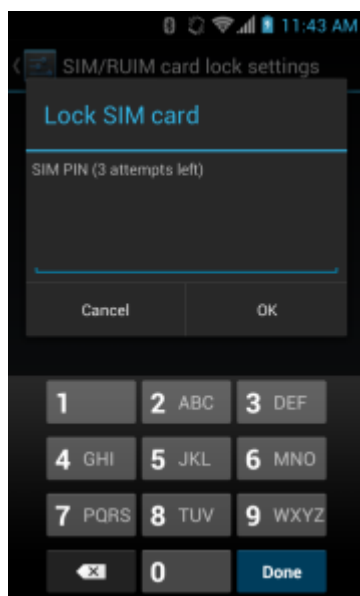

Verizon Network Mode



Note: Only for TC55CH configurations.

Use to change the network operating mode.

Procedure:

- 1 Touch .
- 2 Touch .
- 3 Touch **More ...**.
- 4 Touch **Mobile networks**.
- 5 Touch **Network mode**.
- 6 In the **Preferred network mode** dialog box, select a mode to set as default. Options: **LTE** (TC55CH with LTE only), **CDMA + LTE/EvDo** (TC55CH with LTE only), **EvDo only**, **CDMA w/o EvDo** or **CDMA/EvDo auto**.
- 7 Touch .



Verizon System Select



Note: Only for TC55CH configurations.

Use System select to change the CDMA roaming mode.

Procedure:

- 1 Touch .
- 2 Touch .
- 3 Touch **More ...**.
- 4 Touch **Mobile networks**.
- 5 Touch **System select**.
- 6 In the **System select** dialog box, select a mode. Options:
 - **Home only** - Do not roam from Home network.
 - **Automatic** - Allow automatic roaming.
- 7 Touch .

Editing the Access Point Name





Note: Many service provider Access Point Name (APN) data are pre-configured in the TC55. The APN information for all other service providers must be obtained from the wireless service provider.

To use the data on a network the user must configure the APN information.

Procedure:

- 1 Touch .
- 2 Touch .

- 3 Touch **More ...**.
- 4 Touch **Mobile networks**.
- 5 Touch **Access Point Names**.
- 6 Touch .
- 7 Touch **New APN**.
- 8 Touch each APN settings and enter the appropriate data obtained from the wireless service provider.
- 9 When finished, touch .
- 10 Touch **Save**.
- 11 Touch the radio button next to the new APN name to start using it.
- 12 Touch .

Wireless Local Area Networks

Wireless local area networks (WLANs) allow the TC55 to communicate wirelessly inside a building. Before using the TC55 on a WLAN, the facility must be set up with the required hardware to run the WLAN (sometimes known as infrastructure). The infrastructure and the TC55 must both be properly configured to enable this communication.

Refer to the documentation provided with the infrastructure (access points (APs), access ports, switches, Radius servers, etc.) for instructions on how to set up the infrastructure.

Once the infrastructure is set up to enforce the chosen WLAN security scheme, use the **Wireless & networks** settings to configure the TC55 to match the security scheme.

The TC55 supports the following WLAN security options:

- Open
- Wireless Equivalent Privacy (WEP)
- Wi-Fi Protected Access (WPA)/WPA2 Personal (PSK)
- Extensible Authentication Protocol (EAP)
 - Protected Extensible Authentication Protocol (PEAP) - with Microsoft Challenge-Handshake Authentication Protocol version 2 (MSCHAPv2) and Generic Token Card (GTC) authentication.
 - EAP-Transport Layer Security (TLS)
 - EAP-TTLS - with Password Authentication Protocol (PAP), MSCHAP and MSCHAPv2 authentication.

The **Status** bar displays icons that indicate Wi-Fi network availability and Wi-Fi status. See [Status Bar on page 49](#) for more information.



Note: Turn off Wi-Fi when not using it, to extend the life of the battery.

Scan and Connect to a Wi-Fi Network

Procedure:



- 1 Touch .
- 2 Touch  or .

Figure 117: Settings Screen

- 3 Slide the **Wi-Fi** switch to the **ON** position.
- 4 Touch  **Wi-Fi**. The TC55 searches for WLANs in the area and lists them.

Figure 118: Wi-Fi Screen

- 5 Scroll through the list and select the desired WLAN network.
- 6 For open networks, touch profile once or press and hold and then select **Connect to network** or for secure networks enter the required password or other credentials then touch **Connect**. See the system administrator for more information.

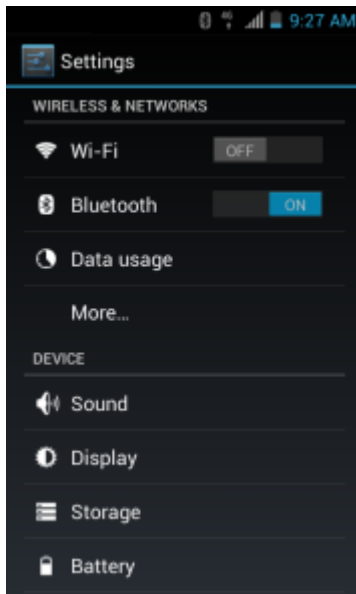
The TC55 obtains a network address and other required information from the network using the dynamic host configuration protocol (DHCP) protocol. To configure the TC55 with a fixed internet protocol (IP) address, See [Configuring the Device to Use a Static IP Address on page 135](#).

- 7 In the Wi-Fi setting field, **Connected** appears indicating that the TC55 is connected to the WLAN.

Configuring a Wi-Fi Network

Procedure:







- 1 Touch .
- 2 Touch  or .
- 3 Touch  **Wi-Fi**.
- 4 Slide the switch to the **ON** position.
- 5 The TC55 searches for WLANs in the area and lists them on the screen.
- 6 Scroll through the list and select the desired WLAN network.
- 7 Touch the desired network. If the network security is **Open**, the TC55 automatically connects to the network. For all other network security a dialog box appears.

Figure 119: WLAN Network Security Dialog Boxes





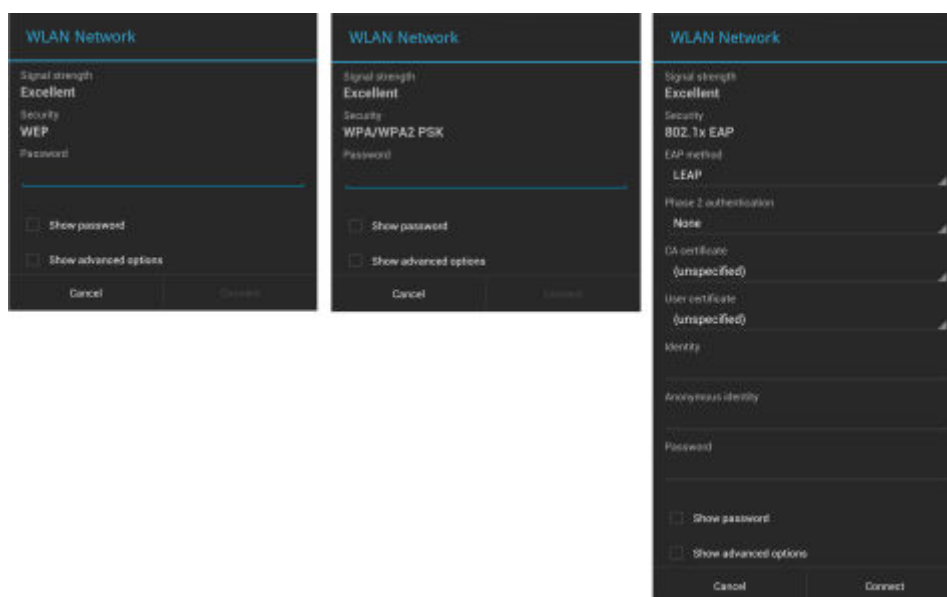

Note: By default, the network Proxy is set to **None** and the IP settings is set to **DHCP**. See [Configuring for a Proxy Server on page 134](#) for setting connection to a proxy server and see [Configuring the Device to Use a Static IP Address on page 135](#) for setting the device to use a static IP address.

- 8 If the network security is **WEP** or **WPA/WPA2 PSK**, enter the required password and then touch **Connect**.
- 9 If the network security is 802.1x EAP, enter the information below and then touch **Connect**:
 - Touch the EAP method drop-down list and select **PEAP**, **TLS** or **TTLS**.
 - Touch the **Phase 2 authentication** drop-down list and select an authentication method.
 - If required, touch **CA certificate** and select a Certification Authority (CA) certificate. Note: Certificates are installed using the **Security** settings.
 - If required, touch **User certificate** and select a user certificate. Note: User certificates are installed using the **Location & security** settings.
 - If required, in the **Identity** text box, enter the username credentials.
 - If desired, in the **Anonymous identity** text box, enter an anonymous identity username.
 - If required, in the **Password** text box, enter the password for then given identity.
- 10 Touch .

Manually Adding a Wi-Fi Network

Manually add a Wi-Fi network if the network does not broadcast its name (SSID) or to add a Wi-Fi network when out of range.

Procedure:

- 1 Touch .
- 2 Touch  or .
- 3 Touch  **Wi-Fi**.
- 4 Slide the Wi-Fi switch to the **On** position.
- 5 Touch + in the bottom right corner of the screen.
- 6  **Note:** By default, the network Proxy is set to **None** and the IP settings is set to **DHCP**. See [Configuring for a Proxy Server on page 134](#) for setting connection to a proxy server and see [Configuring the Device to Use a Static IP Address on page 135](#) for setting the device to use a static IP address.

In the **Network SSID** text box, enter the name of the Wi-Fi network.

- 7 In the **Security** drop-down list, select the type of security. Options:
 - **None**
 - **WEP**
 - **WPA/WPA2 PSK**
 - **802.1x EAP**.
- 8 If the network security is **None**, touch **Save**.
- 9 If the network security is **WEP** or **WPA/WPA2 PSK**, enter the required password and then touch **Save**.
- 10 If the network security is **802.1x EAP** enter the information below and then touch **Save**:
 - Touch the **EAP method** drop-down list and select **PEAP**, **TLS** or **TTLS**.
 - Touch the **Phase 2 authentication** drop-down list and select an authentication method.
 - If required, touch **CA certificate** and select a Certification Authority (CA) certificate. Note: Certificates are installed using the **Security** settings.
 - If required, touch **User certificate** and select a user certificate. Note: User certificates are installed using the **Security** settings.
 - If required, in the **Identity** text box, enter the username credentials.
 - If desired, in the **Anonymous** identity text box, enter an anonymous identity username.
 - If required, in the **Password** text box, enter the password for then given identity.
- 11 Touch .

Configuring for a Proxy Server

A proxy server is a server that acts as an intermediary for requests from clients seeking resources from other servers. A client connects to the proxy server, requesting some service, such as a file, connection, web page, or other resource, available from a different server. The proxy server evaluates the request according to its filtering rules. For example, it may filter traffic by IP address or protocol. If the request is validated by the filter, the proxy provides the resource by connecting to the relevant server and requesting the service on behalf of the client.

It is important for enterprise customers to be able to set up secure computing environments within their companies, and proxy configuration is an essential part of doing that. Proxy configuration acts as a security barrier ensuring that the proxy server monitors all traffic between the Internet and the intranet. This is normally an integral part of security enforcement in corporate firewalls within intranets.

Procedure:

- 1 In the network dialog box, touch a network.

- 2 Touch **Show advanced options** checkbox.
- 3 Touch **Proxy settings** and select **Manual**.

Figure 120: Proxy Settings

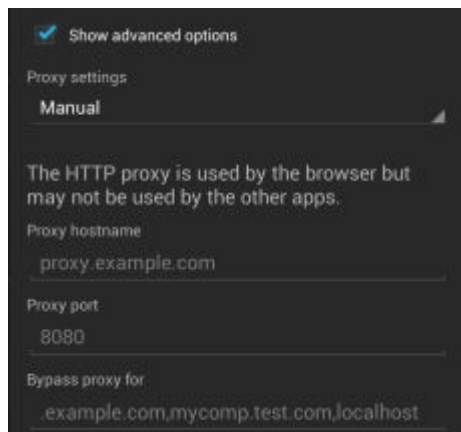

- 4 In the **Proxy hostname** text box, enter the address of the proxy server.
- 5 In the **Proxy port** text box, enter the port number for the proxy server.



Note: When entering proxy addresses the **Bypass proxy for** field, do not use spaces or carriage returns between addresses.

- 6 In the **Bypass proxy for** text box, enter addresses for web sites that do not require to go through the proxy server. Use a comma “,” between addresses.
- 7 Touch **Connect**.
- 8 Touch .

Configuring the Device to Use a Static IP Address

By default, the device is configured to use Dynamic Host Configuration Protocol (DHCP) to assign an Internet protocol (IP) address when connecting to a wireless network. To configure the device to connect to a network using a static IP address:

Procedure:

- 1 In the network dialog box, touch a network.
- 2 Touch **Show advanced options** checkbox.
- 3 Touch **IP settings** and select **Static**.



Figure 121: Static IP Settings

- 4 In the **IP address** text box, enter an IP address for the device.
- 5 If required, in the **Gateway** text box, enter a gateway address for the device.
- 6 If required, in the **Network prefix length** text box, enter a the prefix length.
- 7 If required, in the **DNS 1** text box, enter a Domain Name System (DNS) address.
- 8 If required, in the **DNS 2** text box, enter a DNS address.
- 9 Touch **Connect**.
- 10 Touch .

Advanced Wi-Fi Settings



Note: Advanced Wi-Fi settings are for the device not for a specific wireless network.

Use the **Advanced** settings to configure additional Wi-Fi settings. From the **Wi-Fi** screen, touch  or  > **Advanced** to view the advanced settings.

- **General**

- **Network notification** - When enabled, notifies the user when an open network is available.
- **Keep Wi-Fi on during sleep** - Opens a menu to set whether and when the Wi-Fi radio turns off.
 - + **Always (increases data usage)** - The radio stays on when the device enters suspend mode.
 - + **Only when plugged in** - The radio stays on while the device is connected to external power.
 - + **Never On** - The radio turns off when the device enters suspend mode (default).
- **Install Certificates** – Touch to install certificates. (Only available on Android version 4.4.3 and above)
- **Wi-Fi optimization** – Touch to minimize battery usage when Wi-Fi is on (default – disabled) (Only available on Android version 4.4.3 and above)
- **MAC address** - Displays the Media Access Control (MAC) address of the device when connecting to Wi-Fi networks.
- **IP address** - Displays the IP address of the device when connecting to Wi-Fi networks. (Only available on Android version 4.1.2).

- **Regulatory (Only available on Android version 4.4.3 and above)**

- **Enable 802.11d** - Enabled by default. The device obtains Regulatory information from the AP including country code. Displays the country code acquired from the AP.
- **Enable 802.11d Strict mode** - Device will connect only if the acquired country matches the country broadcasted by the AP.

- **Country selection** - Displays the acquired country code if 802.11d is enabled else it displays the currently selected country code.
- **Region code** - Displays the current region code.
- **Band and Channel Selection (Only available on Android version 4.4.3 and above)**
 - **Wi-Fi frequency band** - Use to select the frequency band. Options: **Auto** (default), **5 GHz only** or **2.4 GHz only**.
 - **Available channels (2.4 GHz)** - Use to select specific channels. Touch to display the **Available channels** menu. Select specific channels. Touch **OK**.
 - **Available channels (5 GHz)** - Use to select specific channels. Touch to display the **Available channels** menu. Select specific channels. Touch **OK**.
- **Logging (Only available on Android version 4.4.3 and above)**
 - **Advanced Logging** - Provides support for continuous capture of system logs to a file to help in debugging and resolution of Wi-Fi related issues. Disabled by default. In the **Advanced Logging** dialog box, select **Enable Logging**. If desired, change the log directory location. When enabled, the following log are captured:
 -  **Note:**
The TC55 must have a microSD card installed.
All log files are saved in `/storage/sdcard0/fusionlogs` on the TC55.
Fusion will ask the user whether he wants to clear out previous logs before starting logging.
tcpdump capture file and `fusion-sysinfo.log` will only be generated when advanced logging is stopped.
 - + Android logcat output with time stamps and the kernel messages in the file: `fusion-wlan.log`.
 - + tcpdump intermediate capture of packets between network stack and driver in the file: `fusion-pktcap.pcap`
 - + Fusion versions, Wi-Fi state machine logs and other framework information in the file: `fusion-sysinfo.log`.
 - **Wireless logs** - Use to capture Wi-Fi log files.
 - + **Fusion Logger** - Touch to open the **Fusion Logger** application. This application maintains a history of high level WLAN events which helps to understand the status of connectivity.

Figure 122: Fusion Logger Screen



- + **Fusion Status** - Touch to display live status of WLAN state. Also provides information of device and connected profile.

Figure 123: Fusion Status Screen

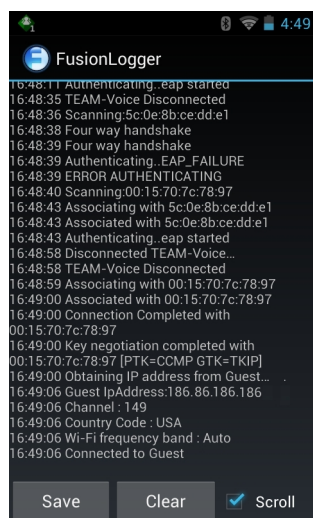
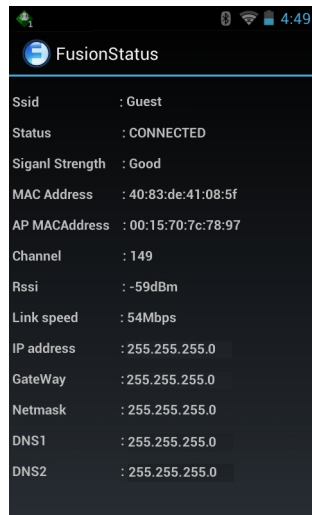

- **About (Only available on Android version 4.4.3 and above)**
 - **Version** - Displays the current Fusion information.

WLAN Configuration



Note: Only available on Android version 4.1.2.





Use the **WLAN Configuration** settings to configure additional WLAN settings. From the **Wi-Fi** screen, touch  > **WLAN Configuration** to view the settings.

- **Country Override** - Check to disable 802.11d. Select the country of operation from the menu.
- **Rate Selection**
 - **Auto Mode (a/b/g/n)** - Use all data rates available (default).
 - **11a/b/g Only** - Use only 802.11 a/b/g.
 - **11n mode Only** - Use only 802.11n.
- **Band Selection**
 - **Auto (2.4GHz and 5GHz)** - Use both the 2.4 GHz and 5 GHz bands (default).
 - **2.4Ghz Only** - Use only the 2.4 GHz band.
 - **5Ghz Only** - Use only the 5 GHz band.
- **Enable Power Saving** - When enabled, the WLAN radio goes into sleep mode when there is no WLAN activity.

Modifying a Wi-Fi Network

The user can change settings and passwords for a network in the Wi-Fi list.

Procedure:







- 1 Touch .
- 2 Touch  or .
- 3 Touch  **Wi-Fi**.
- 4 Slide the Wi-Fi switch to the **On** position.
- 5 Touch and hold on a network name and then touch **Modify network**.
- 6 Modify the network settings and then touch **Save**.

- 7 Touch .

Connecting to a Wi-Fi Network Using WPS

Wi-Fi Protected Setup (WPS) allows users to set up Wi-Fi Protected Access making it easy to add new devices to an existing network without entering long passphrases.





Procedure:

- 1 Touch .
- 2 Touch  or .
- 3 Touch  **Wi-Fi**.
- 4 Slide the Wi-Fi switch to the **On** position.
- 5 Touch .
- 6 On the wireless router, press the WPS button.
The TC55 connects to the wireless router.
- 7 Touch .

Remove a Wi-Fi Network

To remove a remembered or connected network:

Procedure:

- 1 Touch .
- 2 Touch  or .
- 3 Touch  **Wi-Fi**.
- 4 In the **Wi-Fi networks** list, touch and hold the name of the network.
- 5 In the menu, touch **Forget network**.
- 6 Touch .

Bluetooth

Bluetooth-equipped devices can communicate without wires, using frequency-hopping spread spectrum (FHSS) radio frequency (RF) to transmit and receive data in the 2.4 GHz Industry Scientific and Medical (ISM) band (802.15.1). Bluetooth wireless technology is specifically designed for short-range (10 meters (32.8 feet)) communication and low power consumption.

Devices with Bluetooth capabilities can exchange information (e.g., files, appointments, and tasks) with other Bluetooth enabled devices such as printers, access points, and other mobile devices.

Adaptive Frequency Hopping

Adaptive Frequency Hopping (AFH) is a method of avoiding fixed frequency interferers, and can be used with Bluetooth voice. All devices in the piconet (Bluetooth network) must be AFH-capable in order for AFH to work. There is no AFH when connecting and discovering devices. Avoid making Bluetooth connections and discoveries during critical 802.11b communications. AFH for Bluetooth consists of four main sections:

- Channel Classification - A method of detecting an interference on a channel-by-channel basis, or pre-defined channel mask.
- Link Management - Coordinates and distributes the AFH information to the rest of the Bluetooth network.
- Hop Sequence Modification - Avoids interference by selectively reducing the number of hopping channels.
- Channel Maintenance - A method for periodically re-evaluating the channels.

When AFH is enabled, the Bluetooth radio “hops around” (instead of through) the 802.11b high-rate channels. AFH coexistence allows Enterprise devices to operate in any infrastructure.

The Bluetooth radio in this device operates as a Class 2 device power class. The maximum output power is 2.5 mW and the expected range is 10 meters (32.8 ft.). A definition of ranges based on power class is difficult to obtain due to power and device differences, and whether one measures open space or closed office space.



Note: It is not recommended to perform Bluetooth wireless technology inquiry when high rate 802.11b operation is required.

Security

The current Bluetooth specification defines security at the link level. Application-level security is not specified. This allows application developers to define security mechanisms tailored to their specific need. Link-level security occurs between devices, not users, while application-level security can be implemented on a per-user basis. The Bluetooth specification defines security algorithms and procedures required to authenticate devices, and if needed, encrypt the data flowing on the link between the devices. Device authentication is a mandatory feature of Bluetooth while link encryption is optional.

Pairing of Bluetooth devices is accomplished by creating an initialization key used to authenticate the devices and create a link key for them. Entering a common personal identification number (PIN) in the devices being paired generates the initialization key. The PIN is never sent over the air. By default, the Bluetooth stack responds with no key when a key is requested (it is up to user to respond to the key request event). Authentication of Bluetooth devices is based-upon a challenge-response transaction. Bluetooth allows for a PIN or passkey used to create other 128-bit keys used for security and encryption. The encryption key is derived from the link key used to authenticate the pairing devices. Also worthy of note is the limited range and fast frequency hopping of the Bluetooth radios that makes long-distance eavesdropping difficult.

Recommendations are:

- Perform pairing in a secure environment
- Keep PIN codes private and do not store the PIN codes in the device
- Implement application-level security.

Bluetooth Profiles

The TC55 supports the following Bluetooth services:

- Generic Access Profile (GAP) - Use for device discovery and authentication.
- Service Discovery Protocol (SDAP) - Handles the search for known and specific services and general services.
- Serial Port Profile (SPP) - Sets up a virtual serial port and connects two Bluetooth enabled devices. For example, connecting the TC55 to a printer.
- Human Interface Device Profile (HID) - Allows Bluetooth keyboards, pointing devices, gaming devices and remote monitoring devices to connect to the TC55.
- Object Push Profile (OPP) - Allows the TC55 to push and pull objects to and from a push server.
- Hands-Free Profile (HFP) - Allows a hands-free device, such as a Bluetooth headset, to place and receive calls on the TC55.
- Advanced Audio Distribution Profile (A2DP) - Allows the TC55 to stream stereo-quality audio to a wireless headset or wireless stereo speakers.
- Audio/Video Remote Control Profile (AVRCP) - Allows the TC55 to control televisions, hi-fi equipment, etc.

- General Object Exchange Profile (GOEP) - Provides a basis for other data profiles. Based on OBEX and sometimes referred to as such.
- Handsfree Profile (HFP) - Allow car hands-free kits to communicate with mobile phones in the car.
- Personal Area Network (PAN) - Allow the use of Bluetooth Network Encapsulation Protocol on Layer 3 protocols for transport over a Bluetooth link.
- General Audio/Video Distribution Profile (GAVDP) - Provides the basis for A2DP, and VDP.
- PhoneBook Access Profile (PBAP) - Allows exchange of Phone Book Objects between a car kit and a mobile phone to allow the car kit to display the name of the incoming caller; allow the car kit to download the phone book so the user can initiate a call from the car display.

Bluetooth Power States

The Bluetooth radio is off by default.

- **Suspend** - When the TC55 goes into suspend mode, the Bluetooth radio stays on.
- **Airplane Mode** - When the TC55 is placed in Airplane Mode, the Bluetooth radio turns off. When Airplane mode is disabled, the Bluetooth radio returns to the prior state. When in Airplane Mode, the Bluetooth radio can be turned back on if desired.

Bluetooth Radio Power





Turn off the Bluetooth radio to save power or if entering an area with radio restrictions (e.g., an airplane). When the radio is off, other Bluetooth devices cannot see or connect to the device. Turn on the Bluetooth radio to exchange information with other Bluetooth devices (within range). Communicate only with Bluetooth radios in close proximity.



Note: To achieve the best battery life turn off radios when not in use.





Enabling Bluetooth

Procedure:

- 1 Touch .
- 2 Touch  or .
- 3 Slide the Bluetooth switch to the **ON** position.  also appears in the Status bar.
- 4 Touch .

Disabling Bluetooth

Procedure:

- 1 Touch .
- 2 Touch  or .
- 3 Slide the Bluetooth switch to the **OFF** position.
- 4 Touch .

Discovering Bluetooth Device(s)

The TC55 can receive information from discovered devices without pairing. However, once paired, the TC55 and a paired device exchange information automatically when the Bluetooth radio is on. To find Bluetooth devices in the area:

Procedure:





- 1 Ensure that Bluetooth is enabled on both devices.
- 2 Ensure that the Bluetooth device to discover is in discoverable mode.
- 3 Ensure that the two devices are within 10 meters (32.8 feet) of one another.
- 4 Touch .
- 5 Touch  or .
- 6 Touch  **Bluetooth**.
- 7 Touch **SCAN FOR DEVICES**. The TC55 begins searching for discoverable Bluetooth devices in the area and displays them under **AVAILABLE DEVICES**.
- 8 Scroll through the list and select a device. The **Bluetooth pairing request** dialog box appears.

Figure 124: Bluetooth Pairing - Enter PIN

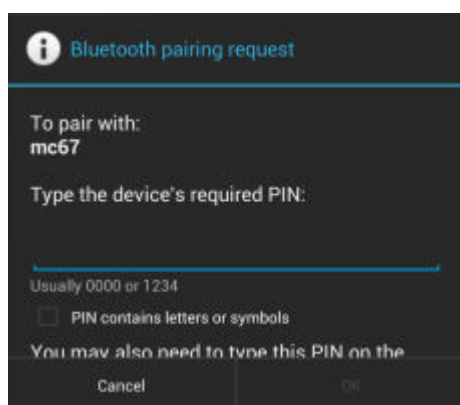
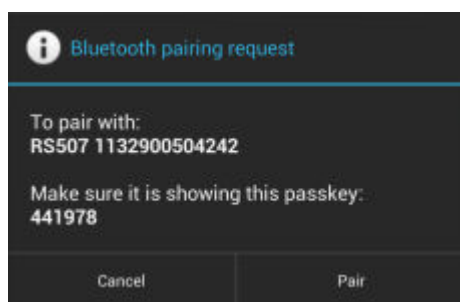

Figure 125: Bluetooth Pairing - Smart Pairing









- 9 Enter a PIN in the text box and touch **OK**. Enter the same PIN on the other device.
- 10 For Simple Pairing, touch **Pair** on both devices.
- 11 The Bluetooth device is added to the **Bluetooth devices** list and a trusted (“paired”) connection is established.

Changing the Bluetooth Name

By default, the TC55 has a generic Bluetooth name that is visible to other devices when connected.





Procedure:

- 1 Touch .
- 2 Touch  or .
- 3 Touch  **Bluetooth**.
- 4 If Bluetooth is not on, slide the switch to the **ON** position.
- 5 Touch .
- 6 Touch **Rename device**.
- 7 Enter a name and touch **Done**.
- 8 Touch .

Connecting to a Bluetooth Device

Once paired, connect to a Bluetooth device.







Procedure:

- 1 Touch .
- 2 Touch  or .
- 3 Touch  **Bluetooth**.
- 4 If Bluetooth is not on, slide the switch to the **ON** position.
- 5 In the **PAIRED DEVICES** list, touch and hold on a unconnected Bluetooth device until a menu appears.
- 6 Touch **Connect**. When connected, the device is displayed as connected in the list.

Selecting Profiles on the Bluetooth Device

Some Bluetooth devices have multiple profiles. To select a profile:

Procedure:





- 1 Touch .
- 2 Touch  or .
- 3 Touch  **Bluetooth**.
- 4 In the **PAIRED DEVICES** list, touch  next to the device name.
- 5 Under **PROFILES**, check or uncheck a profile to allow the device to use that profile.
- 6 Touch .

Unpairing a Bluetooth Device

To unpair a Bluetooth device and erase all pairing information:

Procedure:

- 1 Touch .

- 2 Touch  or .
- 3 Touch  **Bluetooth**.
- 4 In the **PAIRED DEVICES** list, touch  next to the device name.
- 5 Touch **Unpair**.
- 6 Touch .

Pairing with the CS3070

Procedure:

- 1 Press the CS3070 scan button (+) to wake the scanner.
- 2 Press and hold the Bluetooth button (round button) for five seconds. The scanner beeps and the Bluetooth button starts blinking quickly to indicate that the scanner is discoverable by the host.







Note:

HID is the default profile for the CS3070. If this was changed, scan for bar code below.

Figure 126: Bluetooth Keyboard Emulation (HID) Bar Code



- 3 Touch .
- 4 Touch  or .
- 5 Touch  **Bluetooth**.
- 6 Slide the switch to the **ON** position.
- 7 The CS3070 appears in the **Available Devices** list, indicated by its model name and serial number.
- 8 Select the CS3070 from the list.
A dialog box displays the PIN to enter on the CS3070.
- 9 With the CS3070, scan the PIN using the Numeric Bar Codes. See [CS3070 Numeric Bar Codes for PIN Entry on page 144](#) and then scan **Enter**. The scanner beeps to indicate it has paired with the device, and the device displays **Connected** below the CS3070 device name.

CS3070 Numeric Bar Codes for PIN Entry

Use the following bar codes for pin entry for Bluetooth connection.



0



1

Table continued...



Pairing the RS507 Hands-Free Imager Using SSI

An RS507 Hands-free Imager can be used with the device to capture bar code data.

Procedure:





- 1 Ensure that the two devices are within 10 meters (32.8 feet) of one another.
- 2 Install the battery into the RS507.
- 3 On the TC55, touch .
- 4 Touch .

Figure 127: Bluetooth Pairing Utility

- 5 Using the RS507, scan the bar code on the screen.
The RS507 emits a high/low/high/low beeps. The Scan LED flashes green indicating that the RS507 is attempting to establish connection with the TC55. When connection is established, the Scan LED turns off and the RS507 emits one string of low/high beeps.
- 6 On the TC55, touch .



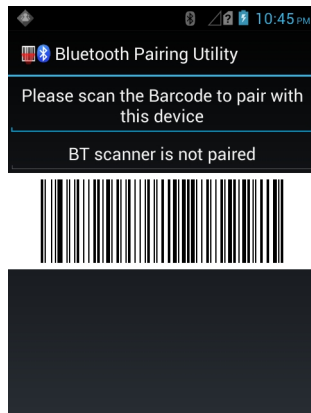

Pairing the RS507 Hands-Free Imager

An RS507 Hands-free Imager can be used with the device to capture bar code data.

Procedure:

- 1 Ensure that Bluetooth is enabled on both devices.
- 2 Ensure that the Bluetooth device to discover is in discoverable mode.
- 3 Ensure that the two devices are within 10 meters (32.8 feet) of one another.
- 4 Place the RS507 in Human Interface Device (HID) mode. If the RS507 is already in HID mode, skip to step 5.
 - a Remove the battery from the RS507.
 - b Press and hold the Restore key.
 - c Install the battery onto the RS507.
 - d Keep holding the Restore key for about five seconds until a chirp is heard and the Scan LEDs flash green.
 - e Scan the bar code below to place the RS507 in HID mode.

Figure 128: RS507 Bluetooth HID Bar Code

- 5 Touch .
- 6 Touch  or .
- 7 Touch  **Bluetooth**.
- 8 Touch **SCAN FOR DEVICES**. The device begins searching for discoverable Bluetooth devices in the area and displays them under **AVAILABLE DEVICES**.
- 9 Scroll through the list and select RS507.
The device connects to the RS507 and **Connected** appears below the device name. The Bluetooth device is added to the **Bluetooth devices** list and a trusted (“paired”) connection is established.

Near Field Communications

NFC/HF RFID is a short-range wireless connectivity technology standard that enables secure transaction between a reader and a contactless smartcard. The technology is based on ISO/IEC 14443 type A and B (proximity) and ISO/IEC 15693 (vicinity) standards, using the HF 13.56 MHz unlicensed band. The TC55n support the following operating modes:

- Reader mode
- Peer-to-Peer communication
- Card Emulation mode.

Using NFC, the TC55 can:

- Exchange data with another NFC device.
- Read information from supported medical sensors.
- Pair with supported Bluetooth devices such as printers and headsets.
- Read contactless cards such as contactless tickets, ID cards and ePassport.
- Read and write information to contactless cards such as SmartPosters and tickets, as well as devices with NFC interface such as vending machines.
- Emulate contactless card such as payment, ticket or SmartPoster (UICC Card Emulation available on all Android versions. Host Card Emulation available on Android version 4.4.3 only).

The TC55 NFC antenna is located at the bottom of the battery cover indicated by an antenna icon.

Sharing Information Using NFC

You can beam content like a web page, contact cards, pictures, YouTube links or location information from your screen to another device by bringing the devices together back to back.

Prerequisites: Make sure both devices are unlocked, support NFC, and have both NFC and Android Beam turned on.

Procedure:

- 1 Open a screen that contains a web page, video, photo or contact.
- 2 Move the back of the TC55 toward the back of the other device.

Figure 129: Sharing Data Using NFC

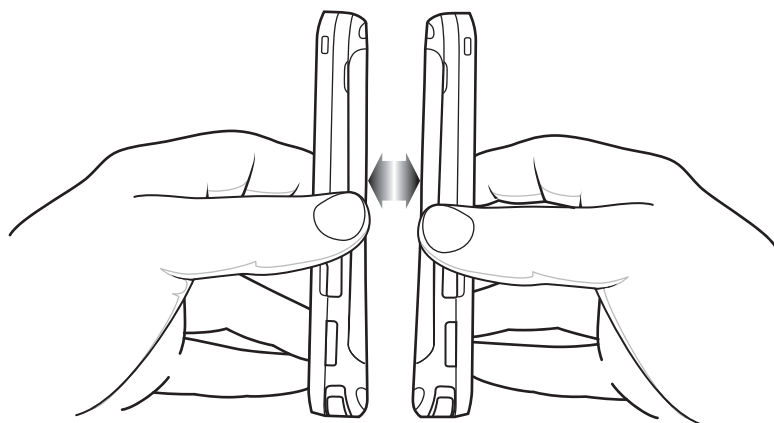

When the devices connect, you hear a sound, the image on the screen reduces in size, the message **Touch to beam** appears.

- 3 Touch anywhere on the screen.
The transfer begins.

Communication Using NFC

Procedure:

- 1 Launch an NFC enabled application.
- 2 Hold TC55 as shown. Do not cover antenna area on battery cover.

Figure 130: Communication with NFC Chip, Tag or Card

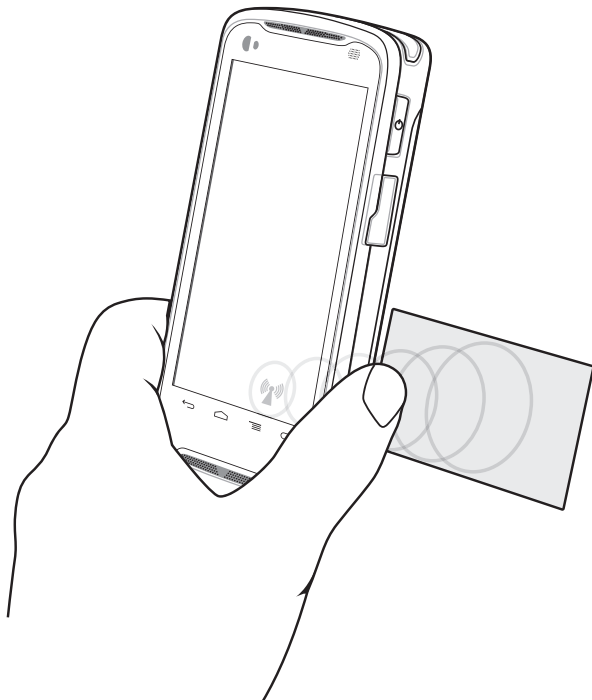

- 3 Move TC55 close to the NFC chip, tag or card until data transfer is complete (usually indicated by the application).

Pairing with NFC Enabled Bluetooth Devices

Prerequisites: Ensure that the NFC-enabled Bluetooth devices is on and in discoverable mode. See the devices user documentation.

Procedure:

- 1 Hold TC55 as shown. Do not cover antenna area on battery cover.

Figure 131: Pairing with NFC Enabled Device

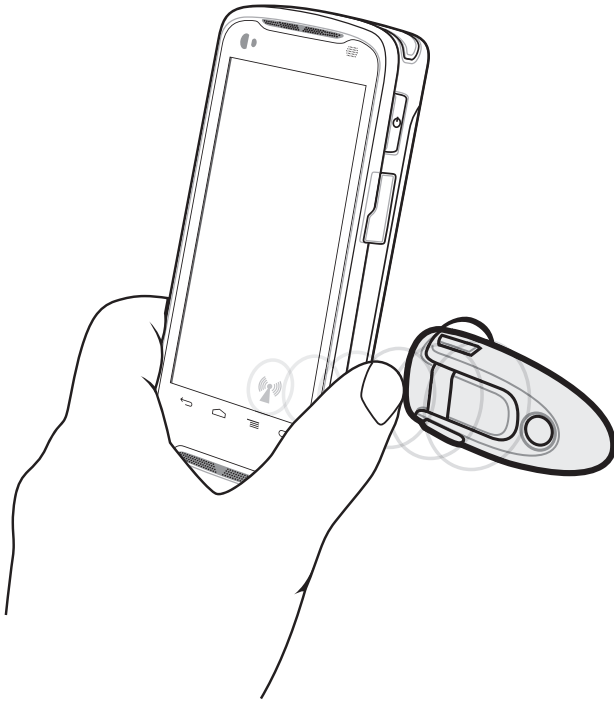

- 2 Move TC55 to close to the device. The device indicates that pairing is successful.

Enterprise NFC Settings



Note: Only available on Android version 4.4.3.

The Enterprise NFC Settings provides advanced configuration of the NFC radio.

To configure the NFC settings, touch **Settings > More ... > Enterprise NFC Settings**.

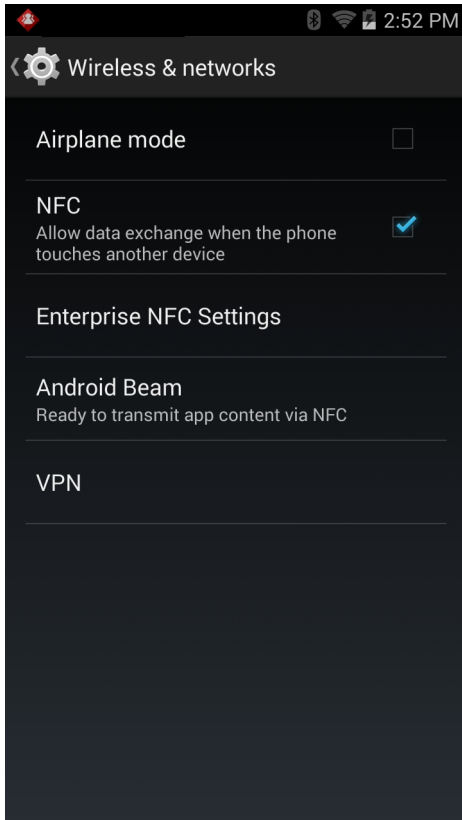
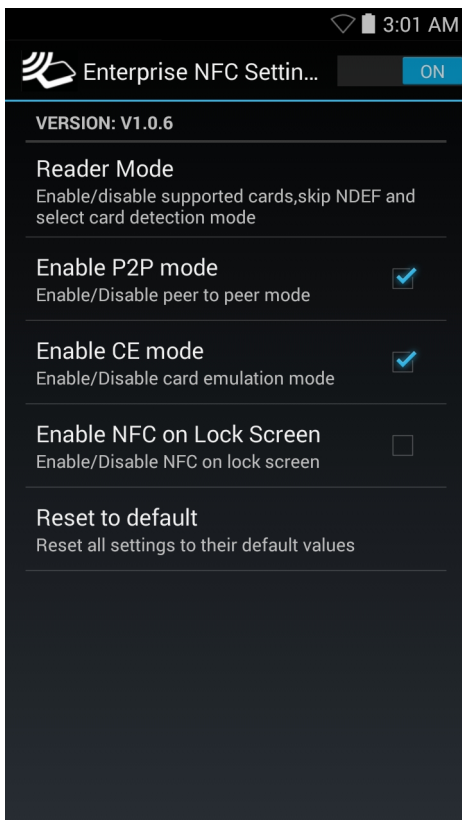
Figure 132: Wireless & Networks Screen**Figure 133: Enterprise NFC Settings Screen**

- **Reader Mode** – Touch to open the Reader Mode setting screen.
- **Enable P2P mode** – Enable or disable peer to peer mode. Default: Enabled.
- **Card Emulation Mode** – Enable or disable card emulation mode. Default: Disabled.
- **Enable CE mode** – Touch to enable or disable card emulation mode. Default: Enabled.
- **Enable NFC on Lock Screen** – Enable or disable NFC on lock screen.
- **Reset to Default** – Reset all NFC settings to factory default settings.

Reader Mode

Use the **Reader Mode** settings to configure the NFC radio.

Figure 134: Reader Mode Settings

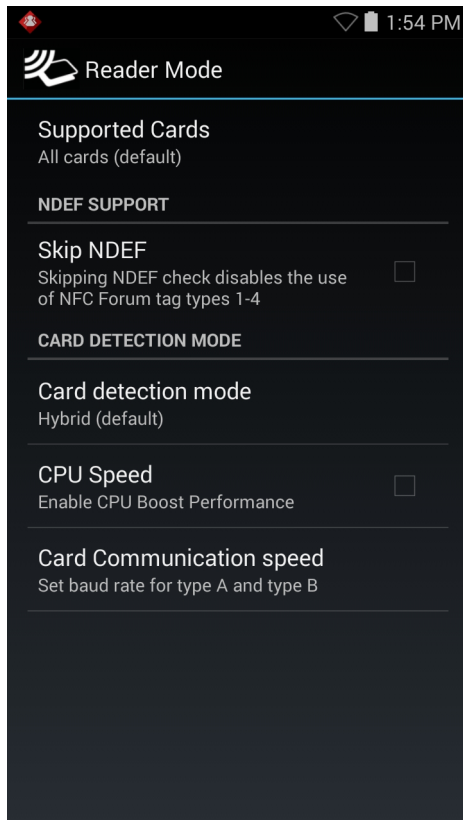

- **Supported Cards** – Touch to select the type of NFC cards to support. Options: **All Cards** (default), **Type A**, **Type B**, **Type F** or **Type V**.
- **NDEF Support**
 - **Skip NDEF** – Enables or disables the use of NFC Forum tag types 1 through 4. Default: Disabled.
- **Card Detection Mode**
 - **Card detection mode** – Touch to select the card detection mode. Options: **Low power**, **Standard** or **Hybrid** (default).
 - **CPU Speed** – Touch to enhance NFC transaction performance while reading small amounts data. Default: Disabled.
 - **Card Communication speed** – Touch to set the baud rate for type A and type B cards. Options: **106 kbps** (default for Type A), **212 kbps**, **424 kbps** or **No restrictions** (default for Type B).

Chapter 7

Accessories

This chapter provides information for using the accessories for the device.

TC55 Accessories

The table below lists the accessories available for the TC55.

Table 11: TC55 Accessories

Accessory	Part Number	Description
Cradles		
Five Slot Charge Only Cradle	CRDUNIV-55-5000R	Provides charging for up to five TC55 devices. Requires additional power supply.
Five Slot Charge Only Cradle Base	CRDUNIV-XX-5000R	Provides charging for up to five TC55 devices. Requires charging cups and additional power supply.
Vehicle Cradle	CRD-TC55-VCD1-01	Provides mounting of the TC55 in a vehicle.
Chargers		
Power Supply (12 VDC, 4.16 A.)	PWRS-14000-148R	Provides power to the Five Slot Charge Only Cradle.
Power Supply (5 VDC, 1.2 A)	PWRS-124306-01R	Provides power to the TC55.
Cables		
Rugged Charge Cable	CBL-TC55-CHG1-01	Provides power to the TC55.
Micro USB Cable	25-MCXUSB-01R	Provides USB communication with a host computer.
Auto Charge Cable	VCA400-01R	Charges the TC55 in a Vehicle Cradle using a vehicle's cigarette lighter.
US AC Line Cord (3-wire)	50-16000-221R	Provides power to the power supplies.
International AC line Cord	-	Provides power to the power supplies. Purchase separately.
Miscellaneous		
Spare 2,940 mAh lithium-ion battery	BTRY-TC55-29MA1-01	Replacement 2,940 mAh battery.

Table continued...

Accessory	Part Number	Description
Spare 4,410 mAh lithium-ion battery	BTRY-TC55-44MA1-01	Replacement 4,410 mAh battery.
2,940 mAh Battery Cover	KT-TC55-29BTYD1-01	Replacement battery cover for 2,940 mAh battery.
4,410 mAh Battery Cover	KT-TC55-44BTYD1-01	Replacement battery cover for 4,410 mAh battery.
Charging Cup	CUPTC55XX-1000R	Mounts onto the Multi Slot Charge Only Cradle Base and provides TC55 charging slot.
Blank Slot Cover	CUPUNICVR-5000R	Mounts on the Five Slot Charge Only Cradle and covers a slot when a cup is not required (5-pack).
Protective Boot (Blue/Black)	SG-TC55-BOOT1-01	Provides additional protection for the TC55.
Protective Boot (Grey/Black)	SG-TC55-BOOT2-01	Provides additional protection for the TC55.
Stylus for Protective Boot	KT-TC55-STYLUS1-01 KT-TC55-STYLUS1-03	Single stylus for Protective Boot with tether. Stylus for Protective Boot with tether (3-pack).
Handstrap	SG-TC55-HSTRPH-01	Attached to Protective boot.
Holster	SG-TC55-HLSTR1-01	Mounts on belt and provides storage for the TC55.

Micro USB Cable

Use the Micro USB Cable to provide USB communication with a host computer.

When the TC55 is connected to a host computer using the Micro USB Cable, the TC55 appears as a Removable Disk on the host computer. Refer to the *TC55 Integrator Guide* for more information.

Figure 135: Using the Micro USB Cable

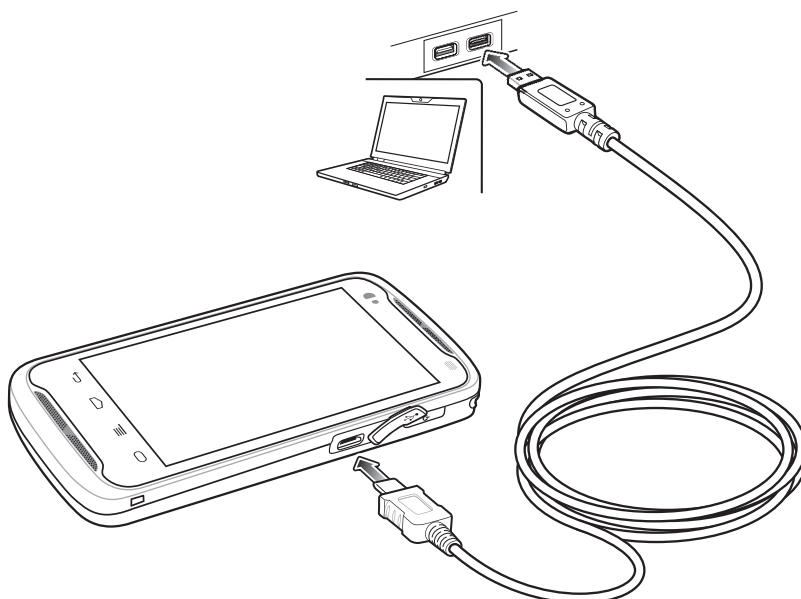



Note: The preferred method to charge the TC55 is to use the Rugged Charge Cable. You can also use the Micro USB Cable to charge the TC55 but the time to fully charge the battery will increase.

Rugged Charge Cable

Use the Rugged Charge Cable to provide power to the TC55.



Note:

Do not connect the Rugged Charge Cable to the USB port of a host computer. The TC55 will not charge from the host computer using the Rugged Charge Cable.

Use Zebra power supply, p/n, PWRS-124306-01R with Rugged Charge Cable.

Figure 136: Rugged Charge Cable

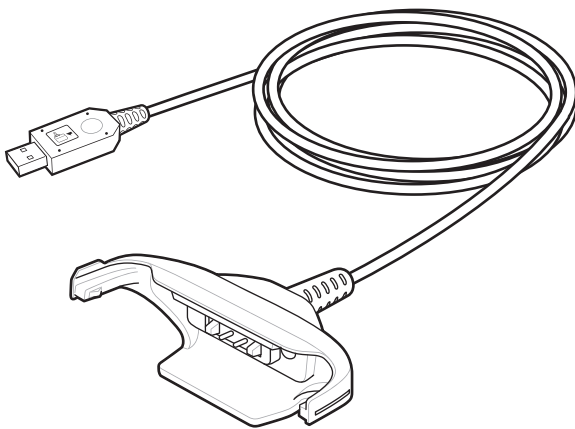

Rugged Charge Cable Setup

Figure 137: Connect Rugged Charge Cable to TC55

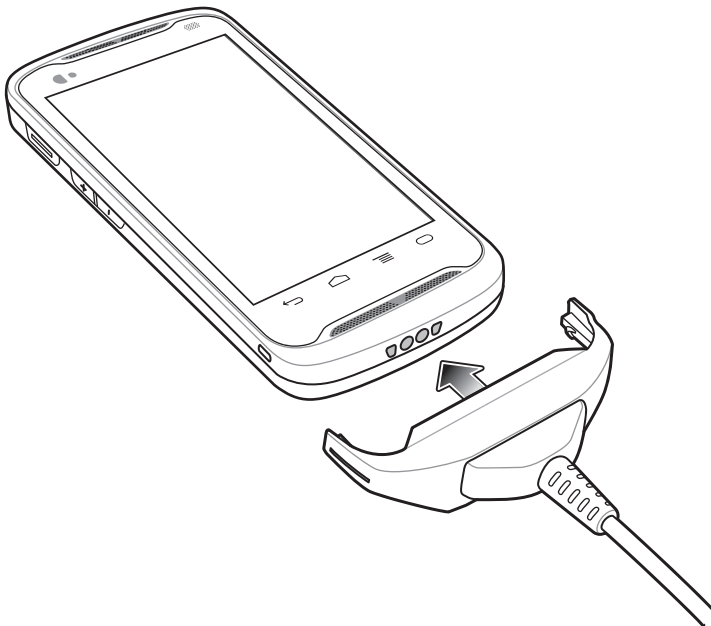
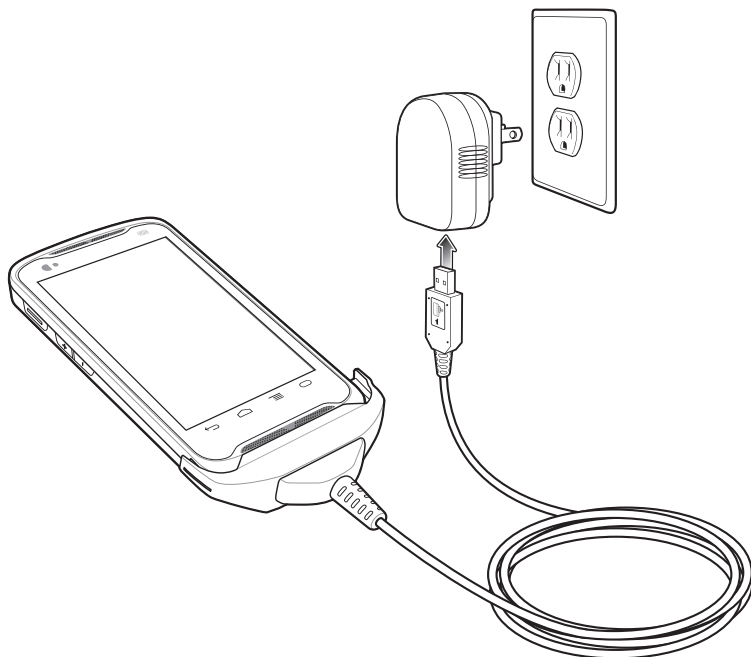
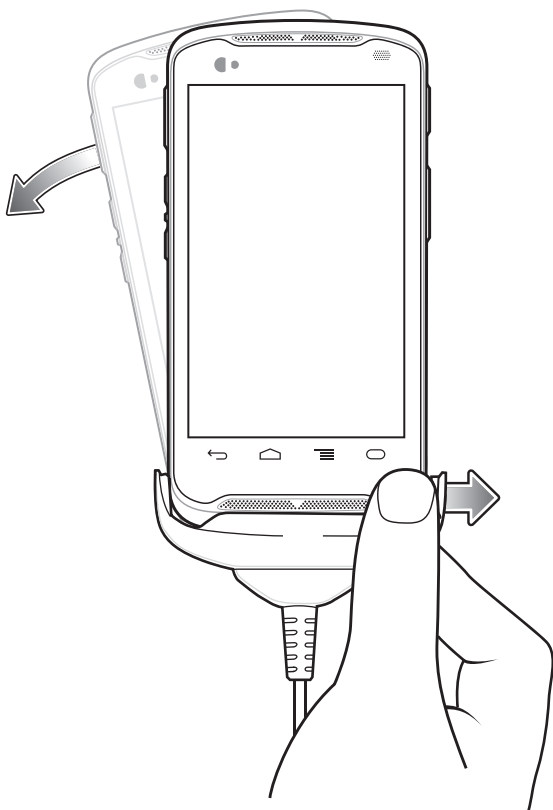

Figure 138: Connect to Power



Rugged Charge Cable Removal

Figure 139: Removing the Rugged Charge Cable



Five Slot Charge Only Cradle

The Five Slot Charge Only cradle:

- Provides 5 VDC power for operating the TC55.
- Simultaneously charges up to five TC55s.
- Consists of a cradle base and optional cups.

Refer to the *TC55 Integrator Guide* for setup and configuration instructions.

Charging the TC55

To charge the TC55, insert the TC55 into an open slot.

Figure 140: Five Slot Charge Only Cradle

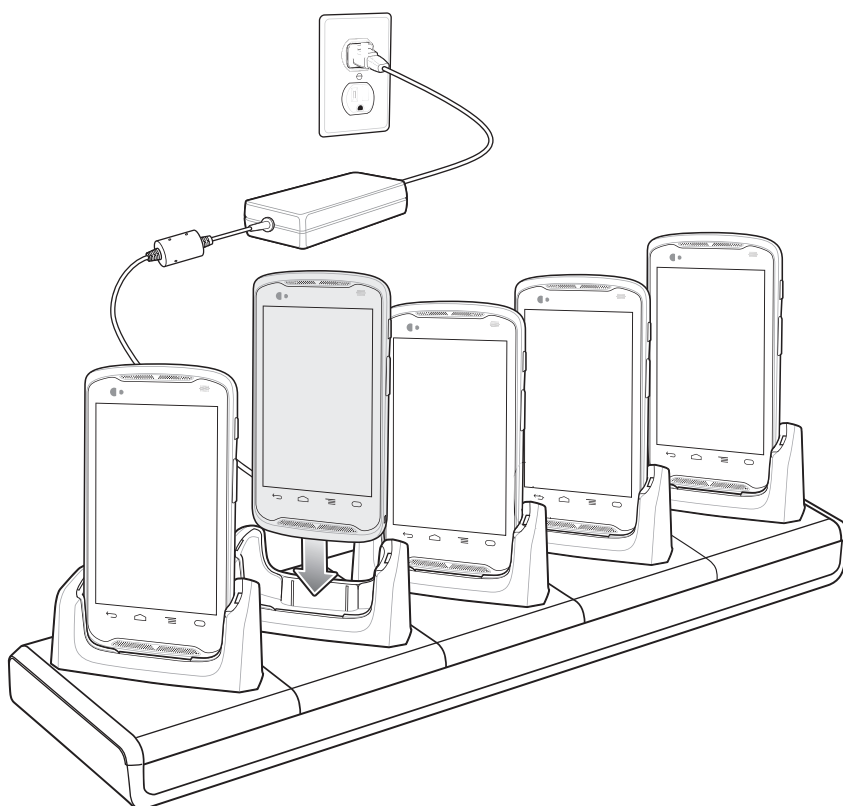

The TC55's LED shows the status of the battery charging. See [Battery Charge LED Status](#) for charging status indications. The 2,940 mAh battery charges in approximately three hours and the 4,410 mAh battery charges in approximately 4.5 hours.

A Charge LED is provided for each battery charging well. See [Charging LED Status on page 30](#) for charging status indications.

Charge batteries in temperatures from 0 °C to 40 °C (32 °F to 104 °F). Charging is intelligently controlled by the charger in order to ensure safe operation and optimize long-term battery life. To accomplish this, for small periods of time, the charger alternately enables and disables battery charging to keep the battery at acceptable temperatures. The charger indicates when charging is disabled due to abnormal temperatures via the LED.

Inserting a TC55 with Boot into Cradle

Each cradle cup has an insert that must be removed prior to inserting the TC55 with Protective Boot. Remove the insert and then insert the TC55 into the cup.

Figure 141: Remove Cup Insert

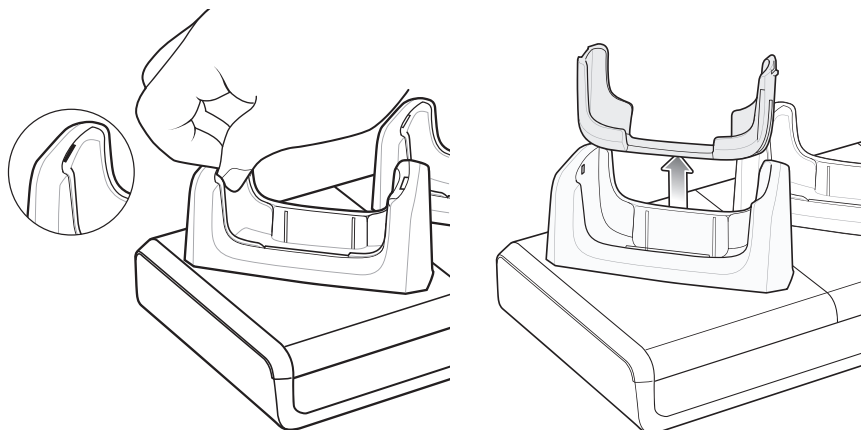

Vehicle Charge Cradle



Warning: Some countries prohibit the mounting of any electronic device in any location on the vehicle dashboard. Be sure to check with local laws acceptable mounting areas before installing the auto mounting kit.

Install the vehicle mount on the surface of the vehicle that is reasonably flat and free of dirt and oil. Clean the mounting surface with a glass cleaner and a clean cotton cloth. Install the vehicle mount on the windshield or other flat car surface using the supplied mounting disc.

The TC55 can detect when it is inserted into the cradle. Use the Dock settings to configure the TC55 when in the cradle. See the *TC55 Integrator Guide* for more information.

You can place the TC55 in the cradle either with or without the protective boot.

Installing Vehicle Cradle on Windshield

Procedure:

- 1 Fix the suction cup mount to the selected area with the suction lever facing up.

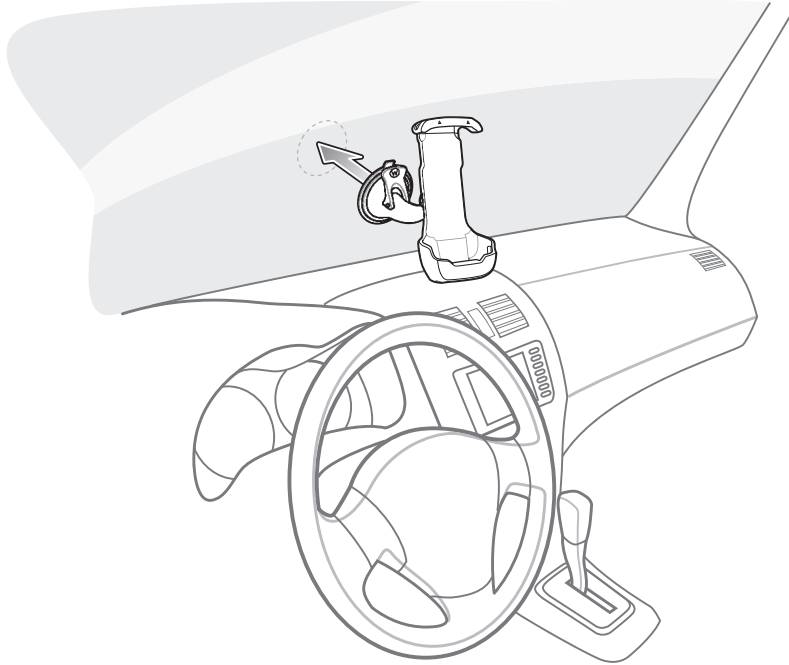
Figure 142: Windshield Installation

- 2 Flip the lever down to create a vacuum between the suction cup and the mounting surface.

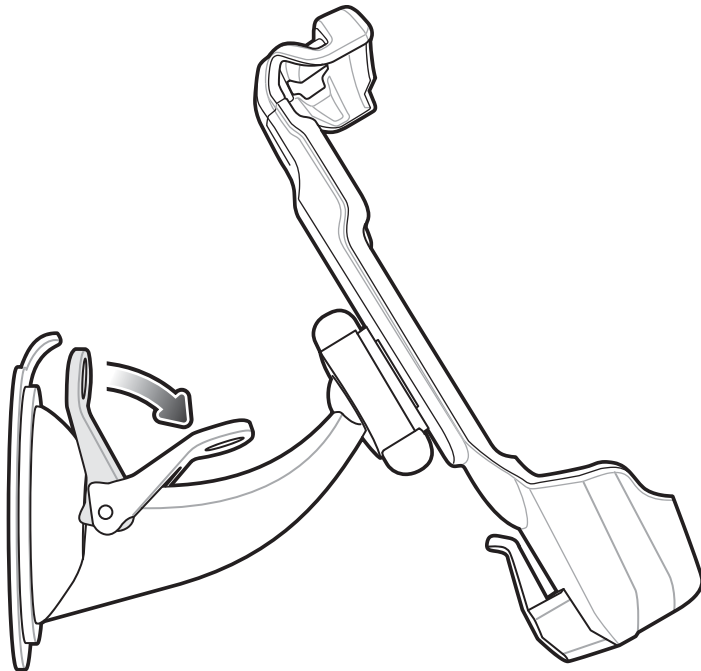
Figure 143: Move Level Toward Windshield

- 3 Make sure that the suction bond is strong enough before proceeding to the next step.
- 4 Place the TC55 top first into the cradle and push up.
- 5 Rotate the bottom into the cradle and place in the bottom of the cradle.

Figure 144: Insert TC55 into Vehicle Charge Cradle

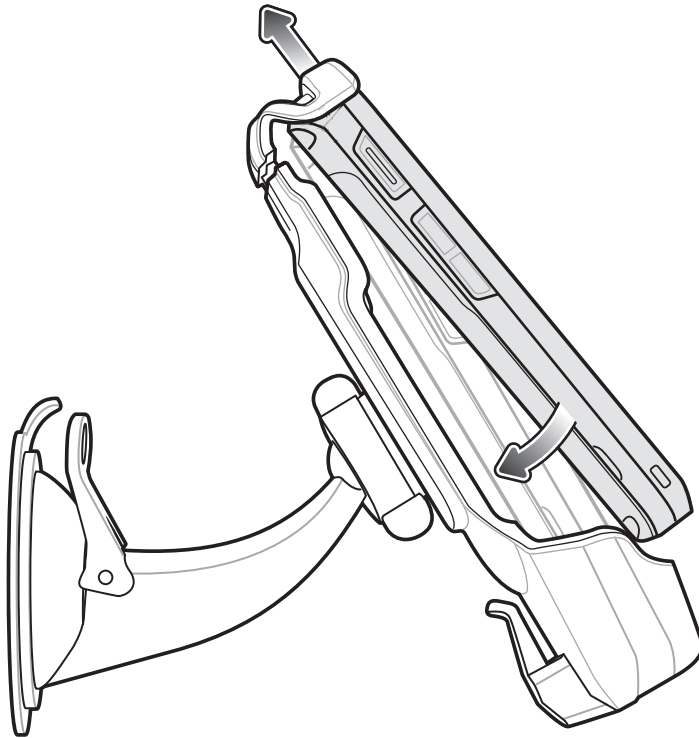

Note: When the TC55 is installed in the vehicle cradle, it automatically detects the insertion and goes into Car Mode, by default.

- 6 Position the TC55 for best viewing.
- 7 Tighten the nuts to lock the cradle in place.

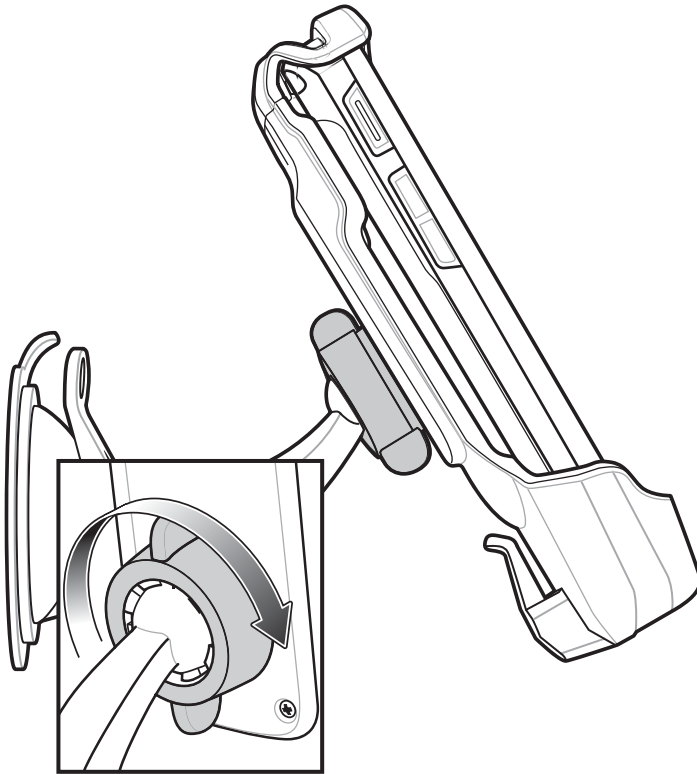
Figure 145: Tighten Nut

- 8 In order to charge the TC55 while in a vehicle, connect the micro USB connector of the auto charge cable (p/n VCA400-01R) to the input power connector in the Vehicle Charge Cradle.

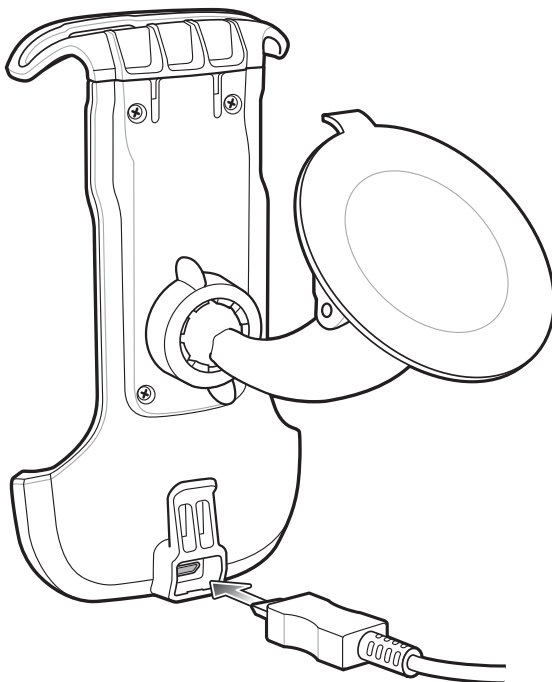
Figure 146: Connect Auto Charge Cable to Vehicle Charge Cradle

- 9 Use the cable retention feature to secure the cable.

Figure 147: Cable Retention

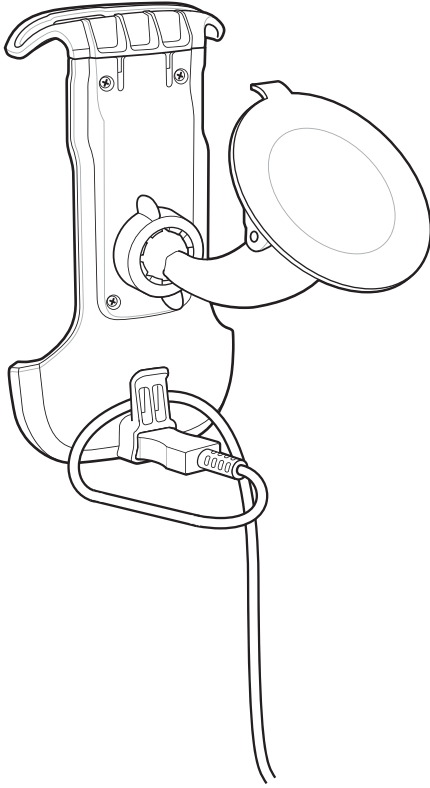

10 Connect the other end to the vehicle power outlet. The LED indicator flashes green indicating the TC55 is charging.

Removing the Device from the Vehicle Cradle

Procedure:

- 1 Lift the TC55 up.

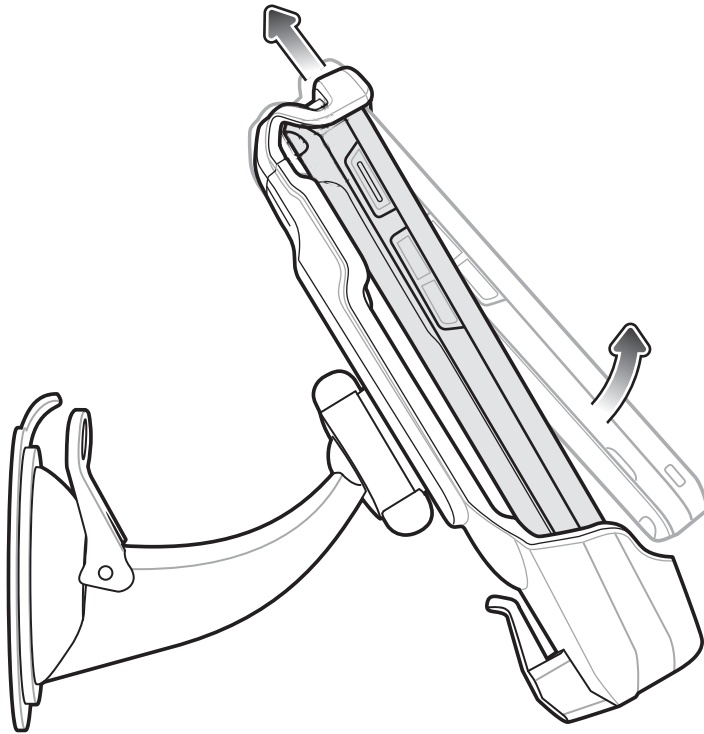
Figure 148: Remove TC55 From Vehicle Cradle

2 Remove bottom of TC55 from the cradle

Dock Settings

Use the Dock Settings to set specific device settings when the TC55 is inserted into the Vehicle Cradle.

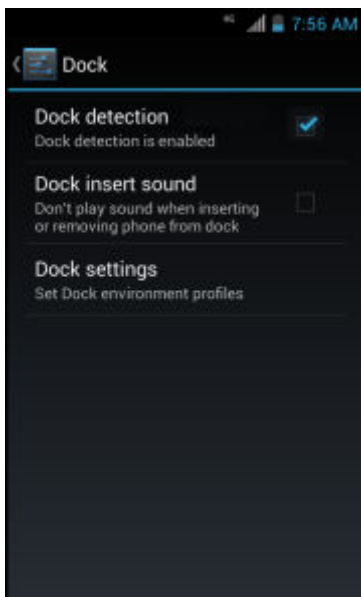
Figure 149: Dock Screen

- **Dock detection** - Check to enable the detection of the TC55 when placed into the Vehicle Cradle. Enabled by default.
- **Dock insert sound** - Check to play a sound when the TC55 is placed in or removed from the Vehicle Cradle.

- **Dock settings** - Touch to modify the TC55 settings when placed in the cradle.

Figure 150: Dock Settings Screen

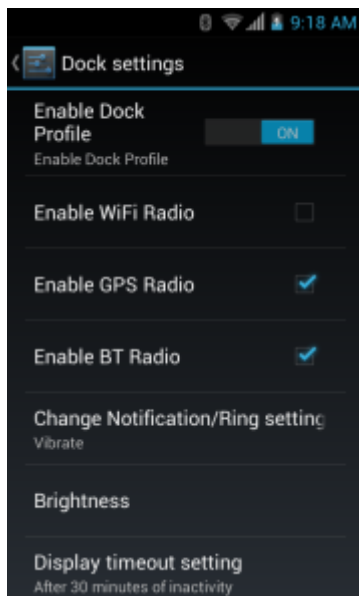

- **Enable Dock Profile** - Slide switch to enable or disable dock settings when the TC55 is in the Vehicle Cradle.
- **Enable Wi-Fi Radio** - Enable or disable the Wi-Fi radio when the TC55 is in the Vehicle Cradle.
- **Enable GPS Radio** - Enable or disable the GPS radio when the TC55 is in the Vehicle Cradle.
- **Enable BT Radio** - Enable or disable the Bluetooth radio when the TC55 is in the Vehicle Cradle.
- **Change Notification/Ring setting** - Select notification that occurs when the TC55 is in the Vehicle Cradle. Options: **Play Sound** or **Vibrate**.
- **Brightness** - Set the screen brightness when the TC55 is in the Vehicle Cradle.
- **Display timeout setting** - Set the amount of time before the screen turns off when the TC55 is in the Vehicle Cradle.
- **Touchscreen mode**- Select touch screen mode when the TC55 is in the Vehicle Cradle. Options: **Finger/Gloved** or **Finger/Stylus**.
- **Launch an installed application** - Select an application that launches when the TC55 is inserted into the cradle.

Installing the Protective Boot

Figure 151: Protective Boot

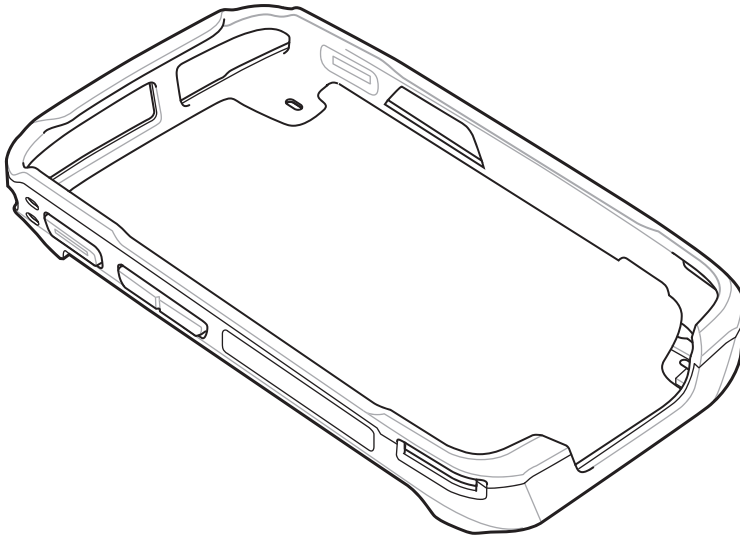

Procedure:

- 1 Insert the top of the TC55 into the top of the Protective Boot.

Figure 152: Insert Top of TC55 into Boot

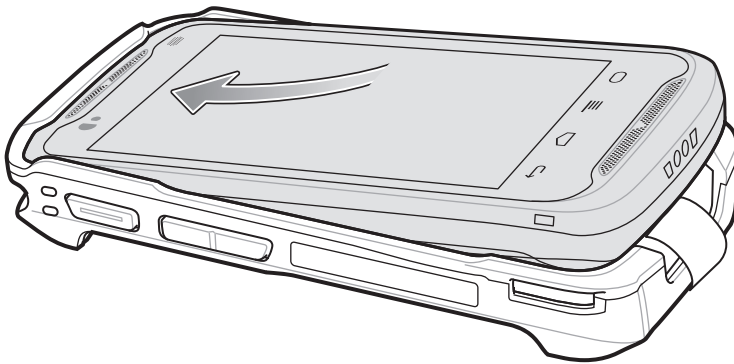

- 2 Rotate the bottom of the TC55 into the protective Boot.

Figure 153: Insert Bottom of TC55 into Boot

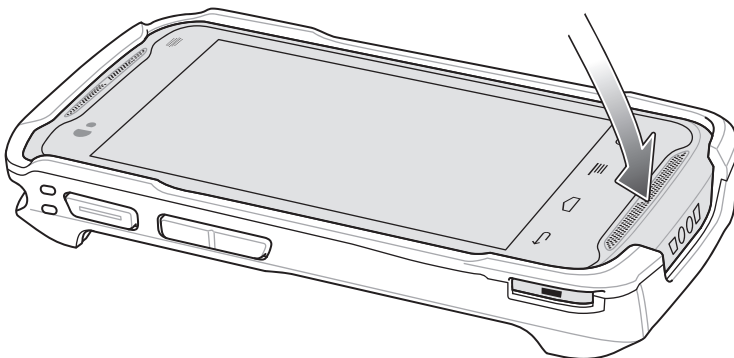

- 3 Ensure that the Protective Boot is properly fitted on the TC55.

Attaching the Stylus to the Protective Boot

Procedure:

- 1 Insert one end of the tether into the hole in the stylus.

Figure 154: Insert Tether into Stylus

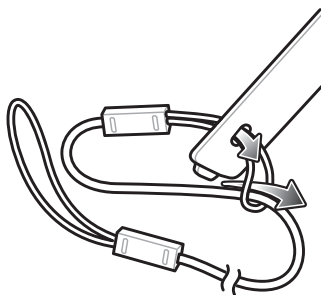

- 2 Feed the other end of the tether through the first loop.
- 3 Pull the tether taut.
- 4 Feed the loose end of the tether through the tether hole in the Protective Boot.

Figure 155: Feed Stylus through Tether Loop

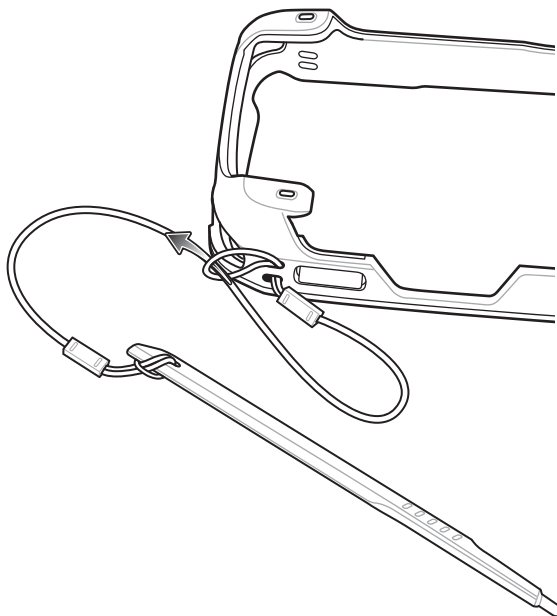

- 5 Feed the stylus through the tether loop.
- 6 Pull the tether taut.
- 7 Insert the point of the stylus into the mounting hole in the boot.

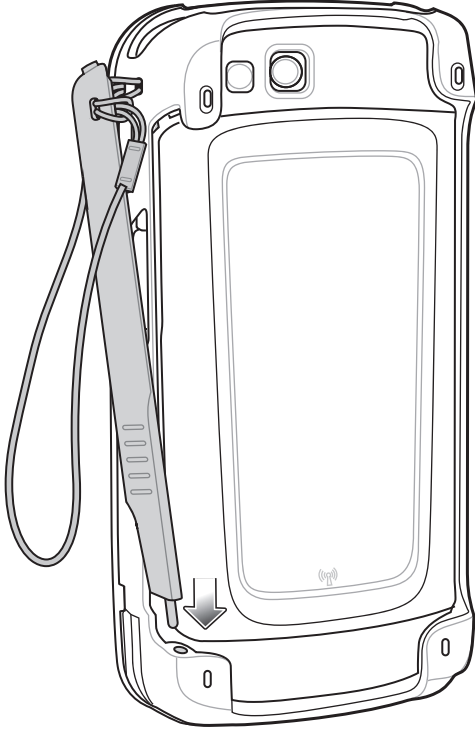
Figure 156: Insert Stylus Point into Mounting Hole

8 Rotate the stylus into the boot.

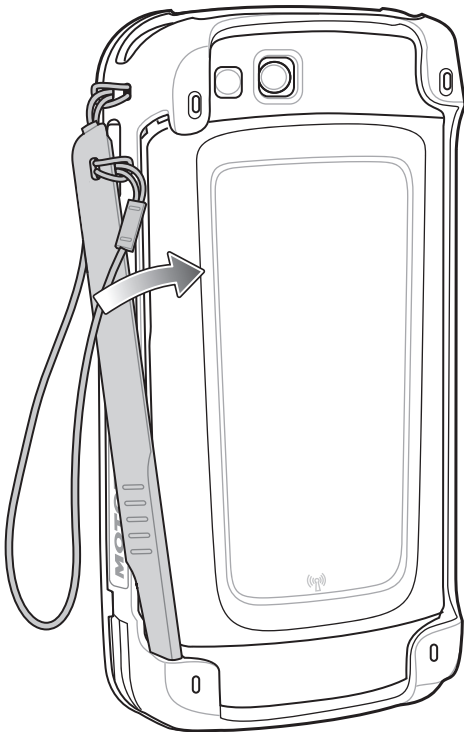
Figure 157: Lock Stylus into Place

9 Ensure that the top of the stylus snaps into the boot.

Figure 158: Style in Protective Boot

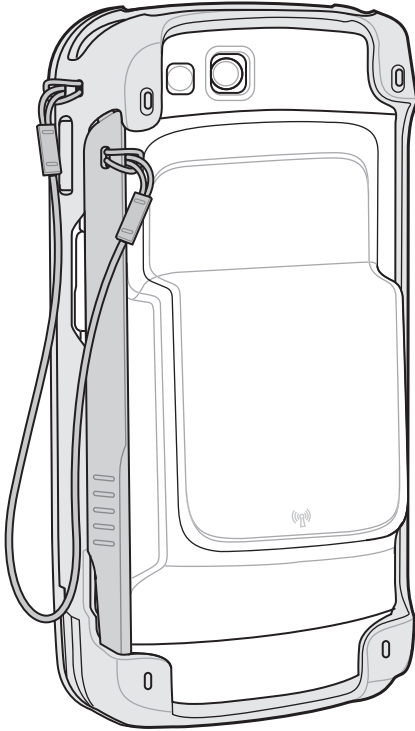

Holster

Use the holster to securely carry the TC55 when working.

Figure 159: Holster

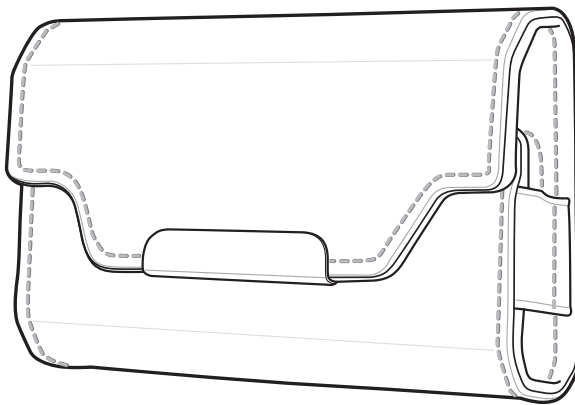

Insert the TC55 with the 2,490 mAh battery into the holster with the screen facing in or out.

Figure 160: Inserting the TC55 with 2,490 mAh Battery into the Holster

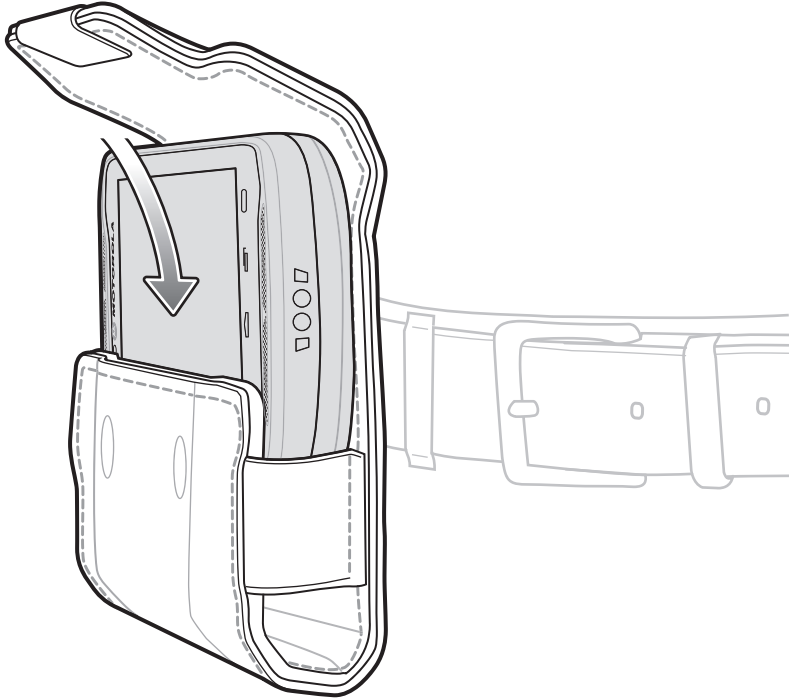

Insert the TC55 with the 4,410 mAh battery into the holster with the screen facing in.

Figure 161: Inserting the TC55 with 4,410 mAh Battery into the Holster

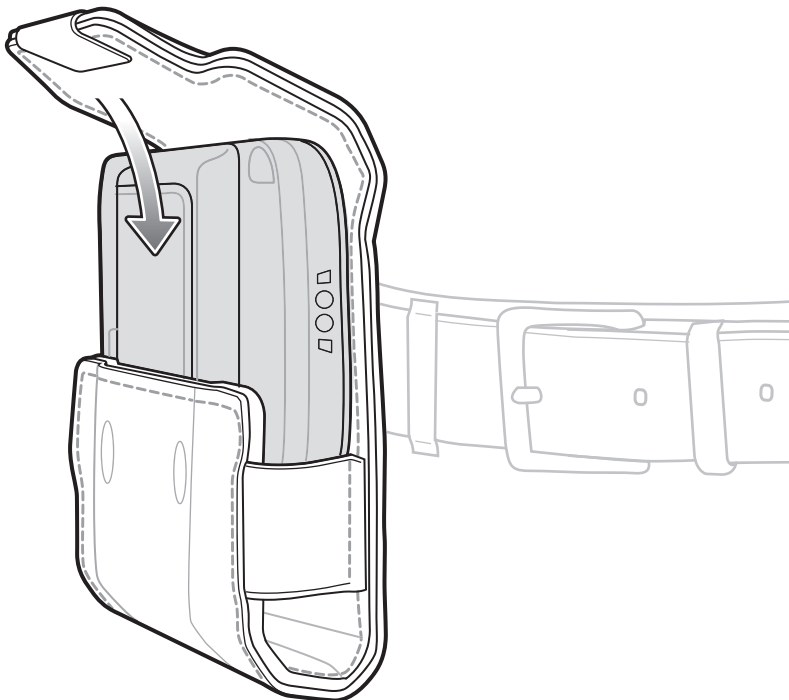

The holster provides a sleeve for holding an optional stylus.



Note: Do not place the stylus into the holder when the TC55 with the Protective Boot is in the holster.

Figure 162: Stylus in Holster

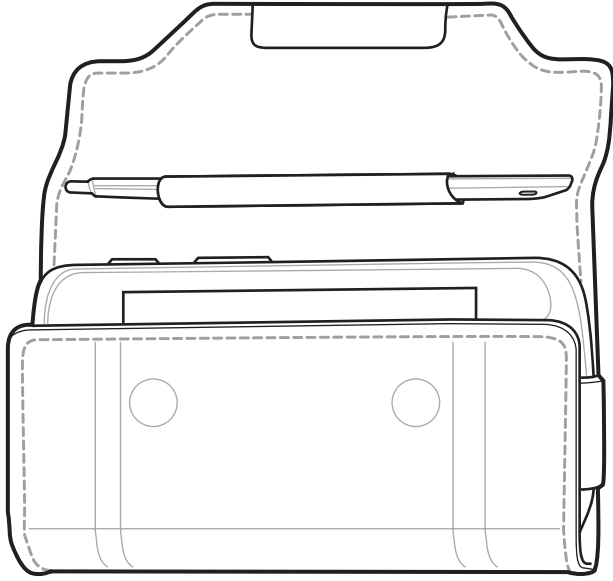

Chapter

8

Maintenance and Troubleshooting

This chapter includes instructions on cleaning and storing the device, and provides troubleshooting solutions for potential problems during operation.

Maintaining the TC55

For trouble-free service, observe the following tips when using the TC55:

- Do not scratch the screen of the TC55. When working with the TC55, use a finger, glove or approved stylus or pen intended for use with a capacitive touch-sensitive screen. Never use an actual pen or pencil or other sharp object on the surface of the TC55 screen.
- The touch-sensitive screen of the TC55 is glass. Do not drop the TC55 or subject it to strong impact.
- Protect the TC55 from temperature extremes. Do not leave it on the dashboard of a car on a hot day, and keep it away from heat sources.
- Do not store or use the TC55 in any location that is dusty, damp, or wet.
- Use a soft lens cloth to clean the TC55. If the surface of the TC55 screen becomes soiled, clean it with a soft cloth moistened with isopropyl alcohol.
- Periodically replace the rechargeable battery to ensure maximum battery life and product performance. Battery life depends on individual usage patterns.

Battery Safety Guidelines

- The area in which the units are charged should be clear of debris and combustible materials or chemicals. Particular care should be taken where the device is charged in a non commercial environment.
- Follow battery usage, storage, and charging guidelines found in this guide.
- Improper battery use may result in a fire, explosion, or other hazard.
- To charge the mobile device battery, the battery and charger temperatures must be between +32 °F and +104 °F (0 °C and +40 °C)
- To charge the mobile device battery, the battery and charger temperatures must be between 0 °C and +45 °C (+32 °F and +113 °F)
- Do not use incompatible batteries and chargers. Use of an incompatible battery or charger may present a risk of fire, explosion, leakage, or other hazard. If you have any questions about the compatibility of a battery or a charger, contact the Global Customer Support Center.
- For devices that utilize a USB port as a charging source, the device shall only be connected to products that bear the USB-IF logo or have completed the USB-IF compliance program.
- To enable authentication of an approved battery, as required by IEEE1725 clause 10.2.1, all batteries will carry a hologram. Do not fit any battery without checking it has the authentication hologram.
- Do not disassemble or open, crush, bend or deform, puncture, or shred.
- Severe impact from dropping any battery-operated device on a hard surface could cause the battery to overheat.
- Do not short circuit a battery or allow metallic or conductive objects to contact the battery terminals.

- Do not modify or remanufacture, attempt to insert foreign objects into the battery, immerse or expose to water or other liquids, or expose to fire, explosion, or other hazard.
- Do not leave or store the equipment in or near areas that might get very hot, such as in a parked vehicle or near a radiator or other heat source. Do not place battery into a microwave oven or dryer.
- Battery usage by children should be supervised.
- Please follow local regulations to properly dispose of used re-chargeable batteries.
- Do not dispose of batteries in fire.
- In the event of a battery leak, do not allow the liquid to come in contact with the skin or eyes. If contact has been made, wash the affected area with large amounts of water and seek medical advice.
- If you suspect damage to your equipment or battery, contact the Customer Support to arrange for inspection.

Cleaning Instructions



Caution:

Always wear eye protection.

Read warning label on compressed air and alcohol product before using.

If you have to use any other solution for medical reasons please contact Zebra for more information.



Warning: Avoid exposing this product to contact with hot oil or other flammable liquids. If such exposure occurs, unplug the device and clean the product immediately in accordance with these guidelines.

Approved Cleanser Active Ingredients

100% of the active ingredients in any cleaner must consist of one or some combination of the following: isopropyl alcohol, or mild dish soap.

Harmful Ingredients

The following chemicals are known to damage the plastics on the device and should not come in contact with the device: ammonia solutions, compounds of amines or ammonia; acetone; ketones; ethers; aromatic and chlorinated hydrocarbons; aqueous or alcoholic alkaline solutions; ethanolamine; toluene; trichloroethylene; benzene; carbolic acid and TB-lysoform.

Cleaning Instructions

Do not apply liquid directly to the device. Dampen a soft cloth or use pre-moistened wipes. Do not wrap the device in the cloth or wipe, but gently wipe the unit. Be careful not to let liquid pool around the display window or other places. Allow the unit to air dry before use.

Special Cleaning Notes

Many vinyl gloves contain phthalate additives, which are often not recommended for medical use and are known to be harmful to the housing of the device. The device should not be handled while wearing vinyl gloves containing phthalates, or before hands are washed to remove contaminant residue after gloves are removed. If products containing any of the harmful ingredients listed above are used prior to handling the device, such as hand sanitizer that contain ethanolamine, hands must be completely dry before handling the device to prevent damage to the plastics.

Cleaning Materials Required

- Alcohol wipes
- Lens tissue
- Cotton-tipped applicators
- Isopropyl alcohol

- Can of compressed air with a tube.

Cleaning Frequency

The cleaning frequency is up to the customer's discretion due to the varied environments in which the mobile devices are used. They may be cleaned as frequently as required, but it is advisable to clean the camera window periodically when used in dirty environments to ensure optimum performance.

Cleaning the TC55

Housing

Using the alcohol wipes, wipe the housing including buttons.

Display

The display can be wiped down with the alcohol wipes, but care should be taken not to allow any pooling of liquid around the edges of the display. Immediately dry the display with a soft, non-abrasive cloth to prevent streaking.

Camera and Exit Window

Wipe the camera and exit window periodically with a lens tissue or other material suitable for cleaning optical material such as eyeglasses.

Connector Cleaning

To clean the connectors:

Procedure:

- 1 Remove the main battery from mobile computer.
- 2 Dip the cotton portion of the cotton-tipped applicator in isopropyl alcohol.
- 3 Rub the cotton portion of the cotton-tipped applicator back-and-forth across the connector. Do not leave any cotton residue on the connector.
- 4 Repeat at least three times.
- 5 Use the cotton-tipped applicator dipped in alcohol to remove any grease and dirt near the connector area.
- 6 Use a dry cotton-tipped applicator and repeat steps 4 through 6.



Caution: Do not point nozzle at yourself and others, ensure the nozzle or tube is away from your face.

- 7 Spray compressed air on the connector area by pointing the tube/nozzle about ½ inch away from the surface.
- 8 Inspect the area for any grease or dirt, repeat if required.

Cleaning Cradle Connectors

To clean the connectors on a cradle:

Procedure:

- 1 Remove the DC power cable from the cradle.
- 2 Dip the cotton portion of the cotton-tipped applicator in isopropyl alcohol.
- 3 Rub the cotton portion of the cotton-tipped applicator along the pins of the connector. Slowly move the applicator back-and-forth from one side of the connector to the other. Do not leave any cotton residue on the connector.
- 4 All sides of the connector should also be rubbed with the cotton-tipped applicator.



Caution: Do not point nozzle at yourself and others, ensure the nozzle or tube is pointed away from your face.

- 5 Spray compressed air in the connector area by pointing the tube/nozzle about ½ inch away from the surface.
- 6 Remove any lint left by the cotton-tipped applicator.
- 7 If grease and other dirt can be found on other areas of the cradle, use a lint-free cloth and alcohol to remove.
- 8 Allow at least 10 to 30 minutes (depending on ambient temperature and humidity) for the alcohol to air dry before applying power to cradle.

If the temperature is low and humidity is high, longer drying time is required. Warm temperature and dry humidity requires less drying time.

Troubleshooting

The following tables provides typical problems that might arise and the solution for correcting the problem.

Troubleshooting the TC55



Table 12: Troubleshooting the TC55

Problem	Cause	Solution
When the user presses the Power button, the TC55 does not turn on.	Battery is completely discharged.	Re-charge or replace the battery.
	Battery not installed properly.	Install the battery properly. See Installing the Battery.
	Power button not held down long enough.	Press the Power button until the LED lights green.
	TC55 not responding.	Perform a hard reset. See Resetting the TC55.
When the user presses the Power button the TC55 does not turn on but a charge battery icon appears on the screen.	Battery charge level is very low.	Re-charge or replace the battery.
After connecting the TC55 to the Rugged Charge Cable, a battery charging icon appears on the screen.	Battery is depleted but is charging.	Press and hold the Power button to turn on the TC55.
When charging, the LED slowly blinks red.	The TC55 is at an extremely low power state.	Charge the TC55 for a few minutes. The LED will change to flashing green then press the Power button to turn on the TC55. If LED continuously blinks red, check power connections. Disconnect and reconnect connections.
Battery did not charge.	Battery failed.	Replace battery. If the TC55 still does not operate, perform a hardware reset.
	TC55 was removed from power.	Insert TC55 in cradle or attach Charge Cable. The 2,940 mAh battery fully charges in approximately three hours and the 4,410 mAh battery charges in approximately 4.5 hours.

Table continued...

Problem	Cause	Solution
	er while battery was charging.	
	Extreme battery temperature.	Battery does not charge if ambient temperature is below 0 °C (32 °F) or above 40 °C (104 °F).
During data communication with a host computer, no data transmitted, or transmitted data was incomplete.	TC55 removed from USB cable or disconnected from host computer during communication.	Reattach the communication cable and re-transmit.
	Incorrect cable configuration.	See the system administrator.
During data communication over Wi-Fi, no data transmitted, or transmitted data was incomplete.	Wi-Fi radio is not on.	Turn on the Wi-Fi radio.
	You moved out of range of an access point.	Move closed to an access point.
During data communication over Bluetooth, no data transmitted, or transmitted data was incomplete.	Bluetooth radio is not on.	Turn on the Bluetooth radio.
	You moved out of range of another Bluetooth device.	Move without 10 m (32.8 ft.) of the other device.
During data communication over WAN, no data transmitted, or transmitted data was incomplete.	You are in an area of poor cellular service.	Move into an area that has better service.
	APN is not set up correctly.	See system administrator for APN setup information.
	SIM card not installed properly.	Remove and re-install the SIM card. See Installing the SIM Card on page 22 .
	Data plan not activated.	Contact your service provider and ensure that your data plan is enable.
No sound.	Volume setting is low or turned off.	Adjust the volume.
TC55 turns off.	TC55 is inactive.	The display turns off after a period of inactivity. Set this period to 15 seconds, 30 seconds, 1, 2, 5, 10, or 30 minutes.
	Battery is depleted.	Recharge or replace the battery.
	Extreme battery temperature.	Move device to an area where the ambient temperature is between -10 °C (+14 °F) and +60 °C (+140 °F).

Table continued...

Problem	Cause	Solution
A message appears stating not enough storage memory.	Too many applications installed on the TC55.	Remove user-installed applications on the TC55 to recover memory. Select  or  >  Apps > Downloaded . Select the unused programs and touch Uninstall .
The TC55 does not decode when reading bar code.	DataWedge is not enable.	Ensure that DataWedge is enabled and configured properly. Refer to the <i>TC55 Integrator Guide</i> for more information.
	Unreadable bar code.	Ensure the symbol is not defaced.
	Distance between the TC55 and bar code is incorrect.	Place the TC55 within proper scanning range.
	TC55 is not programmed for the bar code type.	Program the TC55 to accept the type of bar code being scanned. Refer to the <i>TC55 Integrator Guide</i> for DataWedge configuration.
	TC55 is not programmed to generate a beep.	If the TC55 does not beep on a good decode, set the application to generate a beep on good decode.
TC55 cannot find any Bluetooth devices nearby.	Too far from other Bluetooth devices.	Move closer to the other Bluetooth device(s), within a range of 10 meters (32.8 feet).
	The Bluetooth device(s) nearby are not turned on.	Turn on the Bluetooth device(s) to find.
	The Bluetooth device(s) are not in discoverable mode.	Set the Bluetooth device(s) to discoverable mode. If needed, refer to the device's user documentation for help.

Chapter

9

Technical Specifications

The following sections provide technical specification for the device.

TC55 Technical Specifications

The following table summarize the TC55's intended operating environment and technical hardware specifications.

Table 13: TC55 Technical Specifications

Item	Description
Physical Characteristics	
Dimensions	Height: 137 mm (5.4 in.) Width: 69 mm (2.7 in.) Depth (with 2,940 mAh battery): 15.9 mm (0.63 in.) Depth (with 4,410 mAh battery): 22.5 mm (0.89 in.)
Weight	TC55 with linear imager 2,940 mAh battery: 225 g (7.9 oz) TC55 with linear imager 4,410 mAh battery: 255 g (9.0 oz) TC55 with 2D imager 2,940 mAh battery: 230 g (8.1 oz) TC55 with 2D imager 4,410 mAh battery: 260 g (9.2 oz)
Display	4.3 in. color WVGA; 800 x 480, 700 NITs
Touch Panel	Gorilla Glass® 2
Backlight	LED backlight
Battery Pack	Rechargeable Lithium Ion 3.7V, 2,940 or 4,410 mAh Smart battery
Expansion Slot	User accessible microSD slot, up to 32 GB.
Connectivity	USB 2.0 (Host/Client)
Notification	LED, audio and vibration.
Keypad Options	On-screen keyboard and 4 capacitive front panel keys.
Audio	Speakers, dual noise cancelling microphones and headset connector (3.5 mm jack with microphone). Three speakers, including two front facing speakers; dual noise-cancelling microphones; high-quality speaker phone; 3.5 mm headset jack and Bluetooth wireless headset support.

Table continued...

Item	Description
Performance Characteristics	
CPU	1.5 GHz Dual Core Processor
Operating System	Professional Configuration – Android-based, Android Open-Source Project (AOSP) 4.1.2 or 4.4.3 Standard Configuration – Android-based, Android Open-Source Project (AOSP) 4.1.2 with Google Mobile Services or AOSP 4.4.3 with Google Mobile Services.
Memory	1 GB RAM, 8 GB Flash
Output Power (USB)	300 mA
User Environment	
Operating Temperature	-10 °C to 50 °C (14 °F to 122 °F)
Storage Temperature	-40 °C to 70 °C (-40 °F to 158 °F)
Charging Temperature	0° C to 40° C (32 °F to 104 °F)
Humidity	5% to 85% RH non-condensing
Drop Specification	Multiple 1.2 m (4 ft.) drops per MIL-STD 810G specifications. With protective boot: Multiple 1.2 m (4 ft.) drops to concrete across the operating temperature range.
Tumble Specification	150 0.5 m (1.5 ft.) tumbles (300 drops); With protective boot: 300 0.5 m (1.5 ft.) tumbles (600 drops); per applicable IEC tumble specifications.
Sealing	IP67 per applicable IEC sealing specifications.
Wireless WAN Data and Voice Communications	
Wireless Wide Area Network (WWAN) radio	4G LTE, HSPA+, DC-HSPA, EDGE/GPRS/GSM
Frequency band	TC55AH: GSM/EDGE: 850/900/1800/1900 MHz WCDMA: FDD2, FDD4, FDD5, FDD17 LTE Americas: LTE Band 2, LTE Band 5, LTE Band 17 TC55BH: GSM/EDGE: 850/900/1800/1900 MHz WCDMA: FDD1, FDD2, FDD5, FDD8 TC55CH: CDMA/EVDO: 850/1900 MHz (BC0/BC1) LTE: Band 13
GPS	Integrated, Autonomous, Assisted-GPS (A-GPS), GLONASS
Wireless LAN Data Communications	

Table continued...

Item	Description
Wireless Local Area Network (WLAN) radio	IEEE® 802.11a/b/g/n with internal antenna (ASOP 4.1.2) IEEE® 802.11a/b/g/n/d/h/i/k/d/r with internal antenna (ASOP 4.4.3)
Data Rates Supported	802.11b: 1, 2, 5.5, 11 Mbps 802.11a/g: 6, 9, 12, 18, 24, 36, 48, 54 Mbps 802.11n: 6.5, 13, 19.5, 26, 39, 52, 58.5, 65 Mbps Note that 802.11n data rates may be higher.
Operating Channels	Channel 36-165 (5180 – 5825 MHz), Channel 1-13 (2412-2472 MHz); actual operating channels/frequencies depend on regulatory rules and certification agency
Security	Security Modes: Legacy, WPA and WPA2 Encryption: WEP (40 and 128 bit), TKIP and AES Authentication: TLS, TTLS (MS-CHAP), TTLS (MS-CHAP v2), TTLS (PAP), PEAP (MS-CHAP v2), PEAP (GTC).
Spreading Technique	Direct Sequence Spread Spectrum (DSSS) and Orthogonal Frequency Division Multiplexing (OFDM)
Wireless PAN Data and Voice Communications	
Bluetooth	Class II, v 4.0; integrated antenna.(ASOP 4.1.2) Class II, v 4.0 Low Energy, integrated antenna.(ASOP 4.4.3)
Data Capture	
Linear Imager (SE-655)	Captures 1D bar codes.
2D imager (SE-4710)	Captures 1D and 2D bar codes.
Camera	For bar code scanning and image capture: 8 MP auto-focus camera; captures 1D and 2D bar codes, photographs, video, signatures and documents.
CS3070 Bluetooth Scanner (optional)	Captures 1D bar codes.
RS507 Hands-free Imager (optional)	Captures 1D and 2D bar codes.
Sensors	
Motion Sensor	3-axis accelerometer that enables motion sensing applications for dynamic screen orientation and power management.
Ambient Light Sensor	Automatically adjusts required display backlight to maximize power efficiency.
Proximity Sensor	Automatically detects when the user places the handset against head during a phone call to disable display output and touch input.
Electronic Compass	Independent — does not depend on GPS.
Imager (SE655) Specifications	
Scan Repetition Rate	Nominally 50 scans/second
Scan Angle	53.3° ± 3°

Table continued...

Item	Description
Roll	± 25°
Pitch Angle	± 65° from normal
Skew Tolerance	± 50° from normal
Ambient Light	Fluorescent: 450 ft. candles (4845 lux) High Efficiency Fluorescent: 450 ft. candles (4845 lux) Incandescent: 450 ft. candles (4845 lux) Mercury Vapor: 450 ft. candles (4845 lux) Sodium Vapor: 450 ft. candles (4845 lux) Sunlight: 900 ft. candles (9690 lux)
Supported Symbologies	
1D	Chinese 2 of 5, Codabar, Code 11, Code 128, Code 39, Code 93, Coupon Code, Discrete 2 of 5, EAN-8, EAN-13, GS1 DataBar, GS1 DataBar 14, GS1 DataBar Expanded, GS1 DataBar Expanded Stacked, GS1 DataBar Limited, Interleaved 2 of 5, ISBT 128, Korean 2 of 5, Matrix 2 of 5, MSI, TLC39, Trioptic 39, UCC/EAN 128, UPCA, UPCE, UPCE1, UPC/EAN Supplementals, Webcode
2D (Camera or 2D imager)	Australian Postal, Aztec, Canadian Postal, Composite AB, Composite C, Data Matrix, Dutch Postal, Japanese Postal, Linked Aztec, Maxi Code, Micro PDF-417, microQR, PDF-417, QR Code, US Planet, UK Postal, US Postnet, USPS 4-state (US4CB)

Index

A

adaptive frequency hopping [139](#)
 adjust volume [68](#)
 airplane mode [39](#)
 albums [97](#)
 android version [15](#)
 application shortcuts [53](#)
 approved cleanser [172](#)
 audio modes [67](#)

B

battery
 charging [29](#)
 installation [27](#)
 battery cover [21](#)
 battery usage [37](#)
 bluetooth [139](#)
 Bluetooth
 PIN [140](#)
 security [140](#)
 Bluetooth call [74](#)
 Bluetooth headset [67](#), [75](#)
 build number [15](#)

C

call barring [77](#)
 call forwarding [77](#)
 call waiting [78](#)
 caller ID [78](#)
 camera [13](#), [14](#)
 camera settings [87](#), [94](#)
 charge cable [153](#), [155](#)
 charging error [30](#)
 charging indications [30](#)
 charging temperature [30](#)
 cleaning [172](#)
 cleaning instructions [172](#)
 conference call [71](#)
 configuration [13](#), [14](#)
 cradle
 connector cleaning [173](#)

D

datawedge [123](#)
 diagnostics [106](#)
 digital camera [116](#)
 display
 cleaning [173](#)
 DTMF tones [77](#)

E

Elemex [106](#)

emergency calling [67](#)
 exit window [21](#)

F

file browser [79](#)
 finger usage [42](#)
 five slot charge only cradle [157](#)
 five-slot charge only cradle [153](#)
 five-slot charge only cradle base [153](#)
 fixed dialing numbers [76](#)
 flash [21](#)
 font size [41](#)

H

HAC [77](#)
 handset mode [67](#)
 harmful ingredients [172](#)
 headset mode [67](#)
 hearing aid compatibility [77](#)

I

installing the battery [27](#)
 internet calling [78](#)

K

keyboard [55](#)

L

LED notification [45](#)
 low battery notification [38](#)

M

main battery charging [29](#)
 memory [13](#), [14](#)
 micro USB cable [153](#), [154](#)

N

naming folders [53](#)

O

operating system [13](#), [14](#)

P

panoramic [85](#), [91](#)
 photos [84](#), [88](#)
 power on [31](#)

R

radios [13](#), [14](#)
recording videos [86](#), [92](#)
related documents [16](#)
resetting [64](#)
ringtone [76](#)
RS507 scanning [122](#)

S

scan angle [117](#)
scanning range [117](#)
screen font size [41](#)
screen lock sound [45](#)
screen rotation [41](#)
screen timeout [41](#)
screen touch notification [45](#)
serial number [14](#)
service information [16](#)
set date [40](#)
set time [40](#)
set time zone [40](#)
setting
 camera [87](#), [94](#)
 video [87](#), [95](#)
setup [22](#)
SIM card installation [23](#)
soft reset [64](#)
spare battery [153](#)
speaker mode [67](#)
status bar [49](#)
system notification [45](#)

T

taking a panoramic photo [85](#), [91](#)
taking photos [84](#)
touch key light [42](#)
touch mode [42](#)
troubleshooting [174](#)
TTY [77](#)
TTY/HAC [77](#)

U

using a Bluetooth headset [67](#)
using a wired headset [67](#)
using the dialer [68](#)

V

vehicle cradle [153](#)
video settings [87](#), [95](#)
videos [84](#), [86](#), [88](#), [92](#)
voicemail setup [76](#)

W

wired headset [67](#)