

# WT41N0 WEARABLE TERMINAL USER GUIDE

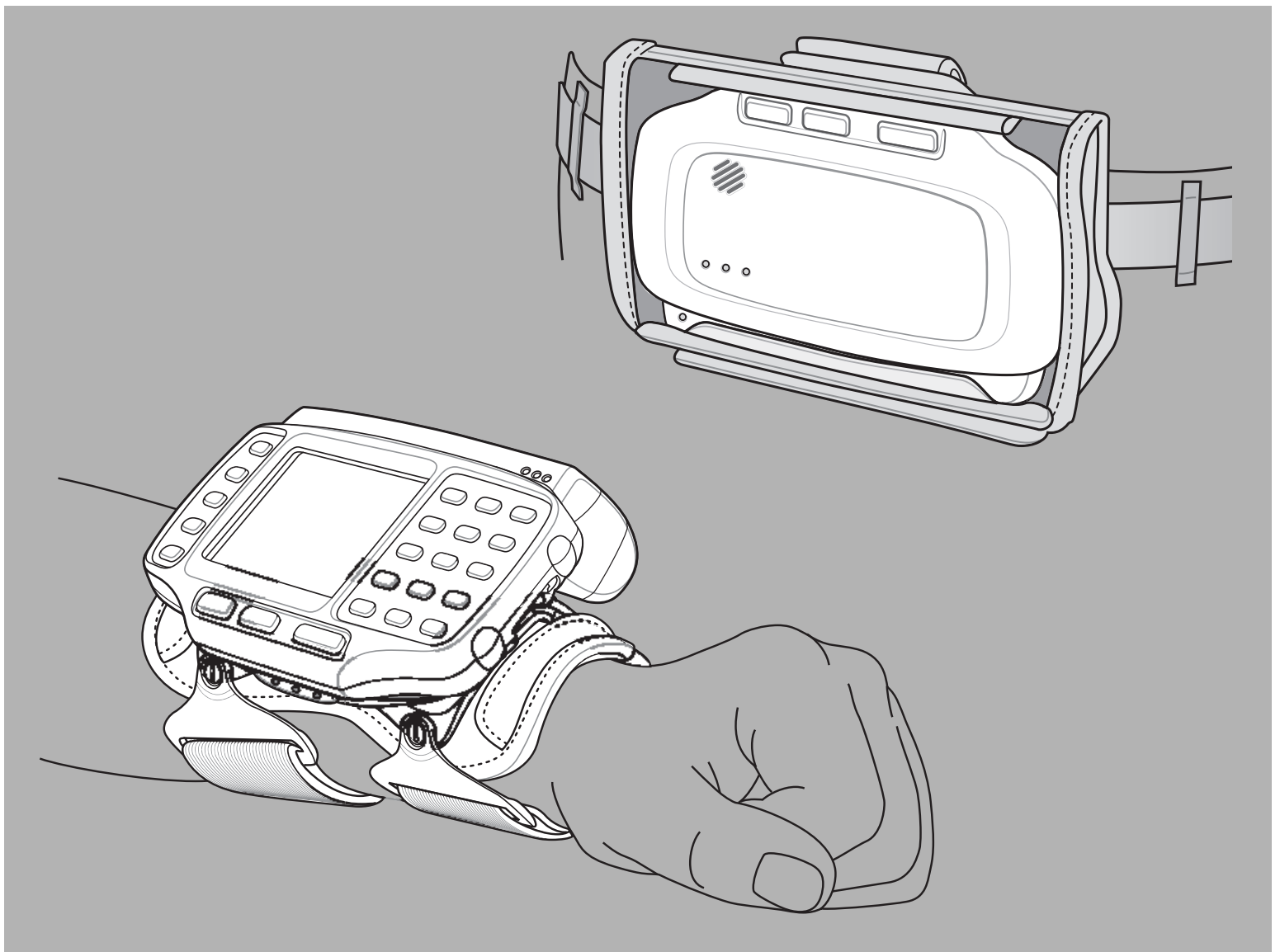



**WT41N0**  
**USER GUIDE**

72E-159561-04

Rev. A

December 2016

No part of this publication may be reproduced or used in any form, or by any electrical or mechanical means, without permission in writing from Zebra. This includes electronic or mechanical means, such as photocopying, recording, or information storage and retrieval systems. The material in this manual is subject to change without notice.

The software is provided strictly on an “as is” basis. All software, including firmware, furnished to the user is on a licensed basis. Zebra grants to the user a non-transferable and non-exclusive license to use each software or firmware program delivered hereunder (licensed program). Except as noted below, such license may not be assigned, sublicensed, or otherwise transferred by the user without prior written consent of Zebra. No right to copy a licensed program in whole or in part is granted, except as permitted under copyright law. The user shall not modify, merge, or incorporate any form or portion of a licensed program with other program material, create a derivative work from a licensed program, or use a licensed program in a network without written permission from Zebra. The user agrees to maintain Zebra’s copyright notice on the licensed programs delivered hereunder, and to include the same on any authorized copies it makes, in whole or in part. The user agrees not to decompile, disassemble, decode, or reverse engineer any licensed program delivered to the user or any portion thereof.

Zebra reserves the right to make changes to any software or product to improve reliability, function, or design.

Zebra does not assume any product liability arising out of, or in connection with, the application or use of any product, circuit, or application described herein.

No license is granted, either expressly or by implication, estoppel, or otherwise under any Zebra Technologies Corporation, intellectual property rights. An implied license only exists for equipment, circuits, and subsystems contained in Zebra products.

---

## Revision History

Changes to the original manual are listed below:

Change	Date	Description
-01 Rev A	11/15/12	Initial release.
-02 Rev A	12/1/14	Zebra rebranding
-02 Rev B	3/2015	Zebra rebranding
-03 Rev A	11/2016	Add RS5000 to supported devices.
-04 Rev A	12/2016	Update RS5000 Datawedge instructions.



# TABLE OF CONTENTS

Revision History .....	iii
------------------------	-----

## About This Guide

Introduction .....	ix
Documentation Set .....	ix
Configurations .....	x
Software Versions .....	x
Chapter Descriptions .....	xi
Notational Conventions .....	xi
Related Documents and Software .....	xii
Service Information .....	xii

## Chapter 1: Getting Started

Introduction .....	1-1
Unpacking the Wearable Terminal .....	1-3
Getting Started .....	1-7
Installing and Removing the Main Battery .....	1-7
Installing the Main Battery .....	1-7
Charging the Battery .....	1-8
Charging the Main Battery and Backup Battery .....	1-8
Charging Spare Batteries .....	1-9
Removing the Main Battery .....	1-9
Installing the Wrist Mount .....	1-10
Install a Hip Mount .....	1-12
Routing an Extended Cable Scanner .....	1-13
Connecting a Scanner .....	1-14
Starting the Wearable Terminal .....	1-14
WT41N0 Boot Up .....	1-14
Voice Only WT41N0 Boot Up .....	1-15

## Chapter 2: Using the Wearable Terminal

Introduction .....	2-1
--------------------	-----

Power Button .....	2-1
LED Indicators .....	2-2
Keypads .....	2-4
Alphanumeric Keypad .....	2-4
Voice Only Keypad .....	2-7
Display .....	2-8
App Launcher Window .....	2-8
Windows CE 7.0 Desktop .....	2-9
Status Icons .....	2-9
Programs Menu .....	2-10
Control Panel .....	2-12
Using the Keypad to Navigate Applications .....	2-13
Key Combinations .....	2-13
Selecting Items .....	2-14
Navigating Menus .....	2-14
Navigating Tabs .....	2-15
Navigating Fields .....	2-15
Selecting Checkboxes and Radio Buttons .....	2-15
Selecting Items in a List .....	2-15
Screen Calibration .....	2-16
Adjusting the Display Brightness .....	2-17
Special Character Keypad .....	2-17
Locking the WT41N0 .....	2-18
Un-locking with Simple PIN .....	2-18
Un-locking with Strong Password .....	2-19
Resetting the Wearable Terminal .....	2-19
Performing a Warm Boot .....	2-19
Performing a Cold Boot .....	2-20
Waking the Wearable Terminal .....	2-21
Battery Health .....	2-21
Interactive Sensor Technology .....	2-22
Free Fall Detection .....	2-22
Simultaneous Audio .....	2-22
Normal .....	2-22
Bluetooth headset and Speaker .....	2-22
Wired Headset and Speaker .....	2-23
Bluetooth Headset and Wired Headset .....	2-23

### Chapter 3: Data Capture

Introduction .....	3-1
Laser Scanning .....	3-1
Scanning Bar Codes .....	3-1
Scanning Tips .....	3-2
Adaptive Scanning .....	3-2
Imaging .....	3-3
Operational Modes .....	3-3
Imager Scanning .....	3-3
RS507 Scanning .....	3-3
RS5000 Scanning .....	3-4
Scanning Considerations .....	3-5



Setting Up the RS507 Hands-free Imager .....	3-5
Setting Up the RS5000 Imager .....	3-6
DataWedge .....	3-6
Enable DataWedge .....	3-6
Disable DataWedge .....	3-7
Using DataWedge to Read bar Codes .....	3-7

#### **Chapter 4: Wireless Applications**

Introduction .....	4-1
Signal Strength Icon .....	4-2
Turning Off the Radio .....	4-3
Minimum Setup .....	4-3

#### **Chapter 5: Accessories**

Introduction .....	5-1
Single Slot USB Cradle .....	5-3
Battery Charging Indicators .....	5-4
Four Slot Ethernet Cradle .....	5-5
Battery Charging .....	5-5
LED Indicators (CRD4000-4000ER) .....	5-6
LED Indicators (CRD4001-4000ER) .....	5-6
Four Slot Spare Battery Charger .....	5-7
Spare Battery Charging with the Four Slot Spare Battery Charger .....	5-7
Battery Charging Indicators .....	5-7
RS409/RS419 Scanner .....	5-8
RS309 Scanner .....	5-10
RS507 Imager .....	5-12
RS5000 Imager .....	5-12
Freezer Pouch .....	5-13
Wired Headset .....	5-16
Connector Shroud .....	5-18
Assembly .....	5-18
Disconnecting the Cable from the Wearable Terminal .....	5-18

#### **Chapter 6: Maintenance & Troubleshooting**

Introduction .....	6-1
Maintaining the Wearable Terminal .....	6-1
Wrist Mount Cleaning Instructions .....	6-2
Arm Sleeve Cleaning Instructions .....	6-2
Removing the Screen Protector .....	6-2
Battery Safety Guidelines .....	6-3
Cleaning .....	6-4
Materials Required .....	6-4
Cleaning the Wearable Terminal .....	6-4
Housing .....	6-4
Display .....	6-4
Connectors .....	6-4
Cleaning the RS309, RS409, RS419, RS507 and RS5000 .....	6-5

Housing .....	6-5
Scanner Exit Window .....	6-5
Connectors .....	6-5
Cleaning Cradle Connectors .....	6-6
Cleaning Frequency .....	6-6
Troubleshooting .....	6-7
Wearable Terminal .....	6-7
Four Slot Ethernet Cradle .....	6-10
Four Slot Spare Battery Charger .....	6-11
Single Slot USB Cradle .....	6-12

**Appendix A: Specifications**

Technical Specifications .....	A-1
Wearable Terminal .....	A-1

**Glossary**

**Index**

# ABOUT THIS GUIDE

---

## Introduction

This guide provides information about using the WT41N0 family of mobile terminals and accessories. The WT41N0 has two versions, one with a display and a voice only version without a display. Throughout this guide Voice Only WT41N0 refers to the version without the display and WT41N0 refers to the version with a display.

✓ **NOTE** Screens and windows pictured in this guide are samples and can differ from actual screens.

## Documentation Set

The documentation set for the WT41N0 is divided into guides that provide information for specific user needs.

- **WT41N0 Quick Start Guide** - provides basic setup and usage information for the WT41N0.
- **Voice Only WT41N0 Quick Start Guide** - provides basic setup and usage information for the Voice Only WT41N0.
- **WT41N0 User Guide** - describes how to use the WT41N0 wearable terminal.
- **WT41N0 Integrator Guide** - describes how to set up the WT41N0 wearable terminal and the accessories.
- **EMDK Help File** - provides API information for writing applications.

## Configurations

This guide covers the following configurations:

Configuration	Radios	Display	Memory	Data Capture	Operating System	Keypads
WT41N0	WLAN: 802.11a/b/g/n WPAN: Bluetooth	2.8" QVGA Color; non-touch	2 GB Flash/ 512 MB RAM	Optional accessory	Windows CE 7.0 Professional	Alphanumeric Keypad
		2.8" QVGA Color; touch	2 GB Flash/ 512 MB RAM	Optional accessory	Windows CE 7.0 Professional	Alphanumeric Keypad
Voice Only WT41N0	WLAN: 802.11a/b/g/n WPAN: Bluetooth	None	2 GB Flash/ 512 MB RAM	Optional accessory	Windows CE 7.0 Professional	Three programmable keys

## Software Versions



**NOTE** To view the software versions on the Voice Only WT41N0, the Voice Only WT41N0 must be connected to a host computer running remote desktop software. Refer to the *WT41N0 Integrator Guide* for more information.

This guide covers various software configurations and references are made to operating system or software versions for:

- OEM version
- Fusion version.

### OEM Software

To determine the OEM software version:

1. Press **CTRL** and then **ESC** to open the **Start** menu.
2. Using the navigation keys, select **Settings**.
3. Press the Blue key and the down arrow to open the **Control Panel** sub-menu.
4. Press **ENTER** key to launch **Control Panel**.
5. Using the navigation keys, select the **System Information** icon.
6. Press **ENTER** key to launch **System Info** applet.

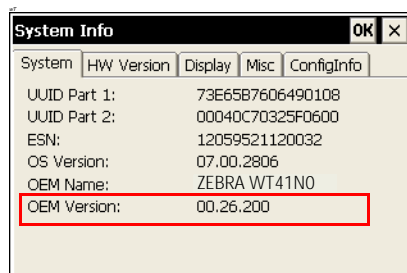

## Fusion Software

To determine the Fusion software version:

1. Press **ALT - w**. The **Wireless** menu appears.
2. Using the navigation keys, select **Wireless Status**.
3. Press **ENTER**. The Wireless Status window displays.
4. Press **7**. The **Versions** screen appears.

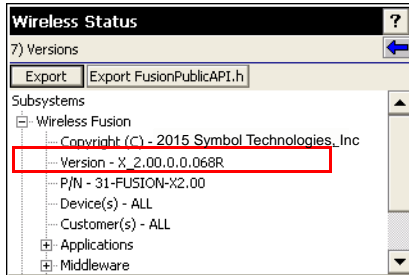

---

## Chapter Descriptions

Topics covered in this guide are as follows:

- [Chapter 1, Getting Started](#), provides information on getting the wearable terminal up and running for the first time.
- [Chapter 2, Using the Wearable Terminal](#), explains how to use the wearable terminal. This includes instructions for powering on and resetting the wearable terminal, entering and capturing data.
- [Chapter 3, Data Capture](#), describes the data capture options available for the WT41N0.
- [Chapter 4, Wireless Applications](#), provides information about the wireless applications.
- [Chapter 5, Accessories](#), describes the accessories available for the wearable terminal and how to use the accessories with the wearable terminal.
- [Chapter 6, Maintenance & Troubleshooting](#), includes instructions on cleaning and storing the wearable terminal, and provides troubleshooting solutions for potential problems during wearable terminal operation.
- [Appendix A, Specifications](#), includes a table listing the technical specifications for the wearable terminal.

---

## Notational Conventions

The following conventions are used in this document:

- “Wearable terminal” refers to the WT41N0 series of wearable terminals.
- *Italics* are used to highlight the following:
  - Chapters and sections in this guide
  - Related documents

- **Bold** text is used to highlight the following:
  - Dialog box, window and screen names
  - Drop-down list and list box names
  - Check box and radio button names
  - Icons on a screen
  - Key names on a keypad
  - Button names on a screen.
- Bullets (•) indicate:
  - Action items
  - Lists of alternatives
  - Lists of required steps that are not necessarily sequential.
- Sequential lists (e.g., those that describe step-by-step procedures) appear as numbered lists.

---

## Related Documents and Software

The following documents provide more information about the WT41N0 wearable terminals.

- *WT41N0 Quick Start Guide*, p/n 72-157178-xx
- *Voice Only WT41N0 Quick Start Guide*, p/n 72-162043-xx
- *WT41N0 Regulatory Guide*, p/n 72-159559-xx
- *WT41N0 Integrator Guide*, p/n 72E-160600-xx
- *RS309 Scanner Quick Reference Guide*, p/n 72-86011-xx
- *RS409 Scanner Quick Reference Guide*, p/n 72-86010-xx
- *RS419 Scanner Quick Reference Guide*, p/n 72-158357-xx
- *RS507 Hands-free Imager Quick Reference Guide*, p/n 72-115987-xx
- *RS507 Hands-free Imager Product Reference Guide*, p/n 72E-120802-xx
- *RS5000 Hands-free Imager Quick Start Guide*, p/n MN-002933-xx
- *Wireless Fusion Enterprise Mobility Suite User Guide for Version 2.XX*, p/n 72E-xxxxxx-xx
- *Enterprise Mobility Developer Kits*, available at: <http://www.zebra.com/support>.
- Device Configuration Package (DCP for WT41N0c70) and Platform SDK (PSDK41N0c70) for WT41N0 with Windows CE 7.0, available at: <http://www.zebra.com/support>.
- ActiveSync software, available at: <http://www.microsoft.com>.

For the latest version of this guide and all guides, go to: <http://www.zebra.com/support>.

---

## Service Information

If you have a problem with your equipment, contact Zebra Global Customer Support for your region. Contact information is available at: <http://www.zebra.com/support>.

When contacting Zebra Global Customer Support, please have the following information available:

- Serial number of the unit
- Model number or product name
- Software type and version number

Zebra responds to calls by email, telephone or fax within the time limits set forth in support agreements.

If your problem cannot be solved by Zebra Global Customer Support, you may need to return your equipment for servicing and will be given specific directions. Zebra is not responsible for any damages incurred during shipment if the approved shipping container is not used. Shipping the units improperly can possibly void the warranty.

If you purchased your Zebra business product from a Zebra business partner, contact that business partner for support.





# CHAPTER 1 GETTING STARTED

---

## Introduction

This chapter lists the parts and accessories for the wearable terminal and explains how to install and charge the batteries and start the wearable terminal for the first time.

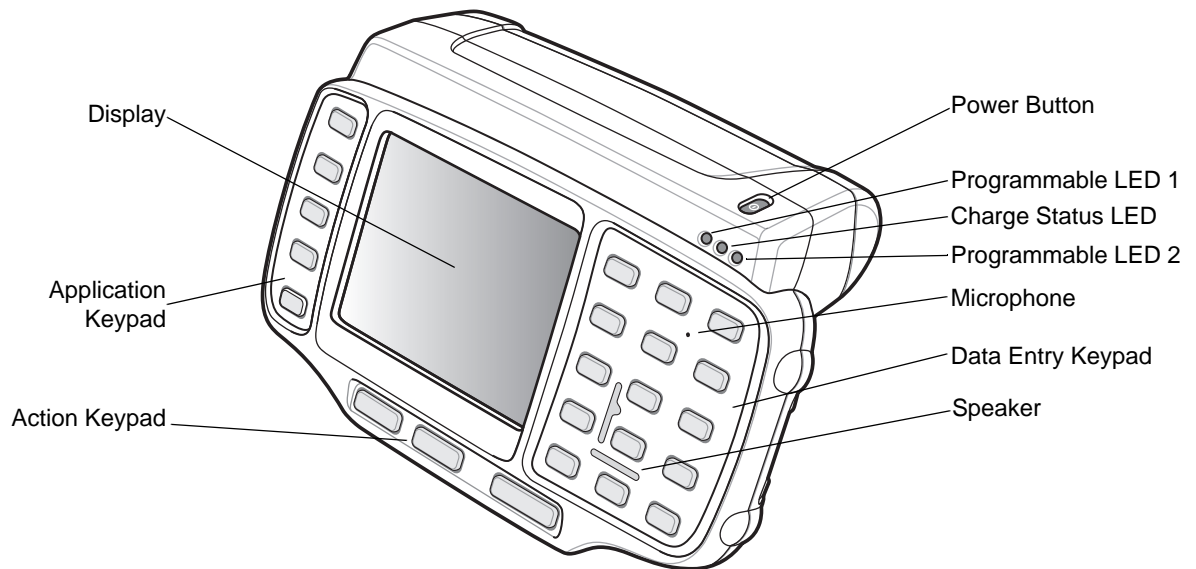

**Figure 1-1** WT41N0 Wearable Terminal Front View

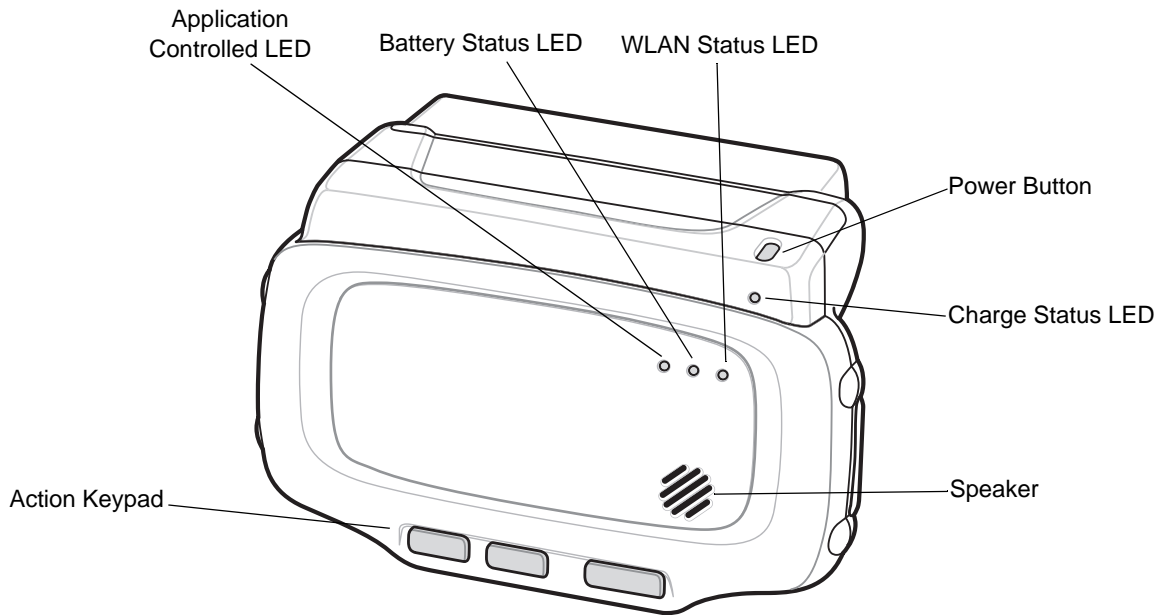

**Figure 1-2** Voice Only WT41N0 Wearable Terminal Front View

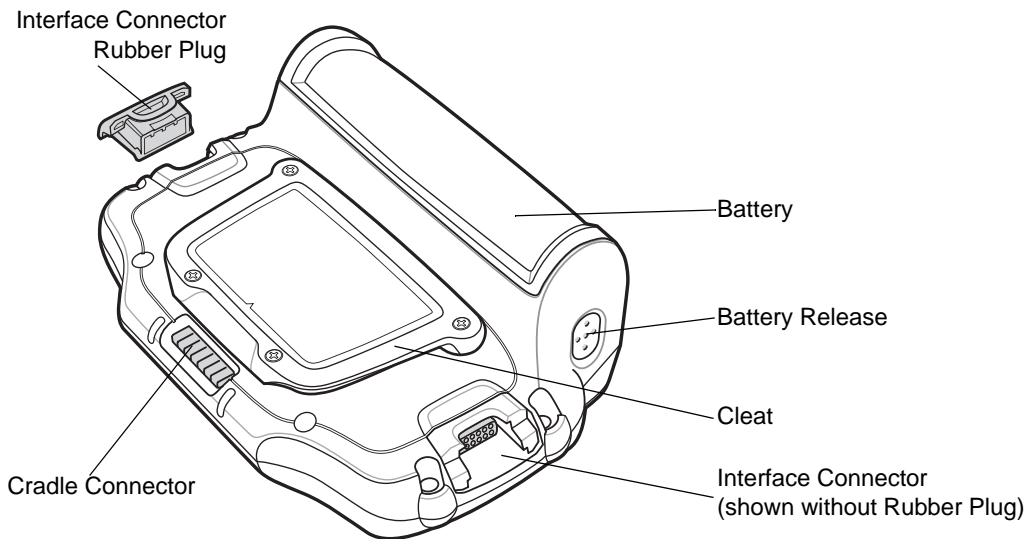

**Figure 1-3** Wearable Terminal Back View

**Table 1-1** Parts of the Wearable Terminal

Item	Description
Display	Displays the application and data stored on the device. (WT41N0 only)
Power Button	Places the wearable terminal in to the suspend mode or resumes normal operation. Performs a warm boot when held down for five seconds. See <a href="#">Resetting the Wearable Terminal on page 2-19</a> for information about performing a warm boot.
Charge Status LED	Indicates the charging status of the battery.
WLAN Status LED	Indicates the status of the wireless connection. (Voice Only WT41N0 only)

**Table 1-1** *Parts of the Wearable Terminal (Continued)*

Item	Description
Battery Status LED	Indicates when the battery charge level falls below 30%. (Voice Only WT41N0 only)
Application Controlled LED	Application programmable. (Voice Only WT41N0 only)
Programmable LEDs	Application programmable. (WT41N0 only)
Microphone	Provides audio input. (WT41N0 only)
Speaker	Provides audio playback.
Keypads	Enable user input.
Battery	Provides power to the wearable terminal.
Interface Connector	Provides electrical connection to an accessory, such as a scanner.
Cradle Connector	Provides electrical connection to a cradle.
Battery Release	Releases the battery for removal.
Cleat	Provides mounting for the wrist mount and cradles.

---

## Unpacking the Wearable Terminal

Carefully remove all protective material from around the wearable terminal and save the shipping container for later storage and shipping.

Verify that you received all equipment listed below:

- Wearable terminal
- Lithium-ion battery
- Regulatory Guide
- Quick Start Guide.

Inspect the equipment for damage. If you are missing any equipment or if you find any damaged equipment, contact the Zebra Global Customer Support Center immediately. See [page xii](#) for contact information.

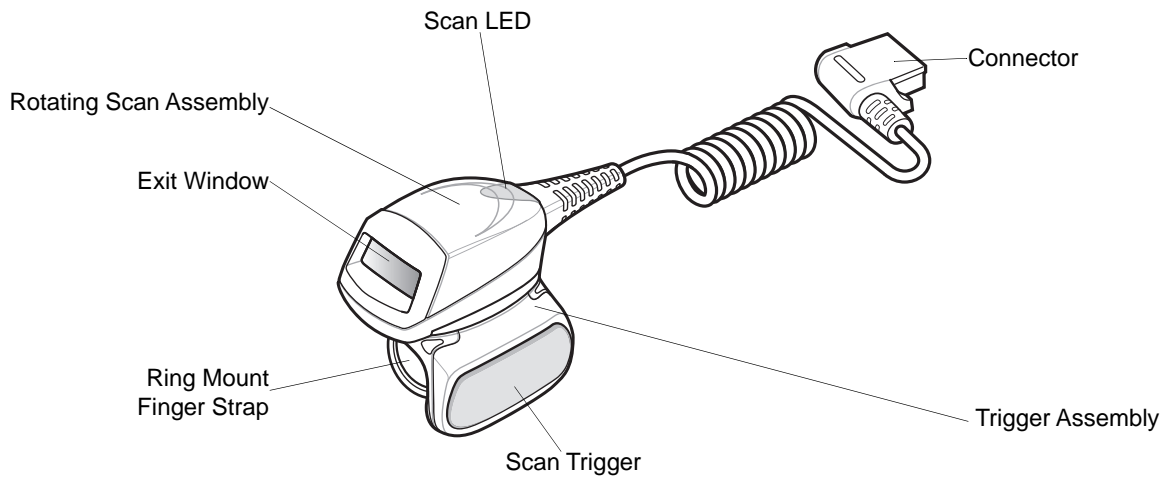

**Figure 1-4** *RS409 Scanner*

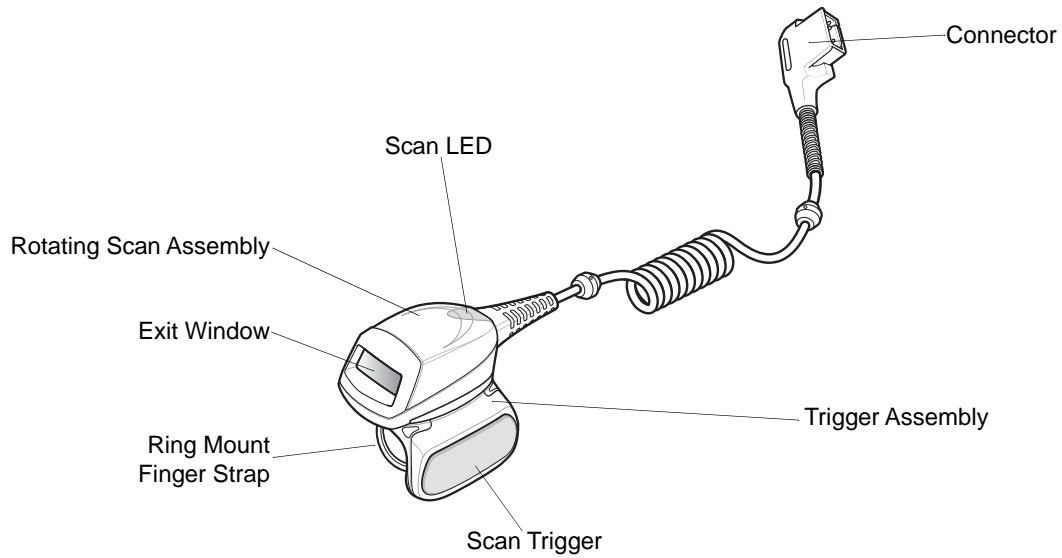

**Figure 1-5** *RS419 Scanner*

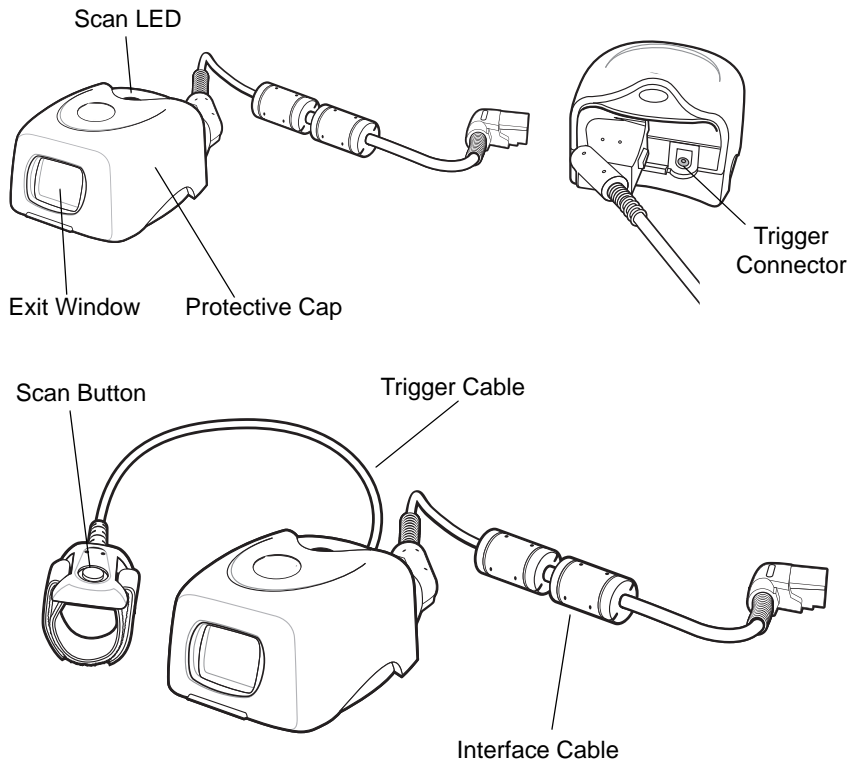

Figure 1-6 RS309 Scanner

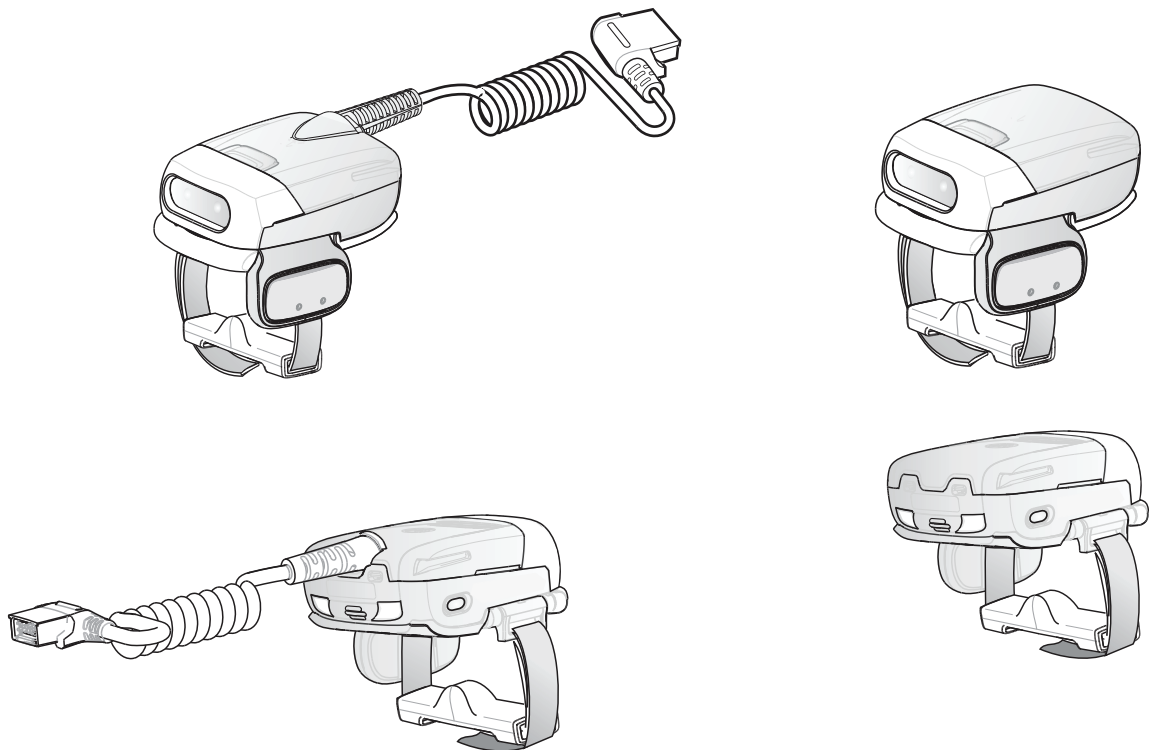
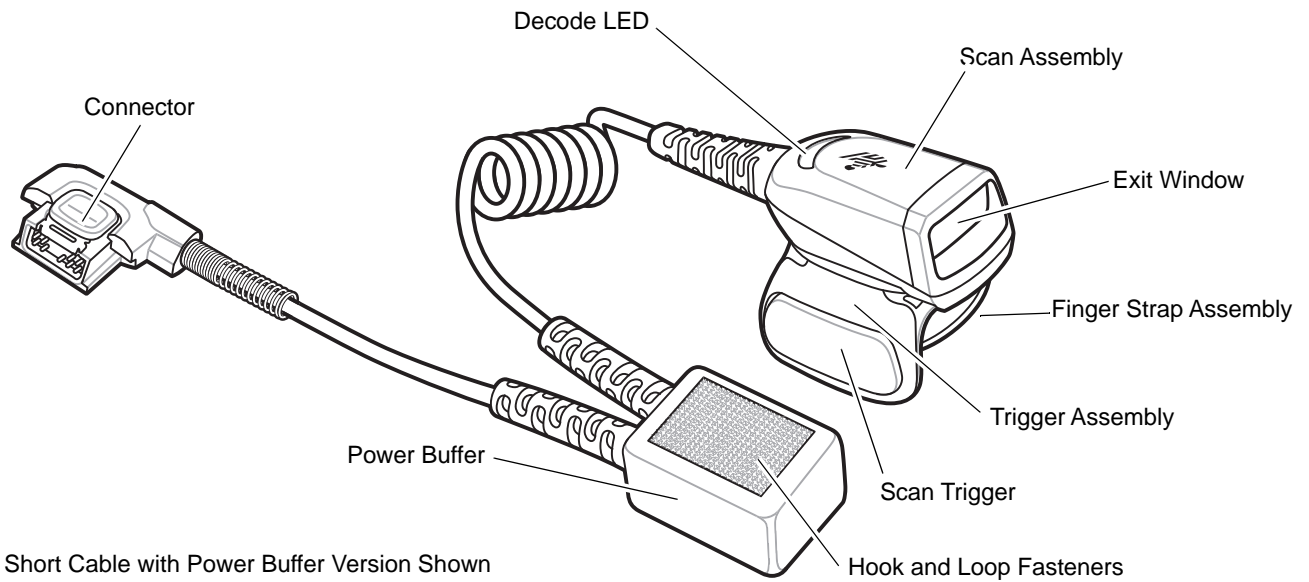

Figure 1-7 RS507 Hands-free Imager



**Figure 1-8** RS5000 Imager

---

## Getting Started

In order to start using the wearable terminal for the first time:

- Install the main battery
- Charge the main battery and backup battery
- Install the wearable terminal onto the wrist mount
- Install an optional scanner
- Start the wearable terminal.

✓ **NOTE** The main battery can be charged before or after installation into the wearable terminal. Use the Single Slot USB cradle or Four Slot Spare Battery Charger to charge the main battery before installation, or the Single Slot USB cradle or Four Slot Ethernet cradle to charge the main battery after installation.

---

## Installing and Removing the Main Battery

### Installing the Main Battery

Before using the wearable terminal, install a lithium-ion (Li-ion) battery by placing the battery into the wearable terminal as shown in [Figure 1-9](#).

✓ **NOTE** Ensure the battery is fully inserted. An audible click can be heard as the battery is fully inserted. A partially inserted battery may result in unintentional data loss.

When a battery is installed in a wearable terminal for the first time the wearable terminal boots and powers on automatically.

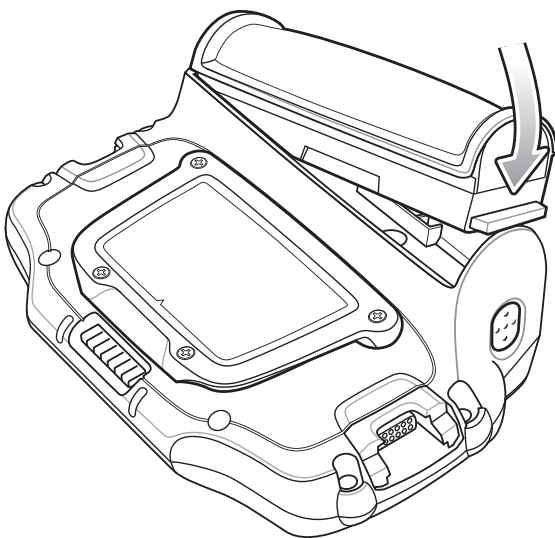

**Figure 1-9** Installing the Main Battery

## Charging the Battery



**CAUTION** Ensure that you follow the guidelines for battery safety described in [Battery Safety Guidelines on page 6-3](#).

### Charging the Main Battery and Backup Battery

Before using the wearable terminal for the first time, charge the main battery until the amber Charge Status LED remains lit (see [Table 1-2 on page 1-8](#) for charge status indications).

The wearable terminal is equipped with a backup battery which automatically charges from the main battery whether or not the wearable terminal is operating or is in suspend mode. The backup battery retains data in memory for at least 15 minutes when the wearable terminal's main battery is removed or fully discharged. When the wearable terminal is used for the first time or after the memory backup battery has fully discharged, the backup battery requires approximately 15 hours to fully charge. Do not remove the main battery from the wearable terminal for 16 hours to ensure that the memory backup battery fully charges. If the main battery is removed from the wearable terminal or the main battery is fully discharged, the backup battery completely discharges in several hours.

When the wearable terminal reaches a very low battery state, the combination of main battery and backup battery retains data in memory for at least 24 hours.



**NOTE** Do not remove the main battery within the first 15 hours of use. If the main battery is removed before the backup battery is fully charged, data may be lost.

Charge the wearable terminal with an installed main battery using either the Single Slot USB cradle or the Four Slot Ethernet cradle.

To charge the main battery:

1. Ensure the cradle used to charge the main battery is connected to the appropriate power source.
2. Insert the wearable terminal into a cradle.
3. The wearable terminal starts to charge automatically. The amber Charge Status LED lights to indicate the charge status. See [Table 1-2](#) for charging indications. The standard capacity battery fully charges in less than four hours and the extended battery fully charges in less than eight hours.

**Table 1-2** *Wearable Terminal LED Charge Indicators*

LED	Indication
Off	Wearable terminal is not in cradle. Wearable terminal not placed correctly. Charger is not powered.
Fast Blinking Amber	Charging error: <ul style="list-style-type: none"> <li>• Temperature is too low or too high.</li> <li>• Charging has gone on too long without completing (typically eight hours).</li> </ul>
Slow Blinking Amber	Wearable terminal is charging.
Solid Amber	Charging complete. Note: When the battery is initially inserted in the wearable terminal, the amber LED flashes once if the battery power is low or the battery is not fully inserted.



## Charging Spare Batteries

Use the following accessories to charge spare batteries:

- Single Slot USB Cradle
- Four Slot Spare Battery Charger.

To charge a spare battery:

1. Ensure the accessory used to charge the spare battery is connected to the appropriate power source.
2. Insert the spare battery into the accessory's spare battery charging slot with the charging contacts facing down (over the charging pins) and gently press down on the battery to ensure proper contact.
3. The battery starts to charge automatically. The amber charge LED on the accessory lights to show the charge status. See [Chapter 5, Accessories](#) for accessory charge LED indicator definitions.

The standard capacity battery fully charges in less than four hours and the extended capacity battery fully charges in less than eight hours.

## Removing the Main Battery

To remove the main battery:

1. Prior to removing the battery, ensure that the wearable terminal is in suspend mode. If the wearable terminal is not in suspend mode, press the Power button to place the wearable terminal in suspend mode.
2. Press the battery release button. The battery partially ejects from the wearable terminal.
3. Remove the battery from the wearable terminal.

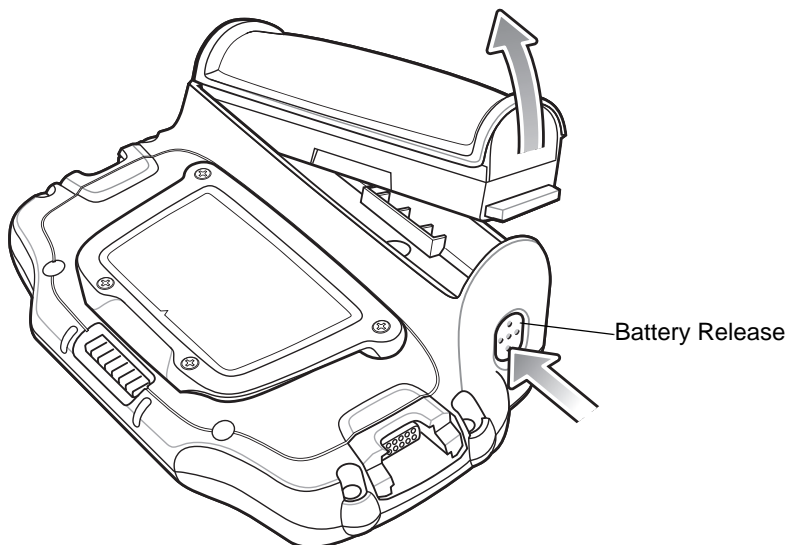

**Figure 1-10** *Removing the Main Battery*

## Installing the Wrist Mount

The wrist mount provides the mounting of the wearable terminal on the forearm for hands-free applications. Refer to the Wrist Mount Installation Guide for information on the wrist mount.

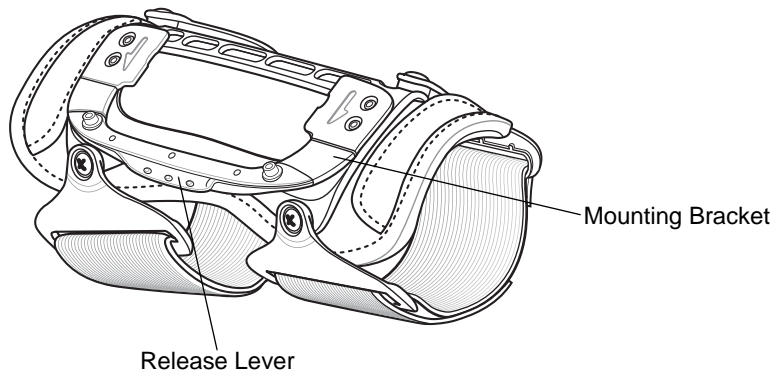

**Figure 1-11** *Wrist Mount*

To install the wrist mount:

1. Determine which arm the wrist mount will be used on.
2. Install the short strap on the end closest to the wrist.
3. Install the long strap on the other end.
4. Slide the hand into the wrist mount.
5. Tighten the straps.
6. Align the cleat on the back of the wearable terminal with the mounting bracket on the wrist mount.

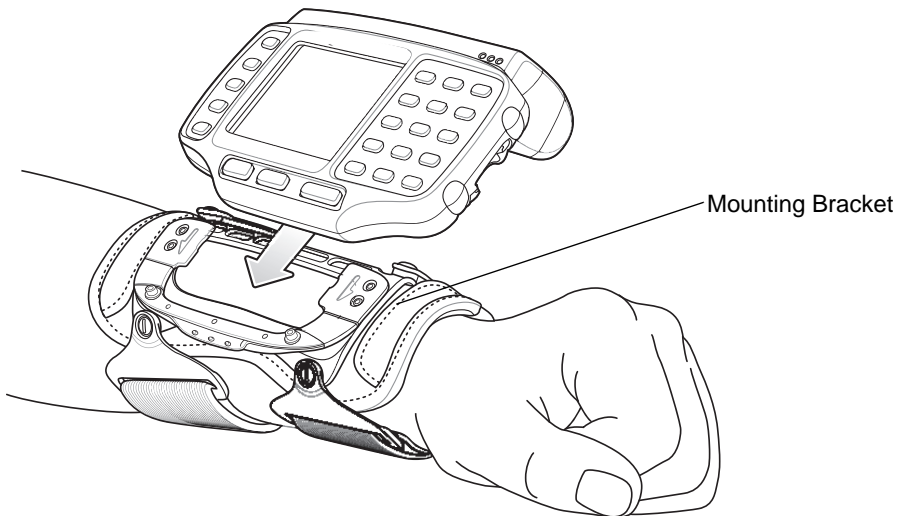

**Figure 1-12** *Aligning the Cleat*

7. Slide the wearable terminal onto the wrist mount until it clicks into place.
8. If necessary, loosen and re-tighten the straps.

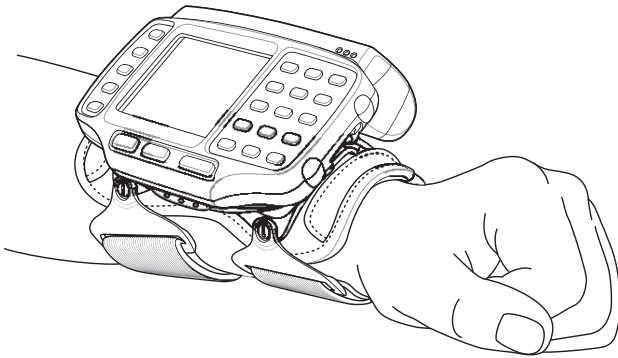

**Figure 1-13** *Wearable Terminal and Wrist Mount*

To remove the wearable terminal from the wrist mount, press down on the release lever and slide the wearable terminal out.

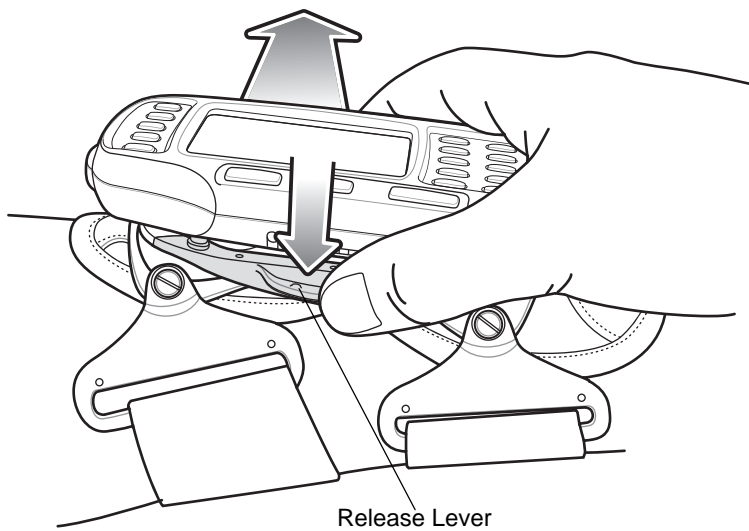
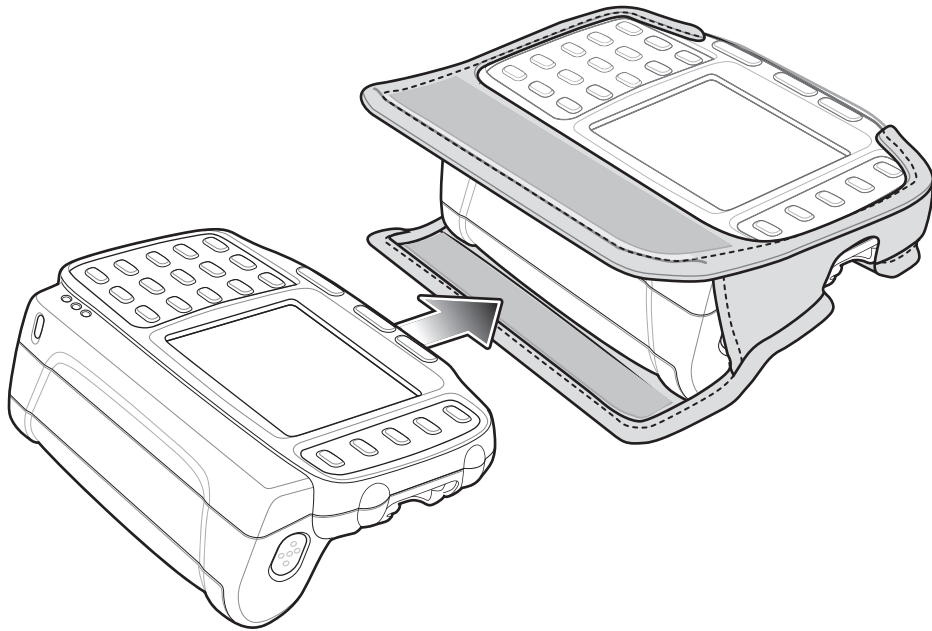

**Figure 1-14** *Wearable Terminal Removal*

## Install a Hip Mount

The hip mount allows the user to mount the wearable terminal on the hip for use in voice picking applications. An RS309, RS409 or RS419 scanner with an extended cable or the RS507 Hands-free Bluetooth Imager is required when using the hip mount.

Slide the wearable terminal into the hip mount.



**Figure 1-15** *Insert Wearable Terminal into Hip Mount*

Close the front flap followed by the back flap.

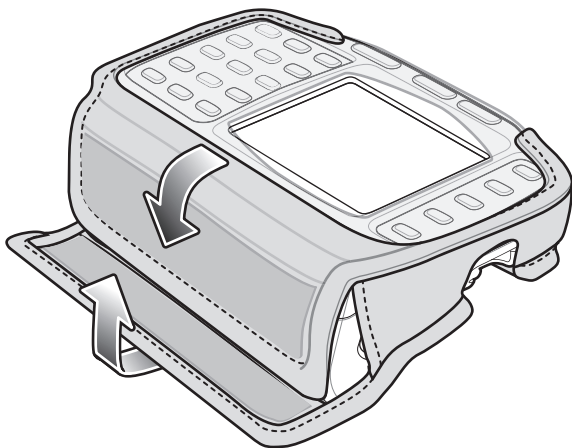

**Figure 1-16** *Close Hip Mount Flaps*

Slide a belt through the belt loop on the back of the hip mount. The wearable terminal can be mounted right-side up or up-side down depending upon user preference or application.

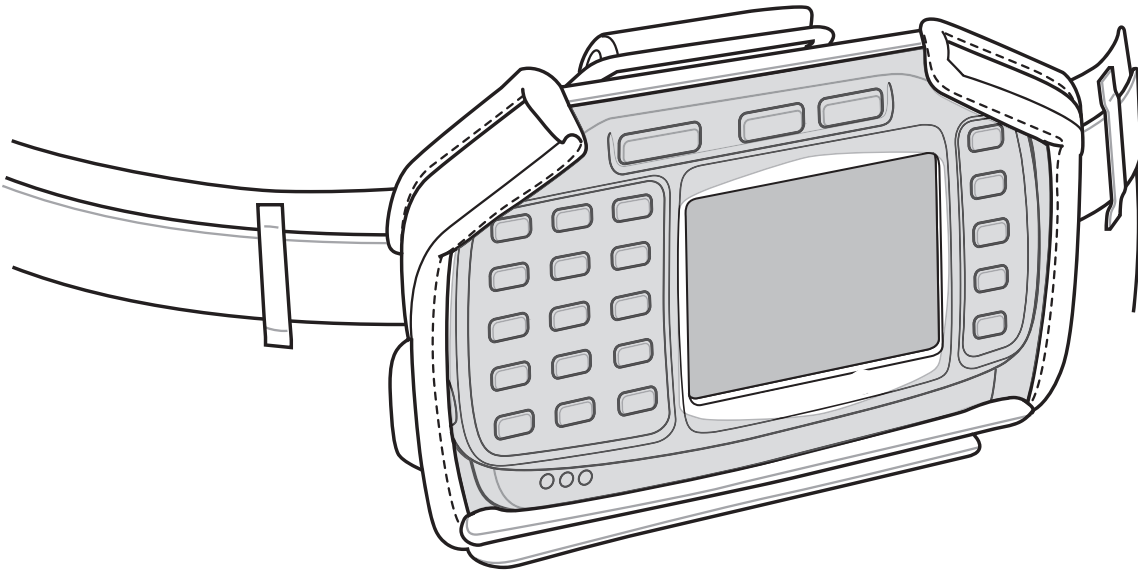

**Figure 1-17** *Hip Mount on Belt*

Connect accessories as required.

## Routing an Extended Cable Scanner

When using an RS309, RS409 or RS419 scanner with the wearable terminal mounted on the hip, the extended cable version is required.

Zebra offers for sale cable clips, which attach to clothing and hold the scanner cable so that the cable does not interfere with the user. The cable clips are similar to badge clips and can be purchased at any office supply store as well.

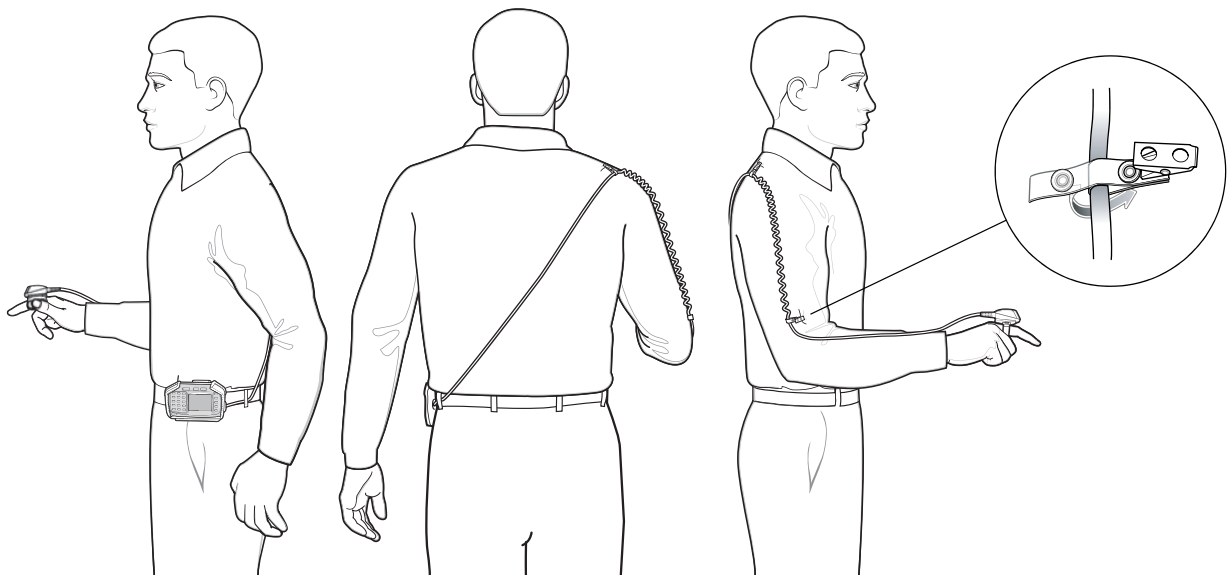

**Figure 1-18** *Routing RS409/419 Scanner Cable from Hip to Hand*

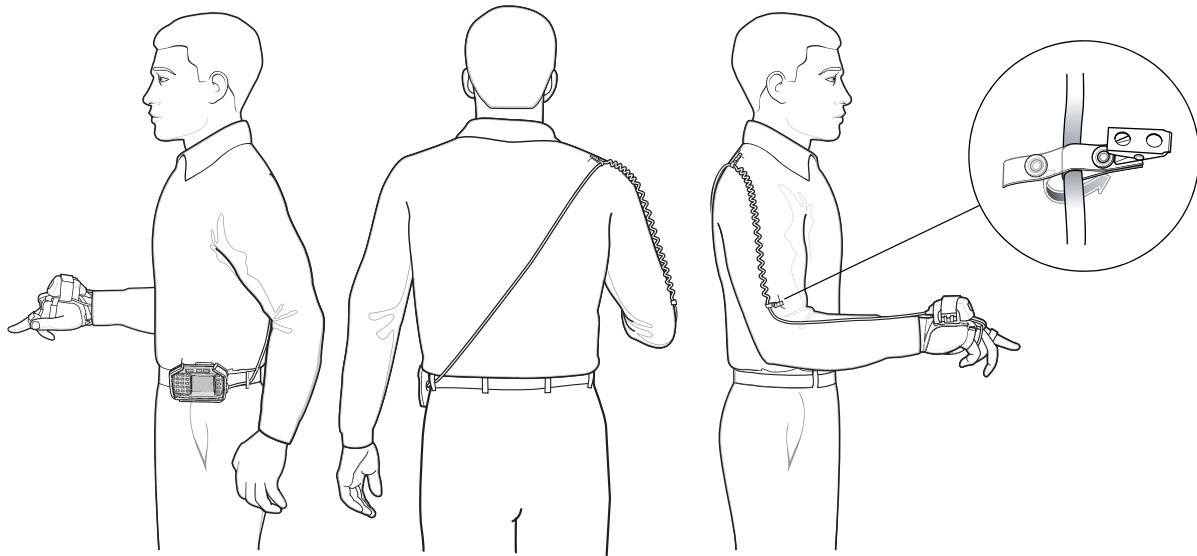

**Figure 1-19** Routing RS309 Scanner Cable from Hip to Hand

---

## Connecting a Scanner

The RS309, RS409, RS419 scanners and the RS507 and RS5000 imagers can be used with the wearable terminal. See [RS309 Scanner on page 5-10](#), [RS409/RS419 Scanner on page 5-8](#), or [RS5000 Imager on page 5-12](#) for procedures for connecting the scanner to the wearable terminal. Refer to the RS507 Product Reference Guide for procedures for connecting the imager to the wearable terminal.

---

## Starting the Wearable Terminal

Press the **Power** button to turn on the wearable terminal. If the wearable terminal does not power on, perform a cold boot. See [Resetting the Wearable Terminal on page 2-19](#).



**NOTE** When a battery is fully inserted in a wearable terminal for the first time, upon the wearable terminal's first power up, the device cold boots and powers on automatically.

## WT41N0 Boot Up

When the WT41N0 is powered on for the first time the splash screen ([Figure 1-20](#)) appears for a briefly followed by the Start Up window on non-touch configurations and the calibration screen on touch enabled configurations.



**Figure 1-20** *Splash Screen*

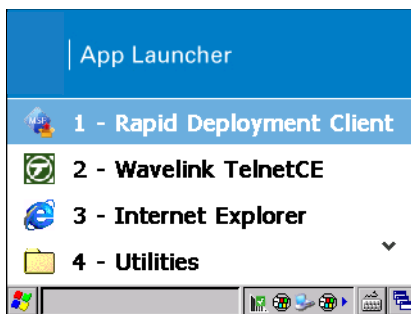

**Figure 1-21** *Start Up Window*

Use the **Calibration** screen to align the touch screen:

1. Carefully press and briefly hold on the center of the **Calibration** screen target. Repeat the procedure as the target moves and stops at different locations on the screen. This enters the new calibration settings.

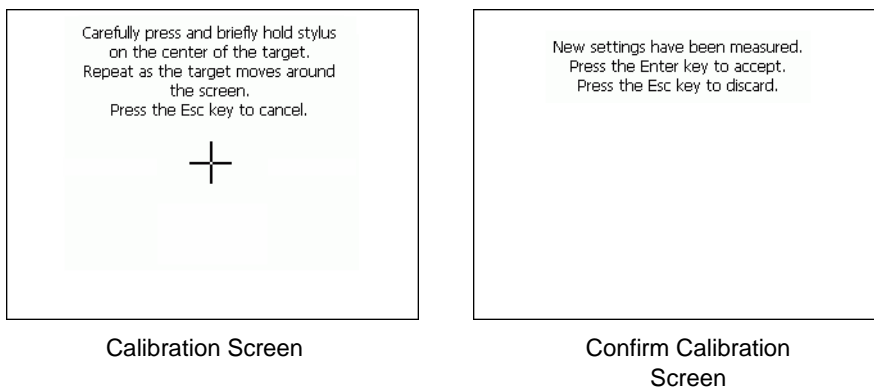
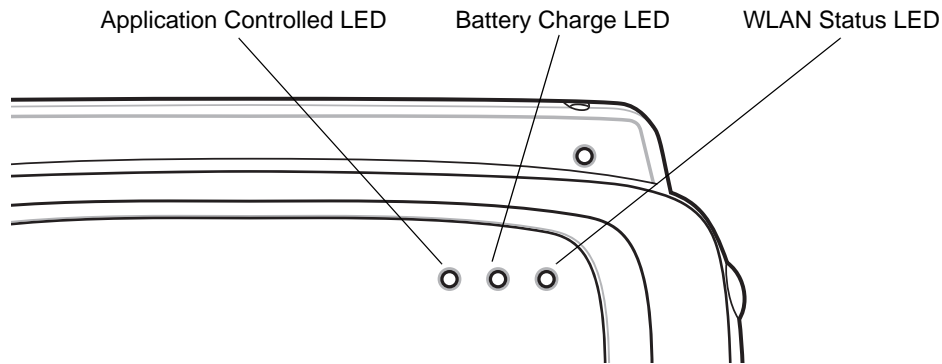

**Figure 1-22** *Calibration Screen*

2. Once all of the new calibration settings are input, tap the screen or press the **ENTER** button to save the new calibration settings. Press **ESC** to discard the new calibration settings.

## Voice Only WT41N0 Boot Up

When the Voice Only WT41N0 is powered on the three LEDs on the front housing light in the sequence shown in [Table 1-3](#).



**Figure 1-23** Voice Only WT41N0 LEDs

**Table 1-3** Voice Only WT41N0 Start Up LED Sequence

Sequence	Application Controlled LED	Battery Charge LED	WLAN Status LED
1	On	On	On
2	On	On	Off
3	Off	Off	Off
4	On	Off	Off
5	On	On	Off
6	On	On	On
7	On	On	Off
8	On	Off	Off
9	Off	Off	Off
10	Off	Off	On/Blinking

The WLAN Status LED blinks indicating that the wireless connection is not connected or is solid indicating that the wireless connection is connected.



# CHAPTER 2 USING THE WEARABLE TERMINAL

---

## Introduction

This chapter explains the physical buttons and controls on the wearable terminal, and provides basic instructions for using the wearable terminal, including powering on and resetting the wearable terminal, using a headset, entering information and scanning.

This chapter also details the operation of the Windows CE 7.0 operating system including the desktop, applications and settings. Depending upon the programs installed on the wearable terminal, some of these items may not be available.

---

## Power Button

Press the Power button to turn the wearable terminal screen on and off (suspend mode). The wearable terminal is on when the screen is on and the wearable terminal is in suspend mode when the screen is off. For more information, see [Starting the Wearable Terminal on page 1-14](#).

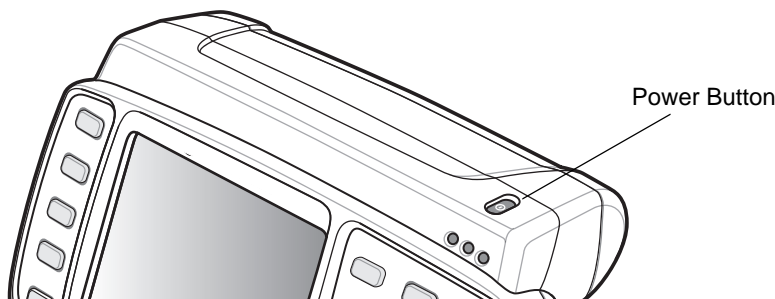

**Figure 2-1** Power Button

The Power button is also used to reset the wearable terminal by performing a warm or cold boot.

- Warm Boot (Soft Reset) - Resets the wearable terminal.
- Cold Boot (Hard Reset) - Resets the wearable terminal and restores all factory default settings.

## LED Indicators

The Charge Status LED indicates the wearable terminal charging status when the WT41N0 is in a cradle. [Table 2-1](#) describes the Charge Status LED indications.

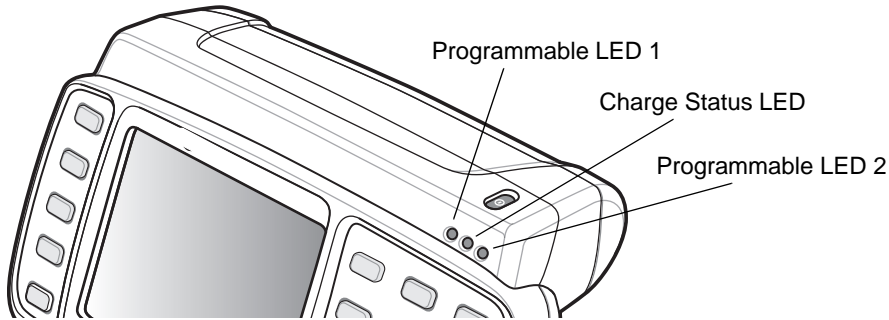

**Figure 2-2** Wearable Terminal LED Indicators

**Table 2-1** Charge Status LED Indications

LED	State	Indication
Charge Status LED (Amber)	Off	Wearable terminal is not in cradle. Wearable terminal not placed correctly. Charger is not powered.
	Slow Blinking Amber	Main battery in wearable terminal is charging.
	Fast Blinking Amber	Charging error: <ul style="list-style-type: none"> <li>• Temperature is too low or too high.</li> <li>• Charging has gone on too long without completing (typically eight hours).</li> </ul>
	Solid Amber	Charging complete. Note: When the battery is initially inserted in the wearable terminal, the amber LED flashes once if the battery power is low or the battery is not fully inserted.
Programmable LED 1 (Light Green)	-	Application dependent.
Programmable LED 2 (Green)	-	Application dependent.

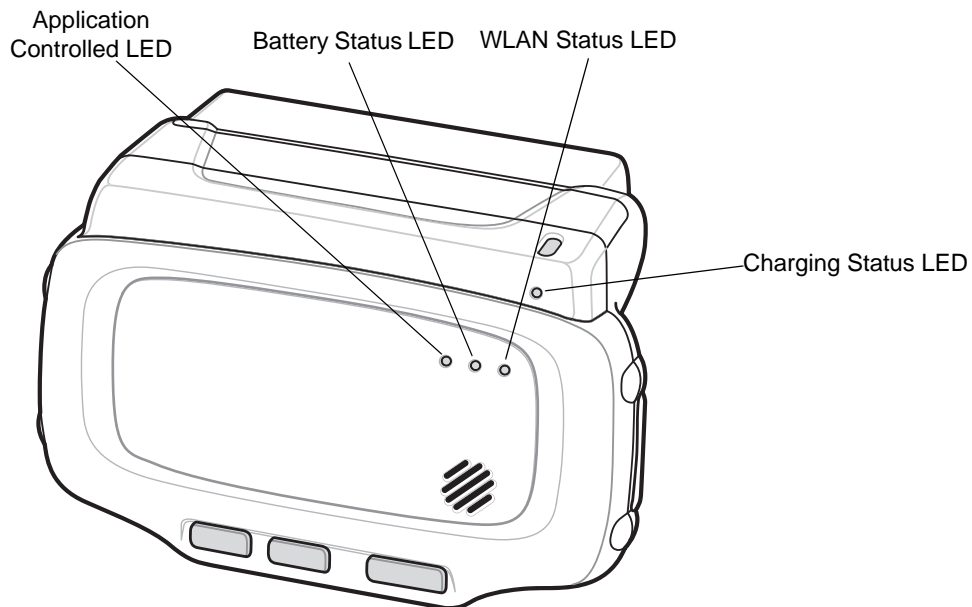

**Figure 2-3** Voice Only WT41N0 LED Indicators

The Voice Only WT41N0 has three status LEDs. [Table 2-2](#) lists the default LED indications. LED functionality can be changed by an application.

**Table 2-2** Voice Only WT41N0 LED Indications

LED	State	Indication
WLAN Status LED (Green)	Off	Battery completely discharged or device error. Contact system administrator.
	Blinking	Voice Only WT41N0 is not connected to a wireless network.
	Solid	Voice Only WT41N0 is connected to a wireless network.
Battery Status LED (Light Green)	Off	Battery charge level is greater than 30%
	Blinking	Battery charge level is less than 30%.
Application Controlled LED (Yellow)	-	Application dependent.

## Keypads

The wearable terminal has the following keypads:

- Alphanumeric keypad
- Voice Only keypad.

### Alphanumeric Keypad

The alphanumeric keypad contains application keys, scroll keys and function keys. The keypad is color-coded to indicate the alternate function keys (blue, orange and gray). Note that keypad functions can be changed by an application so the wearable terminal's keypad may not function exactly as described. See [Table 2-3 on page 2-4](#) for key and button descriptions and [Table 2-4 on page 2-5](#) for the keypad's special functions.

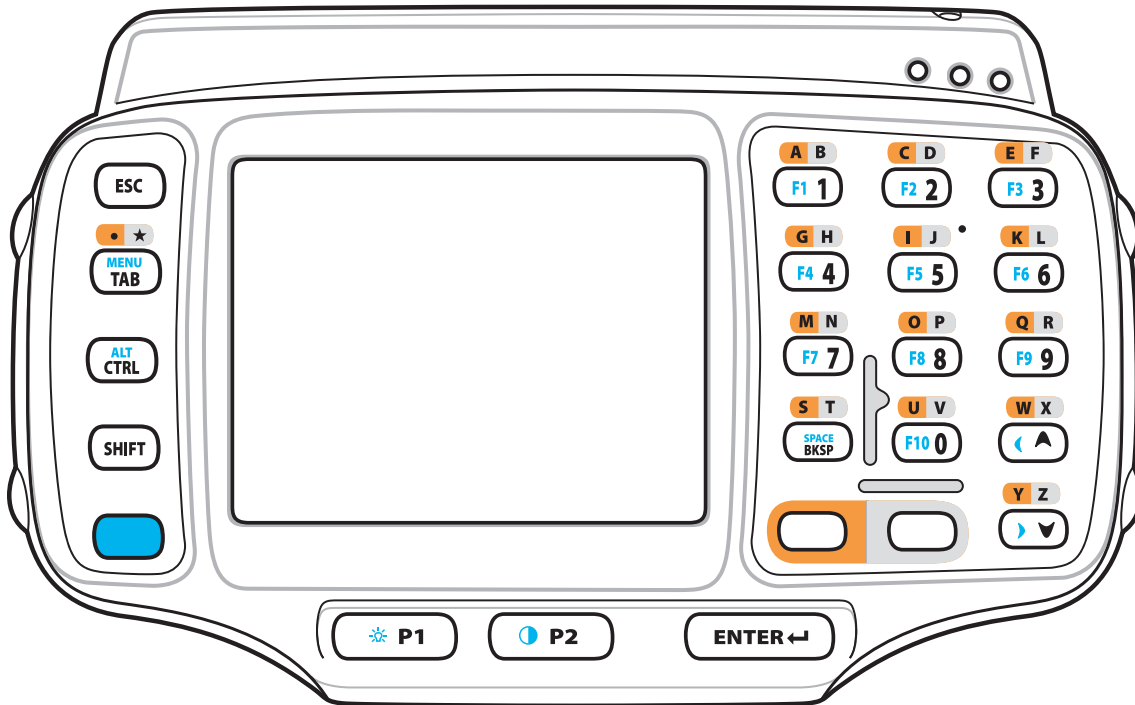







Figure 2-4 Alphanumeric Keypad

Table 2-3 Alphanumeric Keypad Descriptions

Key	Description
Orange	Press and release the Orange key to activate alphabetic characters (shown on the keypad in orange). The  icon appears in the Taskbar.
Gray	Press and release the Gray key to activate alphabetic characters (shown on the keypad in gray). The  icon appears in the Taskbar.
Blue	Press and release the Blue key to activate the keypad alternate functions (shown on the keypad in blue). The  icon appears in the Taskbar.

**Table 2-3** *Alphanumeric Keypad Descriptions (Continued)*

Key	Description
Scroll Keys	Moves up or down from one item to another or increases/decreases specified values. Moves left or right from one item to another when used with the Blue key. For each left or right scroll, the Blue key must be pressed first.
ESC	Exits the current operation.
Alphanumeric	In default state, produces the numeric value on the key. In Left Alpha state, produces the lower case alphabetic characters in the orange area. In Right Alpha state, produces the lower case alphabetic characters in the gray area. When the <b>SHIFT</b> key is pressed in the Alpha state, the upper case alphabetic characters on the key are produced. For example, press and release the Orange key, press and release the <b>SHIFT</b> key and then press the 4 key once to produce the letter 'G'.
BKSP	Backspace function. Space function when used with the Blue key.
CTRL (Control)	Press and release the CTRL key to activate the keypad alternate CTRL functions. The  icon appears in the Taskbar. Press the Blue key followed by the CTRL key to activate the keypad alternate ALT functions. The  icon appears in the Taskbar.
SHIFT	Press and release the SHIFT key to activate the keypad alternate SHIFT functions. The  icon appears in the Taskbar.
ENTER	Executes a selected item or function.
TAB	Move the focus to the next field in a window.
P1	Programmable key. When used with the Blue key, toggles the keypad backlight on and off.
P2	Programmable key. When used with the Blue key, controls the display brightness.

The keypad is color-coded to indicate the alternate function key (blue) values and the alternate ALPHA key (orange) values. See [Table 2-4](#) for the special character generation.

**Table 2-4** *Special Character Generation Map*

Special Character	Keypad
/ (forward slash)	Blue - Orange - 0
[ (open square bracket)	Blue - Orange - 2
] (close square bracket)	Blue - Orange - 3
\ (Backslash)	Blue - Orange - 4
` (apostrophe)	Blue - Orange - 5

**Table 2-4** Special Character Generation Map (Continued)

Special Character	Keypad
, (comma)	Blue - Orange - 6
. (period)	Blue - Orange - 7 or Orange - <b>TAB</b>
; (semi-colon)	Blue - Orange - 8
= (equal sign)	Blue - Orange - 9
- (dash)	Blue - Orange - <b>TAB</b>
! (exclamation point)	<b>Shift - 1</b>
@ (at sign)	<b>Shift - 2</b>
# (Pound sign)	<b>Shift - 3</b>
\$ (dollar sign)	<b>Shift - 4</b>
% (percent sign)	<b>Shift - 5</b>
^ (carat)	<b>Shift - 6</b>
& (ampersand)	<b>Shift - 7</b>
* (asterisk)	<b>Shift - 8</b>
( (open parenthesis)	<b>Shift - 9</b>
) (close parenthesis)	<b>Shift - 0</b>
' (single quote)	Blue - Orange - 1
" (double quote)	<b>Shift - Blue - Orange - 1</b>
? (question mark)	<b>Shift - Blue - Orange - 0</b>
{ (open curly bracket)	<b>Shift - Blue - Orange - 2</b>

**Table 2-4** Special Character Generation Map (Continued)

Special Character	Keypad
} (close curly bracket)	Shift - Blue - Orange - 3
 (pipe)	Shift - Blue - Orange - 4
~ (tilde)	Shift - Blue - Orange - 5
< (less than sign)	Shift - Blue - Orange - 6
> (greater than sign)	Shift - Blue - Orange - 7
: (colon)	Shift - Blue - Orange - 8
+ (plus sign)	Shift - Blue - Orange - 9
_ (underscore)	Shift - Blue - Orange - TAB

## Voice Only Keypad

The voice only keypad contains three programmable function keys.

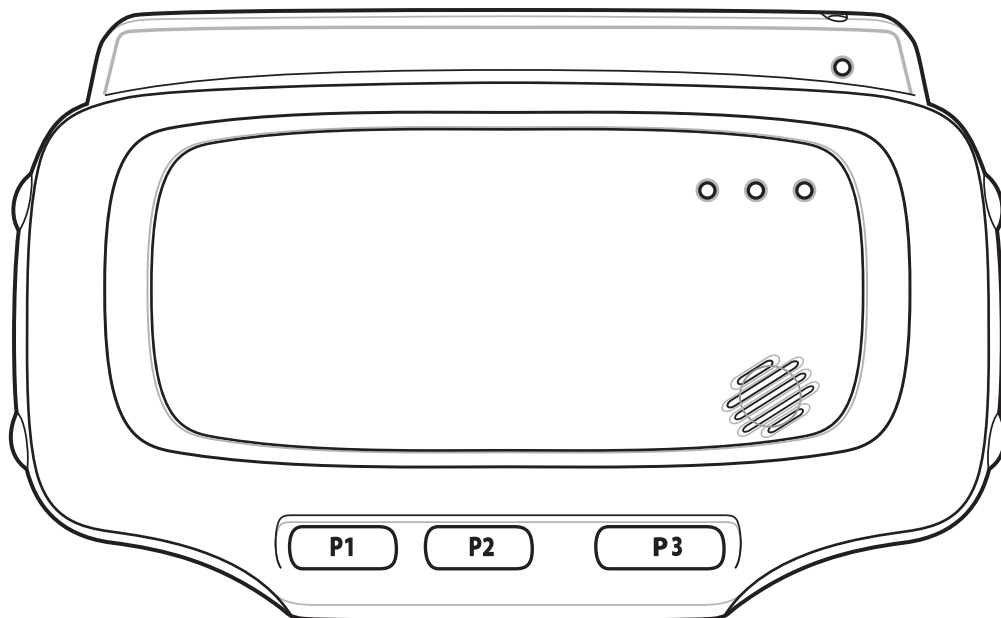

**Figure 2-5** Voice Only Keypad

## Display

- ✓ **NOTE** To view the software versions on the Voice Only WT41N0, the Voice Only WT41N0 must be connected to a host computer running remote desktop software. See the *WT41N0 Integrator Guide* for more information.

The wearable terminal is factory installed with the Windows CE 7.0 operating system. When the wearable terminal starts, it automatically launches the Start Up application.

- ✓ **NOTE** A customer specific application can be configured to automatically start-up and the Windows CE 7.0 desktop and Start Up application might not be visible or accessible.

## App Launcher Window

- ✓ **NOTE** App Launcher window is not available on the Voice Only WT41N0.

The **App Launcher** window allows the user to launch specific applications by using the keypad. Either scroll up and down using the arrow keys and select **Enter** to select an item or press the numeric key associated with the item. If the **App Launcher** window is closed, launch the **App Launcher** window by selecting **Start > Programs > WT41N0 Startup**.

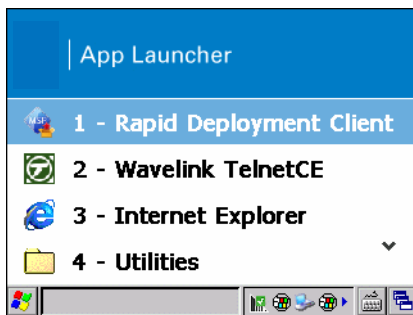

Figure 2-6 Start-up Window

Table 2-5 Start Up Item Descriptions

Item	Launch Number	Description
Rapid Deployment Client	1	Launches the Rapid Deployment application. Refer to the <i>WT41N0 Integrator Guide</i> for more information.
Wavelink TelnetCE	2	Launches the Wavelink CE Telnet client application.
Internet Explorer	3	Launches the Microsoft Pocket Internet Explorer application.
Utilities folder	4	Opens a sub-window that contains utilities, such as: Control Panel, File Explorer, BT Explorer and test applications.



**Table 2-5** Start Up Item Descriptions (Continued)

Item	Launch Number	Description
Demo Apps	5	Opens a sub-window that contains sample demonstration applications.
Exit	6	Closes the Start Up window.

## Windows CE 7.0 Desktop

The following paragraphs describe the Windows CE 7.0 desktop. Depending upon the customer's configuration of the wearable terminal, the desktop may not be available.

### Status Icons

The Taskbar at the bottom of the window displays the active programs, current time, battery status and communication status.

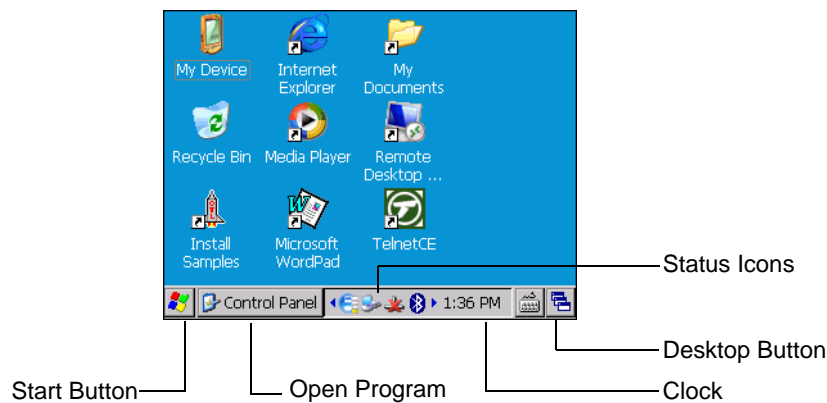













**Figure 2-7** Taskbar

Status icons are shown in the taskbar to indicate present status of the wearable terminal.

**Table 2-6** Status Icons

Status Icon	Description
	Indicates the current time. The clock can be toggled on and off. Select <b>Start &gt; Settings &gt; Control Panel &gt; Task and Start Menu</b> .
	This icon indicates that the main battery is charging or that the wearable terminal is operating on external power.
	Indicates that the battery is fully charged and the wearable terminal is running on external power.
	This icon is displayed when the memory backup battery level is low. Charge the battery.

**Table 2-6** Status Icons (Continued)

Status Icon	Description
	This icon indicates that the battery is fully charged (100% charged). The battery status icons provide the battery status in 10% increments from 10% to 100%.
	This displays when the terminal is connected to a host computer with ActiveSync.
	Wireless connection status icon. Indicates WLAN signal strength.
	Bluetooth radio is on.
	Bluetooth radio is off (StoneStreet stack only).
	Bluetooth radio is connected to another Bluetooth device (StoneStreet stack only).
	Indicates that the <b>SHIFT</b> key is selected.
	Indicates that the Blue key is selected.
	Indicates that the Orange key is selected.
	Indicates that the Gray key is selected.
	Indicates that the <b>CTRL</b> key is selected.
	Indicates that the <b>ALT</b> function is selected.
	Indicates that the DataWedge application is running.
	Indicates that the DataWedge application is idle.
	Indicates that the Remote Control software is connected to the wearable terminal.

















## Programs Menu



**NOTE** For the non-touch configurations, see [Using the Keypad to Navigate Applications on page 2-13](#) for instruction on navigating using the navigation pad.

From the **Start** menu, tap **Programs** to open the **Programs** menu. The programs installed on the wearable terminal with Windows CE display in the **Programs** menu.























**Table 2-7** Applications in the Programs Menu

Icon	Description	Icon	Description
	<b>Fusion Folder:</b> Open the Wireless Companion folder. See <a href="#">Chapter 4, Wireless Applications</a> for more information.		<b>BTScannerCtlPanel:</b> Sets the appropriate COM port when using a Bluetooth scanner.
	<b>Command Prompt:</b> Opens a DOS command prompt window.		<b>CtlPanel:</b> View and change wearable terminal settings such as: Scanner Parameters, Display Settings, Audio Settings, Printer Settings, Date and Time Settings, Touch Screen Settings, etc.
	<b>Internet Explorer:</b> Browse web sites.		<b>Media:</b> Play audio and video files.
	<b>Microsoft WordPad:</b> Use to read and write documents.		<b>MotoBTUI:</b> Use to set Bluetooth options and configuration.
	<b>MSP Agent:</b> Interacts with MSP agents to collect monitoring and asset information to enable the configuration, provisioning, monitoring and troubleshooting of the wearable terminal. Refer to the <i>WT41N0 Integrator Guide</i> for more information.		<b>Rapid Deployment Client:</b> Facilitates software downloads from a Mobility Services Platform Console FTP server to the wearable terminal. Refer to the <i>WT41N0 Integrator Guide</i> for more information.
	<b>Remote Desktop Connection:</b> Log into server type computers and use all the programs that are available on that computer.		<b>Samples:</b> Opens the <b>Sample Applications</b> window, when installed.
	<b>TelnetCE:</b> Opens the Wavelink Telnet client.		<b>WarmBoot:</b> Warm boots the wearable terminal.
	<b>Windows Explorer:</b> Organize and manage files on your device.		<b>WT41N0 Startup:</b> Launches the Startup application. Not available on the Voice Only WT41N0.





## Control Panel

Table 2-8 lists the applications in the **Control Panel**.

**Table 2-8** Programs on the Control Panel

Icon	Description	Icon	Description
	<b>Backlight:</b> Adjust the backlight brightness and power settings. Not available on the Voice Only WT41N0.		<b>Bluetooth:</b> Launches the BTE Explorer application. Available when StoneStreet One Bluetooth stack is enabled.
	<b>Certificates:</b> See information about certificates installed on the wearable terminal.		<b>DataWedge:</b> Sample scanning application. See <a href="#">Chapter 3, Data Capture</a> for more information.
	<b>Date/Time:</b> Change date, time and time zone information.		<b>Dialing:</b> Set dialing properties for modem communication and change telephony settings.
	<b>Display:</b> Change desktop background, appearance, backlight and brightness. Not available on the Voice Only WT41N0.		<b>Error Reporting:</b> Choose whether the WT41N0 collects software operation information to use if a serious error occurs.
	<b>Input Panel:</b> Switch input methods and set input options.		<b>Internet Options:</b> Controls how the WT41N0 connects to the internet.
	<b>IST Settings:</b> Sets the appropriate settings for configuring the WT41N0's Interactive Sensor Technology.		<b>Keyboard:</b> Change keyboard repeat delay and rate.
	<b>Keypad:</b> Adjust the keypad brightness and power settings. Not available on the Voice Only WT41N0.		<b>Mouse:</b> Adjust double-click sensitivity for both the speed and timing.
	<b>Legal Notice:</b> Displays software licenses.		<b>MotoBTUI:</b> Launches the MotoBTUI application. Available only when the Microsoft Bluetooth stack is enabled.
	<b>Network and Dial-up Connections:</b> Connect to other computers, networks and the Internet using a modem.		<b>Owner:</b> Change owner's personal profiles.
	<b>Password:</b> Set a password for the wearable terminal. Not available on the Voice Only WT41N0.		<b>PC Connection:</b> Change settings for connectivity of a host computer.
	<b>Power:</b> View and control wearable terminal power settings.		<b>Regional Settings:</b> Change how numbers, currencies, dates and times appear.
	<b>Remove Programs:</b> Remove programs installed on the wearable terminal.		<b>Simultaneous Audio:</b> Route audio output to more than one audio output device.

**Table 2-8** Programs on the Control Panel (Continued)

Icon	Description	Icon	Description
	<b>Stylus:</b> Calibrate the touch screen and adjust double-tap timing. Not available on the Voice Only WT41N0.		<b>System:</b> View system information and change memory settings.
	<b>System Info:</b> View information on the wearable terminal's system components.		<b>USBConfig:</b> Configure the wearable terminal USB port.
	<b>Volume &amp; Sounds:</b> Select the type of actions for which to hear sounds and customize notifications for different events.		

## Using the Keypad to Navigate Applications

✓ **NOTE** Not available on the Voice Only configuration.

On wearable computers without touch-enabled screens navigation and control of an application is performed using the keypad.

### Key Combinations

The wearable terminal uses special key combinations to easily navigate applications. [Table 2-9](#) lists the key combinations required to perform various application navigation and control functions.

**Table 2-9** Key Combinations

Action Key	Combination
Access the Start menu on the taskbar	<b>CTRL - ESC</b>
Switch fields within an application	<b>TAB</b>
Close windows or cancel operations on some applications	<b>ESC</b> or <b>ALT - F4</b>
Access the Task Manager	<b>ALT - TAB</b>
Switches to the next window or desktop	<b>ALT - ESC</b>
Access a menu bar in an application	<b>ALT - CTRL</b>
Press a button or select a check box in an application	<b>TAB</b> until the item is highlighted then <b>BKSP.</b>
Display a pop-up context menu	<b>ALT - ENTER</b>
Close the Remote Desktop Connection application	<b>ALT - X</b>
<b>Media Player</b>	
Play	<b>ENTER</b>
Pause	<b>CTRL - P</b>
Stop	<b>CTRL - S</b>

**Table 2-9** Key Combinations (Continued)

Action Key	Combination
Mute	CTRL - M
Repeat	CTRL - R
Shuffle	CTRL - H
Full Screen	ALT - ENTER

Throughout this guide you will be instructed to select an item. You must use a key combination to select that item. For example:

To perform:

“Select **Start > Programs > Windows Explorer**”

1. Press **CTRL** and then **ESC** to open the **Start** menu.
2. Press the up arrow until the **Programs** item is highlighted.
3. Press the Blue key and the down arrow to open the **Programs** sub-menu.
4. Press the down arrow until **Windows Explorer** is highlighted.
5. Press **ENTER** key to launch **Windows Explorer**.

## Selecting Items

When using the navigation keys to perform tasks in an application, the active item is highlighted using either a color background and/or a dashed box.

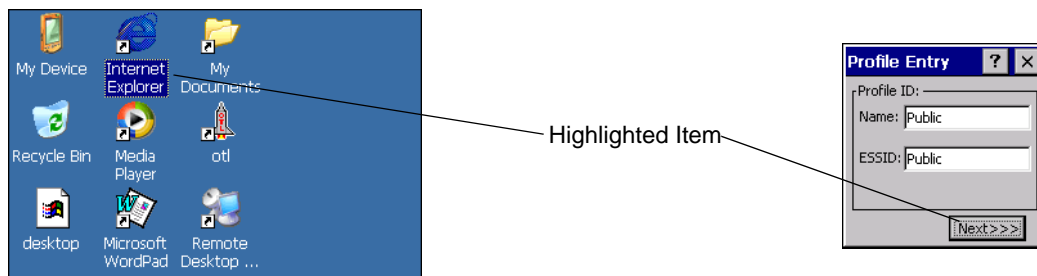

**Figure 2-8** Highlighted Items

## Navigating Menus

Most applications have drop-down menus to perform specific functions. Use the key combination **ALT - CTRL** to open a menu. Once the menu is open, use the up and down navigation keys to move up and down the menu and use the left and right navigation keys to move to the next menu item or open a sub-menu. When moving through a menu, items are highlighted. Once an item is highlighted, press the **ENTER** key to select that item.

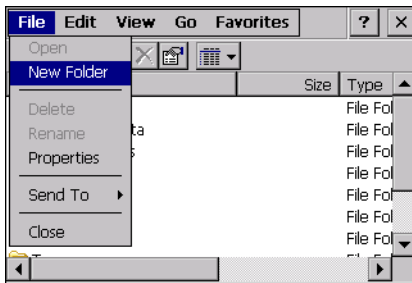

Figure 2-9 Navigating Menus

## Navigating Tabs

Some applications contain multiple pages with tabs indicating each page. Use the **TAB** key to highlight the tab. A dashed box appears around the tab name. Use the left and right navigation keys to move to the next or previous tab.

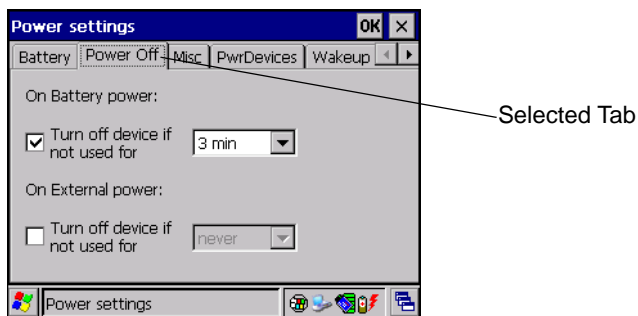

Figure 2-10 Navigating Tabs

## Navigating Fields

To navigate from one field to another, press the **TAB** key. Repeated pressing of the **TAB** key cycles the highlighted cursor through the fields in the window.

## Selecting Checkboxes and Radio Buttons

To select or deselect checkboxes and radio buttons press the **TAB** key until the field is highlighted. Press Blue key- **BKSP** (SPACE) to select or deselect the checkbox or radio button.

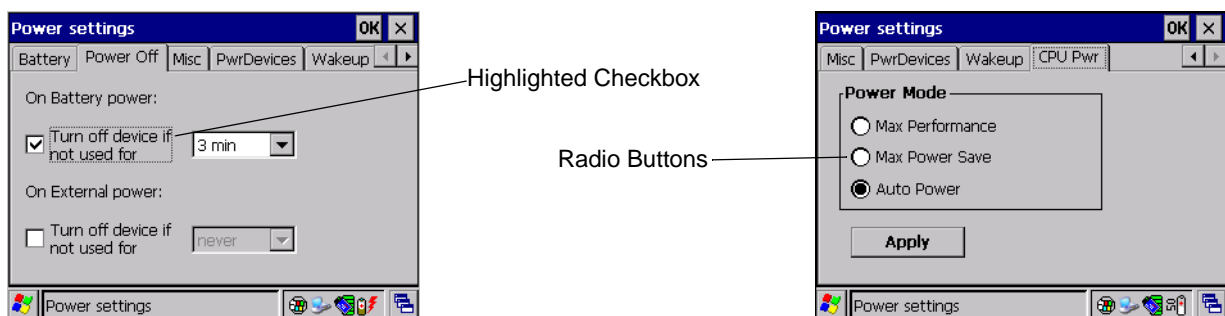

Figure 2-11 Selecting a Checkbox or Radio Button

## Selecting Items in a List

Use a combination of key sequences to select items in a folder or list.

To select continuous items in a folder or list:

1. Open the folder or list.
2. Use the scroll keys to move to the first item to select.
3. Press **SHIFT** - scroll key (either up or down) to select the next item.
4. Repeat the **SHIFT** - scroll key combination to select remaining items.
5. Perform the desired function.

To select multiple items in a folder or list:

1. Open the folder or list.
2. Use the scroll keys to move to the first item.
3. Press **CTRL** - scroll key to move within the list. The item name is outlined.
4. Repeat step 3 to move to the desired item.
5. Press **SPACE** to highlight the item.
6. Repeat steps 3 through 5 until all items are selected.
7. Perform the desired function.

## Screen Calibration

✓ **NOTE** Not available on the Voice Only and non-touch configurations.

To calibrate the touch screen so the cursor on the touch screen aligns with screen taps:

1. Press **Start** > **Settings** > **Control Panel** > **Stylus** icon > **Calibration** tab > **Recalibrate** button.
2. Carefully press and briefly hold on the center of the **Calibration** screen target. Repeat the procedure as the target moves and stops at different locations on the screen. This enters the new calibration settings.



Calibration Screen



Confirm Calibration Screen

**Figure 2-12** Calibration Screen

3. Once all of the new calibration settings are input, tap the screen or press the **ENTER** button to save the new calibration settings. Press **ESC** to discard the new calibration settings.



## Adjusting the Display Brightness

To adjust the display brightness:

1. Press **Blue** key - **P2**. The brightness control box appears.

2.



**Figure 2-13** *Brightness Control Box*

3. Use the navigation keys adjust the brightness.
4. After three seconds of inactivity, the settings are saved and the box disappears.

## Special Character Keypad

✓ **NOTE** The Special Character Keypad is only available on non-touch screen configurations with a display.

The wearable terminal contains an on-screen Special Character keypad that allows users to enter alphanumeric and special characters. The keypad looks and functions like a standard keyboard.

To display the Special Character keypad, press the ★ key on the keyboard.



**Figure 2-14** *Special Character Keypad - Alphanumeric Layer*

Use the arrow keys on the keyboard to move the yellow box to highlight a key on the Special Character keypad. The arrow keys wrap to the next row or column as you navigate with the keys.

To select a character, press the **Enter** key on the wearable terminal.

If the **Enter** or arrow keys need to be used by the application instead of the Special Character keypad, press **Esc** followed by the arrow or **Enter** key. This sends the key to the application instead of the Special Character keypad.

Press the **ABC** key on the Special Character keypad to switch between the alphanumeric layer and the character layer.

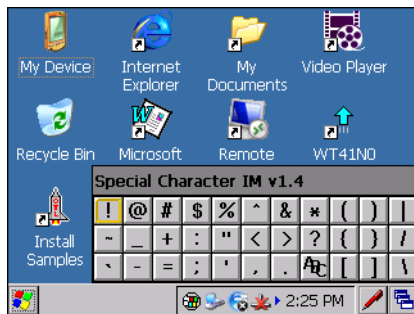

**Figure 2-15** Special Character Keyboard - Character Layer

Navigate the keypad in the same manner as described above. To return to the alphanumeric layer, press the **CH** key on the keypad.

Pressing **CAP** or **SH** switches the keypad to the upper case alphanumeric keypad.

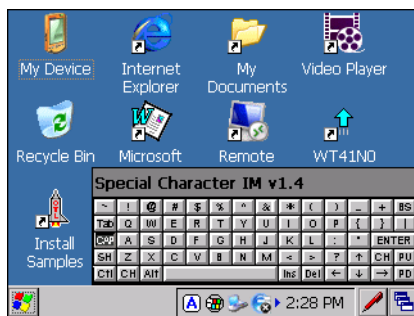

**Figure 2-16** Special Character Keyboard in Upper Case Alphanumeric Mode

Press the ★ key to close the Special Character keypad.

## Locking the WT41N0

✓ **NOTE** Not available on Voice Only WT41N0 configurations.

Locking the WT41N0 turns off keyboard and touch screen functionality. When enabled, the WT41N0 locks after a programmed time out setting. Refer to the WT41N0 Integrator Guide for information on setting the lock time value.

### Un-locking with Simple PIN

When the WT41N0 locks, the **Lock** screen appears.

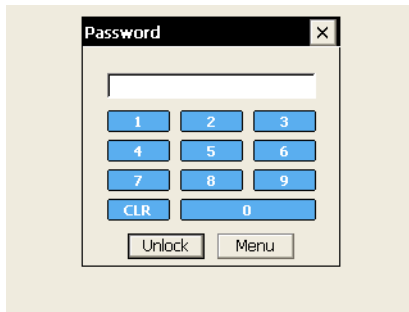

**Figure 2-17** Simple PIN Lock Screen

Enter the PIN to un-lock the WT41N0.

Select the **Unlock** button to unlock the WT41N0.

## Un-locking with Strong Password

When the WT41N0 locks, the **Lock** screen appears.



**Figure 2-18** Strong Password Lock Screen

Enter the strong password and then select **Unlock**.

---

## Resetting the Wearable Terminal

There are two types of resets, warm boot and cold boot. A warm boot restarts the wearable terminal by closing all running programs.

A cold boot also restarts the wearable terminal, but erases all stored records and entries in RAM. Data saved in flash memory or a memory card is not lost. In addition it returns formats, preferences and other settings to the factory default settings.

Perform a warm boot first. This restarts the wearable terminal and saves all *stored* records and entries. If the wearable terminal still does not respond, perform a cold boot.

### Performing a Warm Boot

Hold down the Power button for approximately five seconds. As soon as the wearable terminal starts to perform a warm boot release the Power button.

## Performing a Cold Boot

A cold boot restarts the wearable terminal and erases all user stored records and entries that are not saved in flash memory (Application and Platform folders). *Never perform a cold boot unless a warm boot does not solve the problem.*



**NOTE** Any data previously synchronized with a computer can be restored during the next ActiveSync operation.

To perform a cold boot on a WT41N0 press and simultaneously hold the **1**, **9** and Power button. Do not hold down any other keys or buttons. The wearable terminal initializes.

To perform a cold boot on a Voice Only WT41N0 press and simultaneously hold the **P1** and **P2** keys and the Power button. The wearable terminal initializes.

## Waking the Wearable Terminal

The wake up conditions define what actions wake up the wearable terminal after it has gone into suspend mode. The wearable terminal can go into suspend mode by either pressing the Power button or automatically by control panel time-out settings. These settings are configurable and the factory default settings are shown in [Table 2-10](#). Select **Start > Settings > Control Panel > Power icon > Wakeup** tab.

**Table 2-10** *Wakeup Default Settings*

Condition for Wakeup	Power Button	Automatic Time-out
AC power is applied.	No	Yes
Accessory is connected.	No	Yes
Wearable terminal is connected to a USB device.	No	Yes
Wearable terminal is disconnected from a USB device.	No	Yes
A key is pressed.	No	Yes
Screen Touch (only on touch screen configurations)	No	No
Trigger is pressed.	No	Yes

✓ **NOTE** If the battery is removed and replaced, the only way to wake up the terminal is by pressing the Power button.

## Battery Health

A battery becomes unhealthy when the usage reaches the pre-defined threshold value (end of usable life). The health of the battery can be viewed on the wearable terminal Power applet. Select **Start > Settings > Control Panel > Power icon > BatteryMgmt** tab.

**Table 2-11** *BatteryMgmt Window*

Item	Description
State of Health	Indicates the current state of the battery (Healthy or Unhealthy).
Battery Usage Indicator	Indicates the usage of the battery.
Battery Usage Threshold	Indicates the usage indicator threshold.
Battery Serial #	Displays the serial number of the battery.

For information on changing the Battery Usage Threshold, refer to the *WT41N0 Integrator Guide*.

---

## Interactive Sensor Technology

This section describes the functionality of the Interactive Sensor Technology (IST) feature on the WT41N0.

The IST supports the following features.

- Power Management – manage power by configuring IST to control switching on/off the backlight, control suspend mode of the WT41N0 by monitoring motion and orientation.
- Display Orientation – switch the screen orientation to either landscape or portrait depending on the WT41N0 orientation.
- Free Fall Detection – monitors free fall duration and records the time and type of the drop event.

### Free Fall Detection

IST continuously monitors gravitational force on the WT41N0 according to its current position. When the WT41N0 free falls, IST detects the absence of gravitational force and records the event data if it detects a free fall more than 450 ms, which may indicate nearly a one meter drop. This data can be used as an indicator of potential abuse or misuse.

---

## Simultaneous Audio

Use **Simultaneous Audio** to route audio output to more than one audio output device (speaker, Bluetooth headset or wired headset).

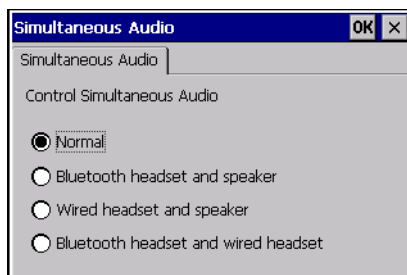

Figure 2-19 Simultaneous Audio Window

### Normal

By default the WT41N0 is set to **Normal**. Audio is heard on the output device as follows:

- If no headset is connected, audio is heard through the speaker.
- If a wired headset is connected, audio is heard through the wired headset.
- If a Bluetooth headset is connected and paired, audio is heard through the Bluetooth headset.
- If both a wired headset and a Bluetooth headset are connected:
  - If the Bluetooth headset is paired and connected, audio is heard through the Bluetooth headset.
  - If the Bluetooth headset is paired but not connected, audio is heard through the wired headset.

### Bluetooth headset and Speaker

Select this option to route audio to both the speaker and the Bluetooth headset.

If user has not paired and connected the Bluetooth headset before selecting this option, an error message will display and Normal mode is selected.

### **Wired Headset and Speaker**

Select this option to route audio to both the speaker and the wired headset.

If user has not connected a wired headset before selecting this option, an error message displays and Normal mode is selected.

### **Bluetooth Headset and Wired Headset**

Select this option to route audio to both the wired headset and the Bluetooth headset.

If user has not paired and connected the Bluetooth headset before selecting this option, an error message displays and Normal mode is selected.

If user has paired and connected the Bluetooth headset and not connected the wired headset before selecting this option, no error message displays and **Bluetooth headset wired headset** option is selected.

- ✓ **NOTE** When the user has selected any of the options except **Normal**, the remaining two options are disabled. The user has to select **Normal** before changing to any other option.





# CHAPTER 3 DATA CAPTURE

---

## Introduction

The wearable terminal can be used with the following optional data capture accessories:

- RS309 laser scanner
- RS409 laser scanner
- RS419 laser scanner
- RS507 Hands-free imager
- RS5000 imager.

---

## Laser Scanning

Wearable terminals with an optional RS309, RS409 or RS419 laser scanner have the following features:

- Reading of a variety of bar code symbologies, including the most popular linear and 1D code types.
- Advanced intuitive laser aiming for easy point-and-shoot operation
- Adaptive scanning (RS419 only).

## Scanning Bar Codes



**NOTE** Scanning procedures depend on the application and wearable terminal configuration. An application may use different scanning procedures from the one listed below.

1. Connect one of the scanning options to the wearable terminal. See [Chapter 5, Accessories](#) for more information.
2. Ensure that a scan enabled application is loaded or DataWedge is enabled (see [DataWedge on page 3-6](#) for more information).
3. Press the trigger.

4. Aim the scan beam at the bar code.

Ensure the red scan beam covers the entire bar code. The Decode LED lights red to indicate that scanning is in process, then lights green and a beep sounds, by default, to indicate the bar code was decoded successfully.



**Figure 3-1** *Laser Scanner Aiming Pattern*

5. Release the trigger.

### Scanning Tips

Optimal scanning distance varies with bar code density and scanner optics.

- Hold the scanner farther away for larger symbols.
- Move the scanner closer for symbols with bars that are close together.

### Adaptive Scanning

The RS419 contains the adaptive scanning feature that automatically adjusts the scan beam width for rapid and easy scanning of bar codes from near contact to more than 200 inches away.

By default the RS419 is set to wide scan beam width. When the user presses the trigger, the RS419 determines the distance from the bar code. For close bar codes the RS419 sets a wide beam width and for far bar codes it sets a narrow beam width. The RS419 uses distance, bar code type and material to determine the correct scan beam width.

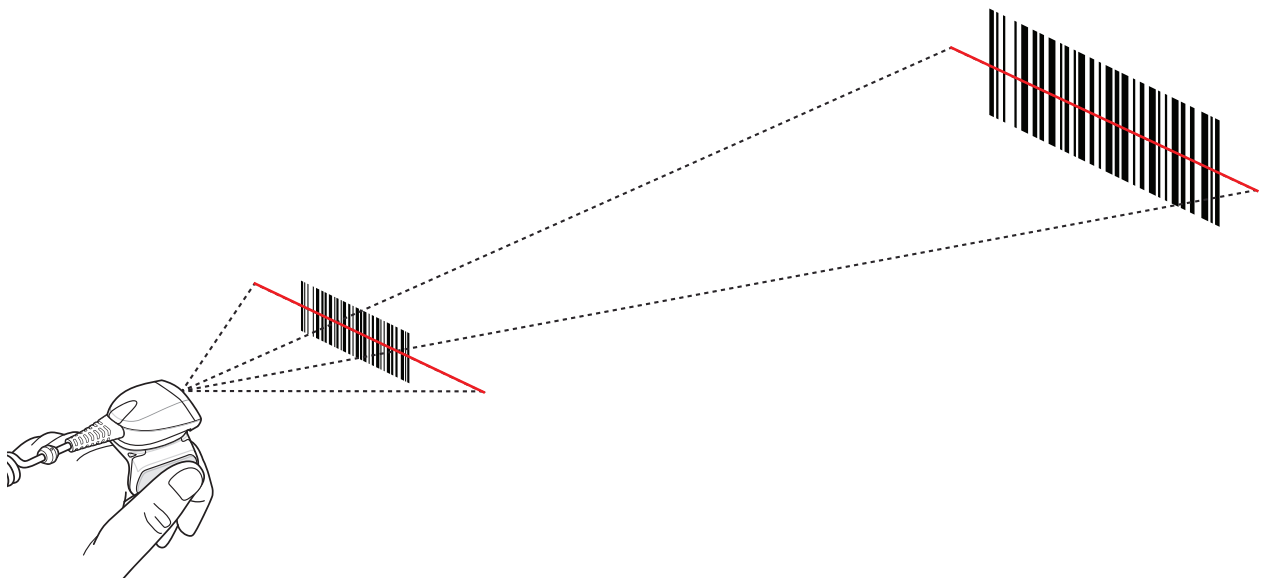

**Figure 3-2** *RS419 Adaptive Scanning*

---

## Imaging

The wearable terminal with an optional RS507 or RS5000 imager has the following features:

- Omnidirectional (360°) reading of a variety of bar code symbologies, including the most popular linear, postal, PDF417, and 2D matrix code types.
- Advanced intuitive aiming for easy point-and-shoot operation.

The imager uses imaging technology to take a picture of a bar code, stores the resulting image in its memory, and executes state-of-the-art software decoding algorithms to extract the bar code data from the image.

## Operational Modes

The wearable terminal with optional RS507 and RS5000 imager supports two modes of operation. Activate each mode pressing the **Scan** button.

- **Decode Mode:** In this mode, the imager attempts to locate and decode bar codes within its field of view. The imager remains in this mode as long as the user holds the scan button, or until it decodes a bar code.



**NOTE** To enable Pick List Mode, use the Control Panel applet or DataWedge. Pick List can also be set in an application using a API command.

- **Pick List Mode:** This mode allows the user to selectively decode a bar code when more than one bar code is in the imager field of view. To accomplish this, move the aiming crosshair center dot over the required bar code to decode only that bar code. This feature is ideal for pick lists containing multiple bar codes and manufacturing or transport labels containing more than one bar code (either 1D or 2D).

## Imager Scanning

Ensure that a scan-enabled application is loaded or DataWedge is enabled (see [DataWedge on page 3-6](#) for more information).

### RS507 Scanning

1. Press and hold the scan button.

The red laser aiming pattern turns on to assist in aiming. Ensure the cross-hair is on top of the bar code.

The Decode LED lights red to indicate that scanning is in process, then lights green and a beep sounds, by default, to indicate the bar code was decoded successfully. Note that when the RS507 is in Pick List Mode, the imager does not decode the bar code until the crosshair center dot touches the bar code.

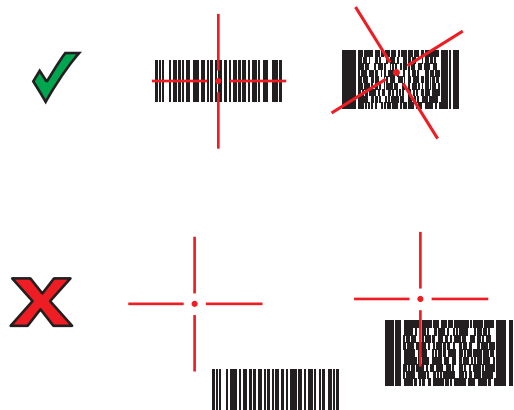

**Figure 3-3** *RS507 Imager Aiming Pattern*



**Figure 3-4** *RS507 Pick List Mode with Multiple Bar Codes*

2. Release the scan button.

### RS5000 Scanning

1. Press the scan trigger and aim the RS5000 at a bar code.
2. Ensure the bar code is within the area formed by the aiming pattern. The aiming dot is used for increased visibility in bright lighting conditions.



**Figure 4** *RS5000 Aiming Pattern*



**Figure 5** RS5000 Pick List Mode with Multiple Bar Codes

- If the decode is successful the LED lights green. The terminal beeps if programmed accordingly.

✓ **NOTE** Imager decoding usually occurs instantaneously. The RS507 or RS5000 repeats the steps required to take a digital picture (image) of a poor or difficult bar code as long as the scan button remains pressed.

---

## Scanning Considerations

Typically, scanning is a simple matter of aim, scan/decode and a few quick trial efforts master it. However, two important considerations can be used to optimize any scanning performance:

- Range

Any scanning device decodes well over a particular working range — minimum and maximum distances from the bar code. This range varies according to bar code density and scanning device optics.

Scanning within range brings quick and constant decodes; scanning too close or too far away prevents decodes. Move the scanner closer and further away to find the right working range for the bar codes being scanned. However, the situation is complicated by the availability of various integrated scanning modules. The best way to specify the appropriate working range per bar code density is through a chart called a decode zone for each scan module. A decode zone simply plots working range as a function of minimum element widths of bar code symbols. Refer to the *WT41N0 Integrator Guide* for decode zones for the optional data capture options.

- Angle

Scanning angle is important for promoting quick decodes. When laser beams reflect directly back into the scanner from the bar code, this specular reflection can “blind” the scanner.

To avoid this, scan the bar code so that the beam does not bounce directly back. But don’t scan at too sharp an angle; the scanner needs to collect scattered reflections from the scan to make a successful decode. Practice quickly shows what tolerances to work within.

✓ **NOTE** Contact the Zebra Global Support Center if chronic scanning difficulties develop. Decoding of properly printed bar codes should be quick and effortless.

---

## Setting Up the RS507 Hands-free Imager

An RS507 Hands-free Imager can be used with the WT41N0 to capture bar code data.

To set up the wearable terminal and RS507:

- Enable DataWedge to use the Bluetooth SSI Scanner Driver. See [Enable DataWedge on page 3-6](#).
- Select **Start > Programs > MotoBTUI**.

### 3. Select **Pairing Barcode**.



**Figure 3-1** Sample Pairing Bar Code

4. Scan the pairing bar code. Note that when using the Voice Only WT41N0, use the Remote Control software to display the pairing bar code on a computer monitor. Refer to the *WT41N0 integrator Guide* for more information.
5. Point the RS507 to the bar code. The RS507 reads the bar code and begins pairing with the wearable terminal. If required, enter PIN (12345). Tap **Yes**.

Refer to the *RS507 Hands-free Imager Product Reference Guide* for more information on the RS507.

---

## Setting Up the RS5000 Imager

An RS5000 Imager can be used with the WT41N0 to capture bar code data.

To set up the wearable terminal and RS5000 see [RS5000 Imager on page 5-12](#).

Refer to the *RS5000 Imager Quick Start Guide* for more information on the RS5000.

---

## DataWedge

DataWedge is an application that reads data from a scanning source, processes the data and sends the data to an application as if the user is entering it on a keyboard. By default, DataWedge is disabled. To use DataWedge

### Enable DataWedge

To enable DataWedge:

1. Select **Start > Settings > Control Panel > DataWedge** icon.
2. Select **Basic Configuration** and then press **ENTER**.
3. Select **1. Scanner input** and then press **ENTER**.
4. Select one of the following:
  - a. Press **1** to select **1. SSI Scanner Driver** for the RS5000 imager.
  - b. Press **2** to select **2. Bluetooth SSI Scanner Driver** for the RS507 Hands-free Imager.

- Press **1** to select **1. Enabled**.

For the RS5000 imager, press **1** to uncheck **1. Enabled** and press **1** to check **1. Enabled** again. This disables the Bluetooth scanner so the RS5000 starts faster.

- Press **0**.
- Press **0**.
- Press **0**.
- Select **OK** to exit.

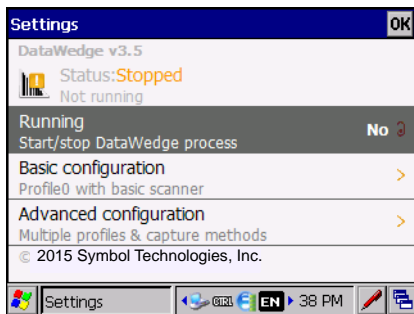

**Figure 3-2** *DataWedge Stopped*

- Select **Running** and press **ENTER** to start the DataWedge process. The **DataWedge Status** changes to **Ready**.

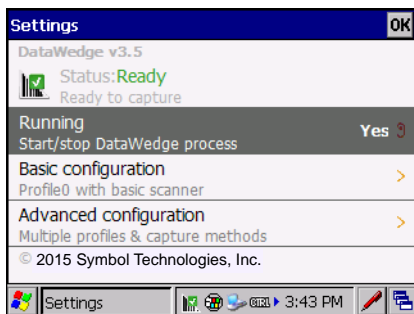

**Figure 3-3** *DataWedge Running*

- Press **ESC** to exit.

## Disable DataWedge

To disable DataWedge:

- Select **Start > Settings > Control Panel > DataWedge** icon.
- Select the **Running** option to end the DataWedge process. The **DataWedge Status** changes to **Stopped**.
- Select **OK**.

## Using DataWedge to Read bar Codes

To read bar codes with DataWedge:

- Enable **DataWedge**.

2. Open an application and select a text box or field for entering the bar code data.
3. Use one of the optional scanners and capture the bar code data. The data appears in the text box.



# CHAPTER 4 WIRELESS APPLICATIONS

## Introduction

Wireless Local Area Networks (LANs) allow mobile computers to communicate wirelessly and send captured data to a host device in real time. Before using the wearable terminal on a WLAN, the facility must be set up with the required hardware to run the wireless LAN and the wearable terminal must be configured. Refer to the documentation provided with the access points (APs) for instructions on setting up the hardware.

✓ **NOTE** 802.11d is enabled by default. When enabled, the AP must be configured the same in order to connect.

To configure the wearable terminal, a set of wireless applications provide the tools to configure and test the wireless radio in the wearable terminal. Refer to the *Wireless Fusion Enterprise Mobility Suite User Guide* for information on configuring wireless profiles. Go to <http://www.zebra.com/support> for the latest version of this guide. See *Software Versions on page x* to determine the Fusion version on the wearable terminal.

Select the **Signal Strength** icon or press **ALT - W** to display the **Wireless Launcher** menu.

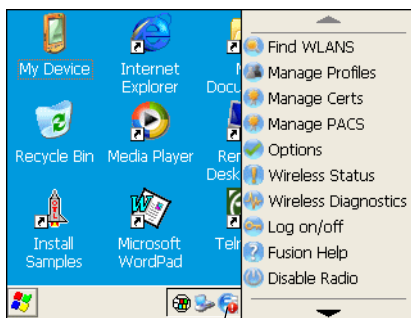

Signal Strength Icon

**Figure 4-1** *Wireless Launcher Menu*

Many of the items in the menu invoke one of the Fusion applications. These menu items and their corresponding applications are summarized in *Table 4-1*.

**Table 4-1** *Supported Applications*

Application	Description
Find WLANs	Invokes the <b>Find WLANs</b> application which displays a list of the WLANs available in your area.
Manage Profiles	Invokes the <b>Manage Profiles</b> application (which includes the <b>Profile Editor Wizard</b> ) to manage and edit your list of WLAN profiles.
Manage Certs	Invokes the <b>Certificate Manager</b> application which allows you to manage certificates used for authentication.
Manage PACs	Invokes the <b>PAC Manager</b> application which helps you manage the list of Protected Access Credentials used with EAP-FAST authentication.
Options	Invokes the <b>Options</b> application which allows you to configure the Fusion option settings.
Wireless Status	Invokes the <b>Wireless Status</b> application which allows you to view the status of the current wireless connection.
Wireless Diagnostics	Invokes the <b>Wireless Diagnostics</b> application which provides tools with which to diagnose problems with the wireless connection.
Log On/Off	Invokes the <b>Network Login</b> dialog which allows you to log on to a particular profile or to log off from the currently active profile.
Fusion Help	Invokes Fusion Help application which provides on-device Fusion Help





Additional **Wireless Launcher** menu entries include:

- Enable/Disable Radio
- Hide Menu
- Exit.



## Signal Strength Icon

The **Signal Strength** icon in the task tray indicates the mobile computer's wireless signal strength as follows:

**Table 4-2** *Signal Strength Icons Descriptions*

Icon	Status	Action
	Excellent signal strength	WLAN network is ready to use.
	Very good signal strength	WLAN network is ready to use.
	Good signal strength	WLAN network is ready to use.
	Fair signal strength	WLAN network is ready to use. Notify the network administrator that the signal strength is only "Fair".

**Table 4-2** *Signal Strength Icons Descriptions (Continued)*

Icon	Status	Action
	Poor signal strength	WLAN network is ready to use. Performance may not be optimum. Notify the network administrator that the signal strength is "Poor".
	Out-of-network range (not associated)	No WLAN network connection. Notify the network administrator.
	The WLAN radio is disabled.	The WLAN radio is disabled. To enable, choose <b>Enable Radio</b> from the <b>Wireless Applications</b> menu.
None	The Wireless Launcher application was exited.	The <b>Wireless Launcher</b> application has been closed. See the Fusion Functions paragraphs below for how to restart the <b>Wireless Launcher</b> .

## Turning Off the Radio

By default, the WLAN radio is on. To turn off the WLAN radio select the Signal Strength icon or press **ALT - W** to open the Wireless Launcher menu. Select **Disable Radio** and press **ENTER**.  appears indicating that the radio is disabled (off).

**Figure 4-2** *Signal Strength Icon*

To turn the radio back on, select the Signal Strength icon or press **ALT - W** to open the Wireless Launcher menu. Select **Enable Radio** and press **ENTER**.

## Minimum Setup

Below is a list of the minimum effort to achieve a wireless connection. Note that there are many discrete nuances that may affect the performance of your wireless connection that might be missed if not consider carefully.

Create a profile. Refer to the *Wireless Fusion Enterprise Mobility User Guide* for specific information.

1. Find out from the IT administrator what the connection settings should be (Extended Service Set Identifier (ESSID), Enterprise or Personal, authentication type, tunnel type, certificate requirements, Protected Access Credentials (PAC) requirements). Note that not all of the items listed may be relevant.
2. Create the profile using the information provided by the IT administrator.
3. Enter the **Manage Profile** screen, select the profile (press and hold), and select the **Connect** option in the context menu that appears.



# CHAPTER 5 ACCESSORIES

## Introduction

The wearable terminal accessories provide a variety of product support capabilities. Accessories include cradles, cables and scanners. [Table 5-1](#) lists the major accessories available for the wearable terminal:

**Table 5-1** *Wearable Terminal Accessories*

Accessory	Description
Single Slot USB Cradle	Charges the wearable terminal main battery and a spare battery. It also synchronizes the wearable terminal with a host computer through a USB connection.
Four Slot Ethernet Cradle	Charges up to four wearable terminals (with main battery installed) and provides communication through an Ethernet connection.
Four Slot Spare Battery Charger	Charges up to four spare batteries.
RS409 Scanner	Provides 1D scanning capability (Standard and Extended Cable configurations).
RS419 Scanner	Provides 1D scanning capability (Standard and Extended Cable configurations).
RS309 Scanner	Provides 1D scanning capability.
RS507 Scanner	Provides wired or wireless imaging capability.
RS5000 Scanner	Provides wired imaging capability.
Wrist Mount	Provides a means for wearing the wearable terminal on the arm for hands-free applications.
Hip Mount	Provides a means for wearing the wearable terminal on a belt for hands-free applications.
Headset	For audio playback/recording during voice-enabled applications.
Headset Adapters	Connect an optional headset to the wearable terminal.

**Table 5-1** *Wearable Terminal Accessories (Continued)*

Accessory	Description
Replacement Batteries	Standard Capacity Battery: 2400 mAh (minimum) Extended Capacity Battery: 4800 mAh (minimum)
Standard Capacity Battery Freezer Pouch	Allows the user to use the wearable terminal with standard capacity battery in a freezer environment on the hip or wrist for use in voice picking applications.
Extended Capacity Battery Freezer Pouch	Allows the user to use the wearable terminal with extended capacity battery in a freezer environment on the hip or wrist for use in voice picking applications.
USB Adapter	Connects the Single-slot cradle to USB hubs, mice, keyboards and memory. The adapter has a USB mini-A connector on the cradle side and a USB A Female connector on the other side.
Connector Shroud	Protects the connector of an accessory that connects to the wearable computer.
Screen Protectors	Package of 3 screen protectors.
Arm Sleeve	Extra layer sleeve to wear under wrist mount for extra comfort and hygiene.
RCH51 Rugged Cabled Headset	Enables hands-free voice-directed mobility communication. An audible mono headset with noise cancelling boom microphone helps survive harsh environments.
Software	<i>Enterprise Mobility Developer Kits</i> available at: <a href="http://www.zebra.com/support">http://www.zebra.com/support</a> .
	Device Configuration Package (DCPforWT41N0c70) and Platform SDK (PSDK41N0c570) for WT41x0, available at: <a href="http://www.zebra.com/support">http://www.zebra.com/support</a>

## Single Slot USB Cradle



**CAUTION** Ensure that you follow the guidelines for battery safety described in [Battery Safety Guidelines on page 6-3](#).

This section describes how to use a Single Slot USB cradle ([Figure 5-1](#)) with the wearable terminal. For USB communication setup procedures refer to the *WT41N0 Integrator Guide*.

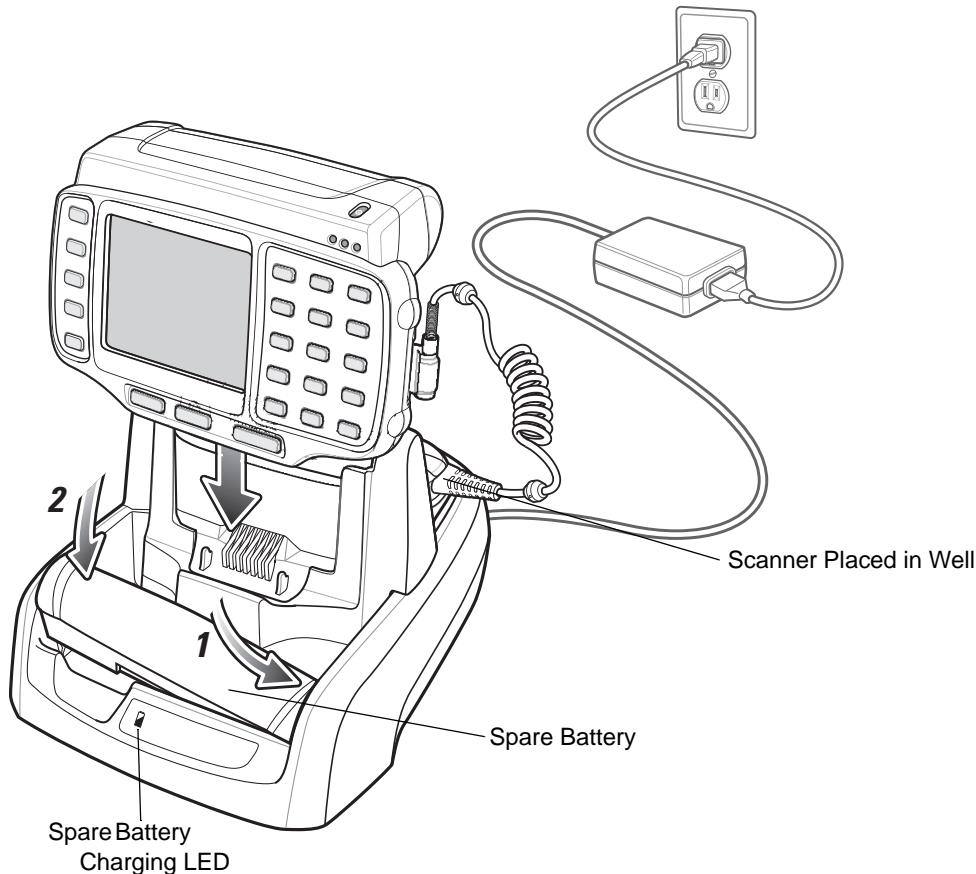

**Figure 5-1** Single Slot USB Cradle

The Single Slot USB Cradle:

- Provides 5.4 VDC power for operating the wearable terminal.
- Provides USB port for data communication between the wearable terminal and a host computer or other serial devices (e.g., a printer).

✓ **NOTE** The normal function of the product may be disturbed by Strong Electro Magnetic Interference (for example, static electricity). If so, simply remove and re-insert the terminal to resume normal operation. In case the function does not resume, please use the product in another location.

- Synchronizes information between the wearable terminal and a host computer. (With customized or third party software, it can also be used to synchronize the wearable terminal with corporate databases.)
- Charges the wearable terminal's battery and a spare battery.
- Provides a location for storing a scanner when a wearable terminal is docked in the cradle.

## Battery Charging Indicators

The Single Slot USB cradle can charge the wearable terminal's main battery and a spare battery simultaneously.

The wearable terminal's amber Charge Status LED indicates the status of the battery charging in the wearable terminal. See [Table 1-2 on page 1-8](#) for charging status indications.

The amber Spare Battery Charging LED on the cradle (see [Figure 5-1 on page 5-3](#)) indicates the status of the spare battery charging in the cradle. See [Table 5-2](#) for charging status indications. The standard capacity battery fully charges in less than four hours and the extended capacity battery fully charges in less than eight hours.

**Table 5-2** Spare Battery LED Charging Indicators

Spare Battery LED (on cradle)	Indication
Off	No spare battery in well; spare battery not placed correctly; cradle is not powered.
Fast Blinking Amber	Charging error: <ul style="list-style-type: none"> <li>• Temperature is too low or too high.</li> <li>• Charging has gone on too long without completing (typically eight hours).</li> </ul>
Slow Blinking Amber	Spare battery is charging.
Solid Amber	Charging complete.



## Four Slot Ethernet Cradle



**CAUTION** Ensure that you follow the guidelines for battery safety described in [Battery Safety Guidelines on page 6-3](#).

This section describes how to use a Four Slot Ethernet cradle ([Figure 5-2](#)) with the wearable terminal. For Ethernet communication setup procedures refer to the *WT41N0 Integrator Guide*.

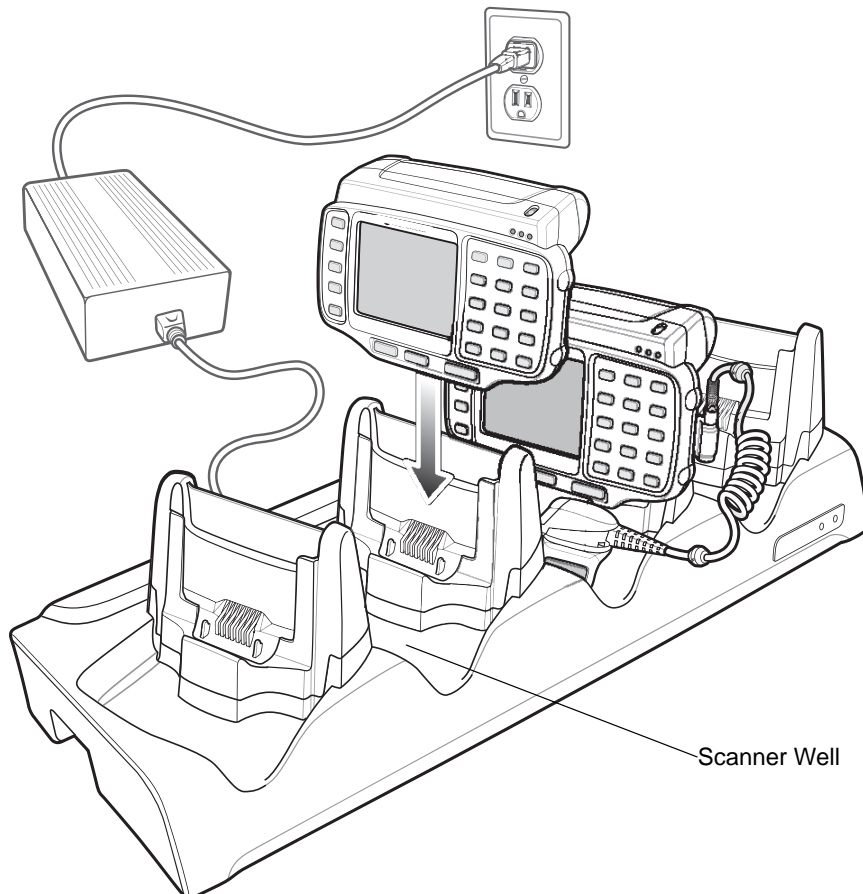

**Figure 5-2** Four Slot Ethernet Cradle

The Four Slot Ethernet cradle:

- Connects up to four wearable terminals to an Ethernet network.
- Provide 5.4 VDC power for operating the wearable terminal and charging the battery.
- Simultaneously charges up to four wearable terminals (with batteries installed).

The user cannot ActiveSync using the Four Slot Ethernet cradle. To ActiveSync with a host computer use the Single Slot USB cradle.

### Battery Charging

The four slot Ethernet cradle can charge up to four wearable terminals simultaneously. To charge the wearable terminal:

1. Slide the wearable terminal into the wearable terminal slot.
2. The wearable terminal amber Charge Status LED indicates the wearable terminal battery charging status. The standard capacity battery usually charges in less than four hours and the extended capacity battery fully charges in less than eight hours. See [Table 5-2](#) for charging status indications.
3. When charging is complete, remove the wearable terminal from the cradle.

### LED Indicators (CRD4000-4000ER)

There are two LEDs on the front of the cradle. The green Speed LED lights to indicate that the transfer rate is 100 Mbps. When the LED is not lit the transfer rate is 10 Mbps. The yellow Link LED blinks to indicate activity, or stays lit to indicate that a link is established. When it is not lit it indicates that there is no link.

**Table 5-3** CRD4000-4000ER LED Indicators

Data Rate	Green Speed LED (Left)	Yellow Link LED (right)
100 Mbps	On	On/Blink
10 Mbps	Off	On/Blink

### LED Indicators (CRD4001-4000ER)

There are two green LEDs on the front of the cradle. These green LEDs light and blink to indicate the data transfer rate. When the LEDs are not lit the transfer rate is 10 Mbps.

**Table 5-4** CRD4001-4000ER LED Indicators

Data Rate	Left LED (Green)	Right LED (Green)
1 Gbps	On/Blink	Off
100 Mbps	Off	On/Blink
10 Mbps	Off	Off

## Four Slot Spare Battery Charger



**CAUTION** Ensure that you follow the guidelines for battery safety described in [Battery Safety Guidelines on page 6-3](#).

This section describes how to use the Four Slot Spare Battery Charger to charge up to four wearable terminal spare batteries.

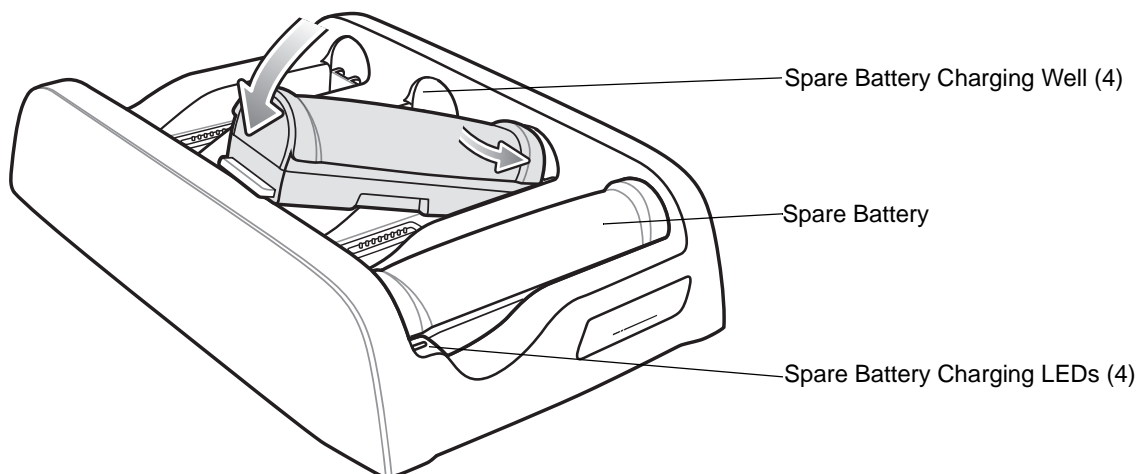

**Figure 5-3** Four Slot Spare Battery Charger

### Spare Battery Charging with the Four Slot Spare Battery Charger

Insert the battery into a spare battery charging slot and gently press down on the battery to ensure proper contact.

### Battery Charging Indicators

An amber LED is provided on each battery charging well. See [Table 5-5](#) for charging status indications. The standard capacity battery usually charges in less than four hours and the extended capacity battery fully charges in less than eight hours.

**Table 5-5** Spare Battery LED Charging Indicators

LED	Indication
Off	No spare battery in slot; spare battery not placed correctly; cradle is not powered.
Fast Blinking Amber	Charging error: <ul style="list-style-type: none"> <li>• Temperature is too low or too high.</li> <li>• Charging has gone on too long without completing (typically eight hours).</li> </ul>
Slow Blinking Amber	Spare battery is charging.
Solid Amber	Charging complete.

## RS409/RS419 Scanner

To connect the RS409 or RS419 scanner to the wearable terminal:

- ✓ **NOTE** There are two scanner configurations available. The short cable configuration connects the scanner to the wearable terminal mounted on the arm. The extended cable configuration connects the scanner to the WT41N0 mounted on the hip.

1. Remove the rubber plug from the wearable terminal interface connector.
2. Connect the scanner interface cable to the wearable terminal interface connector. If the wearable terminal is mounted on the arm, connect the cable to the interface connector closest to the wrist.

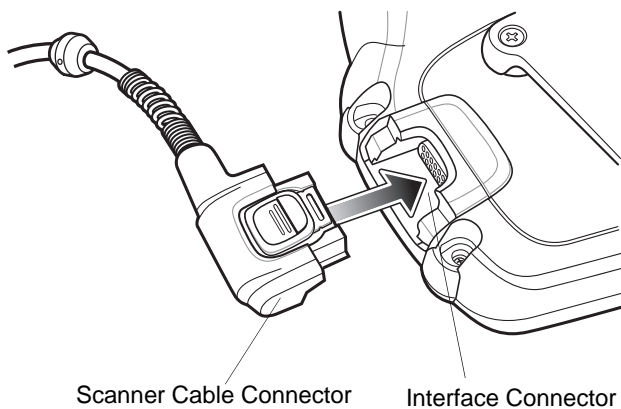

**Figure 5-4** Connecting Scanner to Wearable Terminal

3. If using the extended cable configuration, route the scanner cable up to the shoulder and down to the hand that the scanner mounts on. Attach two cable clips to clothing and secure cable to cable clip.

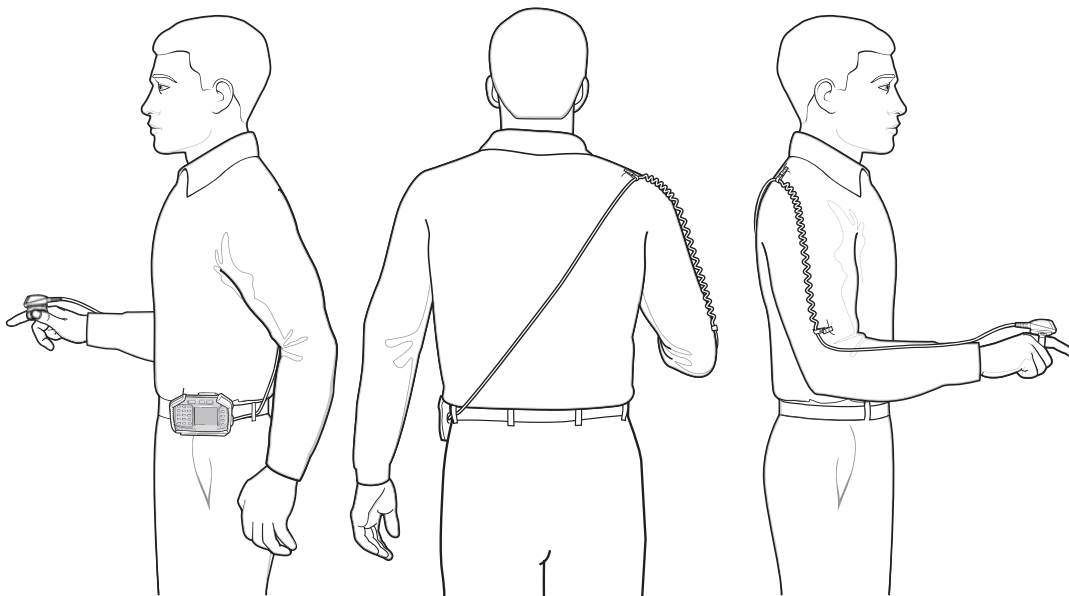

**Figure 5-5** Cable Clip Installation

4. Rotate the trigger assembly to the correct position for the hand that the scanner mounts to.

5. Slide the scanner onto the index finger with the scan trigger next to the thumb.

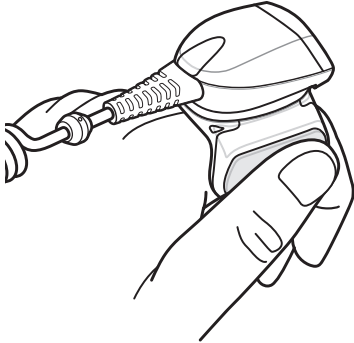

**Figure 5-6** *Place the Scanner on Index Finger*

6. Tighten the finger strap.

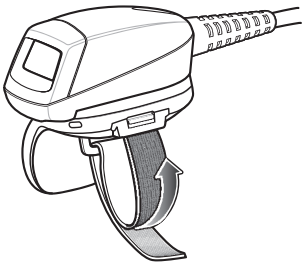

**Figure 5-7** *Tightening Straps*

7. If required, cut excess finger strap material.

After connecting the scanner, warm boot the wearable terminal. See [Resetting the Wearable Terminal on page 2-19](#) for information on performing a warm boot.

## RS309 Scanner

The RS309 connects to the wearable terminal and mounts on the back of either hand using the RS309 glove.

1. Remove the rubber plug from the wearable terminal interface connector.
2. Connect the RS309 trigger cable to the back of the RS309.

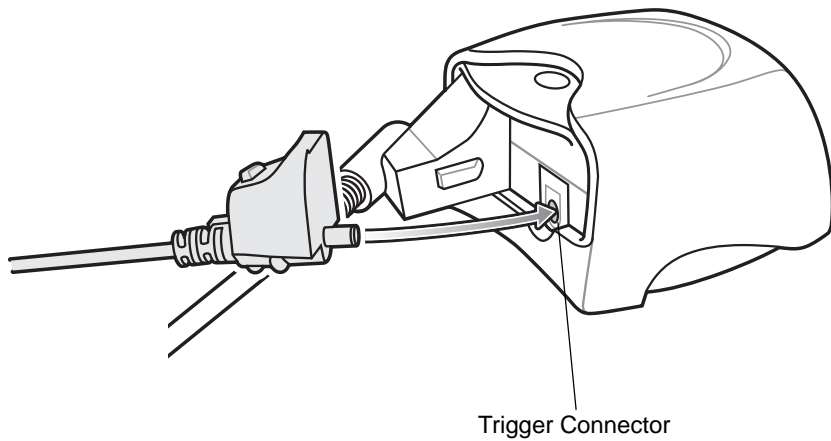

**Figure 5-8** Connecting Trigger Cable to RS309

3. Connect the end of the RS309 interface cable to the wearable terminal interface connector. If the wearable terminal is mounted on the arm, connect the cable to the interface connector closest to the wrist.
4. If the wearable terminal is mounted on the hip, route the interface cable up to the shoulder and down to the hand that the scanner mounts on. Attach two cable clips to clothing and secure cable to cable clip.

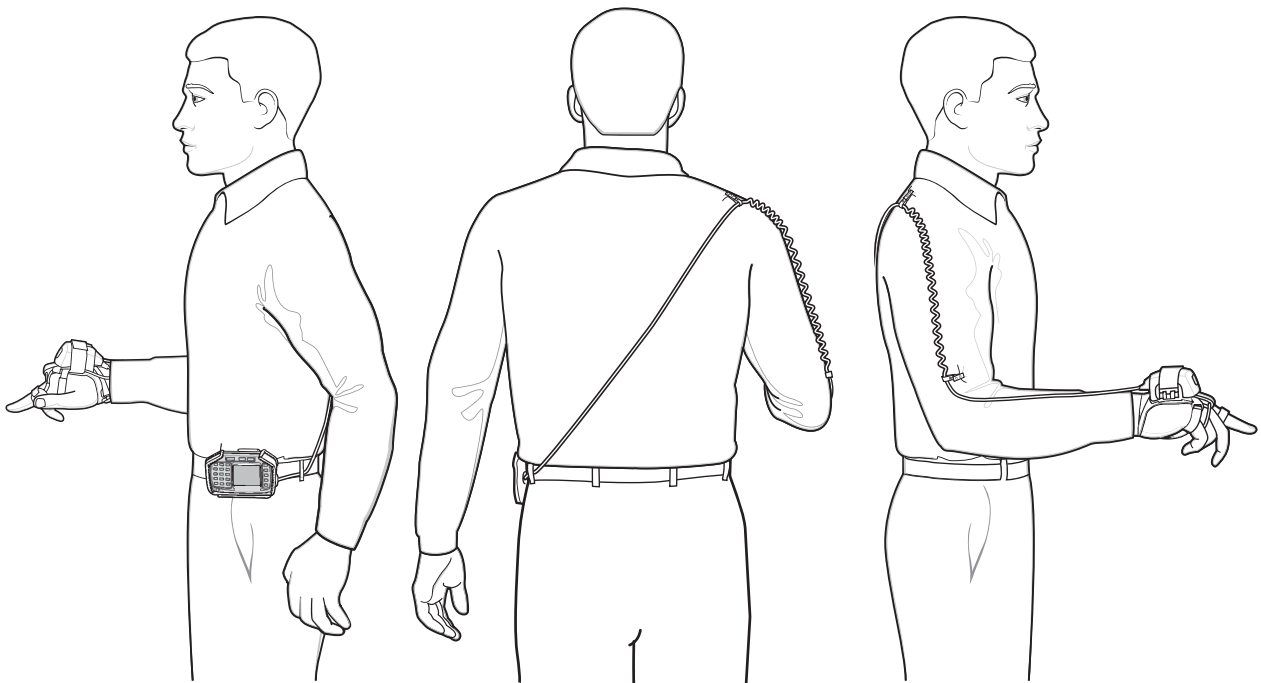

**Figure 5-9** Cable Clip Installation

5. Mount the RS309 on the RS309 glove. Refer to the RS309 Glove Installation Guide for information on mounting the RS309.
6. Route the trigger cable around the side of the RS309, next to the index finger.
7. Slide the trigger mount on the index finger, with the button positioned next to the thumb, and adjust the velcro strap.

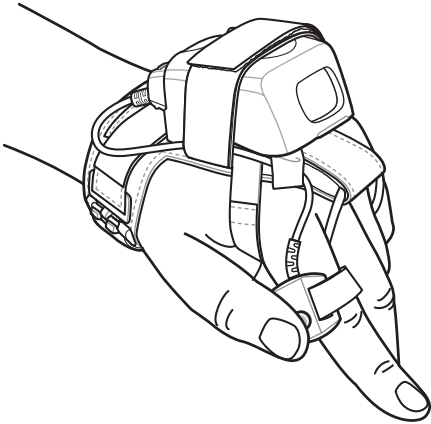

**Figure 5-10** *RS309 on Back of Hand*

After connecting the scanner, warm boot the wearable terminal. See [Resetting the Wearable Terminal on page 2-19](#) for information on performing a warm boot.

## RS507 Imager

Refer to the *RS507 Hands-free Imager Quick Reference Guide*, p/n 72-115987-xx and the *RS507 Hands-free Imager Product Reference Guide*, p/n 72E-120802-xx for detailed information.

## RS5000 Imager

- ✓ **NOTE** For optimal performance of the RS5000 ring scanner, it is recommended to update the WT41N0 to OS version 04.57.05 or later.

To connect the RS5000 imager to the wearable terminal:

1. Connect the imager interface cable to the wearable terminal interface connector. If the wearable terminal is mounted on the arm, connect the cable to the interface connector closest to the wrist.

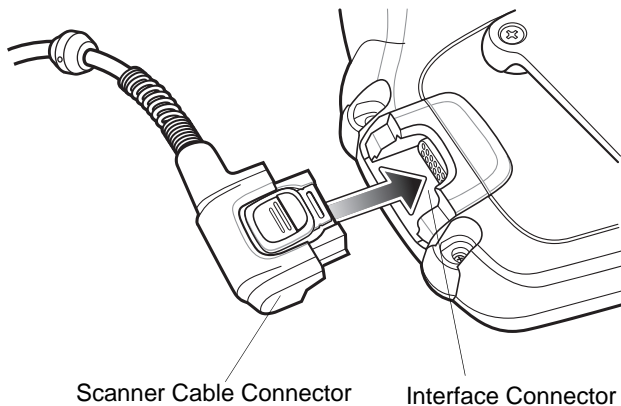

**Figure 5-11** Connecting Imager to Wearable Terminal

2. Rotate the trigger assembly to the correct position for the hand that the imager mounts to.
3. Slide the imager onto the index finger with the scan trigger next to the thumb.

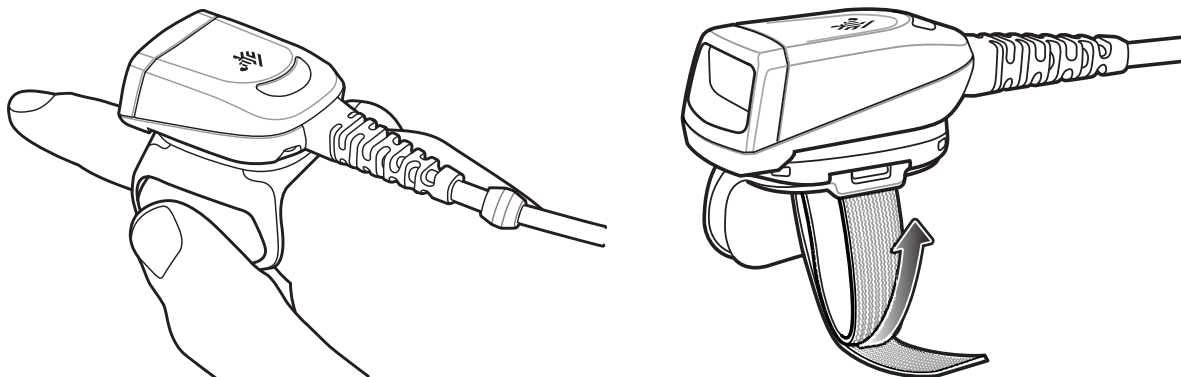
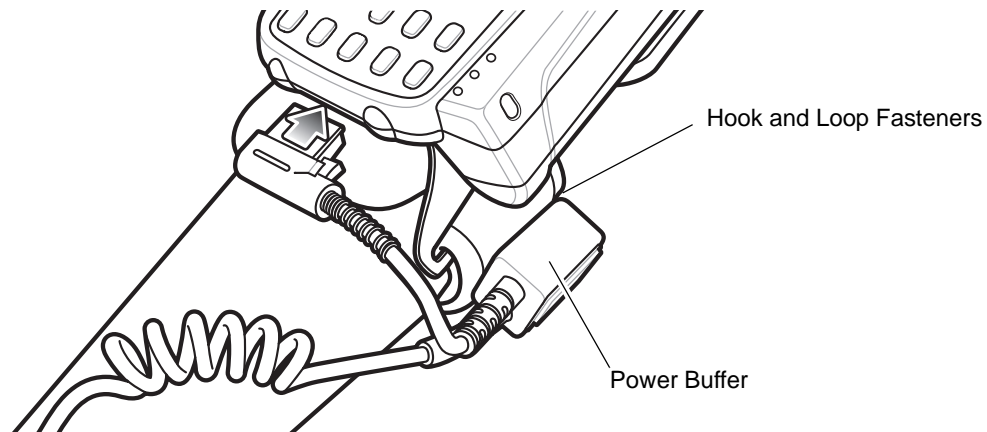

**Figure 5-12** Wearing the RS5000

4. Tighten the finger strap.
5. If required, cut excess finger strap material.



6. For the WT41N0, attach the power buffer to the wrist mount using the hook and loop fasteners.



**Figure 6** Attaching Power Buffer

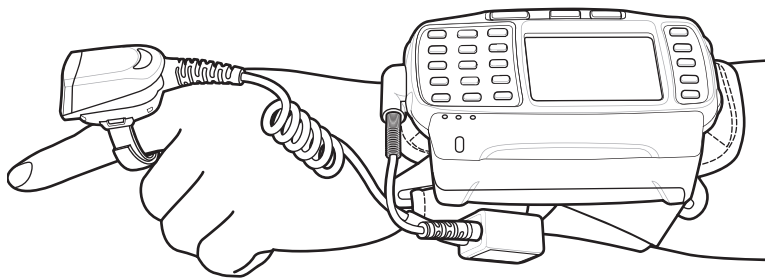

**Figure 7** Wearing the RS5000

7. Warm boot the wearable terminal. See [Resetting the Wearable Terminal on page 2-19](#) for information on performing a warm boot.

- ✓ **NOTE** The RS5000 uses the power buffer in the cable to maintain a power supply during heavy usage. When the unit has not been powered on for an extended period of time, there may be a minute or more of delay before the RS5000 is functional.

## Freezer Pouch

- ✓ **NOTE** Wearable computers with standard capacity batteries must use the Standard Capacity Battery Freezer Pouch while wearable computers with extended capacity batteries must use the Extended Capacity Battery Freezer Pouch. See [Table 5-1 on page 5-1](#) for more information.



- CAUTION** Do not use the wearable terminal with touch screen in the freezer pouch or in environments that are below -20°C (-4°F).

The freezer pouch allows the user to use the wearable terminal in a freezer environment on the hip or wrist for use in voice picking applications. An RS309, RS409 or RS419 scanner with an extended cable is required when mounting the freezer pouch on the hip mount, if scanning is also part of the application.

In order to keep the wearable terminal at a safe operating temperature in a meat or ice cream freezer, the freezer pouch insulates the wearable terminal to keep the heat generated by the wearable terminal within the pouch. The pouch is not heated. There are no batteries to worry about or electronics within the pouch.

The freezer pouch can be either hip-mounted or wrist-mounted. For hip-mounting, there is a belt loop on its back for attached a belt (sold separately). For wrist-mounting, customers can buy either a set of standard-length or longer-length wrist straps and use them with the pouch. The longer-length wrist straps are recommended for wrist-mounting over coats. The freezer pouch has openings on each side for wearable scanners and headset adapters.

While the freezer pouch is designed to allow workers to use the wearable terminal in meat and ice cream freezers, there are some very important limitations to follow:

- Do not use in environments that are below  $-30^{\circ}\text{C}$  ( $-22^{\circ}\text{F}$ ).
- Do not allow the wearable terminal (with or without the freezer pouch) to remain in the suspend mode in environments below  $-20^{\circ}\text{C}$  ( $-4^{\circ}\text{F}$ ) for more than 10 minutes. This prevents the wearable terminal from cooling down to the ambient freezer temperature. The pouch maintains the wearable terminal at a sufficient temperature while it is in use, but lengthy periods of inactivity bring the wearable terminal below its operating temperature.
- Do not store wearable terminals in the meat or ice cream freezer. As explained above, this would allow the wearable terminals to chill to the ambient freezer temperature, which is below their operating temperature. Furthermore, if batteries were left in wearable terminals stored in the freezer, the batteries themselves could freeze, which could damage them. At the least, they would not function while frozen.
- Batteries cannot be charged below  $0^{\circ}\text{C}$  ( $32^{\circ}\text{F}$ ). Zebra cradles and battery chargers have an automatic shut-off to insure this.
- If using wearable scanners with the wearable terminal in the meat or ice cream freezer for a shift, remember that the RS309 freezer configuration is the correct scanner to choose, due to its lower operating temperature range and its desiccant pack to remove condensation.

Slide the wearable terminal into the freezer pouch.

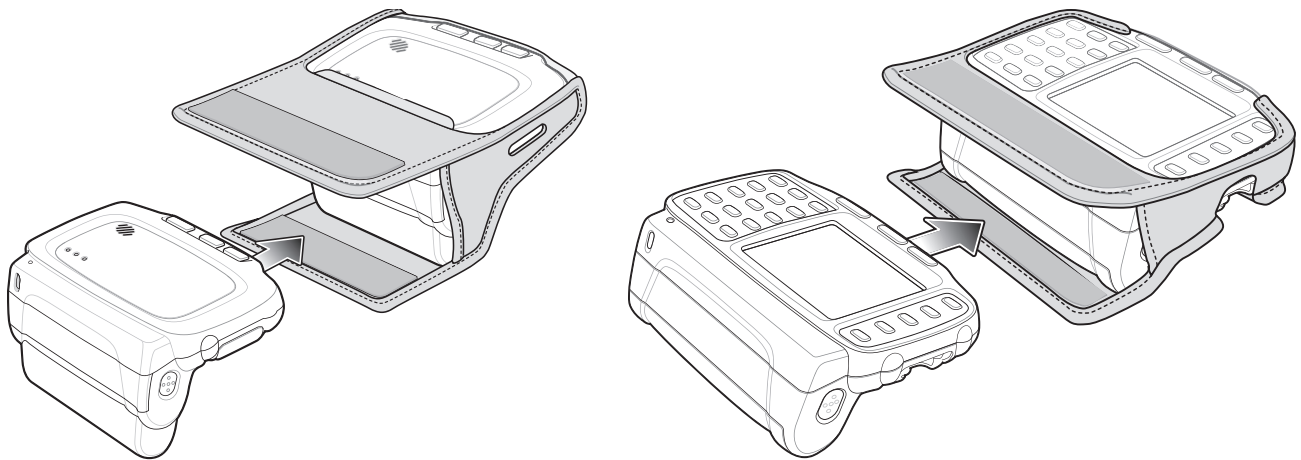

**Figure 5-1** *Insert Wearable Terminal into Freezer Pouch*

Close the front flap followed by the back flap.

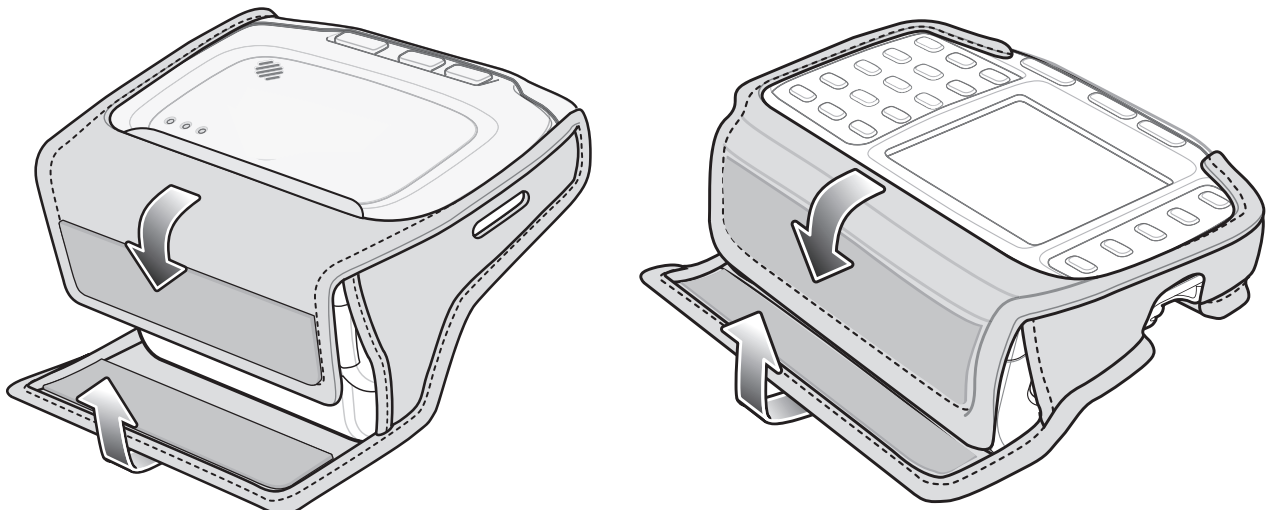
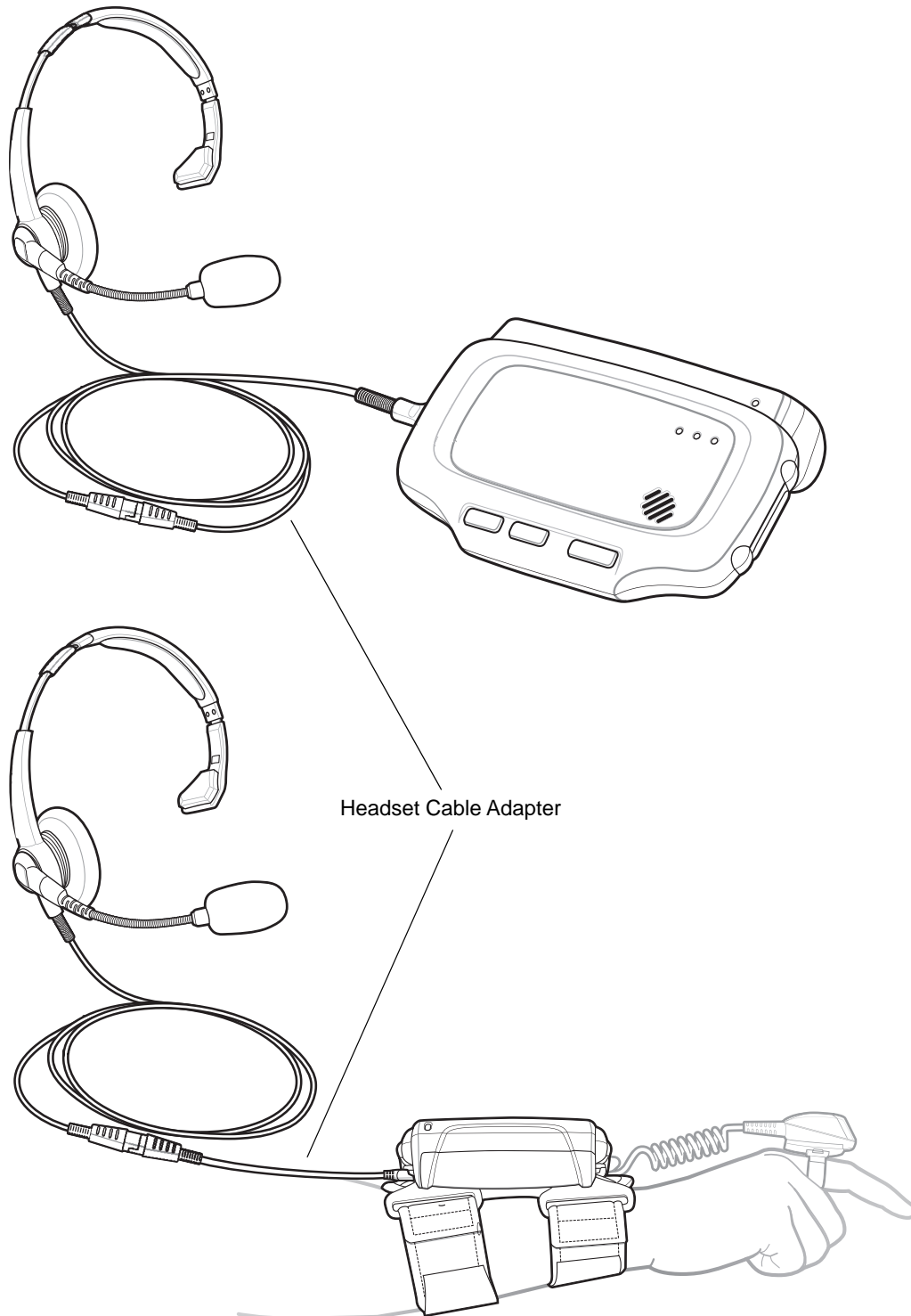

**Figure 5-2** Close Freezer Pouch Flaps

Slide a belt through the belt loop on the back of the freezer pouch. The wearable terminal can be mounted right-side up or up-side down depending upon user preference or application.

## Wired Headset

You can use a mono headset with a microphone for audio communication with an audio enabled application. The Headset Cable Adapter is required to connect a headset with the wearable terminal.

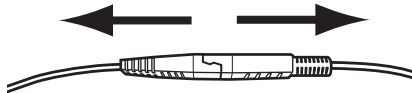

**Figure 5-3** Typical Headset Connected to Headset Adapter

The headset cable adapter connects the headset to the wearable terminal. Connect the headset connect end of the adapter to the headset connector. Plug the other end of the adapter to the wearable terminal interface connector.

✓ **NOTE** Not all headset plugs are compatible with the headset cable adapter.

⚠ **CAUTION** When disconnecting the headset from the headset adapter, pull the two connectors away from each. Do not bend connectors to disconnect.



**Figure 5-4** *Disconnecting Headset from Headset Adapter*

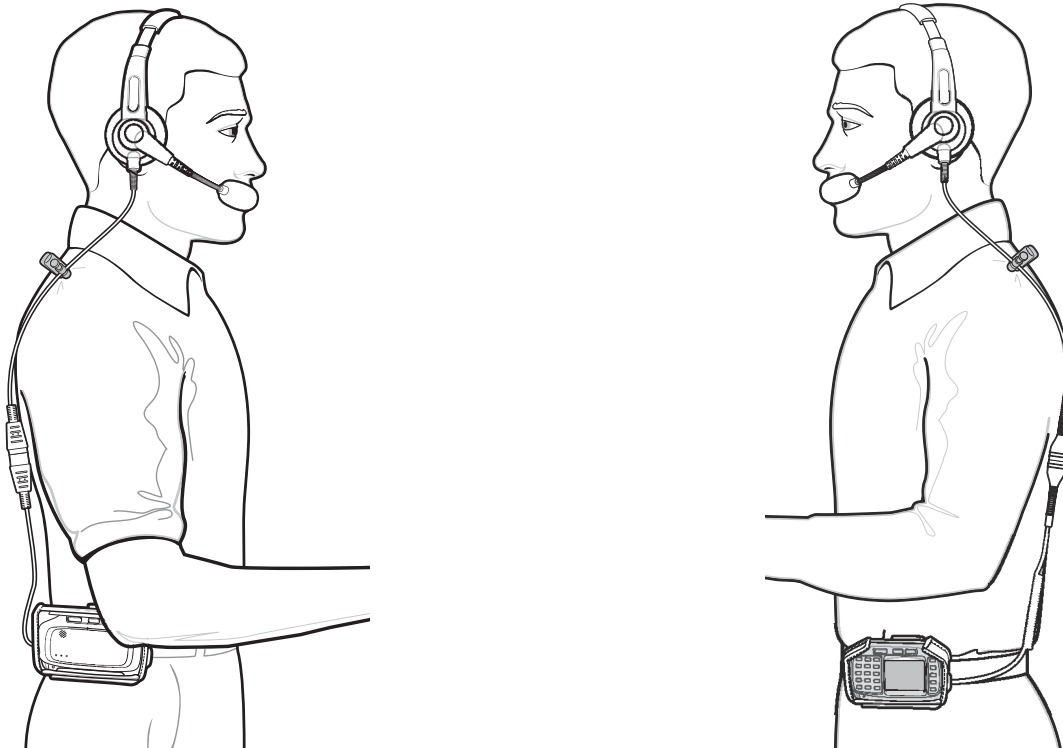

**Figure 5-5** *Headset Connected to wearable Terminal on Hip*

## Connector Shroud

- ✓ **NOTE** Only use with RS409 or RS419 extended cable configurations.

### Assembly

1. Remove cable from wearable terminal, if required.
2. Align the cable connector with the connector shroud bottom housing. Ensure that the disconnect button on the connector faces up.

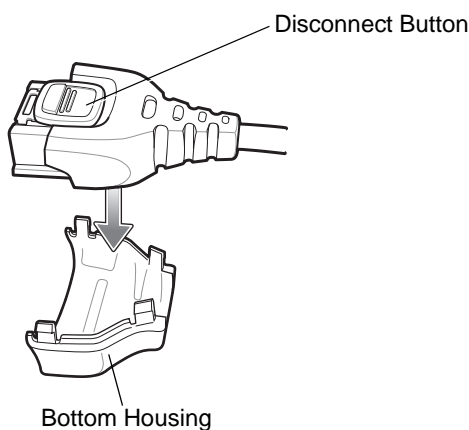

**Figure 5-6** *Installing Bottom Housing*

3. Place the cable connector into the shroud bottom housing as shown.

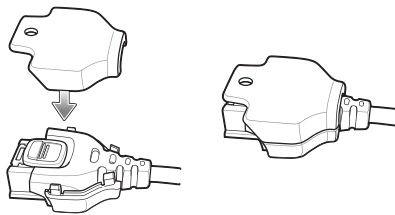

**Figure 5-7** *Installing Top Housing*

4. Press the top housing into the bottom housing. The housings will snap together.
5. Plug the cable connector into the wearable terminal connector.

### Disconnecting the Cable from the Wearable Terminal

- ✓ **NOTE** Follow the instructions below when disconnecting the cable connector and shroud from the wearable terminal. Once the shroud is installed on the connector, do not disassemble the shroud by prying it apart.

1. Turn the wearable terminal over to expose the top housing of the shroud.
2. Push the tip of a ball-point pen through the hole in the connector shroud top housing. The connector disengages from the wearable terminal.

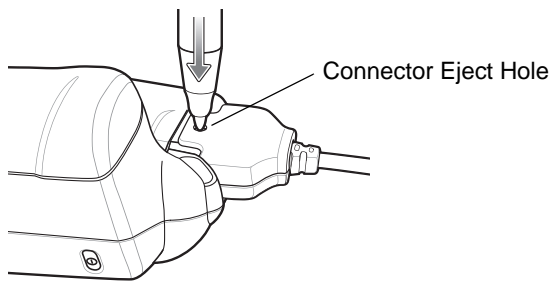

**Figure 5-8** *Disconnecting Connector with Shroud*





# CHAPTER 6 MAINTENANCE & TROUBLESHOOTING

---

## Introduction

This chapter includes instructions on cleaning and storing the wearable terminal, and provides troubleshooting solutions for potential problems during wearable terminal operation.

---

## Maintaining the Wearable Terminal

For trouble-free service, observe the following tips when using the wearable terminal:

- Do not scratch the touch screen of the wearable computer. When activating with the wearable computer touch screen, use finger tips. Never use a pen or pencil or other sharp object on the surface of the screen.

Zebra requires using a screen protector, p/n KT-114032-01R or KT-114032-02R.

- A screen protector is applied to the wearable computer touch screen. Zebra requires using this to minimize wear and tear. Screen protectors enhance the usability and durability of touch screen displays. Benefits include:
  - Protection from scratches and gouges
  - Durable touch surface with tactile feel
  - Abrasion and chemical resistance
  - Keeping the device's screen looking new
  - Quick and easy installation.
- Protect the wearable terminal with a touch screen from temperature extremes.
- Do not store or use the wearable terminal with a touch screen in any location that is extremely dusty, damp, or wet.
- Use a soft lens cloth to clean the wearable terminal display/touch panel.
- Periodically replace the rechargeable Li-ion battery to ensure maximum battery life and product performance. Battery life depends on individual usage patterns.
- The screen of the wearable terminal contains glass. Take care not to drop the wearable terminal or subject it to strong impact.

- Regularly replace all Velcro<sup>®</sup> straps on the wrist mount and wearable scanners, to ensure adequate adhesion of the Velcro.

## Wrist Mount Cleaning Instructions

It may be necessary to wash the wrist mount straps and replaceable pad when they become soiled.

Remove the straps and pad from the wrist mount. Hand wash in cold water with a mild detergent (such as Woolite<sup>®</sup>). Do not use bleach. Air dry. Do not use a dryer.

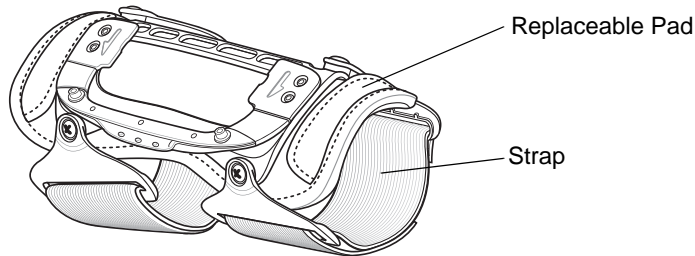

**Figure 6-1** Wrist Mount Soft Goods

## Arm Sleeve Cleaning Instructions

It may be necessary to wash the arm sleeve when it become soiled.

Hand wash in cold water with a mild detergent (such as Woolite<sup>®</sup>). Do not use bleach. Air dry. Do not use a dryer.

---

## Removing the Screen Protector

- ✓ **NOTE** Not using a screen protector on a wearable terminal with a touch screen can affect warranty coverage. To purchase replacement protectors, contact your local account manager or Zebra Technologies Corporation. These include screen protector installation instructions. Part number: KT-114032-01R or KT-114032-02R Screen Protector 3/pk.

A screen protector is applied to the wearable terminal with touch screen. Zebra recommends using this to minimize wear and tear. Screen protectors enhance the usability and durability of touch screen displays.

To remove the screen protector, lift the corner using a thin plastic card, such as a credit card, then carefully lift it off the display.

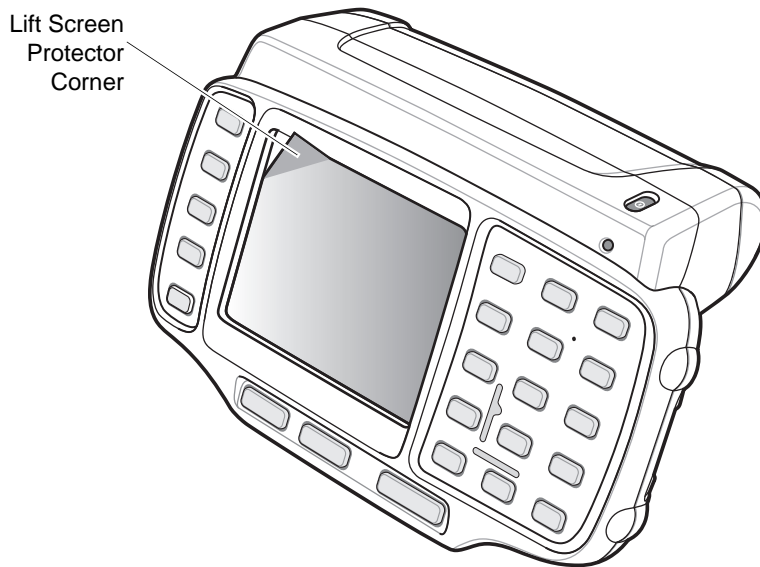

**Figure 6-2** *Removing the Screen Protector*



**CAUTION** Do not use a sharp object to remove the protector. Doing so can damage the touch screen.

---

## Battery Safety Guidelines

- The area in which the units are charged should be clear of debris and combustible materials or chemicals. Particular care should be taken where the device is charged in a non commercial environment.
- Improper battery use may result in a fire, explosion, or other hazard.
- To charge the mobile device battery, the battery and charger temperatures must be between 0 °C and +40 °C (+32 °F and +104 °F).
- Do not use incompatible batteries and chargers. Use of an incompatible battery or charger may present a risk of fire, explosion, leakage, or other hazard. If you have any questions about the compatibility of a battery or a charger, contact Zebra Global Customer support.
- Do not disassemble or open, crush, bend or deform, puncture, or shred.
- Severe impact from dropping any battery-operated device on a hard surface could cause the battery to overheat.
- Do not short circuit a battery or allow metallic or conductive objects to contact the battery terminals.
- Do not modify or remanufacture, attempt to insert foreign objects into the battery, immerse or expose to water or other liquids, or expose to fire, explosion, or other hazard.
- Do not leave or store the equipment in or near areas that might get very hot, such as in a parked vehicle or near a radiator or other heat source. Do not place battery into a microwave oven or dryer.
- Battery usage by children should be supervised.
- Please follow local regulations to promptly dispose of used re-chargeable batteries.
- Do not dispose of batteries in fire.

- Seek medical advice immediately if a battery has been swallowed.
- In the event of a battery leak, do not allow the liquid to come in contact with the skin or eyes. If contact has been made, wash the affected area with large amounts of water and seek medical advice.
- If you suspect damage to your equipment or battery, contact Zebra Global Customer support to arrange for inspection.

---

## Cleaning



**WARNING!** Avoid exposing this product to contact with hot oil or other flammable liquids. If such exposure occurs, unplug the device and clean the product immediately in accordance with these guidelines.



**CAUTION** Always wear eye protection.

Read warning label on compressed air and alcohol product before using.

If you have to use any other solution for medical reasons please contact Zebra for more information.

## Materials Required

- Alcohol wipes
- Soft lens cloth
- Cotton tipped applicators
- Isopropyl alcohol
- Can of compressed air with a tube.

## Cleaning the Wearable Terminal

### Housing

Using the alcohol wipes, wipe the housing including keys and in-between keys.

### Display

The display can be wiped down with the alcohol wipes, but care should be taken not to allow any pooling of liquid around the edges of the display. Immediately dried the display with a soft, non-abrasive cloth to prevent streaking. For WT41N0 with touch panel, only use a soft lens cloth to clean the touch panel overlay surface.

### Connectors

Clean all three connectors, two interface connectors on the sides of the wearable terminal and the cradle connector on the back.

1. Remove the main battery from mobile computer. See [Installing and Removing the Main Battery on page 1-7](#).
2. Remove connector rubber plugs, if required.

3. Dip the cotton portion of the cotton tipped applicator in isopropyl alcohol.
4. Rub the cotton portion of the cotton tipped applicator back-and-forth across each connector. Do not leave any cotton residue on the connector.
5. Repeat at least three times.
6. Use the cotton tipped applicator dipped in alcohol to remove any grease and dirt near the connector area.
7. Use a dry cotton tipped applicator and repeat steps 4 through 7.
8. Spray compressed air on the connector areas by pointing the tube/nozzle about ½ inch away from the surface.



**CAUTION** Do not point nozzle at yourself and others, ensure the nozzle or tube is away from your face.

9. Inspect the area for any grease or dirt, repeat if required.
10. Replace connector rubber plugs, if required.

## Cleaning the RS309, RS409, RS419, RS507 and RS5000

### Housing

Using the alcohol wipes, wipe the housing including keys and in-between keys.

### Scanner Exit Window

Wipe the scanner exit window periodically with a lens cloth or other material suitable for cleaning optical material such as eyeglasses.

### Connectors

1. Disconnect the scanner from mobile computer.
2. Dip the cotton portion of the cotton tipped applicator in isopropyl alcohol.
3. Rub the cotton portion of the cotton tipped applicator back-and-forth across the connector pins. Do not leave any cotton residue on the connector.
4. Repeat at least three times.
5. Use the cotton tipped applicator dipped in alcohol to remove any grease and dirt near the connector area.
6. Use a dry cotton tipped applicator and repeat steps 3 through 5.
7. Spray compressed air on the connector area by pointing the tube/nozzle about ½ inch away from the surface.



**CAUTION** Do not point nozzle at yourself and others, ensure the nozzle or tube is away from your face.

8. Inspect the area for any grease or dirt, repeat if required.

## Cleaning Cradle Connectors

To clean the connectors on a cradle:

1. Remove the DC power cable from the cradle.
2. Dip the cotton portion of the cotton tipped applicator in isopropyl alcohol.
3. Rub the cotton portion of the cotton tipped applicator along the pins of the connector. Slowly move the applicator back-and-forth from one side of the connector to the other. Do not let any cotton residue on the connector.
4. All sides of the connector should also be rubbed with the cotton tipped applicator.



**CAUTION** Do not point nozzle at yourself and others, ensure the nozzle or tube is away from your face.

5. Spray compressed air in the connector area by pointing the tube/nozzle about ½ inch away from the surface.
6. Ensure that there is no lint left by the cotton tipped applicator, remove lint if found.
7. If grease and other dirt can be found on other areas of the cradle, use lint free cloth and alcohol to remove.



**CAUTION** Allow at least 10 to 30 minutes (depending on ambient temperature and humidity) for the alcohol to air dry before applying power to cradle.

If the temperature is low and humidity is high, longer drying time is required. Warm temperature and dry humidity requires less drying time.

## Cleaning Frequency

The cleaning frequency is up to the customer's discretion due to the varied environments in which the mobile devices are used. They may be cleaned as frequently as required. However when used in dirty environments it may be advisable to periodically clean the ring scanners' exit windows to ensure optimum scanning performance.

## Troubleshooting

### Wearable Terminal

**Table 6-1** Troubleshooting the Wearable Terminal

Problem	Cause	Solution
Wearable terminal does not turn on.	Lithium-ion battery not charged.	Charge or replace the lithium-ion battery in the wearable terminal.
	Lithium-ion battery not installed properly.	Ensure battery is installed properly. See <a href="#">Installing and Removing the Main Battery on page 1-7</a> .
	System crash.	Perform a warm boot. If the wearable terminal still does not turn on, perform a cold boot. See <a href="#">Resetting the Wearable Terminal on page 2-19</a> .
Rechargeable lithium-ion battery did not charge.	Battery failed.	Replace battery. If the wearable terminal still does not operate, try a warm boot, then a cold boot. See <a href="#">Resetting the Wearable Terminal on page 2-19</a> .
	Wearable terminal removed from cradle while battery was charging.	Insert wearable terminal in cradle and begin charging. The standard capacity battery fully charges in less than four hours and the extended capacity battery fully charges in less than eight hours.
	Ambient temperature of the cradle is too warm or too cold.	Move the cradle to an area where the ambient temperature is between 0 °C and 40 °C (32 °F and 104 °F).
Cannot see characters on display.(not applicable to voice only configuration)	Wearable terminal not powered on.	Press the Power button.
	Screen protective is scratched or hazy.	Replace screen protector.
Display is hard to read. (not applicable to voice only configuration)	Screen protective is scratched or hazy.	Replace screen protector.

**Table 6-1** *Troubleshooting the Wearable Terminal (Continued)*

<b>Problem</b>	<b>Cause</b>	<b>Solution</b>
During data communication, no data was transmitted, or transmitted data was incomplete.	Wearable terminal removed from cradle or unplugged from host computer during communication.	Replace the wearable terminal in the cradle, or reattach the Synchronization cable and re-transmit.
	Incorrect cable configuration.	See the System Administrator.
	Communication software was incorrectly installed or configured.	Perform setup. Refer to the <i>WT41N0 Integrator Guide</i> for details. Ensure that Microsoft ActiveSync 4.5 or greater is installed on the host computer.
No sound is audible.	Volume setting is low or turned off.	Adjust volume. Change volume settings by selecting <b>Start &gt; Settings &gt; Control Panel &gt; Volume &amp; Sounds</b> icon > <b>Volume</b> tab. Move the slider to change the volume level or use volume control on voice application.
Wearable terminal turns itself off.	Wearable terminal is inactive.	The wearable terminal turns off after a period of inactivity. If the wearable terminal is running on battery power, this period can be set to 30 sec., 1, 2, 3, 4, 5 or 6 minutes. If the wearable terminal is running on external power, this period can be set to 1, 2, 3, 5, 10, 15 and 30 minutes. Check the power settings by selecting <b>Start &gt; Settings &gt; Control Panel &gt; Power</b> icon > <b>Advanced</b> tab. Change the setting if you need a longer delay before the automatic shutoff feature activates.
	Voice Only WT41N0 was set to suspend.	Return Voice Only WT41N0 suspend setting to factory default (disabled).
	Battery is depleted.	Replace or recharge the battery.
	Battery is not inserted properly.	Insert the battery properly (see <a href="#">Installing and Removing the Main Battery on page 1-7</a> ).
	The wearable terminal's battery is low and it powers down to protect memory content.	Replace or recharge the battery.



**Table 6-1** Troubleshooting the Wearable Terminal (Continued)

Problem	Cause	Solution
A message appears stating that the wearable terminal memory is full.(not applicable to voice only configuration)	Too many files stored on the wearable terminal.	Delete unused memos and records. You can save these records on the host computer.
	Too many applications installed on the wearable terminal.	If you have installed additional applications on the wearable terminal, remove them to recover memory. Select <b>Start &gt; Settings &gt; Control Panel &gt; Remove Programs</b> icon. Select the unused program and select <b>Remove</b> .
The wearable terminal does not accept scan input.	Scanning application is not loaded.	Verify that the unit is loaded with a scanning application. See the System Administrator.
	Unreadable bar code.	Ensure the symbol is not defaced.
	Distance between exit window and bar code is incorrect.	Ensure wearable terminal is within proper scanning range.
	Wearable terminal is not programmed for the bar code.	Ensure the wearable terminal is programmed to accept the type of bar code being scanned.
	Wearable terminal is not programmed to generate a beep.	If a beep on a good decode is expected and a beep is not heard, check that the application is set to generate a beep on good decode.
	Battery is low.	If the scanner stops emitting a laser beam when the trigger is pressed, check the battery level. When the battery is low, the scanner shuts off before the wearable terminal low battery condition notification. <b>Note:</b> If the scanner is still not reading symbols, contact the distributor or Zebra.
Wearable terminal goes into IPL mode after cold boot.	P1 or P2 key is held down during a cold boot.	Do not press the P1 or P2 key during a cold boot.
All three LEDs are lit solid.	Voice Only WT41N0 is in IPL mode.	Perform cold boot. See <a href="#">Resetting the Wearable Terminal on page 2-19</a> .
Wearable terminal cannot find any Bluetooth devices nearby.	Too far from other Bluetooth devices.	Move closer to the other Bluetooth device(s), within a range of 10 meters (32 feet).
	The Bluetooth device(s) nearby are not turned on.	Turn on the Bluetooth device(s) to find.
	The Bluetooth device(s) are not in discoverable mode.	Set the Bluetooth device(s) to discoverable mode. If needed, refer to the device's user documentation for help.

## Four Slot Ethernet Cradle

**Table 6-2** *Troubleshooting the Four Slot Ethernet Cradle*

Problem	Cause	Solution
Wearable terminal amber Charge Status LED does not light when wearable terminal inserted.	Cradle is not receiving power.	Ensure the power cable is connected securely to both the cradle and to AC power.
	Wearable terminal is not correctly seated.	Remove and re-insert the wearable terminal into the cradle, ensuring it is correctly seated.
Wearable terminal battery did not charge.	Wearable terminal was removed from cradle or cradle was unplugged from AC power too soon.	Ensure cradle is receiving power. Ensure the wearable terminal is seated correctly. If the wearable terminal battery is fully depleted, it can take up to four hours to fully recharge a standard capacity battery and it can take up to eight hours to fully recharge an extended capacity battery.
	Battery is faulty.	Verify that other batteries charge properly. If so, replace the faulty battery.
	The wearable terminal is not fully seated in the cradle.	Remove and re-insert the wearable terminal into the cradle, ensuring it is correctly seated.
	Ambient temperature of the cradle is too warm or too cold.	Move the cradle to an area where the ambient temperature is between 0 °C and 40 °C (32 °F and 104 °F).
During data communication, no data was transmitted, or transmitted data was incomplete.	Wearable terminal removed from cradle during communication.	Replace wearable terminal in cradle and retransmit.
	Incorrect cable configuration.	See the system administrator or refer to the <i>WT41N0 Integrator Guide</i> .
	Ethernet connection error.	See the system administrator. Probable Ethernet connection error.

## Four Slot Spare Battery Charger

**Table 6-3** *Troubleshooting The Four Slot Spare Battery Charger*

Symptom	Possible Cause	Solution
Batteries did not charge.	Battery was removed from the charger or charger was unplugged from AC power too soon.	Re-insert the battery in the charger or re-connect the charger's power supply.
	Battery is faulty.	Verify that other batteries charge properly. If so, replace the faulty battery.
	Battery contacts not connected to charger.	Verify that the battery is oriented properly and firmly seated in the battery well correctly with the contacts facing down. See <a href="#">Figure 5-3 on page 5-7</a> for proper battery orientation.
	Ambient temperature of the charger is too warm or too cold.	Move the charger to an area where the ambient temperature is between 0 °C and 40 °C (32 °F and 104 °F).

## Single Slot USB Cradle

**Table 6-4** Troubleshooting the Single Slot USB Cradle

Symptom	Possible Cause	Solution
Charge Status LEDs do not light when wearable terminal or spare battery is inserted.	Cradle is not receiving power.	Ensure the power cable is connected securely to both the cradle and to AC power.
	Wearable terminal is not seated firmly in the cradle.	Remove and re-insert the wearable terminal into the cradle, ensuring it is firmly seated.
	Spare battery is not seated firmly in the cradle.	Remove and re-insert the spare battery into the charging slot, ensuring it is firmly seated.
Wearable terminal battery is not charging.	Wearable terminal was removed from cradle or cradle was unplugged from AC power too soon.	Ensure cradle is receiving power. Ensure wearable terminal is seated correctly. Confirm main battery is charging. If a wearable terminal battery is fully depleted, it can take up to four hours to fully recharge a standard capacity battery and up to eight hours for an extended capacity battery (if the wearable terminal is off, and longer if the wearable terminal is operating). View battery status by selecting <b>Start &gt; Settings &gt; Control Panel &gt; Power</b> icon.
	Battery is faulty.	Verify that other batteries charge properly. If so, replace the faulty battery.
	The wearable terminal is not fully seated in the cradle.	Remove and re-insert the wearable terminal into the cradle, ensuring it is firmly seated.
	Ambient temperature of the cradle is too warm or too cold.	Move the cradle to an area where the ambient temperature is between 0°C and 40°C (32°F and 104°F).
Spare battery is not charging.	Battery inserted incorrectly.	Verify that the battery is oriented properly and firmly seated in the battery well correctly with the contacts facing down. See <a href="#">Figure 5-3 on page 5-7</a> for proper battery orientation.
	Battery is faulty.	Verify that other batteries charge properly. If so, replace the faulty battery.
	Ambient temperature of the cradle is too warm or too cold.	Move the cradle to an area where the ambient temperature is between 0 °C and 40 °C (32 °F and 104 °F).

**Table 6-4** Troubleshooting the Single Slot USB Cradle (Continued)

Symptom	Possible Cause	Solution
During data communications, no data was transmitted, or transmitted data was incomplete.	Wearable terminal removed from cradle during communications.	Replace wearable terminal in cradle and retransmit.
	Incorrect cable configuration.	See the System Administrator.
	Communications software is not installed or configured properly.	Perform setup as described in the <i>WT41N0 Integrator Guide</i> . Ensure that Microsoft ActiveSync 4.5 or greater is installed on the host computer.
Cannot ActiveSync with Host Computer	Wrong USB cable used.	Ensure that the cable has a USB A connector on one end and a USB mini B connector on the other end.
	Host computer not configured properly.	Ensure that ActiveSync on the host computer is set to allow USB connections.
	The wearable terminal is not fully seated in the cradle.	Remove and re-insert the wearable terminal into the cradle, ensuring it is firmly seated.



# APPENDIX A SPECIFICATIONS

## Technical Specifications

The following tables summarize the wearable terminal's intended operating environment and general technical hardware specifications.

### Wearable Terminal

The following table summarizes the wearable terminal's intended operating environment.

**Table A-1** *Technical Specifications*

Item	Description
<b>Physical and Environmental Characteristics</b>	
Dimensions	With standard battery: (14.2 cm L x 9.3 cm W x 2.6 cm H) 5.7 inches L x 3.7 inches W x 1.0 inch H With extended battery: (14.2 cm W x 10.7 cm H x 2.6 cm D) 5.7 inches L x 4.2 inches W x 1.0 inch H
Weight	With standard battery: (320 g) 11.3 oz. With extended battery: (370 g) 13.0 oz.
Keyboard	WT41N0: Alphanumeric Keypad Voice Only WT41N0: Three programmable function keys
Display	WT41N0: Color 2.8 inch QVGA non-touch or touch screens Voice Only WT41N0: None
Main Battery	Removable, rechargeable 3.7 VDC Lithium Ion battery. Standard capacity: 2400 mAh (minimum) Extended capacity: 4800 mAh (minimum)
Backup Battery	Two NiMH batteries (rechargeable) 15 mAh 2.4 VDC (not user accessible)
<b>Performance Characteristics</b>	
CPU	Dual-core OMAP 4 processor at 1 GHz

**Table A-1** Technical Specifications (Continued)

Item	Description
Operating System	Microsoft Windows Embedded Compact CE 7.0
Memory	2 GB Flash/512 MB RAM
Application Development	PSDK, DCP and EMDK
Data Capture Options	RS309 scanner RS409 scanner RS419 scanner RS507 Hands-free imager RS5000 imager
<b>User Environment</b>	
Operating Temperature	(-20 °C to 50 °C) -4 °F to 122°F (-30 °C to 50 °C) -22 °F to 122°F (with freezer pouch)
Storage Temperature	(-40 °C to 70 °C) -40 °F to 158 °F
Battery Charging Temperature	(0 °C to +40 °C) 32 °F to 104 °F ambient temperature range.
Humidity	5% to 95% non condensing
Drop Specification	Multiple 4 ft.(1.2 m) drops to concrete across operating temperature range
Tumble	500 half-meter tumbles at room temperature (1,000 drops)
Environmental Sealing	IP54 Category 2
ESD	± 15k VDC air discharge ± 8k VDC direct discharge ± 8k VDC indirect discharge
<b>WLAN Wireless Data Communications</b>	
WLAN radio	802.11a/b/g/n
Operating Channels	Channel 8 - 169 (5040 - 5845 MHz) (4920 - 4980 MHz) Japan only Channel 1 - 13 (2412 - 2472 MHz) Channel 14 (2484 MHz) Japan only Actual operating frequencies depend on regulatory rules and certification agency
Security	<b>Security Modes:</b> Legacy, WPA and WPA2 <b>Encryption:</b> WEP (40 or 128 bit), TKIP and AES <b>Authentication:</b> TLS, TTLS (MS-CHAP), TTLS (MS-CHAP v2), TTLS (CHAP), TTLS (MD5), TTLS (PAP), PEAP-TLS, PEAP (MSCHAP v2), PEAP (EAP-GTC), EAP-FAST-TLS, EAP-FAST (MS-CHAP v2), WEAP-FAST (EAP-GTC) and LEAP
Voice Communication	Runs voice recognition engines and text-to-speech engines for voice picking applications
Output Power	100 mW U.S. and International
Data Rate	802.11a: up to 54 MB per second 802.11b: up to 11 MB per second 802.11g: up to 54 MB per second 802.11n: up to 72.2 MB per second



**Table A-1** *Technical Specifications (Continued)*

Item	Description
Frequency Range	802.11a: 5 GHz; country-dependent 802.11b: 2.4 GHz; country-dependent 802.11g: 2.4 GHz; country-dependent 802.11n: 2.4 GHz; country-dependent
Antenna	Internal
<b>WPAN Wireless Data Communications</b>	
Bluetooth	Bluetooth Version 2.1 +EDR
<b>Peripherals and Accessories</b>	
Cradles	Single Slot USB Four Slot Ethernet
Printers	Supports extensive line of approved printers, cables and accessories
Charger	Four Slot Battery Charger
Other Accessories	Headset adapter, freezer pouch, hip mount and wrist mount.



# GLOSSARY

---

## A

**API.** An interface by means of which one software component communicates with or controls another. Usually used to refer to services provided by one software component to another, usually via software interrupts or function calls

**Application Programming Interface.** See **API**.

**ANSI Terminal.** A display terminal that follows commands in the ANSI standard terminal language. For example, it uses escape sequences to control the cursor, clear the screen and set colors. Communications programs support the ANSI terminal mode and often default to this terminal emulation for dial-up connections to online services.

**ASCII.** American Standard Code for Information Interchange. A 7 bit-plus-parity code representing 128 letters, numerals, punctuation marks and control characters. It is a standard data transmission code in the U.S.

---

## B

**Bar.** The dark element in a printed bar code symbol.

**Bar Code.** A pattern of variable-width bars and spaces which represents numeric or alphanumeric data in machine-readable form. The general format of a bar code symbol consists of a leading margin, start character, data or message character, check character (if any), stop character, and trailing margin. Within this framework, each recognizable symbology uses its own unique format. See **Symbology**.

**Bit.** Binary digit. One bit is the basic unit of binary information. Generally, eight consecutive bits compose one byte of data. The pattern of 0 and 1 values within the byte determines its meaning.

**Bits per Second (bps).** Bits transmitted or received.

**Bit.** Binary digit. One bit is the basic unit of binary information. Generally, eight consecutive bits compose one byte of data. The pattern of 0 and 1 values within the byte determines its meaning.

**bps.** See **Bits Per Second**.

**Byte.** On an addressable boundary, eight adjacent binary digits (0 and 1) combined in a pattern to represent a specific character or numeric value. Bits are numbered from the right, 0 through 7, with bit 0 the low-order bit. One byte in memory is used to store one ASCII character.

**boot or boot-up.** The process a computer goes through when it starts. During boot-up, the computer can run self-diagnostic tests and configure hardware and software.

---

## C

**CDRH.** Center for Devices and Radiological Health. A federal agency responsible for regulating laser product safety. This agency specifies various laser operation classes based on power output during operation.

**CDRH Class 1.** This is the lowest power CDRH laser classification. This class is considered intrinsically safe, even if all laser output were directed into the eye's pupil. There are no special operating procedures for this class.

**CDRH Class 2.** No additional software mechanisms are needed to conform to this limit. Laser operation in this class poses no danger for unintentional direct human exposure.

**Character.** A pattern of bars and spaces which either directly represents data or indicates a control function, such as a number, letter, punctuation mark, or communications control contained in a message.

**Codabar.** A discrete self-checking code with a character set consisting of digits 0 to 9 and six additional characters: (-\$/,+).

**Code 128.** A high density symbology which allows the controller to encode all 128 ASCII characters without adding extra symbol elements.

**Code 3 of 9 (Code 39).** A versatile and widely used alphanumeric bar code symbology with a set of 43 character types, including all uppercase letters, numerals from 0 to 9 and 7 special characters (space, minus (-), plus (+), period (.), dollar sign (\$), slash (/), and percent (%)). The code name is derived from the fact that 3 of 9 elements representing a character are wide, while the remaining 6 are narrow.

**Code 93.** An industrial symbology compatible with Code 39 but offering a full character ASCII set and a higher coding density than Code 39.

**Cold Boot.** A cold boot restarts the wearable terminal and erases all user stored records and entries.

**COM port.** Communication port; ports are identified by number, e.g., COM1, COM2.

**Cradle.** A cradle is used for charging the terminal battery and for communicating with a host computer, and provides a storage place for the terminal when not in use.

---

## D

**DCP.** See **Device Configuration Package**.

**Decode.** To recognize a bar code symbology (e.g., UPC/EAN) and then analyze the content of the specific bar code scanned.

**Decode Algorithm.** A decoding scheme that converts pulse widths into data representation of the letters or numbers encoded within a bar code symbol.

**Decryption.** Decryption is the decoding and unscrambling of received encrypted data. Also see, **Encryption** and **Key**.

**Depth of Field.** The range between minimum and maximum distances at which a scanner can read a symbol with a certain minimum element width.

**Device Configuration Package.** The Symbol Device Configuration Package provides the Product Reference Guide (PRG), flash partitions, Terminal Configuration Manager (TCM) and the associated TCM scripts. With this package hex images that represent flash partitions can be created and downloaded to the wearable terminal.

**Discrete 2 of 5.** A binary bar code symbology representing each character by a group of five bars, two of which are wide. The location of wide bars in the group determines which character is encoded; spaces are insignificant. Only numeric characters (0 to 9) and START/STOP characters may be encoded.

---

## E

**EAN.** European Article Number. This European/International version of the UPC provides its own coding format and symbology standards. Element dimensions are specified metrically. EAN is used primarily in retail.

**ENQ (RS-232).** ENQ software handshaking is also supported for the data sent to the host.

**ESD.** Electro-Static Discharge

---

## F

**Flash Disk.** An additional megabyte of non-volatile memory for storing application and configuration files.

**Flash Memory.** Flash memory is nonvolatile, semi-permanent storage that can be electronically erased in the circuit and reprogrammed. Wearable terminals use Flash memory to store the operating system (ROM-DOS), the terminal emulators, and the Citrix ICA Client for DOS.

**File Transfer Protocol (FTP).** A TCP/IP application protocol governing file transfer via network or telephone lines. See **TCP/IP**.

**FTP.** See **File Transfer Protocol**.

**Flash Memory.** Flash memory is responsible for storing the system firmware and is non-volatile. If the system power is interrupted the data is not be lost.

---

## H

**Hard Reset.** See **Cold Boot**.

**Hz.** Hertz; A unit of frequency equal to one cycle per second.

**Host Computer.** A computer that serves other terminals in a network, providing such services as computation, database access, supervisory programs and network control.

---

**I**

**IEC.** International Electrotechnical Commission. This international agency regulates laser safety by specifying various laser operation classes based on power output during operation.

**IEC (825) Class 1.** This is the lowest power IEC laser classification. Conformity is ensured through a software restriction of 120 seconds of laser operation within any 1000 second window and an automatic laser shutdown if the scanner's oscillating mirror fails.

**IEEE Address.** See **MAC Address**.

**Interleaved 2 of 5.** A binary bar code symbology representing character pairs in groups of five bars and five interleaved spaces. Interleaving provides for greater information density. The location of wide elements (bar/spaces) within each group determines which characters are encoded. This continuous code type uses no intercharacter spaces. Only numeric (0 to 9) and START/STOP characters may be encoded.

**IOCTL.** Input/Output Control.

**Interleaved Bar Code.** A bar code in which characters are paired together, using bars to represent the first character and the intervening spaces to represent the second.

**Interleaved 2 of 5.** A binary bar code symbology representing character pairs in groups of five bars and five interleaved spaces. Interleaving provides for greater information density. The location of wide elements (bar/spaces) within each group determines which characters are encoded. This continuous code type uses no intercharacter spaces. Only numeric (0 to 9) and START/STOP characters may be encoded.

**Internet Protocol Address.** See **IP**.

**I/O Ports.** interface The connection between two devices, defined by common physical characteristics, signal characteristics, and signal meanings. Types of interfaces include RS-232 and PCMCIA.

**Input/Output Ports.** I/O ports are primarily dedicated to passing information into or out of the terminal's memory. Wearable terminals include Serial and USB ports.

**IP.** Internet Protocol. The IP part of the TCP/IP communications protocol. IP implements the network layer (layer 3) of the protocol, which contains a network address and is used to route a message to a different network or subnetwork. IP accepts "packets" from the layer 4 transport protocol (TCP or UDP), adds its own header to it and delivers a "datagram" to the layer 2 data link protocol. It may also break the packet into fragments to support the maximum transmission unit (MTU) of the network.

**IP Address.** (Internet Protocol address) The address of a computer attached to an IP network. Every client and server station must have a unique IP address. A 32-bit address used by a computer on a IP network. Client workstations have either a permanent address or one that is dynamically assigned to them each session. IP addresses are written as four sets of numbers separated by periods; for example, 204.171.64.2.

**IPX/SPX.** Internet Package Exchange/Sequential Packet Exchange. A communications protocol for Novell. IPX is Novell's Layer 3 protocol, similar to XNS and IP, and used in NetWare networks. SPX is Novell's version of the Xerox SPP protocol.

**IS-95.** Interim Standard 95. The EIA/TIA standard that governs the operation of CDMA cellular service. Versions include IS-95A and IS-95B. See CDMA.

---

## K

**Key.** A key is the specific code used by the algorithm to encrypt or decrypt the data. Also see, **Encryption** and **Decrypting**.

---

## L

**laser scanner.** A type of bar code reader that uses a beam of laser light.

**LASER.** Light Amplification by Stimulated Emission of Radiation. The laser is an intense light source. Light from a laser is all the same frequency, unlike the output of an incandescent bulb. Laser light is typically coherent and has a high energy density.

**LCD.** See **Liquid Crystal Display**.

**LED Indicator.** A semiconductor diode (LED - Light Emitting Diode) used as an indicator, often in digital displays. The semiconductor uses applied voltage to produce light of a certain frequency determined by the semiconductor's particular chemical composition.

**Liquid Crystal Display (LCD).** A display that uses liquid crystal sealed between two glass plates. The crystals are excited by precise electrical charges, causing them to reflect light outside according to their bias. They use little electricity and react relatively quickly. They require external light to reflect their information to the user.

**Light Emitting Diode.** See **LED**.

---

## M

**MDN.** Mobile Directory Number. The directory listing telephone number that is dialed (generally using POTS) to reach a mobile unit. The MDN is usually associated with a MIN in a cellular telephone -- in the US and Canada, the MDN and MIN are the same value for voice cellular users. International roaming considerations often result in the MDN being different from the MIN.

**MIL.** 1 mil = 1 thousandth of an inch.

**MIN.** Mobile Identification Number. The unique account number associated with a cellular device. It is broadcast by the cellular device when accessing the cellular system.

---

## N

**Nominal.** The exact (or ideal) intended value for a specified parameter. Tolerances are specified as positive and negative deviations from this value.

---

## O

**Open Data-Link Interface (ODI).** Novell's driver specification for an interface between network hardware and higher-level protocols. It supports multiple protocols on a single NIC (Network Interface Controller). It is capable of understanding and translating any network information or request sent by any other ODI-compatible protocol into something a NetWare client can understand and process.

**Open System Authentication.** Open System authentication is a null authentication algorithm.

---

## P

**PAN .** Personal area network. Using Bluetooth wireless technology, PANs enable devices to communicate wirelessly. Generally, a wireless PAN consists of a dynamic group of less than 255 devices that communicate within about a 33-foot range. Only devices within this limited area typically participate in the network.

**Parameter.** A variable that can have different values assigned to it.

**PING.** (Packet Internet Groper) An Internet utility used to determine whether a particular IP address is online. It is used to test and debug a network by sending out a packet and waiting for a response.

**Print Contrast Signal (PCS).** Measurement of the contrast (brightness difference) between the bars and spaces of a symbol. A minimum PCS value is needed for a bar code symbol to be scannable.  $PCS = (RL - RD) / RL$ , where RL is the reflectance factor of the background and RD the reflectance factor of the dark bars.

---

## Q

**QWERTY.** A standard keyboard commonly used on North American and some European PC keyboards. "QWERTY" refers to the arrangement of keys on the left side of the third row of keys.

---

## R

**RAM.** Random Access Memory. Data in RAM can be accessed in random order, and quickly written and read.

**Resolution.** The narrowest element dimension which is distinguished by a particular reading device or printed with a particular device or method.

**RF.** Radio Frequency.

**ROM.** Read-Only Memory. Data stored in ROM cannot be changed or removed.

**Router.** A device that connects networks and supports the required protocols for packet filtering. Routers are typically used to extend the range of cabling and to organize the topology of a network into subnets. See **Subnet**.

**RS-232.** An Electronic Industries Association (EIA) standard that defines the connector, connector pins, and signals used to transfer data serially from one device to another.



---

## S

**Scan Area.** Area intended to contain a symbol.

**Scanner.** An electronic device used to scan bar code symbols and produce a digitized pattern that corresponds to the bars and spaces of the symbol. Its three main components are:

1. Light source (laser or photoelectric cell) - illuminates a bar code.
2. Photodetector - registers the difference in reflected light (more light reflected from spaces).
3. Signal conditioning circuit - transforms optical detector output into a digitized bar pattern.

**SDK.** Software Development Kit

**Secure Sockets Layer (SSL).** SSL is a commonly-used protocol for managing the security of a message transmission on the Internet. SSL uses a program layer located between the Internet's Hypertext Transfer Protocol (HTTP) and Transport Control Protocol (TCP) layers. SSL is included as part of both the Microsoft and Netscape browsers and most Web server products. Developed by Netscape, SSL also gained the support of Microsoft and other Internet client/server developers as well and became the de facto standard until evolving into Transport Layer Security. The "sockets" part of the term refers to the sockets method of passing data back and forth between a client and a server program in a network or between program layers in the same computer. SSL uses the public-and-private key encryption system from RSA, which also includes the use of a digital certificate.

**Shared Key.** Shared Key authentication is an algorithm where both the AP and the MU share an authentication key.

**SID.** System Identification code. An identifier issued by the FCC for each market. It is also broadcast by the cellular carriers to allow cellular devices to distinguish between the home and roaming service.

**SMDK.** Symbol Mobility Developer's Kit.

**Soft Reset.** See **Warm Boot**.

**Subnet.** A subset of nodes on a network that are serviced by the same router. See **Router**.

**Subnet Mask.** A 32-bit number used to separate the network and host sections of an IP address. A custom subnet mask subdivides an IP network into smaller subsections. The mask is a binary pattern that is matched up with the IP address to turn part of the host ID address field into a field for subnets. Default is often 255.255.255.0.

**Substrate.** A foundation material on which a substance or image is placed.

**Symbol.** A scannable unit that encodes data within the conventions of a certain symbology, usually including start/stop characters, quiet zones, data characters and check characters.

**Symbology.** The structural rules and conventions for representing data within a particular bar code type (e.g. UPC/EAN, Code 39, PDF417, etc.).

---

## T

**TCP/IP.** (Transmission Control Protocol/Internet Protocol) A communications protocol used to internetwork dissimilar systems. This standard is the protocol of the Internet and has become the global standard for communications. TCP provides transport functions, which ensures that the total amount of bytes sent is received correctly at the other end. UDP is an alternate transport that does not guarantee delivery. It is widely used for real-time voice and video transmissions where erroneous packets are not retransmitted. IP provides the routing mechanism. TCP/IP is a

routable protocol, which means that all messages contain not only the address of the destination station, but the address of a destination network. This allows TCP/IP messages to be sent to multiple networks within an organization or around the world, hence its use in the worldwide Internet. Every client and server in a TCP/IP network requires an IP address, which is either permanently assigned or dynamically assigned at startup.

**Telnet.** A terminal emulation protocol commonly used on the Internet and TCP/IP-based networks. It allows a user at a terminal or computer to log onto a remote device and run a program.

**Terminal.** See Wearable Terminal.

**Terminal Emulation.** A “terminal emulation” emulates a character-based mainframe session on a remote non-mainframe terminal, including all display features, commands and function keys. The WT41N0 Series supports Terminal Emulations in 3270, 5250 and VT220.

**TFTP.** (Trivial File Transfer Protocol) A version of the TCP/IP FTP (File Transfer Protocol) protocol that has no directory or password capability. It is the protocol used for upgrading firmware, downloading software and remote booting of diskless devices.

**Tolerance.** Allowable deviation from the nominal bar or space width.

**Transmission Control Protocol/Internet Protocol.** See **TCP/IP**.

**Transport Layer Security (TLS).** TLS is a protocol that ensures privacy between communicating applications and their users on the Internet. When a server and client communicate, TLS ensures that no third party may eavesdrop or tamper with any message. TLS is the successor to the Secure Sockets Layer (SSL).

**Trivial File Transfer Protocol.** See **TFTP**.

---

## U

**UPC.** Universal Product Code. A relatively complex numeric symbology. Each character consists of two bars and two spaces, each of which is any of four widths. The standard symbology for retail food packages in the United States.

**UDP.** User Datagram Protocol. A protocol within the IP protocol suite that is used in place of TCP when a reliable delivery is not required. For example, UDP is used for real-time audio and video traffic where lost packets are simply ignored, because there is no time to retransmit. If UDP is used and a reliable delivery is required, packet sequence checking and error notification must be written into the applications.

---

## U

**Visible Laser Diode (VLD).** A solid state device which produces visible laser light.

---

## W

**Warm Boot.** A warm boot restarts the wearable terminal by closing all running programs. All data that is not saved to flash memory is lost.

**Wearable Terminal.** In this text, wearable terminal refers to the WT41N0 that can be set up to communicate with a network, using wireless radio technology.



# INDEX

## Numerics

- 1-D bar codes ..... 3-1
- 2-D bar codes ..... 3-3

## A

- accessories
  - EMDK ..... 5-2
  - four slot cradles
    - battery charging ..... 5-5
  - four slot Ethernet cradle ..... 5-1, 5-5
  - four slot spare battery charger ..... 5-1
  - single slot USB cradle ..... 5-1, 5-3
    - LED indicators ..... 5-4, 5-7
  - spare battery charger ..... 5-7
    - power connection ..... 5-7

## B

- backlight ..... 2-12
- backup battery ..... 2-9
- bar codes
  - one dimensional ..... 3-1
  - two dimensional ..... 3-3
- battery
  - charging ..... 1-8
  - installing ..... 1-7
  - removing ..... 1-9
- battery charging
  - four slot cradles ..... 5-5
- battery charging temperature ..... A-2
- battery health ..... 2-21
- battery status ..... 2-10
- boot
  - cold ..... 1-14, 2-1, 2-19, 2-20
  - warm ..... 2-1, 2-19

- bullets ..... xii
- buttons
  - power ..... 2-1

## C

- characters, special ..... 2-5
- charging
  - spare batteries ..... 1-9
  - charging batteries ..... 1-8
  - charging spare batteries ..... 1-9
- cleaning ..... 6-1
- cold boot ..... 1-14, 2-1, 2-19, 2-20
- configurations ..... x
- conventions
  - notational ..... xi
- CPU ..... A-1
- cradles
  - four slot cradles
    - battery charging ..... 5-5
  - four slot Ethernet ..... 5-1, 5-5
  - single slot ..... 5-3
    - LED indicators ..... 5-4, 5-7
  - single slot USB ..... 5-1
  - spare battery charger ..... 5-7
    - power connection ..... 5-7
- current time ..... 2-9

## D

- data capture ..... x
  - adjusting the distance ..... 3-2
- imager operational modes
  - decode mode ..... 3-3
  - pick list mode ..... 3-3
- imaging ..... 3-3
- laser scanning ..... 3-1

- one dimensional bar codes . . . . . 3-1
- scan angle . . . . . 3-5
- scan range . . . . . 3-5
- scanning . . . . . 3-1, 3-3
- two dimensional bar codes . . . . . 3-3
- DataWedge . . . . . 2-10, 3-6
- date/time . . . . . 2-9, 2-12
- DCP for WT41N0c70 . . . . . xii
- Device Configuration Package . . . . . 5-2
- Device Configuration Package for WT41N0c70 . . . . . xii
- display . . . . . x, 2-12, A-1

**E**

- Enterprise Mobility Developer Kit for eVC4 . . . . . 5-2

**F**

- four slot cradles
  - battery charging . . . . . 5-5
- four slot Ethernet cradle . . . . . 5-1, 5-5
- four slot spare battery charger . . . . . 5-1

**G**

- getting started . . . . . 1-7

**H**

- hard reset . . . . . 1-14, 2-1, 2-19, 2-20
- health of battery . . . . . 2-21

**I**

- icon
  - battery status . . . . . 2-9
- icons
  - alpha mode . . . . . 2-10
  - ALT . . . . . 2-10
  - CTRL . . . . . 2-10
  - function . . . . . 2-10
  - shift . . . . . 2-10
- imager. See data capture, imaging
- imaging . . . . . 3-3
- information, service . . . . . xii
- installing main battery . . . . . 1-7

**K**

- key descriptions
  - alphanumeric . . . . . 2-4
- keyboard . . . . . A-1
- keypads . . . . . x
  - double-tap . . . . . 2-4

- types . . . . . 2-4
- voice only . . . . . 2-7

**L**

- laser scanning
  - See data capture . . . . . 3-1
- LED . . . . . 2-2
- LEDs
  - scan and decode . . . . . 3-2, 3-3
- lithium-ion battery . . . . . 1-3

**M**

- main battery
  - charging . . . . . 1-7, 1-8
  - installing . . . . . 1-7
- maintenance . . . . . 6-1
- memory . . . . . x, A-2
- MSP Agent . . . . . 2-11

**O**

- operating system . . . . . x, A-2

**P**

- parts of the wearable terminal . . . . . 1-1, 1-2, 1-4, 1-5, 1-6
- power . . . . . 2-2, 2-12
- power button . . . . . 2-1
- power LED . . . . . 2-2
- program menu . . . . . 2-11

**R**

- radios . . . . . x
- rapid deployment . . . . . 2-11
- regional settings . . . . . 2-12
- related documents . . . . . xii
- related software . . . . . xii
- removing main battery . . . . . 1-9
- reset
  - hard . . . . . 1-14, 2-1, 2-19, 2-20
  - soft . . . . . 2-1, 2-19
- resetting . . . . . 2-19

**S**

- scanning
  - bar codes . . . . . 3-1
  - imaging . . . . . 3-3
  - See data capture . . . . . 3-1
- screen
  - Symbol splash screen . . . . . 1-15

service information	xii
single slot USB cradle	5-1, 5-3
LED indicators	5-4, 5-7
soft reset	2-1, 2-19
spare batteries	
charging	1-9
spare battery	
charging	1-9
spare battery charger	5-7
power connection	5-7
special characters	2-5
specifications	A-1
starting the wearable terminal	1-7, 1-14
status	2-9
status icon	2-9, 2-10
suspend	1-9, 2-1
system information	2-13

## T

taskbar	2-9
troubleshooting	6-7
four slot spare battery charger	6-11
single slot serial/USB cradle	6-12
wearable terminal	6-7

## U

unpacking	1-3
USB port	2-13

## W

warm boot	2-1, 2-11, 2-19
wearable terminal	
power on	2-1
starting	1-14
weight	A-1
Windows Embedded CE 7.0 Compact	2-11
wireless status icon	2-10
WLAN 802.11a/b/g/n	x
WLAN status	2-10
WPAN Bluetooth	x
WT41N0	
dimensions	A-1
drop specification	A-2
humidity	A-2
operating temperature	A-2
storage temperature	A-2









Zebra Technologies Corporation  
Lincolnshire, IL U.S.A.  
<http://www.zebra.com>

Zebra and the Zebra head graphic are registered trademarks of ZIH Corp. The Symbol logo is a registered trademark of Symbol Technologies, Inc., a Zebra Technologies company.  
© 2016 Symbol Technologies, Inc.

