

SAC5070 8-Bay Battery Charger

Quick Reference Guide



Zebra reserves the right to make changes to any product to improve reliability, function, or design.

Zebra does not assume any product liability arising out of, or in connection with, the application or use of any product, circuit, or application described herein.

No license is granted, either expressly or by implication, estoppel, or otherwise under any patent right or patent, covering or relating to any combination, system, apparatus, machine, material, method, or process in which Zebra products might be used. An implied license exists only for equipment, circuits, and subsystems contained in Zebra products.

Zebra and the Zebra head graphic are registered trademarks of ZIH Corp. The Symbol logo is a registered trademark of Symbol Technologies, Inc., a Zebra Technologies company.

Zebra Technologies Corporation
Lincolnshire, IL U.S.A.

www.zebra.com/

Warranty

For the complete Zebra hardware product warranty statement, go to:

www.zebra.com/warranty.

Introduction

The SAC5070 8-Bay Battery Charger is an accessory for the RS507 Hands-free Imager and provides a quick way to recharge the Lithium-ion batteries that provide power for the RS507 Hands-Free Imager. One charger can hold up to eight batteries at a time.

The 8-Bay Battery Charger supports both standard and extended capacity batteries. The Charger may only be used indoors.

About this Guide

This guide provides basic information on the following topics:

- [Parts of the Charger on page 4](#)
- [Installation on page 5](#)
- [Inserting the Imager Battery in the Charger on page 7](#)
- [Battery Age Test on page 8](#)
- [Maintaining the Charger on page 9](#)
- [Troubleshooting on page 10](#)
- [Regulatory Information on page 10](#)
- [Wall Mount Template on page 17](#)

Unpacking the Charger

After opening the shipping box, inspect the contents. You should have received the following:

Model	Description	8-Bay Battery Charger	Power supply	AC Line Cord	Quick Start Guide
SAC5070-800CR	USA model	X	X	X	X
SAC5070-801CR	International model	X	X	*	X

* For AC line cord, contact the Zebra representative in your country.

Inspect the equipment for damage. If you are missing any equipment or if you find any damaged equipment, contact Zebra Support immediately.

Parts of the Charger

Charger Front

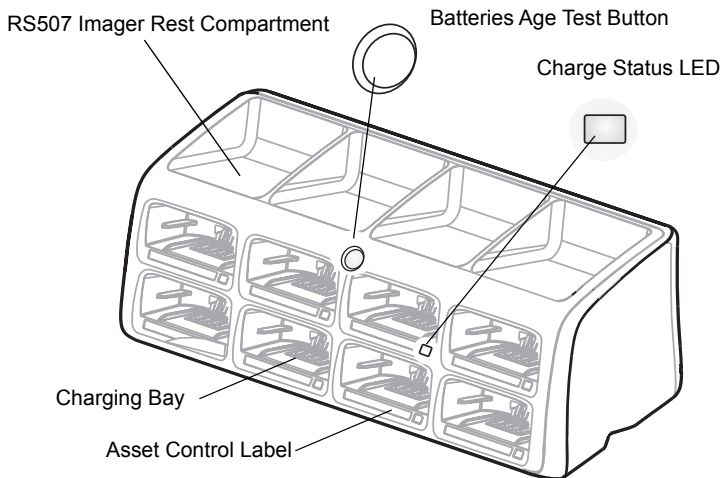

Charger Back

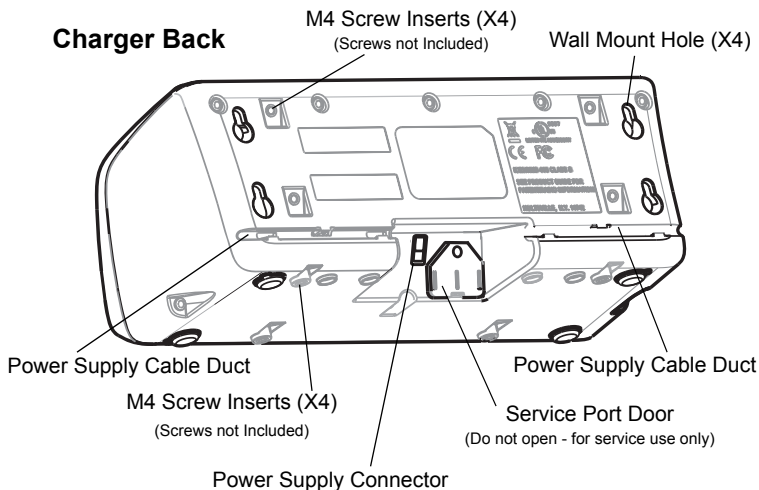

Installation

Tabletop / Shelf Set Up

To set the Charger on a tabletop or shelf:

1. Place the Charger and the Power Supply Unit on a tabletop or shelf.
NOTE When required, use the screw inserts at the back and base to secure the Charger to the tabletop or shelf surface (See [Figure on page 4](#)).
2. Connect the Power Supply Cable to the power connector on the back of the Charger.
3. Use the Power Supply Cable Duct, on the back of the Charger, to route the Power Supply Cable to the left or right side of the Charger.
4. Connect the AC plug of the AC Power Cord to a standard electrical outlet.

100-240 VAC, 50-60 Hz Outlet

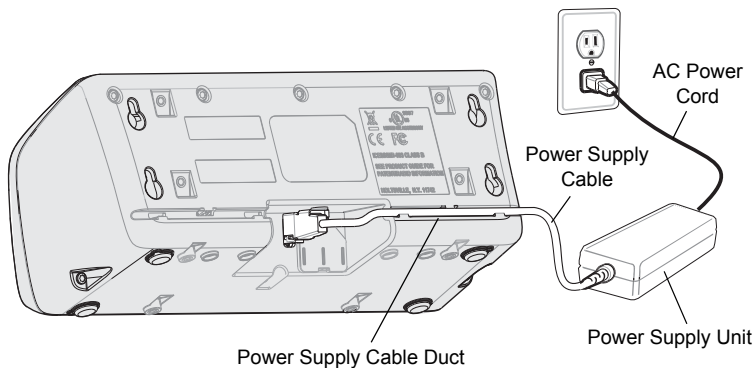

Wall Mount

WARNING! For safe mounting, it is essential to use wall anchors appropriate to the wall type (i.e. plaster, drywall, concrete, etc.). Mount to wood studs whenever possible.

To mount the Charger on a wall:

1. Use the wall mount template drawing on page 17 to mark the screw location on the wall.

2. Use four screws to mount the Charger to a wall. Ensure to use additional wall mounting hardware, as needed, for safe mounting according to the wall type.
3. Connect the power supply cable to the power connector on the back of the Charger (See [Figure on page 5](#)).
4. Use the Power Supply Cable Duct, on the back of the Charger, to route the Power Supply Cable to the left or right side of the Charger.
5. Place the Power Supply Unit on a shelf or tabletop.
6. Connect the AC plug of the AC Power Cord to a standard electrical outlet.

NOTE: Use [Wall Mount Template on page 17](#).

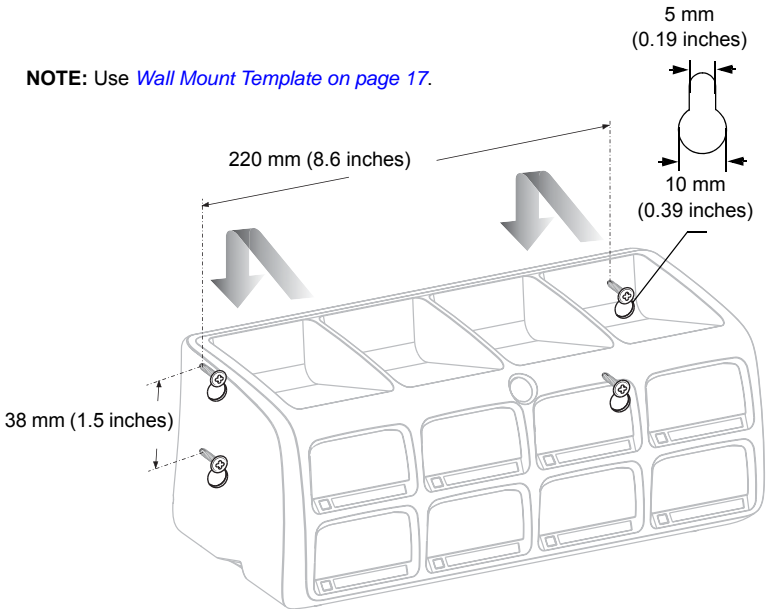

Inserting the Imager Battery in the Charger

The Charger supports both standard and extended capacity batteries.

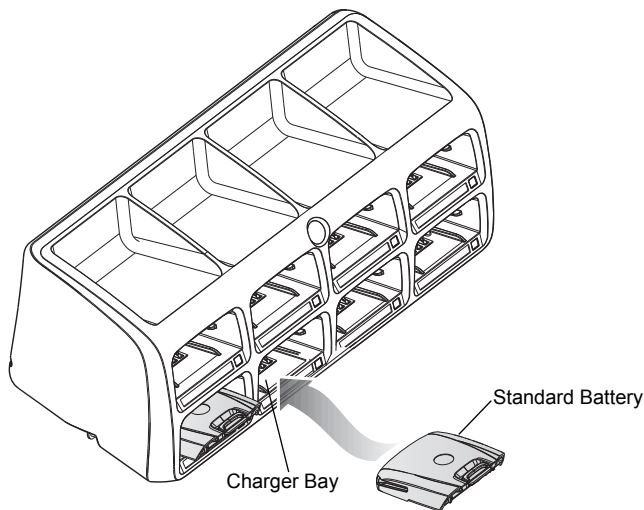

Charge the Battery

CAUTION Only Lithium-ion batteries that have been designed for use with the RS507 Hands-free Imager can be recharged by the Charger. Do not attempt to recharge other types of rechargeable batteries or any type of batteries. Doing so could destroy those batteries and damage the Charger.

NOTE Batteries should be charged within the +32°F (0°C) and +104°F (+40°C) ambient temperature range.

To charge the battery(s):

1. Insert the battery(s) into the 8-Bay Battery Charger so that the contacts of the battery are first to enter, facing down, gently. **DO NOT USE EXCESSIVE FORCE.**
2. The 8-Bay Battery Charger starts to charge automatically. On each bay, the flashing amber Charge Status LED (See [Figure on page 4](#)) indicates the charge status.

A full charge of a depleted battery takes up to four hours. The Charge Status LED lights solid amber when the battery is fully charged.

Battery Age Test

The battery age test checks the battery capacity when fully charged. A worn-out battery is considered to have less than 80% of its nominal capacity. The battery test is simultaneously performed for all batteries inserted into the charger. It is recommended to perform battery age testing once a month. The age test may take up to 16 hours.

NOTE A battery removed during test and re-inserted is excluded from the test but continues normal charging.

To test the battery(s):

1. Insert one or more batteries into Charging Bay(s).
2. Press and hold the Test Button for approximately 3 seconds until the Charge Status LED of each active bay flashes green.
3. Refer to the table below when the indication of the Charge Status LED changes.

Charge Status LED

The Charge Status LEDs show the charge status of each Charging Bay:

LED Indication	Status
Flashing amber	Charging in progress.
Solid amber	Charging is completed.
Flashing green	Battery age testing in progress.
Flashing red/green	Defective battery or error in charging; re-insert the battery into the bay.
Solid green	Battery age test and charge are completed. Battery is good
Solid red	Battery age test and charge are completed. Battery capacity is marginal.
Flashing red	Battery age test and charge are completed. Battery is worn out.

Maintaining the Charger

The Charger is well constructed and durable; however, it is a precision electronic device and must be treated as such.

Follow the procedures in this section to ensure reliable service.

Operating Conditions for the Charger

The Charger is designed to operate in environments that are normally free of dust, dirt, and moisture. It can be operated at temperatures between +32°F (0°C) and +104°F (+40°C).

Handling the Charger

- Do not attempt to open the Charger. No user-serviceable parts are inside.
- Charge only Lithium-ion batteries that have been designed for use in a RS507 Hands-free Imager. Do not attempt to recharge other types of rechargeable batteries or any type of primary batteries.
- Do not place objects other than RS507 Hands-free Imager batteries inside the Charger.
- Protect the Charger from excessive heat, cold, moisture, and harsh, dirty environments.
- Do not leave the Charger where moisture will condense on it.

Cleaning.



CAUTION Do not pour, spray, or spill any liquid on the Charger.

The gold plated battery contacts do not tarnish or oxidize. No maintenance should be needed. If the contacts need to be cleaned:

1. Remove power from the Charger.
2. Wet the tip of a cotton swab with isopropyl alcohol and squeeze the excess alcohol from the swab.
3. Wipe the metal contacts with the damp swab.

Troubleshooting

The Power LED does not light

- Make sure the Power plug of Power Supply Unit is plugged into a wall outlet and the connector on the end of the Power Supply Cable is snapped in the Charger's power connector.
- Plug the Power plug of Power Supply Unit into another outlet.
- Replace Power Supply Unit.
- Contact service representative.

The battery takes too long to recharge

- Ensure that room/battery temperatures are within charging range +32 °F to +104 °F (0 °C to +40 °C)
- Clean the contacts on the battery.
- Try another battery to make sure the Charger functions properly. (If the charge time is more than 4 hours the Charge Status LED flashes red/green).
- Contact service representative.

LED flashes Red/Green

- Remove and re-insert the battery into the charging bay.
- Check for dirt on battery charging contacts and/or charging bay contacts.
- Replace battery with a new one.
- Call service representative.

Regulatory Information

This guide applies to Model Number SAC5070.

All Zebra devices are designed to be compliant with rules and regulations in locations they are sold and will be labeled as required.

Local language translations are available at the following web site:

www.zebra.com/support.



CAUTION Any changes or modifications to Zebra equipment, not expressly approved by Zebra, could void the user's authority to operate the equipment.

For use only with Zebra approved and UL Listed mobile computers. Zebra approved and UL Listed accessories and/or Zebra approved and UL Listed/Recognized batteries.

Do NOT attempt to charge damp/wet mobile computers or batteries. All components must be dry before connecting to an external power source.

Charger Labeling

Charger ID Label

Regulatory Label

Regulatory Information

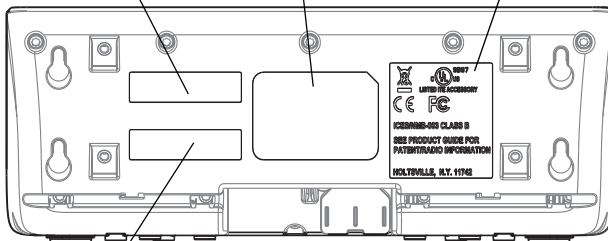

Country Stamp

Power Supply

Use only an approved power supply output rated at 12 VDC and minimum 4.17 A. The power supply shall be listed to UL/CSA 60950-1; and certified to IEC60950-1 and EN60950-1 with SELV outputs. Use of alternative power supply will invalidate any approval given to this device and may be dangerous.

Taiwan - Recycling



「廢電池請回收」

EPA (Environmental Protection Administration) requires dry battery producing or importing firms in accordance with Article 15 of the Waste Disposal Act are required to indicate the recycling marks on the batteries used in sales, giveaway or promotion. Contact a qualified Taiwanese recycler for proper battery disposal.

Battery Information

Zebra rechargeable batteries are designed and constructed to the highest standards within the industry.

However, there are limitations to how long a battery can operate or be stored before needing replacement. Many factors affect the actual life cycle of a battery, such as heat, cold, harsh environmental conditions and severe drops.

When batteries are stored over six (6) months, some irreversible deterioration in overall battery quality may occur. Store batteries at half of full charge in a dry, cool place, removed from the equipment to prevent loss of capacity, rusting of metallic parts and electrolyte leakage. When storing batteries for one year or longer, the charge level should be verified at least once a year and charged to half of full charge.

Replace the battery when a significant loss of run time is detected.

Standard warranty period for all Zebra batteries is 3 months, regardless if the battery was purchased separately or included as part of the mobile computer or bar code scanner. For more information on Zebra batteries, please visit: <http://www.zebra.com/batterybasics>

Battery Safety Guidelines

- The area in which the units are charged should be clear of debris and combustible materials or chemicals. Particular care should be taken where the device is charged in a non commercial environment.
- Follow battery usage, storage, and charging guidelines found in the user's guide.
- Improper battery use may result in a fire, explosion, or other hazard.
- To charge the mobile device battery, the battery and charger temperatures must be between +32 °F and +104 °F (0 °C and +40 °C)
- Do not use incompatible batteries and chargers. Use of an incompatible battery or charger may present a risk of fire, explosion, leakage, or other hazard. If you have any questions about the compatibility of a battery or a charger, contact Zebra support.
- Do not disassemble or open, crush, bend or deform, puncture, or shred.
- Severe impact from dropping any battery-operated device on a hard surface could cause the battery to overheat.
- Do not short circuit a battery or allow metallic or conductive objects to contact the battery terminals.

- Do not modify or remanufacture, attempt to insert foreign objects into the battery, immerse or expose to water or other liquids, or expose to fire, explosion, or other hazard.
- Do not leave or store the equipment in or near areas that might get very hot, such as in a parked vehicle or near a radiator or other heat source. Do not place battery into a microwave oven or dryer.
- Battery usage by children should be supervised.
- Please follow local regulations to promptly dispose of used re-chargeable batteries.
- Do not dispose of batteries in fire.
- Seek medical advice immediately if a battery has been swallowed.
- In the event of a battery leak, do not allow the liquid to come in contact with the skin or eyes. If contact has been made, wash the affected area with large amounts of water and seek medical advice.
- If you suspect damage to your equipment or battery, contact Zebra support to arrange for inspection.

Radio Frequency Interference Requirements-FCC



Note: This equipment has been tested and found to comply with the limits for a Class B digital device, pursuant to Part 15 of the FCC rules. These limits are designed to provide reasonable protection against harmful interference in a

residential installation. This equipment generates, uses and can radiate radio frequency energy and, if not installed and used in accordance with the instructions, may cause harmful interference to radio communications. However there is no guarantee that interference will not occur in a particular installation. If this equipment does cause harmful interference to radio or television reception, which can be determined by turning the equipment off and on, the user is encouraged to try to correct the interference by one or more of the following measures:

- Reorient or relocate the receiving antenna
- Increase the separation between the equipment and receiver
- Connect the equipment into an outlet on a circuit different from that to which the receiver is connected
- Consult the dealer or an experienced radio/TV technician for help.

Radio Frequency Interference Requirements - Canada

This Class B digital apparatus complies with Canadian ICES-003.

Cet appareil numérique de la classe B est conforme à la norme NMB-003 du Canada.

CE Marking and European Economic Area (EEA)

Statement of Compliance

Zebra hereby declares that this device is in compliance with all applicable Directives, 2014/30/EU, 2014/35/EU and 2011/65/EU. The full text of the EU Declaration of Conformity is available at the following internet address:
<http://www.zebra.com/doc>.

Japan (VCCI) - Voluntary Control Council for Interference

Class B ITE

この装置は、情報処理装置等電波障害自主規制協議会（VCCI）の基準に基づくクラスB情報技術装置です。この装置は、家庭環境で使用することを目的としていますが、この装置がラジオやテレビジョン受信機に近接して使用されると、受信障害を引き起こすことがあります。取扱説明書に従って正しい取り扱いをして下さい。

This is a Class B product based on the standard of the Voluntary Control Council for Interference from Information Technology Equipment (VCCI). If this is used near a radio or television receiver in a domestic environment, it may cause radio interference. Install and use the equipment according to the instruction manual.

Korea Warning Statement for Class B ITE

기종별	사용자 안내문
B급 기기	이 기기는 가정용으로 전자파 적합등록을 한 기기이오니 주거지역에서는 물론 모든 지역에서 사용할 수 있습니다.

Class	User's Guide
B class	As this equipment has obtained EMC registration for household use, it can be used in any area including residential areas.



Waste Electrical and Electronic Equipment (WEEE)

English: For EU Customers: All products at the end of their life must be returned to Zebra for recycling. For information on how to return product, please go to: www.zebra.com/weee.

Български: За клиенти от ЕС: След края на полезния им живот всички продукти трябва да се връщат на Zebra за рециклиране. За информация относно връщането на продукти, моля отидете на адрес: www.zebra.com/weee.

Čeština: Pro zákazníky z EU: Všechny produkty je nutné po skončení jejich životnosti vrátit společnosti Zebra k recyklaci. Informace o způsobu vrácení produktu najdete na webových stránkách: www.zebra.com/weee.

Dansk: Til kunder i EU: Alle produkter skal returneres til Zebra til recirkulering, når de er udtjent. Læs oplysningerne om returnering af produkter på: www.zebra.com/weee.

Deutsch: Für Kunden innerhalb der EU: Alle Produkte müssen am Ende ihrer Lebensdauer zum Recycling an Zebra zurückgesandt werden. Informationen zur Rücksendung von Produkten finden Sie unter: www.zebra.com/weee.

Eesti: EL klientidele: kõik tooted tuleb nende eluea lõppedes tagastada taaskasutamise eesmärgil Zebra'ile. Lisainformatsiooni saamiseks toote tagastamise kohta külastage palun aadressi: www.zebra.com/weee.

Español: Para clientes en la Unión Europea: todos los productos deberán entregarse a Zebra al final de su ciclo de vida para que sean reciclados. Si desea más información sobre cómo devolver un producto, visite: www.zebra.com/weee.

Ελληνικά: Για πελάτες στην Ε.Ε.: Όλα τα προϊόντα, στο τέλος της διάρκειας ζωής τους, πρέπει να επιστρέφονται στην Zebra για ανακύκλωση. Για περισσότερες πληροφορίες σχετικά με την επιστροφή ενός προϊόντος, επισκεφθείτε τη διεύθυνση: www.zebra.com/weee στο Διαδίκτυο.

Français: Clients de l'Union Européenne : Tous les produits en fin de cycle de vie doivent être retournés à Zebra pour recyclage. Pour de plus amples informations sur le retour de produits, consultez : www.zebra.com/weee.

Italiano: per i clienti dell'UE: tutti i prodotti che sono giunti al termine del rispettivo ciclo di vita devono essere restituiti a Zebra al fine di consentirne il riciclaggio. Per informazioni sulle modalità di restituzione, visitare il seguente sito Web: www.zebra.com/weee.

Lietuvių: ES vartotojams: visi gaminiai, pasibaigus jų eksploatacijos laikui, turi būti grąžinti utilizuoti į kompaniją „Zebra“. Daugiau informacijos, kaip grąžinti gaminį, rasite: www.zebra.com/weee.

Latviešu: ES klientiem: visi produkti pēc to kalpošanas mūža beigām ir jānogādā atpakaļ Zebra otrreizējai pārstrādei. Lai iegūtu informāciju par produktu nogādāšanu Zebra, lūdzu, skatiet: www.zebra.com/weee.

Magyar: Az EU-ban vásárlóknak: Minden tönkrement termékét a Zebra vállalathoz kell eljuttatni újrahasznosítás céljából. A termék visszajuttatásának módjával kapcsolatos tudnivalóért látogasson el a www.zebra.com/weee.

Malti: Għal klijenti fl-UE: il-prodotti kollha li jkunu waslu fl-aħħar tal-ħajja ta' l-użu tagħhom, iridu jiġu rritornati għand Zebra għar-riċiklaġġ. Għal aktar taġġrif dwar kif għandek tirritorna l-prodott, jekk jogħġbok żur: www.zebra.com/weee.

Nederlands: Voor klanten in de EU: alle producten dienen aan het einde van hun levensduur naar Zebra te worden teruggezonden voor recycling. Raadpleeg www.zebra.com/weee voor meer informatie over het terugzenden van producten.

Polski: Klienci z obszaru Unii Europejskiej: Produkty wycofane z eksploatacji należy zwrócić do firmy Zebra w celu ich utylizacji. Informacje na temat zwrotu produktów znajdują się na stronie internetowej www.zebra.com/weee.

Português: Para clientes da UE: todos os produtos no fim de vida devem ser devolvidos à Zebra para reciclagem. Para obter informações sobre como devolver o produto, visite: www.zebra.com/weee.

Românesc: Pentru clienții din UE: Toate produsele, la sfârșitul duratei lor de funcționare, trebuie returnate la Zebra pentru reciclare. Pentru informații despre returnarea produsului, accesați: www.zebra.com/weee.

Slovenski: Za kupce v EU: vsi izdelki se morajo po poteku življenjske dobe vrniti podjetju Zebra za reciklažo. Za informacije o vračilu izdelka obiščite: www.zebra.com/weee.

Slovenčina: Pre zákazníkov z krajín EU: Všetky výrobky musia byť po uplynutí doby ich životnosti vrátené spoločnosti Zebra na recykláciu. Bližšie informácie o vrátení výrobkov nájdete na: www.zebra.com/weee.

Suomi: Asiakkaat Euroopan unionin alueella: Kaikki tuotteet on palautettava kierrätettäväksi Zebra-yhtiöön, kun tuotetta ei enää käytetä. Lisätietoja tuotteen palauttamisesta on osoitteessa www.zebra.com/weee

Svenska: För kunder inom EU: Alla produkter som uppnått sin livslängd måste returneras till Zebra för återvinning. Information om hur du returnerar produkten finns på www.zebra.com/weee.

Hrvatski: Za kupce u Europskoj uniji: Svi se proizvodi po isteku vijeka trajanja moraju vratiti tvrtki Zebra na recikliranje. Informacije o načinu vraćanja proizvoda potražite na web-stranici: <http://www.zebra.com/weee>.

Mount Template

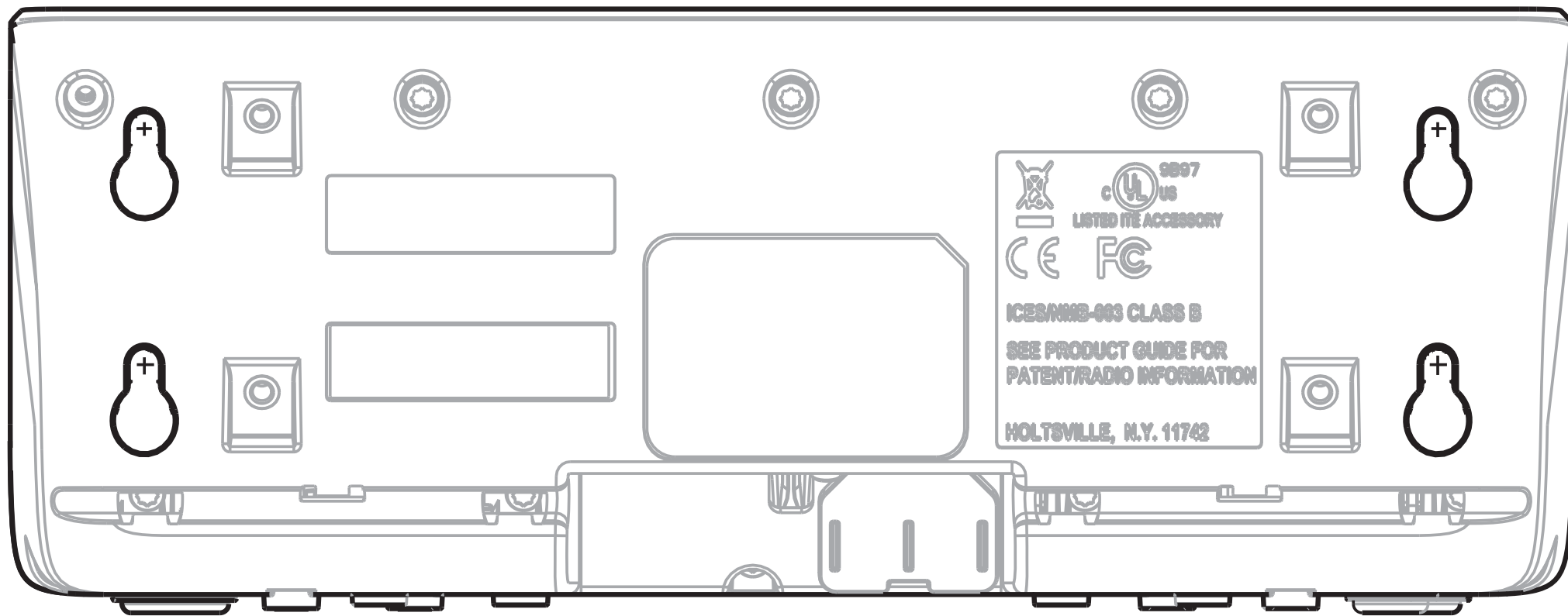

CMM Disclosure

部件名称 (Parts)	有害物质 					
	铅 (Pb)	汞 (Hg)	镉 (Cd)	六价铬 (Cr (VI))	多溴联苯 (PBB)	多溴二苯醚 (PBDE)
金属部件 (Metal Parts)	X	0	0	0	0	0
电路模块 (Circuit Modules)	X	0	0	0	0	0
电缆及电缆组件 (Cables and Cable Assemblies)	X	0	0	0	0	0
塑料和聚合物部件 (Plastic and Polymeric Parts)	X	0	0	0	0	0
光学和光学组件 (Optics and Optical Components)	0	0	0	0	0	0
电池 (Batteries)	X	0	0	0	0	0

本表格依据SJ/T 11364 的规定编制。

- 0: 表示该有害物质在该部件所有均质材料中的含量均在 GB/T 26572 规定的限量要求以下。
- X: 表示该有害物质至少在该部件的某一均质材料中的含量超出GB/T 26572 规定的限量要求。(企业可在此处, 根据实际情况对上表中打“×”的技术原因进行进一步说明。)

This table was created to comply with China RoHS requirements.

Service Information

If you have a problem using the equipment, contact your facility's Technical or Systems Support. If there is a problem with the equipment, they will contact the Zebra Support at:

www.zebra.com/support.

For the latest version of this guide go to:

www.zebra.com/support.



Zebra Technologies Corporation
Lincolnshire, IL U.S.A.
<http://www.zebra.com>

Zebra and the stylized Zebra head are trademarks of ZIH Corp., registered in many jurisdictions worldwide. All other trademarks are the property of their respective owners.

©2016 Symbol Technologies LLC, a subsidiary of Zebra Technologies Corporation. All rights reserved.



72-115989-04 Revision A - October 2016