

TC52

Touch Computer



Quick Start Guide



ZEBRA

Copyright

© 2018 ZIH Corp. and/or its affiliates. All rights reserved. ZEBRA and the stylized Zebra head are trademarks of ZIH Corp., registered in many jurisdictions worldwide. All other trademarks are the property of their respective owners.

COPYRIGHTS & TRADEMARKS: For complete copyright and trademark information, go to www.zebra.com/copyright.

WARRANTY: For complete warranty information, go to www.zebra.com/warranty.

END USER LICENSE AGREEMENT: For complete EULA information, go to www.zebra.com/eula.

Terms of Use

Proprietary Statement

This manual contains proprietary information of Zebra Technologies Corporation and its subsidiaries (“Zebra Technologies”). It is intended solely for the information and use of parties operating and maintaining the equipment described herein. Such proprietary information may not be used, reproduced, or disclosed to any other parties for any other purpose without the express, written permission of Zebra Technologies.

Product Improvements

Continuous improvement of products is a policy of Zebra Technologies. All specifications and designs are subject to change without notice.

Liability Disclaimer

Zebra Technologies takes steps to ensure that its published Engineering specifications and manuals are correct; however, errors do occur. Zebra Technologies reserves the right to correct any such errors and disclaims liability resulting therefrom.

Limitation of Liability

In no event shall Zebra Technologies or anyone else involved in the creation, production, or delivery of the accompanying product (including hardware and software) be liable for any damages whatsoever (including, without limitation, consequential damages including loss of business profits, business interruption, or loss of business information) arising out of the use of, the results of use of, or inability to use such product, even if Zebra Technologies has been advised of the possibility of such damages. Some jurisdictions do not allow the exclusion or limitation of incidental or consequential damages, so the above limitation or exclusion may not apply to you.

Provide Documentation Feedback

If you have comments, questions, or suggestions about this guide, send an email to EVM-Techdocs@zebra.com.

Features

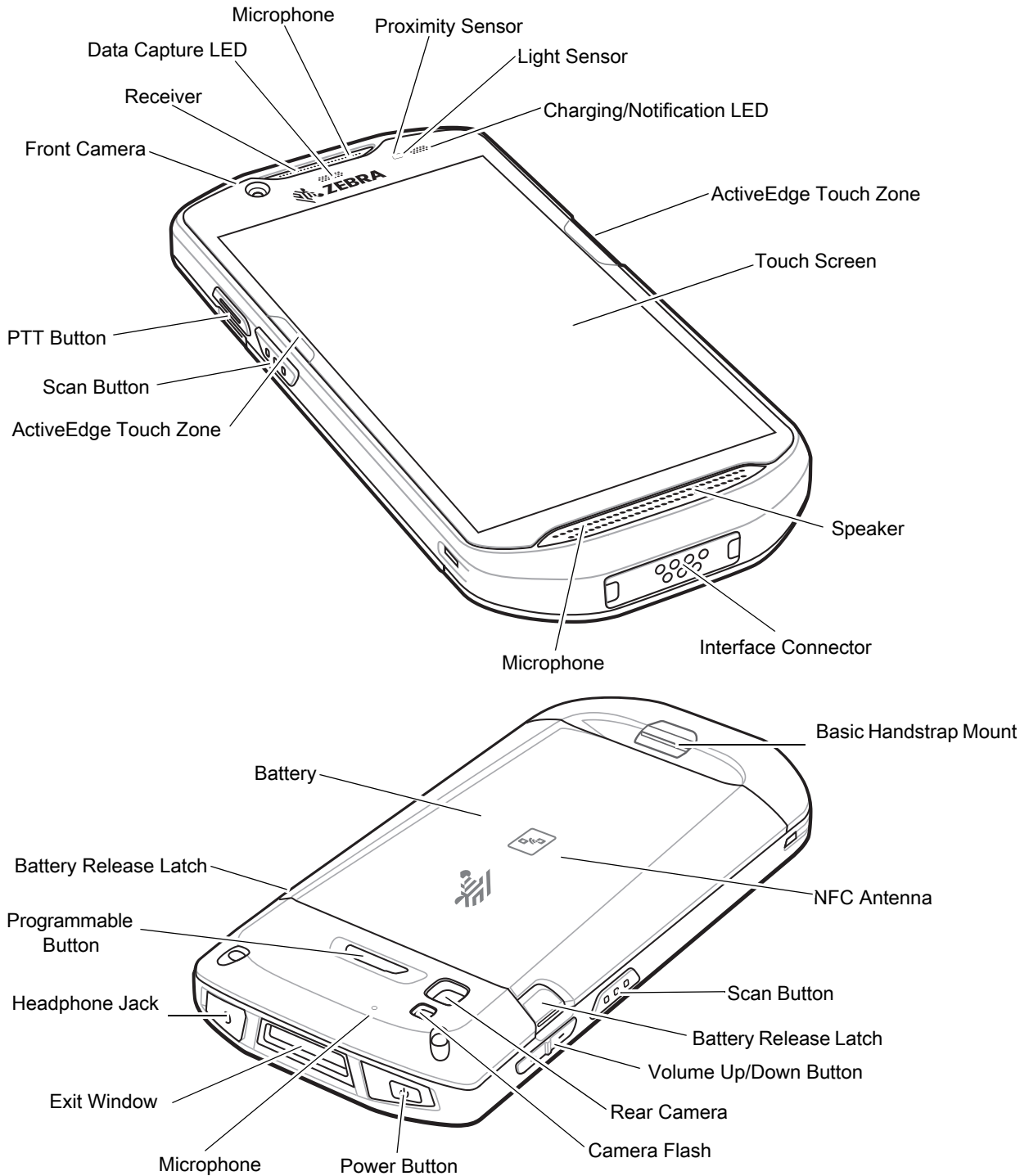

Installing a microSD Card

The microSD card slot provides secondary non-volatile storage. The slot is located under the battery pack. Refer to the documentation provided with the card for more information, and follow the manufacturer's recommendations for use.



CAUTION: Follow proper electrostatic discharge (ESD) precautions to avoid damaging the microSD card. Proper ESD precautions include, but are not limited to, working on an ESD mat and ensuring that the operator is properly grounded.

1. Lift the access door.

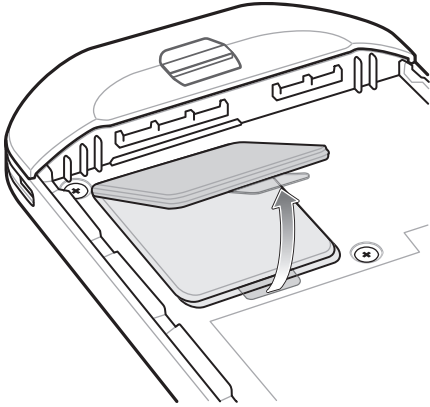

2. Slide the microSD card holder to the unlock position.

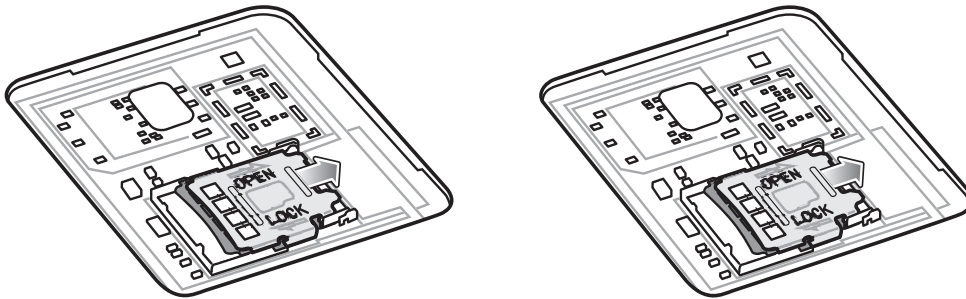

3. Lift the microSD card holder.
4. Insert the microSD card into the card holder door ensuring that the card slides into the holding tabs on each side of the door.

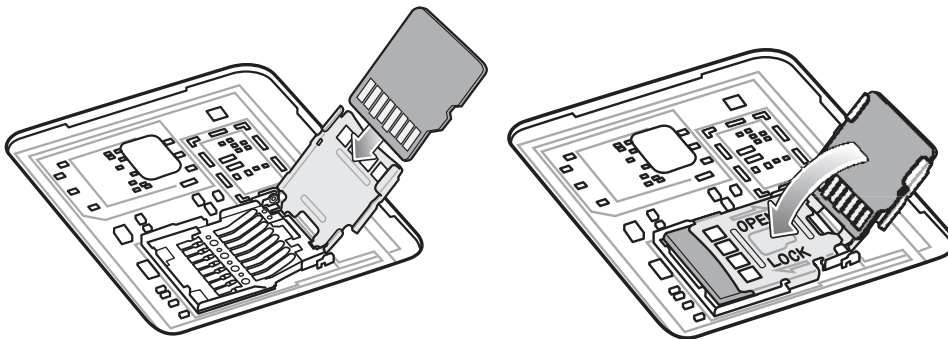

5. Close the microSD card holder and lock into position.



CAUTION: Access door must be replaced and securely seated to ensure proper device sealing.

6. Re-install the access door.

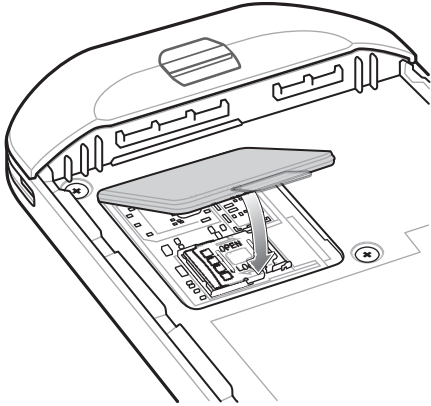

Installing the Battery

To install the battery:

1. Insert the battery, bottom first, into the battery compartment in the back of the device.
2. Press the battery down until it snaps into place.

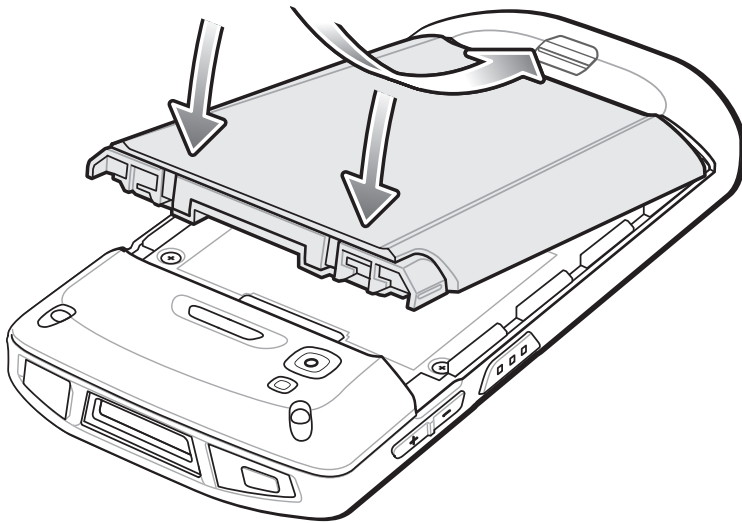

Charging the Device

Use one of the following accessories to charge the device and/or spare battery.

Table 1 *Charging and Communication*

Description	Part Number	Charging		Communication	
		Battery (In Device)	Spare Battery	USB	Ethernet
1-Slot USB/Charge Only Cradle Kit	CRD-TC51-1SCU-01	Yes	No	Yes	With Optional Module
5-Slot Charge Only Cradle Kit	CRD-TC51-5SCHG-01	Yes	No	No	No
4-Slot Charge Only Cradle with Battery Charger Kit	CRD-TC51-5SC4B-01	Yes	Yes	No	No
5-Slot Ethernet Cradle Kit	CRD-TC51-5SETH-01	Yes	No	No	Yes
4-Slot Battery Charger Kit	SAC-TC51-4SCHG-01	No	Yes	No	No
Rugged Charge/USB Cable	CBL-TC51-USB1-01	Yes	No	Yes	No

Charging the Device



NOTE: Ensure that you follow the guidelines for battery safety described in the TC52 User Guide for Android 8.1.0 Oreo.

Battery: 4,300 mAh (typical) / 4,050 mAh (minimum) PowerPrecision+ Lithium-ion battery

1. To charge the main battery, connect the charging accessory to the appropriate power source.
2. Insert the device into a cradle or attach to a cable. The device turns on and begins charging. The Charging/Notification LED blinks amber while charging, then turns solid green when fully charged.

The battery charges from fully depleted to 90% in approximately 2.5 hours and from fully depleted to 100% in approximately three hours. In many cases the 90% charge provides plenty of charge for daily use. A full 100% charge lasts for approximately 14 hours of use. To achieve the best charging results use only Zebra charging accessories and batteries. Charge batteries at room temperature with the device in sleep mode.







Charging the Spare Battery

1. Insert a spare battery into the spare battery slot.
2. Ensure the battery is seated properly.

The Spare Battery Charging LED blinks indicating charging. See Table 2 for charging indicators.

The battery charges from fully depleted to 90% in approximately 2.3 hours and from fully depleted to 100% in approximately three hours. In many cases the 90% charge provides plenty of charge for daily use. A full 100% charge lasts for approximately 14 hours of use. To achieve the best charging results use only Zebra charging accessories and batteries.

Table 2 Charging/Notification LED Charging Indicators

State	LED	Indication
Off		Device is not charging. Device is not inserted correctly in the cradle or connected to a power source. Charger/cradle is not powered.
Slow Blinking Amber (1 blink every 4 seconds)		Device is charging.
Slow Blinking Red (1 blink every 4 seconds)		Device is charging but the battery is at end of useful life.
Solid Green		Charging complete.
Solid Red		Charging complete but the battery is at end of useful life.
Fast Blinking Amber (2 blinks/second)		Charging error, e.g.: <ul style="list-style-type: none"> • Temperature is too low or too high. • Charging has gone on too long without completion (typically eight hours).
Fast Blinking Red (2 blinks/second)		Charging error but the battery is at end of useful life., e.g.: <ul style="list-style-type: none"> • Temperature is too low or too high. • Charging has gone on too long without completion (typically eight hours).

Charge batteries in temperatures from 5°C to 40°C (41°F to 104°F). The device or cradle always performs battery charging in a safe and intelligent manner. At higher temperatures (e.g. approximately +37°C (+98°F)) the device or cradle may for small periods of time alternately enable and disable battery charging to keep the battery at acceptable temperatures. The device and cradle indicates when charging is disabled due to abnormal temperatures via its LED.

1-Slot USB Charging Cradle

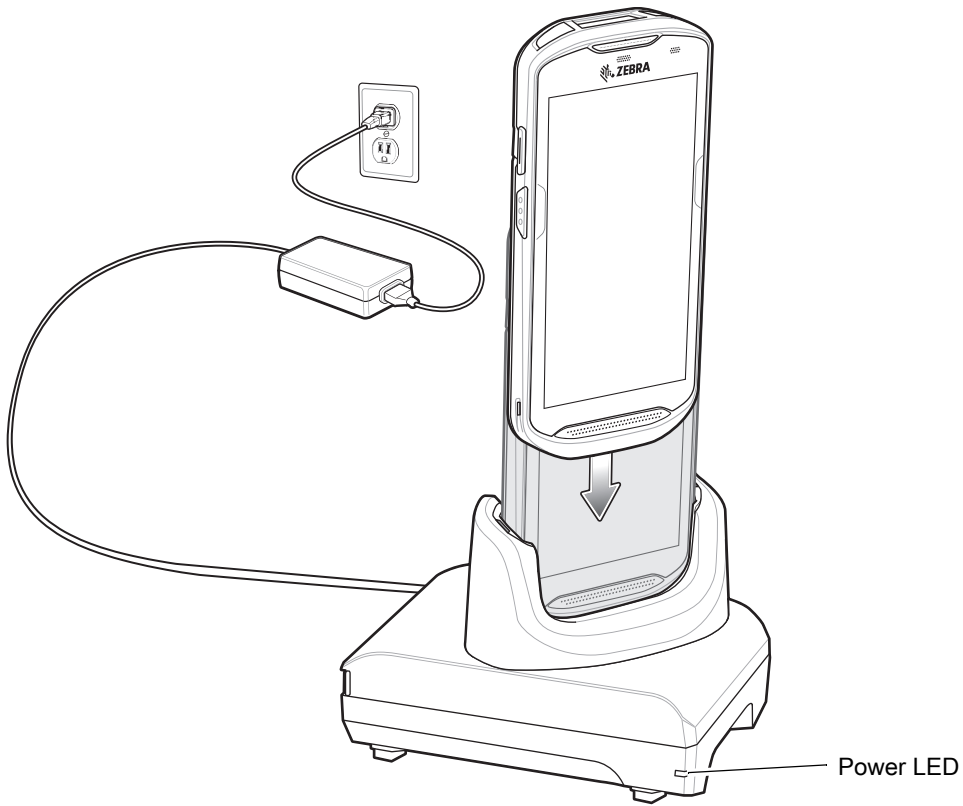

5-Slot Charge Only Cradle

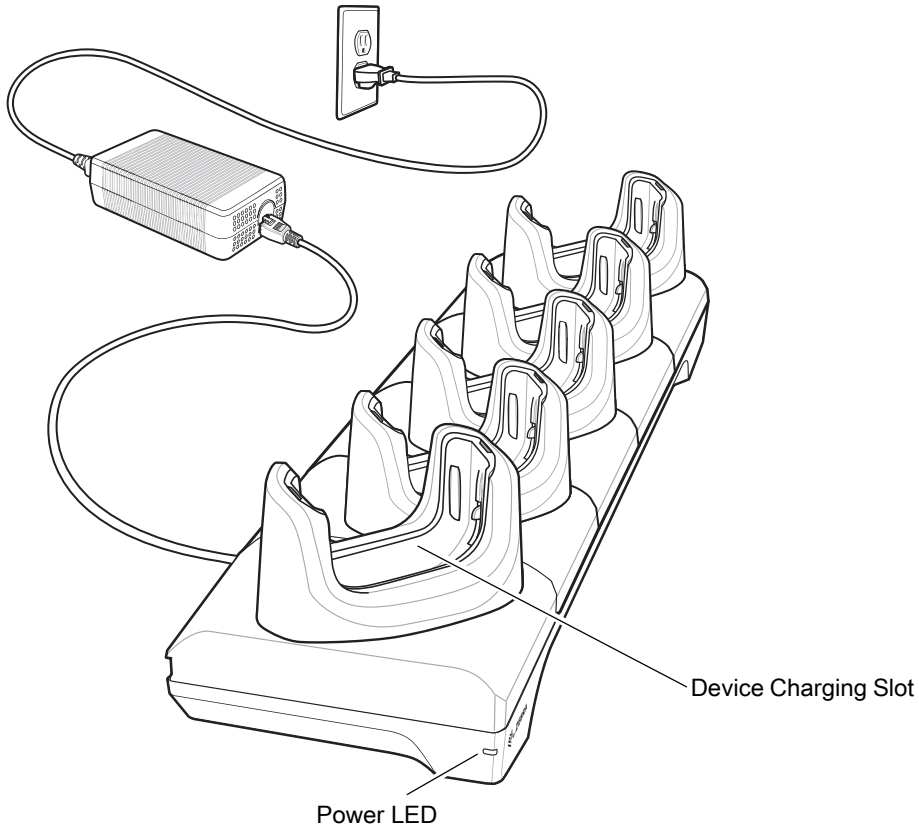

4-Slot Charge Only Cradle with Battery Charger

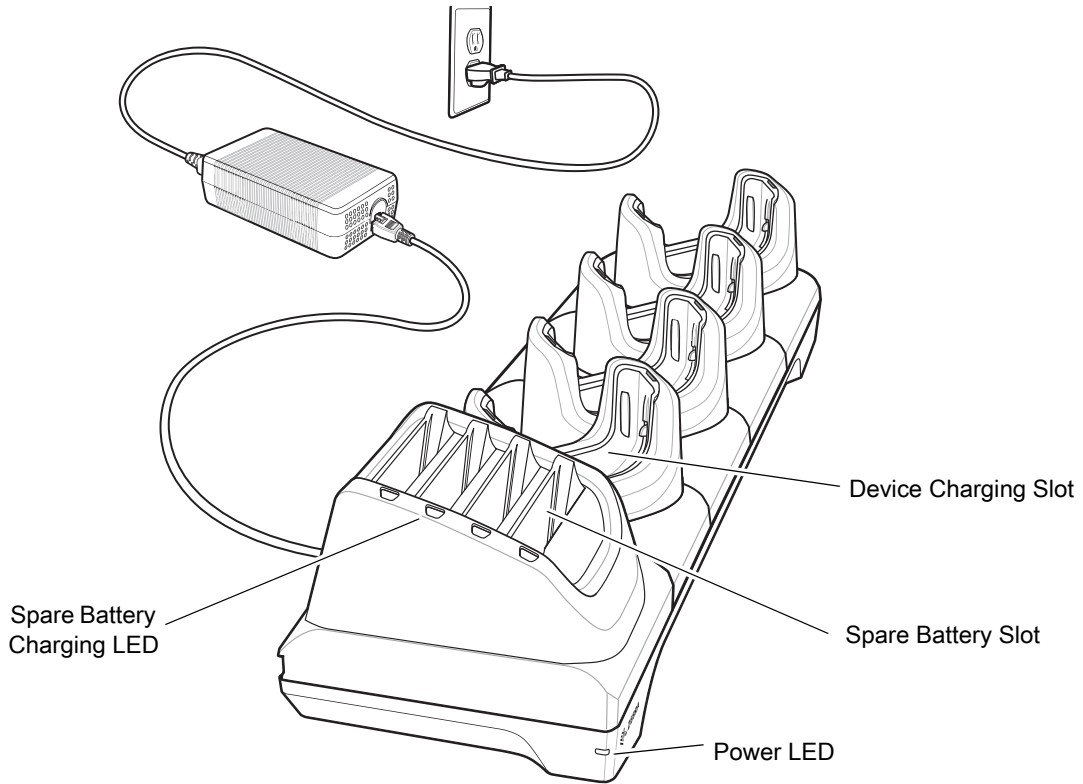

5-Slot Ethernet Cradle

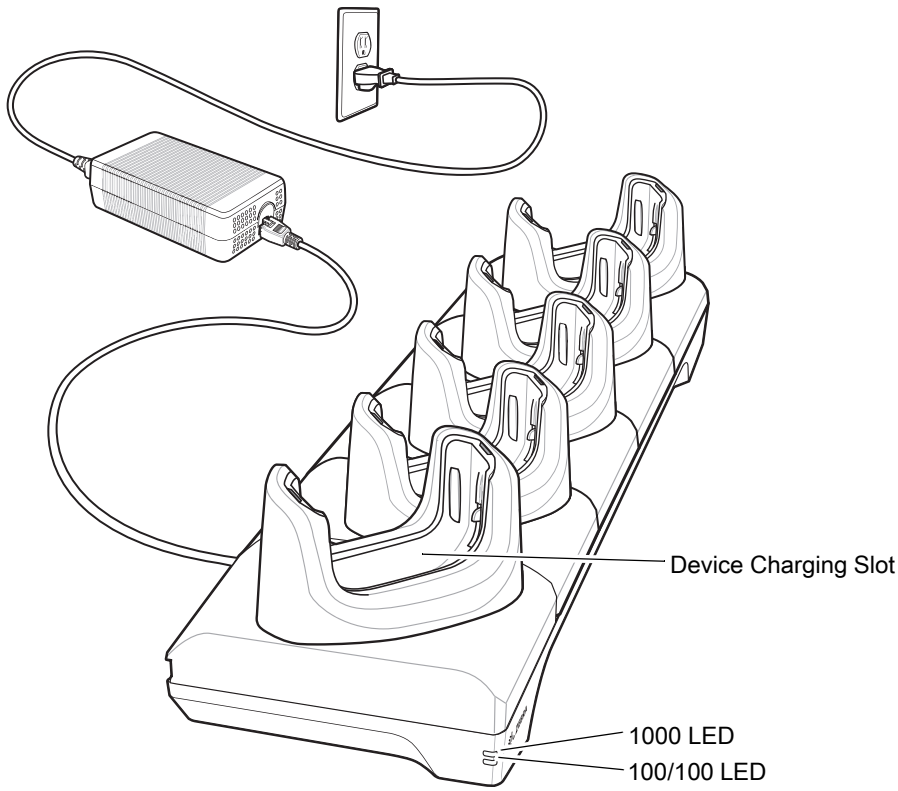

4-Slot Battery Charger

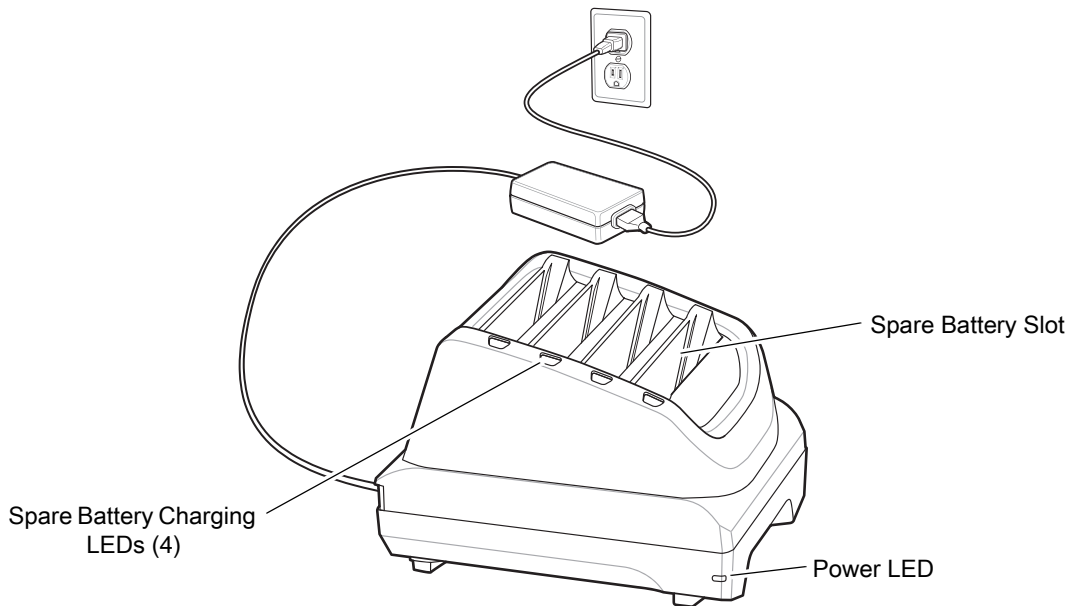

Rugged Charge/USB Cable

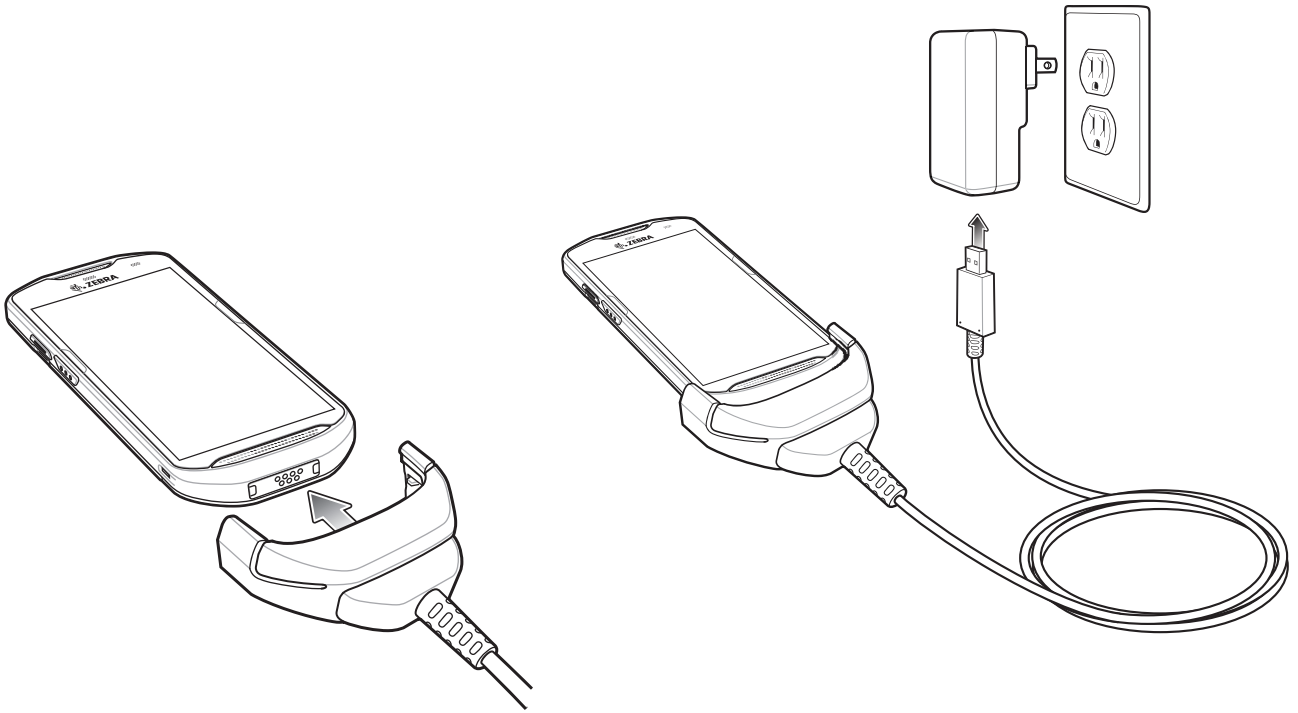

Scanning

To read a barcode, a scan-enabled application is required. The device contains the DataWedge application that allows the user to enable the imager, decode the barcode data and display the barcode content.

1. Ensure that an application is open on the device and a text field is in focus (text cursor in text field).
2. Point the exit window on the top of the device at a barcode.

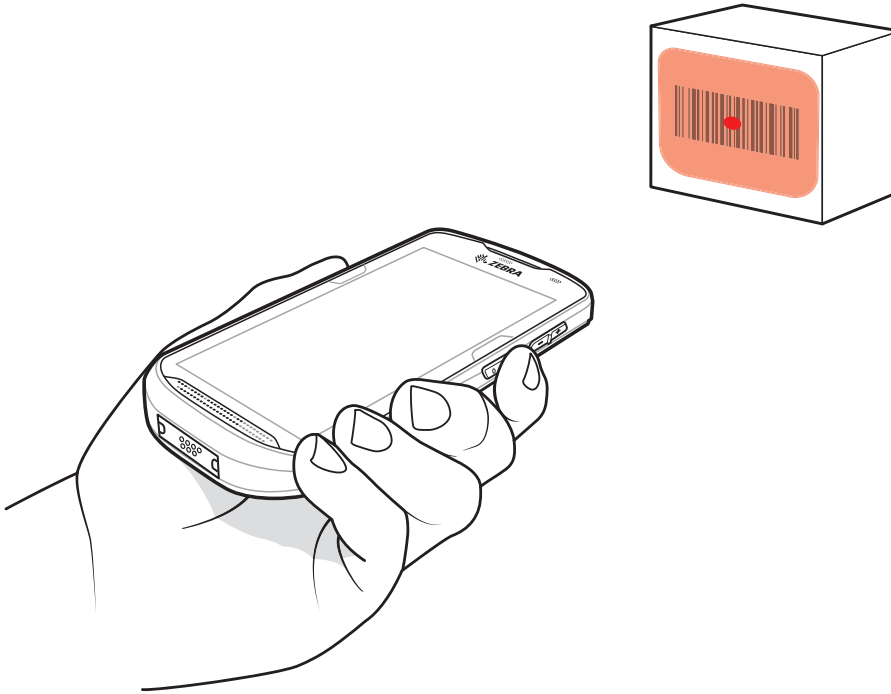

3. Press and hold the scan button.
The red LED aiming pattern turns on to assist in aiming.



NOTE: When the device is in Picklist mode, the imager does not decode the barcode until the crosshair or aiming dot touches the barcode.

4. Ensure the barcode is within the area formed by the cross-hairs in the aiming pattern. The aiming dot is used for increased visibility in bright lighting conditions.



Aiming Pattern

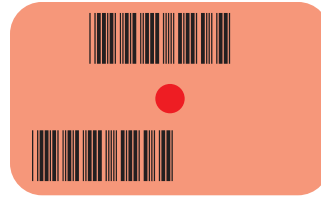
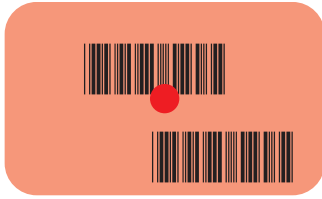

Pick List Mode with Multiple Barcodes in Aiming Pattern

5. The Data Capture LED lights green and a beep sounds, by default, to indicate the barcode was decoded successfully.
6. Release the scan button.



NOTE: Imager decoding usually occurs instantaneously. The device repeats the steps required to take a digital picture (image) of a poor or difficult barcode as long as the scan button remains pressed.

7. The barcode content data displays in the text field.

Ergonomic Considerations

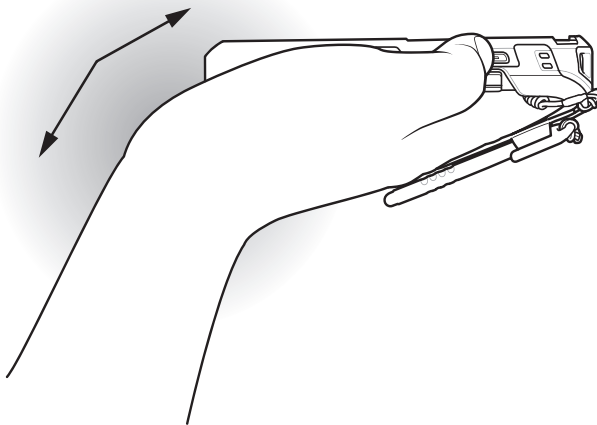
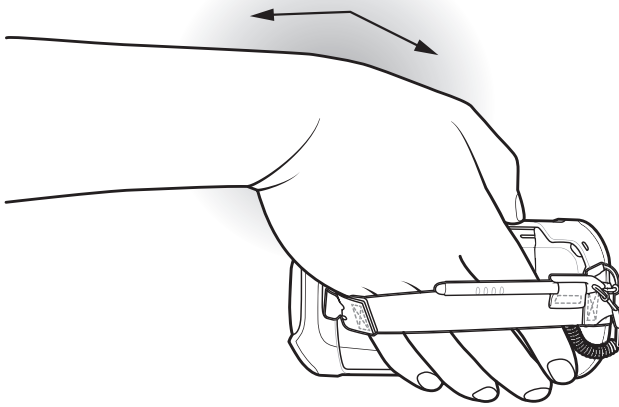

AVOID EXTREME
WRIST ANGLES

